

# Data Center Monitoring unit VT855tt

# VT855tt / Data Center Monitoring Unit

Monitor 130 sensors, 1000 elements,  
Redundant Power & Network

Perfect for monitoring  
IT rooms & Data Centers

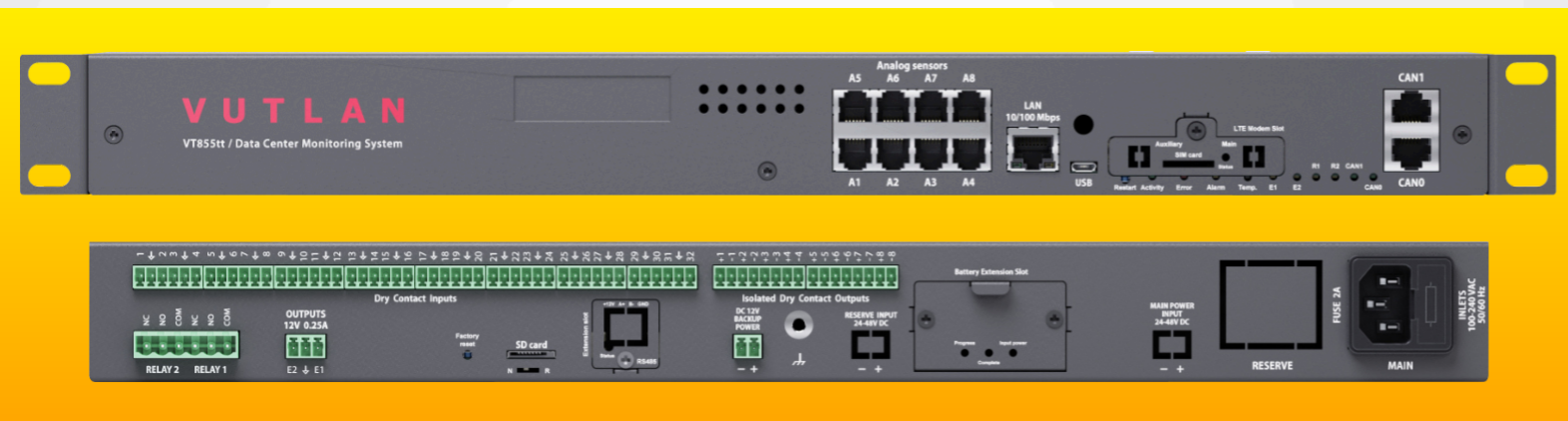

## Specifications

CPU Speed / RAM / OS	2 cores, 720mHz / 128Mb / Linux v.6.2
Ethernet	10/100Mbps
Redundant power	x2 100-240V AC 50/60Hz inputs, x1 12V DC Other order options exist (e.g. 24-48V DC)
USB port	For USB camera, USB flash, USB hub
Analog ports	x8 ports for sensors (extendable)
CAN port	x1 port (max. 32 sensors & extensions)
Dry Contact inputs	x32 dry contact inputs
Dry Contact outputs	x8 dry contact outputs
Relays (12V DC)	x2 outputs, 0.25A each
Relays (NC/NO/COM)	x2 bistable power relays terminals
SD card slot	Up to 512 Gb SDHC
LTE slot modem	Ethernet, SMS, GPS (VT740 ordered separately)
Mounting	19" 1U (brackets included)
Extension slot	VT485m / Modbus RTU extension slot or VT485r / OSDPV2 reader extension slot
Battery extension slot	VT-ACCU / Rechargeable reservation battery or VT-BAT / Reservation battery 6F22 9V
Warranty	3 years
Support	On-line portal

## Supports

- Centralized Monitoring & Control**
  - Responsive Web Interface
  - SNMP v1, v2c, v3
- Scalability**
  - Extension units, LTE modem, OSDPV2, Modbus RTU
  - Modbus TCP/IP, 4-20mA, 0-10V, Analog, CAN
- Improved security**
  - OpenVPN, SSL, HTTPS
  - Three-tier data access permissions with login
- Protocol support**
  - DHCP, HTTP, HTTPS, DynDNS, SMTP, RADIUS, Syslog, NTP server, HTTP request
- API Application Programming Interface**
  - XML, JSON
- System Usability**
  - Multi-language mobile interface
  - First-time wizard
  - Sensor graphing for single and multiple sensors
- Virtual sensors / devices / elements**
  - PING, Timers, Triggers, Logic schemes, SNMP GET
  - IP cameras, Groups, Math
- Notifications and alerts**
  - E-mail, SMS, Phone dial, SNMP Traps, Web-to-SMS, SMS link
- Logging**
  - SD card, USB flash, E-mail, FTP

## Example connections

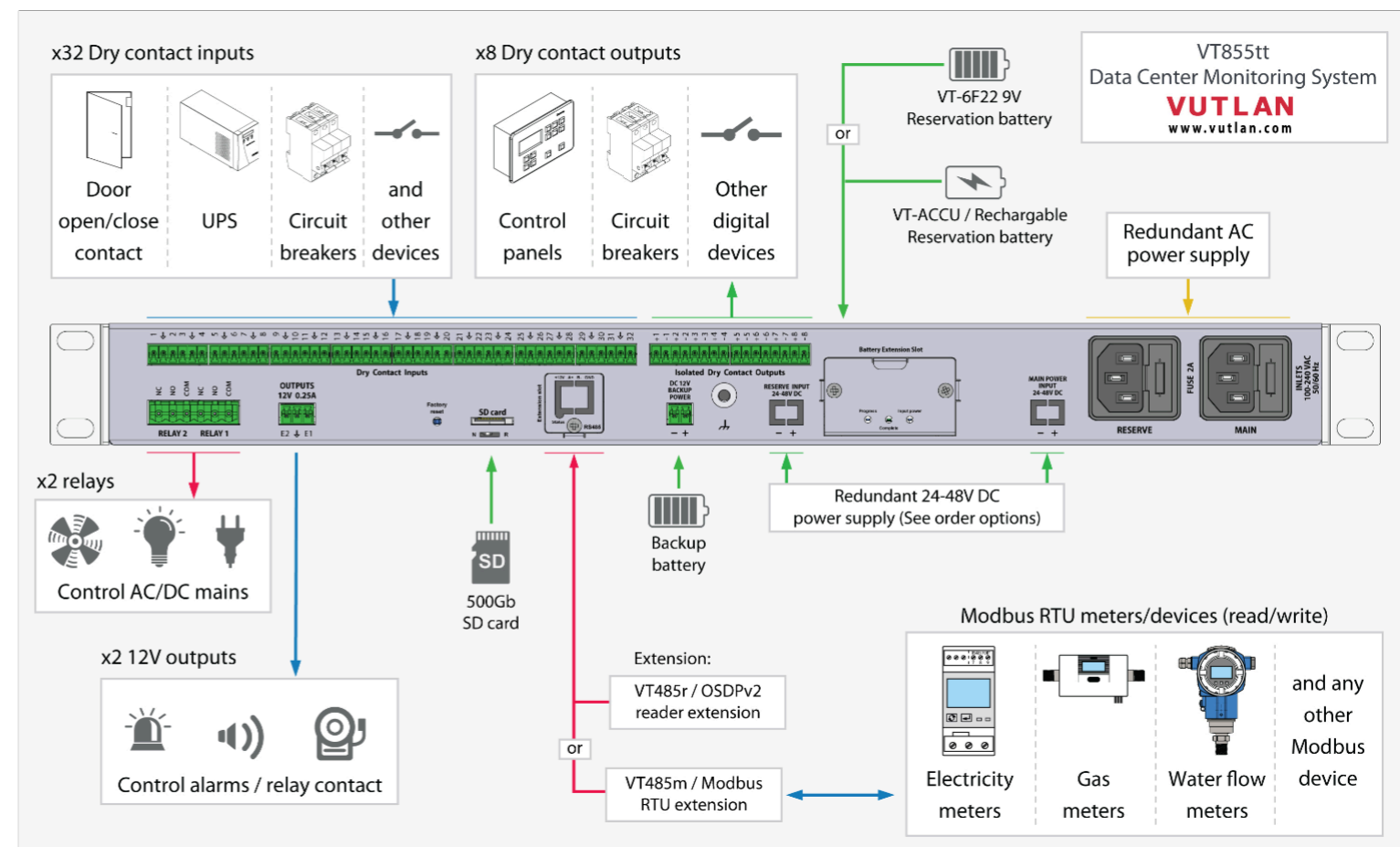
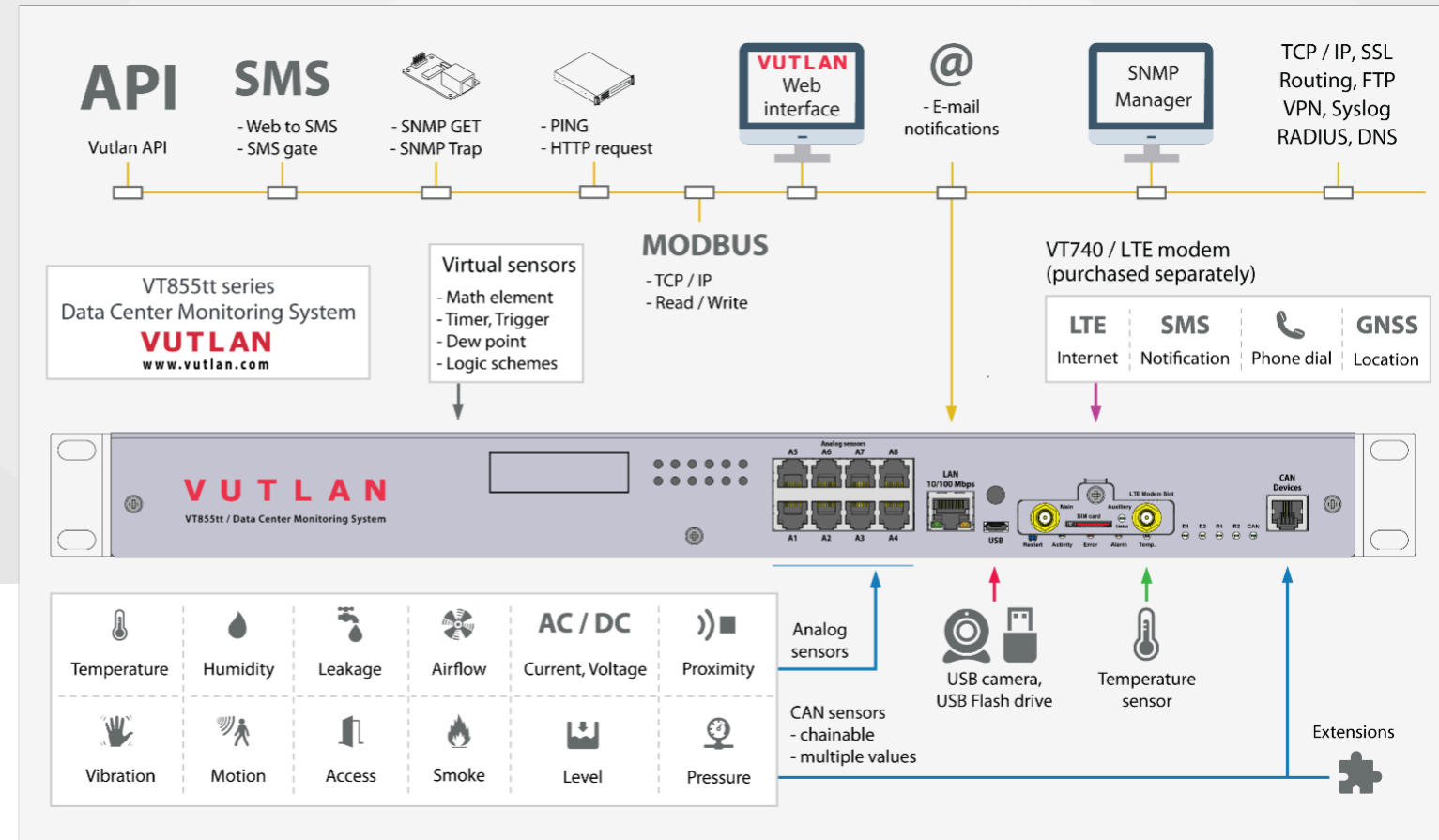



## Embedded Web Interface

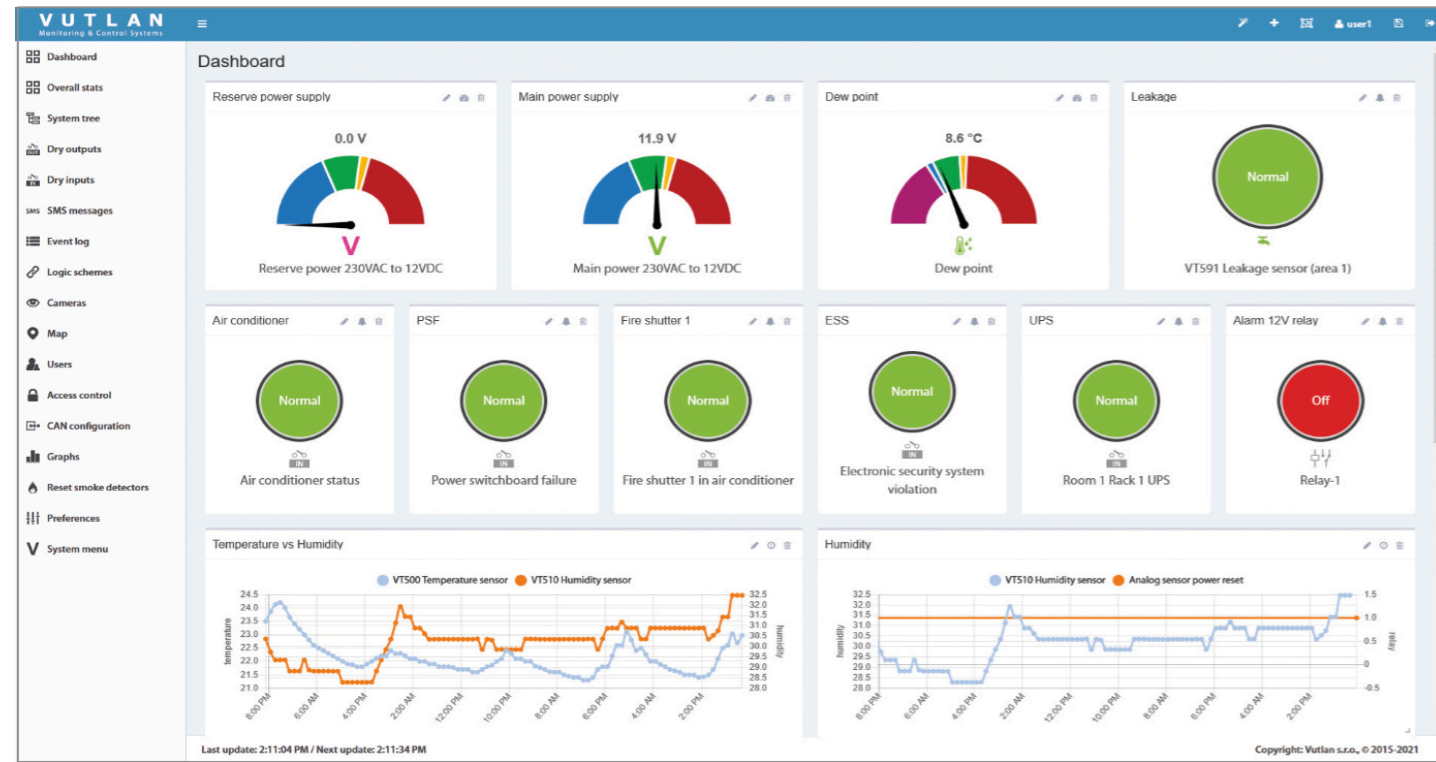

### Monitor & Control:

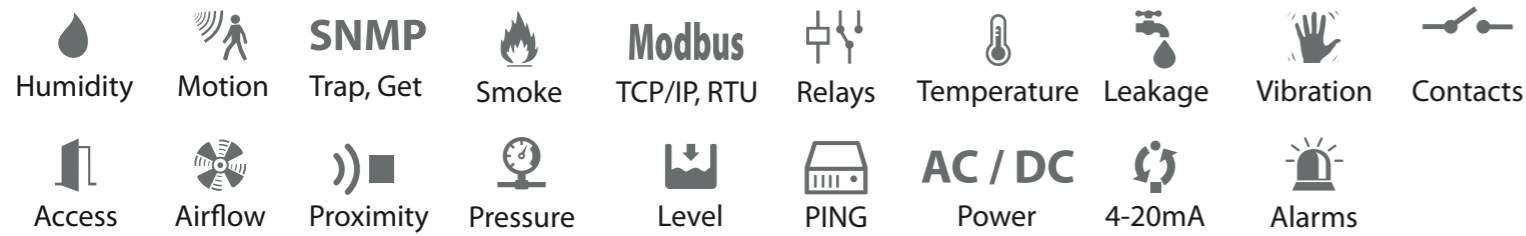

## VT825t dimensions

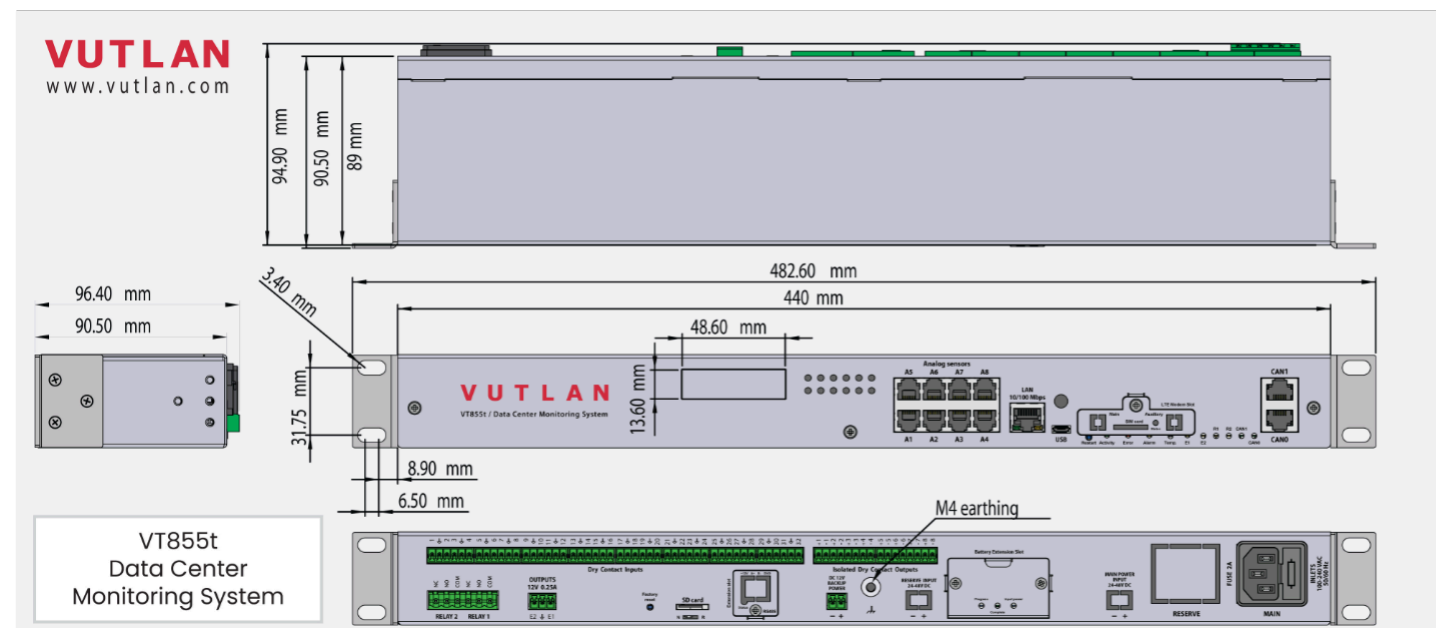

## VT485m / Modbus RTU extension or VT485r / OSDPV2 reader extension

Ordered separately

Ordered separately

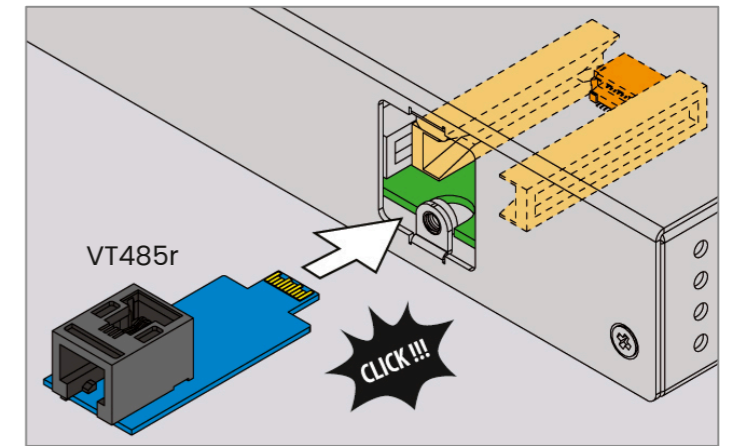
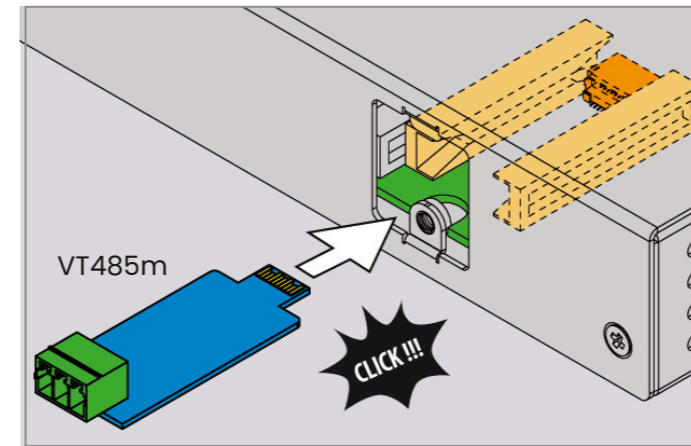

## VT740 / LTE slot modem

Ordered separately

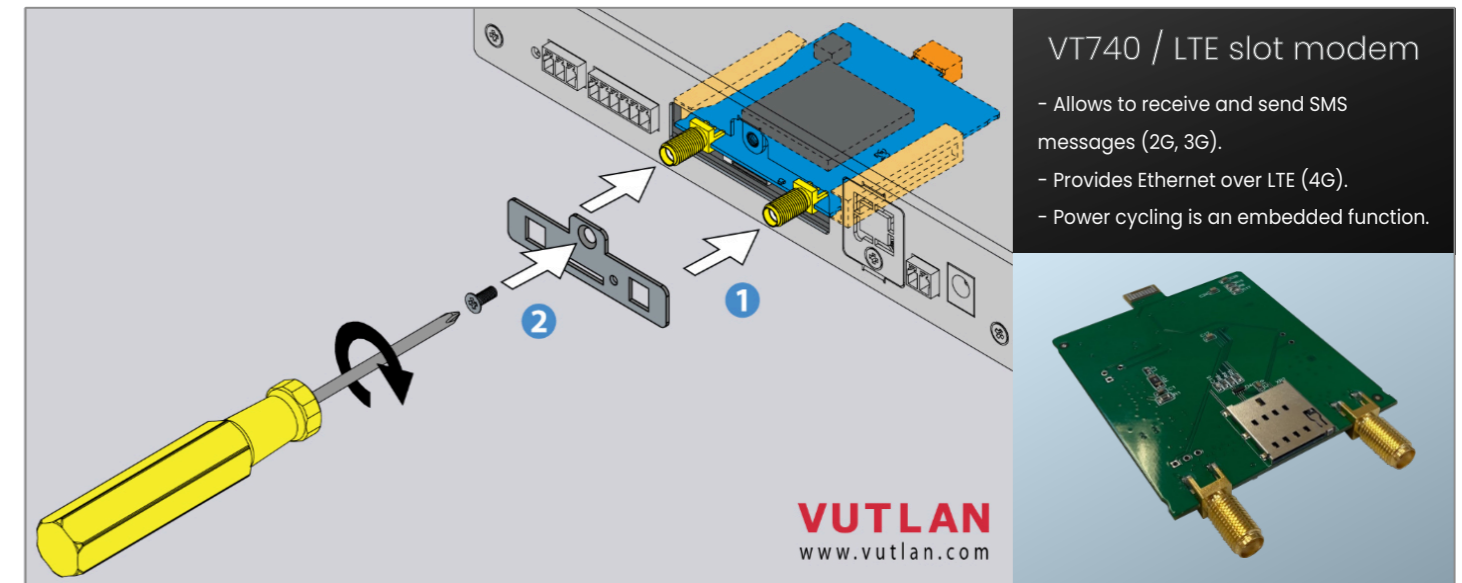

## VT-BAT / Reservation battery 6F22 9V or VT-ACCU / Rechargeable reservation battery

Ordered separately

Ordered separately

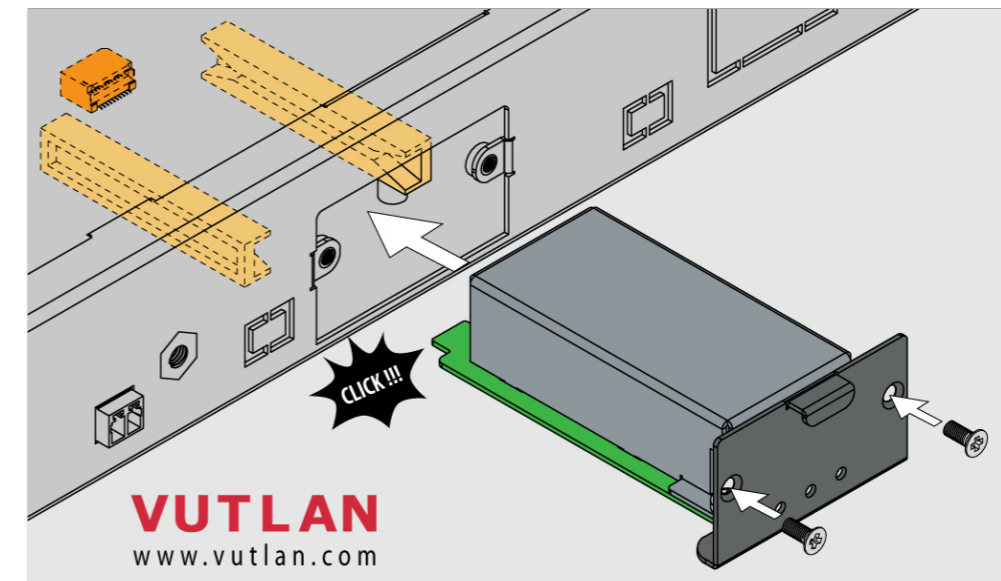



## Leakage detection

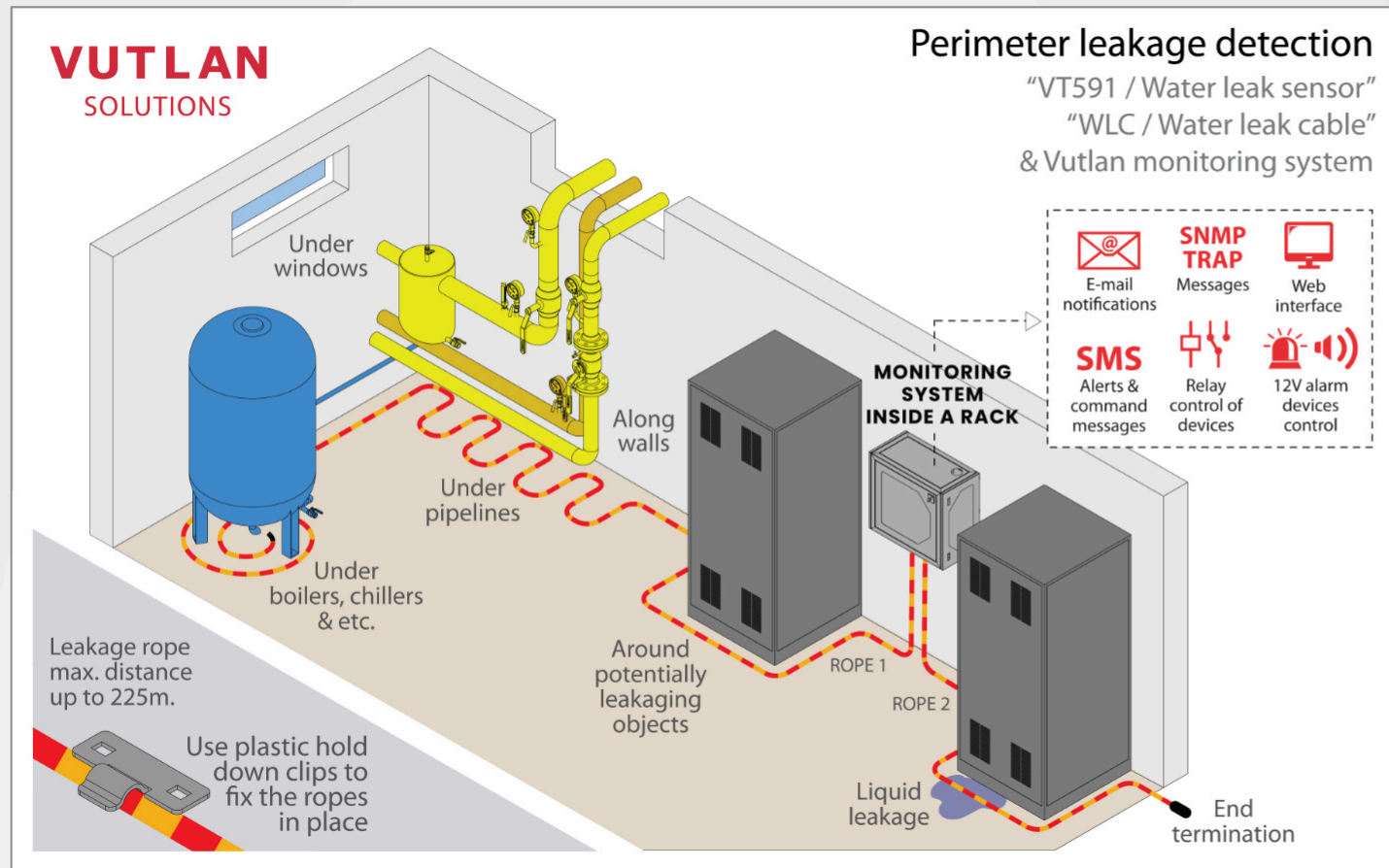

## Measure AC voltage 0-246V

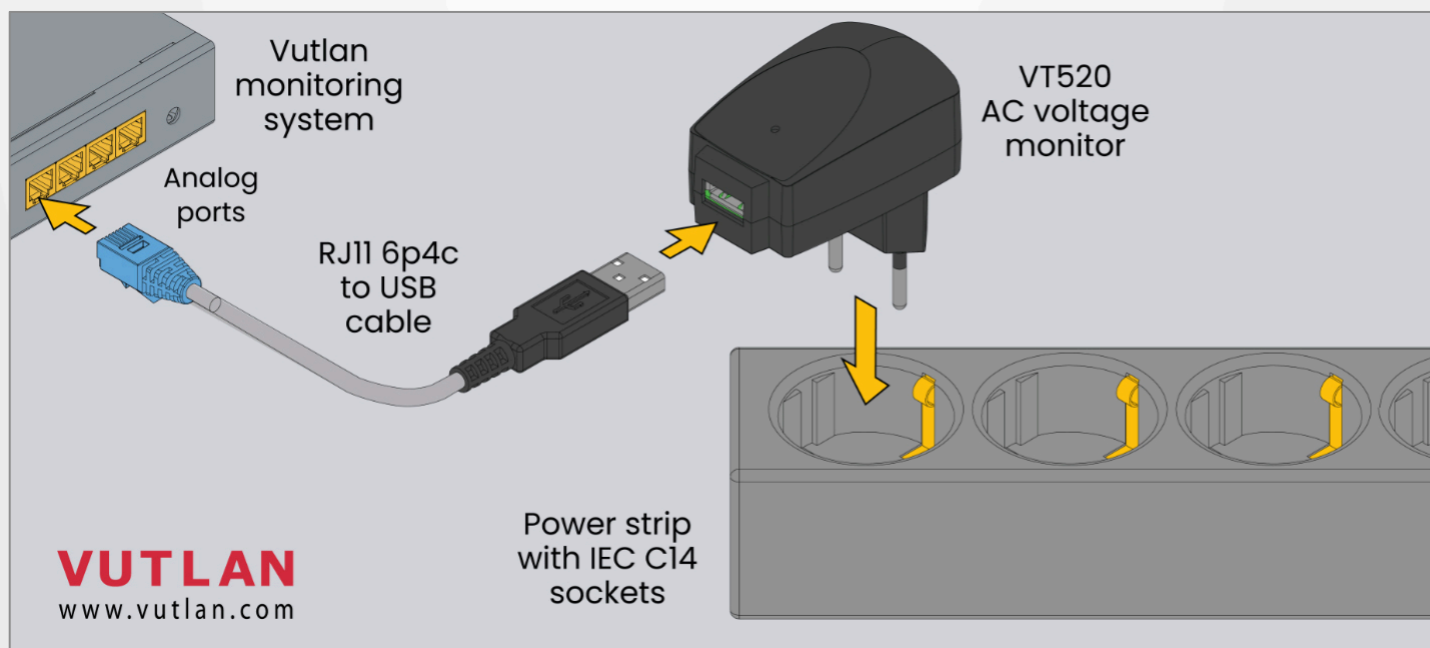

## VT485m / Modbus RTU extension

Ordered separately

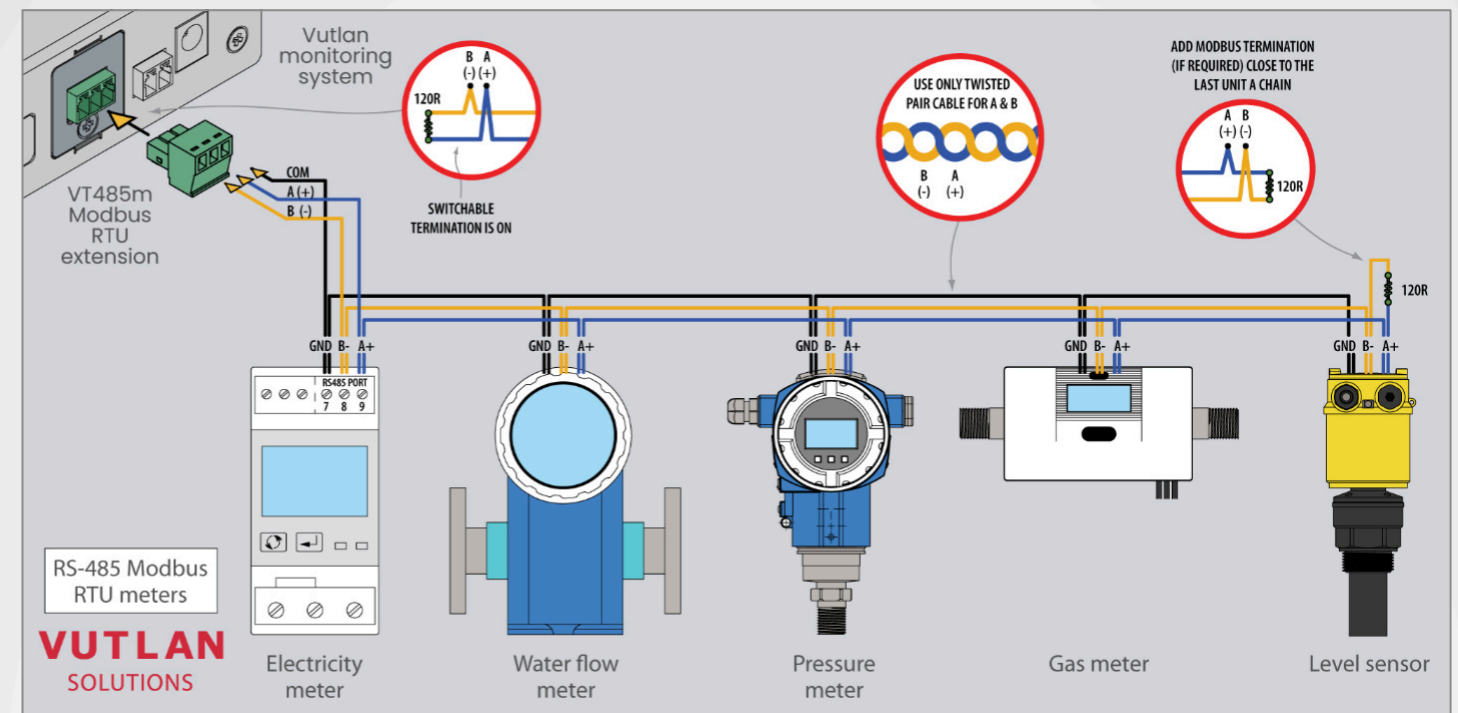

## Server Rack & Data Center monitoring

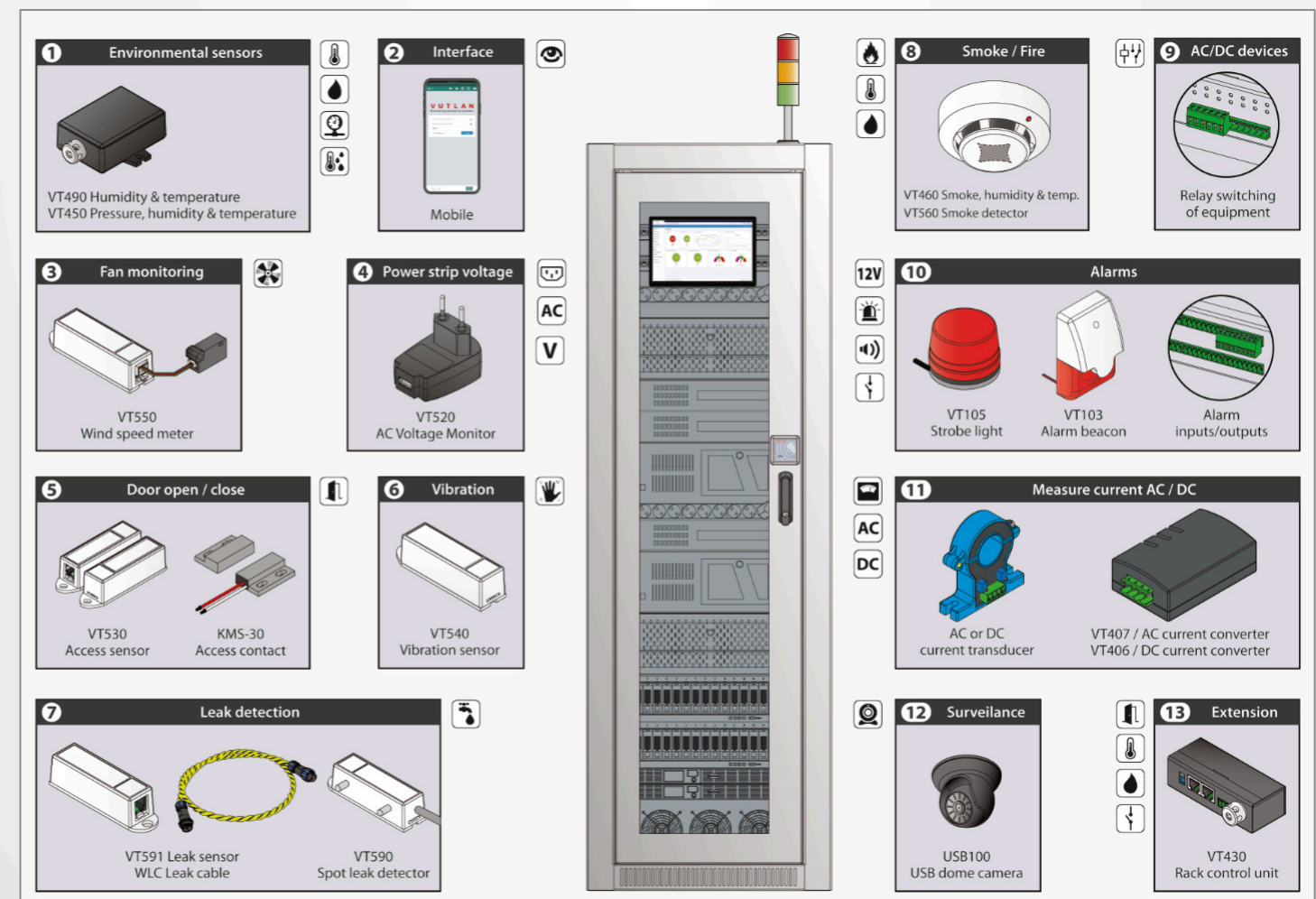





# Vutlan Partner Network

Vutlan is working with Distributors,  
Solution Providers and Integrators  
all around the world.

**65+**  
PARTNERS

**+37**  
COUNTRIES

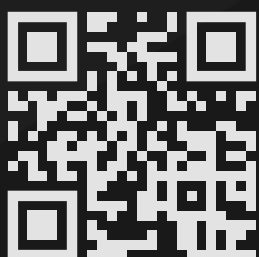

Vutlan s.r.o. (LTD)  
43 ul.Svornosti,  
82106, Bratislava,  
Slovak Republic, EU  
sales@vutlan.com  
www.vutlan.com

# VUTLAN