

# CATALOGUE

2015



PRODUCTS AND SYSTEMS  
FOR ELECTRICAL AND DIGITAL BUILDING INFRASTRUCTURES

 **legrand**<sup>®</sup>

**MCBs, RCDs  
& DIN rail equipment**



**P. 40**  
RX<sup>3</sup> MCBs  
up to 63 A



**P. 44**  
TX<sup>3</sup> MCBs  
up to 63 A

**ACBs, MCCBs, head equipment  
& energy compensation**



**P. 85**  
EMDX<sup>3</sup>  
multi-function  
measuring units



**P. 94**  
Alpicap  
capacitors

**Enclosures**



**P. 192**  
British standard  
consumer units



**P. 194**  
Nedbox  
cabinets

**Equipment & accessories**



**P. 280**  
Viking 3  
terminal blocks



**P. 302**  
Osmoz  
control &  
signalling units

**Arteor wiring accessories**



**P. 360**  
Arteor  
mechanical and electronic  
switches



**P. 369**  
Arteor  
international  
socket outlets

**Home Automation  
and Home Network**



**P. 402**  
Arteor  
Radio/Zigbee  
key cover  
selection charts



**P. 408**  
Arteor BUS/SCS  
key cover  
selection charts

**Other wiring accessories**



**P. 436**  
Kaptika  
flush-mounting



**P. 438**  
Forix  
surface-mounting

**British standard wiring accessories**



**P. 494**  
Belanko



**P. 500**  
Mallia  
complete  
white

**Weatherproof wiring accessories  
and other installation equipment**



**P. 548**  
Plexo IP 55  
and Plexo 66



**P. 556**  
Soliroc  
IK 10

**Lighting management, emergency  
lighting, access control & CCTV**



**P. 592**  
Lighting  
management  
solutions



**P. 602**  
Weatherproof and  
vandal-resistant  
bulkhead lights

**UPS, LCS<sup>2</sup> & cable  
management systems**



**P. 654**  
UPS: Daker, Niky,  
Niky S & Keor  
multiplug



**P. 668**  
Cat.6A, 6 and 5e  
patch panels, RJ 45  
sockets and area  
distribution boxes

**Mosaic wiring accessories  
& Healthcare buildings**



**P. 784**  
Lighting, temperature  
and roller blind  
controls



**P. 792**  
International  
standards socket  
outlets and USB  
chargers



**P. 52**  
DX<sup>3</sup> MCBs  
up to 125 A



**P. 62**  
Voltage surge  
protectors



**P. 74**  
Programmable  
time switches



**P. 80**  
Transformers  
buzzers and bells



**P. 106**  
DRX  
125/250/630  
MCCBs up to  
630 A



**P. 120**  
DPX<sup>3</sup>  
160/250/630/1600  
MCCBs  
up to 1600 A



**P. 140**  
DMX<sup>3</sup>  
2500/4000/6300  
ACBs  
up to 6300 A



**P. 185**  
Flat copper  
busbars &  
accessories



**P. 196**  
XL<sup>3</sup> 125  
distribution  
cabinets



**P. 197**  
XL<sup>3</sup> 125/250  
distribution  
boards



**P. 198**  
XL<sup>3</sup> 160/400/800/  
4000 and 6300  
distribution cabinets



**P. 240**  
Weatherproof  
cabinets: Plexo<sup>3</sup>,  
Atlantic, Atlantic-E,  
Marina



**P. 312**  
Control, safety  
& circuit isolation  
transformers



**P. 326**  
P 17 Tempra  
Pro industrial  
sockets & plugs



**P. 340**  
Hypra industrial  
sockets & plugs



**P. 348**  
Bells for industrial  
& alarm use



**P. 372**  
Arteor  
USB chargers



**P. 381**  
Arteor  
audio and video  
sockets



**P. 386**  
Arteor  
plates



**P. 395**  
Arteor  
hotel equipment



**P. 409**  
Arteor BUS/SCS  
lighting control  
and automation



**P. 421**  
Arteor  
home system



**P. 424**  
Home  
Network



**P. 432**  
FttH  
Fiber  
to the home



**P. 442**  
Niloé



**P. 452**  
Valena



**P. 466**  
Galea Life

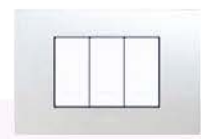

**P. 484**  
Vela



**P. 507**  
Mallia  
customisable  
colours



**P. 517**  
Synergy



**P. 540**  
Synergy  
Metalclad



**P. 544**  
Synergy  
Grid system



**P. 565**  
Flush-mounting  
boxes



**P. 570**  
Installation  
equipment  
and connection



**P. 574**  
Special plugs  
and extensions



**P. 581**  
Door entry  
system  
and detection



**P. 606**  
Emergency  
lighting luminaires  
and LVS2 system



**P. 621**  
Access control kits,  
keypads and badge  
readers



**P. 628**  
Smart Security  
system



**P. 636**  
CCTV kits  
and cameras,  
fire detection  
solutions



**P. 684**  
Fibre optic and  
audio/video  
system



**P. 698**  
Freestanding and  
wall-mounting  
cabinets, PDU  
and bati-rack



**P. 732**  
DLP cable  
management  
solutions



**P. 767**  
Workstation  
systems



**P. 795**  
RJ 45, data,  
telephone, TV  
and audio/video  
sockets



**P. 801**  
Wi-Fi access  
points and  
illuminated signs



**P. 803**  
Antimicrobial  
call/nurse call  
units and control  
units



**P. 809**  
Antimicrobial  
trunking and  
bedhead strips,  
transformers

# QR codes

QR codes give you access to even more up-to-date information such as: certifications, standards, technical guides, data sheets, spare parts...

## to get more & quick information

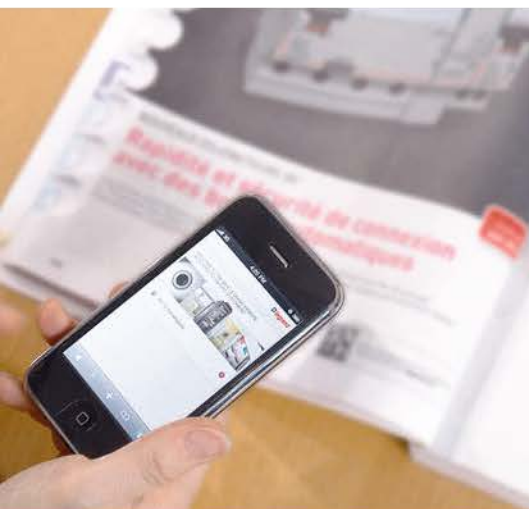

### > How it works

Interactive and simple to use. You just scan the QR code corresponding to the solution you are interested in and you are taken directly to the relevant information from your smartphone (equipped with a camera and an appropriate decoding application).

- 1 - Scan the code in the catalogue
- 2 - Receive the information directly
- 3 - Access the information



Test me!



### MORE DIGITAL MEDIA



#### e-catalogue web

Up-to-date, easy to access information on all products: characteristics, certificates and standards, guides and technical data sheets, price lists, etc.



#### m.ecatalogue-exp.legrand.com: for smartphones and tablets

On-site, when visiting a customer or between meetings, you can access all the information of the e-catalogue on your smartphone\*.

\*Compatible with smartphones and tablets equipped with a web navigator (free access to the service excluding cost of connection of the operator).

# Alphabetical list

## A

ACBs	
DMX <sup>3</sup>	140 to 145
Access control	
Arteor	622 to 627
Galea Life	469
Programme Mosaic	621 to 627
Soliroc	556
Access unit	772
Adaptors	
for industrial sockets	327
multi-outlets	575
Plexo 55 for Programme Mosaic	803
Add-on modules (MCBs)	58
Alpibloc fixed capacitor banks	97
Alpican capacitors	94
Alpimatic	
automatic capacitor banks	100
racks	98
Alptec power factor controllers	103
Alpivar <sup>2</sup> capacitor banks	96
Altis freestanding cabinet	712
Aluminium columns	767 to 771
American standard socket outlets	
Arteor	370
Programme Mosaic	793
Ammeters	
on door	93
on rail	92
Angled plugs (Hypra)	340 to 347
Appliance inlets	
Hypra	340 to 347
P17 Temptra	326 to 335
Arteor	
access control	622 to 627
audio/video sockets	381
automatic switches	419
blank modules	383
blanking cover plates	383
BUS/SCS technology	408 to 422
door entry system	422
energy management	420
home management	421
intruder alarm	416, 417
lighting control	408, 409
sound diffusion	418, 419
temperature control	414
cable outlets	383
cooker control units	367
cord outlets	383
data sockets	375, 376
detectors	368
dimmers	364, 365
DP switches	367
emergency lighting unit	367
emergency stop push-buttons	367
Ethernet switch	693
fused connection units	369
hotel equipment	395 to 399
international standard socket outlets	369 to 371
IP 44 plate	385
lighting units	367
MCBs	368
plates selection chart	386 to 393
push-buttons	363
Radio/ZigBee <sup>®</sup> technology	402 to 406
RCBOs	368
roller blinds control	368
shaver sockets	397
single pole latching relay	367
socket outlets	369 to 371
support frames	385
surface-mounting boxes	384
switches	360 to 362
switches for hotels	397
telephone sockets	374
television sockets	374
thermostats	368
time delay switch	367
USB chargers	372

Arteor (continued)	
ventilation control	368
Wi-Fi access point	377
Assistance with independent living (Programme Mosaic)	822
Atlantic metal cabinets	244
Atlantic-E metal cabinets	248
Audio-video	694 to 698
Arteor sockets	381, 382, 694, 695
cables and cords	696
enclosures	698
LCS <sup>2</sup> sockets	694, 695
patch panels	696
Programme Mosaic sockets	798 to 800
Valena sockets	458
Australian standard socket outlets	
Arteor	371
Automatic capacitor banks (Alpimatic)	100
Automatic detectors	649
Automatic staircase time lag switch	77
Automatic switches	
Arteor	366
Galea Life	466
Mallia	502, 509
Niloe	444
Plexo IP 55	550
Valena	454
Vela	485
Automation control unit	138, 144
Auxiliaries for	
DMX <sup>3</sup> , DMX <sup>3</sup> -I	143
DPX-IS, DPX-I	149
DPX <sup>3</sup>	126 and 138
DX <sup>3</sup>	60

## B

B 65 LED	612
B 65 NEW	612
B 66	615
B 66 LED	611
Bars (copper)	185
Batibox flush-mounting boxes	804, 805
Bati-rack	711
Batteries (nickel - cadmium)	617
Beacons	650
Belanko	
cable outlets	498
cooker control unit	495
data sockets	496
dimmers	495
fused connection units	497
plates	498
push-buttons	494
shaver sockets	496
socket outlets	497
surface mounting boxes	498
switches	494, 495
telephone sockets	496
television sockets	496
ventilation control	495
Bells	581
for alarm and industrial use	348, 650
Programme Mosaic	794
pushes	581
Blade type cartridge fuses	160
Blanking plates	
Arteor	383
Galea Life	473
Mallia	514
Programme Mosaic	808
Synergy	521, 527, 533, 539, 540
Valena	460
Vela	484
Blocks (Osmoz)	
electrical	305
Boxes	
flush-mounting boxes	804, 805
for Arteor	384
for industry use	562

Boxes (continued)	
for Programme Mosaic	804, 805
for Plexo IP 55	553
for Synergy (selection chart)	542, 543
for Vela (selection chart)	490, 491
Plexo	558
surface-mounting boxes (see surface-mounting boxes)	
Bridging combs (Viking 3)	285
British standard	
plugs	575
socket outlets	
20 A	548
Arteor	369
Belanko	497
Galea Life	471
Mallia	504, 511
Programme Mosaic	793
Synergy	519, 520, 525, 531, 537, 541
Building management	600, 601
Bulkhead lights	602
BUS/KNX control units	599
Arteor controls	396
BUS/SCS equipment and accessories	597 to 599
Arteor	408 to 422
Busbars supports	187
Buzzers (DIN rail mounting)	80
Arteor	398
Galea Life	469
Programme Mosaic	794
Vela	488

## C

CAB 3	294 to 296
Cabinets	
Atlantic metal	244
Atlantic-E metal	248
Marina	250
Nedbox	194
Plexo <sup>3</sup>	240
Practibox	191
VDI	704, 705
XL <sup>3</sup> 125	196
XL <sup>3</sup> -N 125	197
XL <sup>3</sup> 160	198
XL <sup>3</sup> -N 250	197
XL <sup>3</sup> 400	202 to 209
XL <sup>3</sup> 800	210 to 219
Cable clips	569
Cable ducting	
Lina 25	300
Transcab	299
Cable entries	712
Cable (fibre optic)	684
Cable glands (plastic and metal)	267 to 269
Cable management	701
Cable marking system	
CAB 3	294 to 296
Duplix	571
Memocab	297
Cable outlets	
Arteor	383
Belanko	498
Galea Life	473
Mallia	503, 510
Niloe	446
Programme Mosaic	794
Synergy	521, 527, 533, 538, 540
Valena	460
Cable reels	579
Cable sleeves	
XL <sup>3</sup> 400	204
XL <sup>3</sup> 800	212 to 215
XL <sup>3</sup> 4000	224
Cable ties (with base)	568
Colring	272
Colson	570
VDI	713
Cabstop open-work plates	245

Call points	649
Cam switches	307
Cameras analog	638 to 640
IP	642, 643
Capacitor banks	
Alpibloc	97
Alpican	94
Alpimatic	
(racks and capacitor banks)	98 to 102
Alpivar 2	96
Capvis caps	572
Carrier plates	
(for Synergy Grid system)	542, 543
Cartridge fuses	66, 159, 160
Cat.5	679, 680
Cat.6	672 to 675
Cat.6A	668 to 671
CCTV	
analog camera	638 to 640
analog DVR	641
IP camera	642, 643
monitors	646
NVR	645
software	641
Central measuring units	
on door	85
on rail	84
Changeover switches	
DCX-M	152
DX <sup>3</sup>	73
Chassis	
for Atlantic, Atlantic-E and Marina	259
Chimes	581
Arteor	397
Galea Life	469
Chinese standard socket outlets	
Arteor	371
Clipsotube	568
Coils (residual current)	138
Colour-lighting management	787
Colring cable ties and tools	272
Colson cable ties and tools	570
Columns	767, 768
Combined units	
for refrigerated containers	328
P17 Tempra	336
Conduits	
rigid	568
supports	568
Connectors	183
fibre optic	688
without screws	572
Consumer units	192
Contact switches	580
Contactors	
CTX <sup>3</sup> industrial contactors	170
CX <sup>3</sup> (DIN rail mounting)	70
Control and signalling transformers	312
Control and signalling units Osmoz	302
Control stations Osmoz	306
Control switches and push-buttons	73
Controllers (lighting management)	597
Conversion kits (see Power packs)	620
Cooker control units	
Arteor	367
Belanko	495
Mallia	502, 509
Synergy	521, 527, 532, 538
Copper busbars	185
Cord switches	580
Cord outlets	
Arteor	383
Synergy	527, 533, 539
Vela	484
Cover plates/rocker plates	
Galea Life selection chart	475 to 483
Programme Mosaic	806, 807
Crimping tools (Starfix)	292
Crosspieces Lina 25	256
CTX <sup>3</sup> industrial contactors	170
Current transformers	88
CX <sup>3</sup> power contactors	70

## D

Data sockets	
Arteor	375, 376
Belanko	496
Galea Life	470
Mallia	503, 510
Niloé	446
Programme Mosaic	797
Synergy	518, 524, 529, 535, 540
Valena	456
Vela	487
DCX-M changeover switches	152
Desk grommets	779
Desktop multi-outlet extensions	781
Detectors	
lighting management	592 to 598
movement detector	586
Plexo IP 55	549
Detuned reactors	104
Digital video recorder (DVR)	641
Dimmers	
Arteor	364
Belanko	495
DIN rail mounting	78
Galea Life	468
Grid modules	544, 545
Mallia	502, 509
Niloé	444
Programme Mosaic	787
Synergy	517, 522, 528
Valena	454
Vela	485
Distribution blocks 40 A to 400 A	181
Distribution cabinets, enclosures and equipment	
Nedbox	194
Plexo <sup>3</sup>	240
Practibox	191
XL <sup>3</sup> 125	196
XL <sup>3</sup> 160	198
XL <sup>3</sup> 400	202 to 209
XL <sup>3</sup> 800	210 to 219
XL <sup>3</sup> 4000	220 to 233
Distribution terminal blocks	180
DLP	
aluminium	761 to 764
distribution columns	767 to 770
LED system mini-trunking	736, 737
mini-trunking for distribution	739 to 741
mini-trunking for installation	730 to 735
snap-on trunking	742 to 751
trunking systems	752 to 757
DMX <sup>3</sup> and DMX <sup>3</sup> -I (ACBs)	140 to 145
Domestic cartridge fuses / fuse carriers	66
Domestic pin configuration	
industrial sockets (P17 Tempra)	327
Door contact switches	580
Door entry systems Arteor	422
Kit	582 to 584
Double pole switches	
Arteor	367
Belanko	495
Galea Life	466
Mallia	501, 508
Programme Mosaic	784
Synergy	518, 519, 523, 529, 535, 540
Valena	452, 453
Vela	484
DPX <sup>3</sup> (MCCBs)	120 to 138
DPX <sup>3</sup> -I (trip free switches)	151
DPX-IS (isolating switches)	147
DRX (MCCBs)	106 to 117
Duplex cable marking system	571
DX-E [6000] - 6 kA	46
DX <sup>3</sup> -IS isolating switches	47
DX <sup>3</sup> MCBs	
add on modules	58
auxiliaries	60
DX <sup>3</sup> [6000] - 10 kA	52
DX <sup>3</sup> [10000] - 16 kA	54
DX <sup>3</sup> - 25 kA	56
DX <sup>3</sup> - 50 kA	57
DX <sup>3</sup> RCBOs	50
DX <sup>3</sup> -ID RCDs	48
DX <sup>3</sup> - manual supply invertors	61
DX <sup>3</sup> motorised controls	61

## E

Electrical blocks (Osmoz)	305
Electrical energy metering	
on door	85
on rail	84
Electromagnetic door holder	623, 627
Electromechanical siren	348
Electronic time-lag switches	77
Emergency boxes	651
Emergency lighting unit	
Arteor	367
Vela	488
Emergency lighting luminaires	604 to 620
B 65 LED	612
B 65 NEW	612
B 66	615
B 66 LED	611
batteries	617
Inox LED	611
labels	616
LVS2 (Legrand Vision System)	618
Power packs	620
S8	614
safety portable lamps	616
spare parts	616
U21 NEW	609
URA ONE	608
Emergency stop push-buttons	
Arteor	367
Plexo IP 55	551
Programme Mosaic	791
Enclosures	
Atlantic cabinets	244
Atlantic-E	248
heat regulation	262
Marina cabinets and enclosures	250 to 252
VDI	704, 705
XL <sup>3</sup> 125	196
XL <sup>3</sup> -N 125	197
XL <sup>3</sup> 160	198
XL <sup>3</sup> -N 250	197
XL <sup>3</sup> 400	202 to 209
XL <sup>3</sup> 800	210 to 219
XL <sup>3</sup> 4000	220 to 233
XL <sup>3</sup> 6300	234
Energy and load shielding management	420
Energy compensation (capacitor banks)	97 to 104
Energy distribution	706, 707
Epoxy connectors	688
Equipment (common)	
for Atlantic, Atlantic-E and Marina	258, 259
Equipment (mounting)	
for XL <sup>3</sup> 160	198
for XL <sup>3</sup> 400	202 to 209
for XL <sup>3</sup> 800	210 to 219
for XL <sup>3</sup> 4000	220 to 233
for XL <sup>3</sup> 6300	234
Equipment (VDI)	700 to 702, 713
Equipment transformers	313
Equipotential bonding connectors	573
Ethernet Hub (switch-line)	693
Euro-US standard socket outlets	
Arteor	370
Galea Life	471
Mallia	505, 512
Programme Mosaic	793
Synergy	519, 520, 525, 531, 537, 541
Vela	486
Extensions	
multi-outlet	578

## F

Ferrules (Starfix)	292
Fibre optic	684 to 691
area distribution boxes	690
cabinets	686
cables	684
connectors	688
drawers	685, 686
FTTO (full IP)	687
patch cords	691
pigtaills	688
sockets	685
units	685

Fixed capacitor banks (Alpibloc) .....	97
Fixfor .....	569
Fixing devices .....	569
Flexible conduits .....	564
Floor boxes .....	773 to 776
Floor units and back boxes .....	772
Fluorescent inspection lamp .....	579
Flush-mounting boxes .....	565
for industrial sockets .....	327
for workstations and meeting rooms .....	777, 778
Forix .....	
IP2x .....	438, 439
IP44 .....	440
workstation .....	441
Fork type supply busbars .....	179
Forms (XL <sup>3</sup> 4000) .....	236
Frames (Osmoz) .....	306
Freestanding cabinets .....	698, 712
French standard socket outlets .....	
Arteor .....	371
Niloé .....	446
Plexo IP 55 .....	548
Valena .....	458
Front plates Synergy .....	542, 543
FTTH-Fibre to the home .....	432, 433
FTTO (fibre optic full IP) .....	687
Full load switch units .....	157
Fuse carriers (DIN rail mounting) .....	158
Vela .....	488
Fused connection units .....	
Arteor .....	369
Belanko .....	497
Mallia .....	504
Synergy .....	521, 526, 532, 538, 541
Fuses .....	66, 159, 160

## G

Galea Life .....	466 to 483
access control .....	469
automatic switches .....	466
blanking plates .....	473
buzzers .....	469
cable outlets .....	473
chimes .....	469
data sockets .....	470
dimmers .....	468
IP 44 functions .....	474
key switches .....	467
pilot lights .....	473
plates selection chart .....	482, 483
pull-cord mechanisms .....	467
push-buttons .....	468
rocker plates, cover plates .....	
selection chart .....	475 to 481
roller blinds control .....	467
socket outlets .....	471, 472
surface-mounting boxes .....	474
switches .....	466
telephone sockets .....	470
television sockets .....	471
thermostats .....	469
time delay switch .....	467
time switches .....	467
German standard adaptors .....	575
German standard socket outlets .....	
Arteor .....	370
Belanko .....	497
Galea Life .....	471, 472
Mallia .....	505
Niloé .....	445
Plexo IP 55 .....	548, 549
Programme Mosaic .....	792
Valena .....	458
Vela .....	486
German-Italian standard sockets outlets .....	
Mosaic Programme .....	793
German standard plugs and extensions .....	574
Green'up Access sockets for electric vehicles .....	554
Grid .....	
modules Synergy .....	544, 545
plates and yokes Synergy .....	542, 543
Grommets .....	779

## H

Half columns .....	768
HD (High Density) rack .....	703
Heads (Osmoz) .....	
illuminated .....	303
non-illuminated .....	302
Heat regulation for cabinets and enclosures .....	262
Heating control (My Home) .....	
BUS/SCS technology .....	414
Heating control .....	
Arteor .....	414
Galea Life .....	469
Programme Mosaic .....	789
Valena .....	454
Heavy duty floor boxes .....	776
Home network .....	
classic .....	424, 425
evolutive .....	426, 427
evolutive + .....	428, 429
Hospital equipment (Programme Mosaic) .....	809 to 823
Hospital isolating transformers .....	823
Hotel equipment .....	
Arteor .....	395 to 399
Belanko .....	496
Mallia .....	513
Programme Mosaic .....	791
Valena .....	454
Hour counters .....	
on door .....	93
on rail .....	92
HRC cartridge fuses .....	159
Hypra .....	340 to 347

## I

Illuminated functions (Programme Mosaic) .....	802
Illuminated heads (Osmoz) .....	303
Illuminated signalling units .....	302
Indicators (DIN rail mounting) .....	73
Industrial cabinets (metal) .....	244 to 249
Industrial contactors (CTX <sup>3</sup> ) .....	170
Industrial plugs and sockets .....	
Hypra .....	340 to 347
Tempra .....	326 to 335
Inox <sup>LED</sup> .....	611
Inspection lamps .....	579
Internal optical termination device .....	433
Intruder alarm BUS/SCS Arteor .....	416, 417
Isolating fuse carriers .....	67
Isolating switches .....	
DPX-IS .....	147 to 149
DX <sup>3</sup> -IS .....	47
Vistop .....	146
Isolating transformers for hospitals .....	823
Israeli standard socket outlets .....	
Arteor .....	371
Vela .....	486
Italian standard socket outlets .....	
Arteor .....	371
Programme Mosaic .....	793
Vela .....	486

## J

Junction boxes .....	183
flush-mounting .....	804, 805

## K

Kaptika .....	437
Keypad switches .....	
Arteor .....	367
Galea Life .....	469
Mallia .....	506
Niloé .....	445
Programme Mosaic .....	791
Kit for fast crimping connectors .....	688

## L

Labels for emergency lighting units .....	616
Lampholder .....	80
Lamps .....	616
Latching relay .....	
pulse operated (DIN rail mounting) .....	68
single pole Arteor .....	367
LCS <sup>2</sup> Legrand Cabling System .....	660 to 713
Light sensitive switches .....	
DIN rail mounting .....	78
Plexo IP 55 .....	551
Lighting .....	
bulkheads .....	602
control (Programme Mosaic) .....	599
portable lamps .....	616
shaverlights .....	580
vandal-proof luminaires .....	603
Lighting management .....	590 to 599
BUS/KNX .....	599
BUS/SCS .....	597 to 599
Stand alone .....	592
Lighting modules for columns .....	769
Lina 12.5 plates .....	256
Lina 25 .....	
cable ducting .....	300
crosspieces and perforated plates .....	256
Linafix (Lina 25 fixing accessories) .....	300
Line taps .....	573
Linco wall-mounting cabinets .....	710
Locking accessories .....	260
Locking nuts (cable glands) .....	267, 269
Loudspeaker sockets .....	
Arteor .....	379
Programme Mosaic .....	798
Valena .....	457
LVS <sup>2</sup> (Legrand Vision System) .....	618

## M

Mallia .....	
automatic switches .....	502, 509
blanking plates .....	514
cable outlets .....	503, 510
cooker control unit .....	502, 509
data sockets .....	503, 510
dimmers .....	502, 509
downlighters .....	506, 509
DP switches .....	501, 508
fan speed controller .....	502, 509
fused connection units .....	504
loudspeaker .....	506, 513
plates .....	512 to 514
programmable switches .....	502, 509
push-buttons .....	502, 509
haver sockets .....	503, 510
socket outlets .....	504, 505, 511, 512
support frames .....	512
switches .....	500, 501, 507, 508
switches for hotels .....	506, 513
telephone sockets .....	503, 510
television sockets .....	503, 510
time delay switch .....	502, 509
Manual call points .....	649
Marina polyester cabinets .....	
and enclosures .....	250 to 252
Marking system .....	
CAB3 .....	294 to 296
Duplix .....	571
Memocab .....	297, 298
MCBs (DIN rail mounting) .....	40 to 57
Arteor .....	368
Programme Mosaic .....	794
Vela .....	488
MCCBs .....	
DPX <sup>3</sup> .....	120 to 138
DRX .....	106 to 117
Meeting room multi-outlet extensions .....	781
Memocab marking system .....	297
Metal underfloor boxes .....	772
Mobile sockets .....	
Hypra .....	340 to 347
P17 Tempra .....	326 to 335
Modular chassis for Atlantic, Atlantic-E .....	
and Marina cabinets .....	259
Modular distribution blocks .....	181

Modular fuse carriers	66
Modular mechanisms Plexo IP 55	550, 551
Monitors (CCTV)	646
Motor protection circuit breakers	164
Movement detector (for door)	586
Multifix	569
Multi-function measuring units (EMDX <sup>3</sup> )	
on door	85
on rail	84
Multimedia multi-outlet extensions	577
Multimedia network	
classic	424, 425
evolutive	426, 427
evolutive plus	428, 429
Multi-outlet adaptors	575
Multi-outlet extensions	576 to 578
Multistandard socket outlet (Arteor)	369 to 371
My Home Screen (Arteor)	421

## N

Nedbox	194
Network video recorder (NVR)	645
Non-illuminated heads (Osmoz)	302, 303
Nylobloc	572
Niloé	
automatic switches	444
cable outlets	446
data sockets	446
dimmers	444
fan control	445
plates	451
push-buttons	443
radio/ZigBee <sup>®</sup>	444
roller blind control	444
socket outlets	445
switches	443
telephone sockets	446
television sockets	447

## O

OM2, OM3, OM4 multimode cables	684
OM2, OM3, OM4 multimode patch cords	691
Optical fibre connectors	688
Optical sockets	685
OS1, OS2 singlemode cables	684
OS1, OS2 singlemode patch cords	691
Osmoz	302 to 307
Over floor trunking	771

## P

P17 Tempra	
combined units	336
industrial plugs and sockets	326
Paint touch up	245
Panel mounting sockets	
Hypra	340 to 347
P17 Tempra	326 to 335
Passage detection	592 to 599
Patch cords	669, 673, 679
Patch panels 19" VDI	668, 672, 679
Patch units	668, 672, 679, 681
PDU (Power Distribution Unit)	706, 707
Perforated plates	256
Pigtails	688
Pilot lights	
Galea Life	473
Programme Mosaic	802
Plates	
Arteor	386 to 393
Belanko	498
Galea Life	482, 483
Mallia	514, 515
Niloé	451
Programme Mosaic	806, 807
Valena	465
Vela	490, 491
Plexo	
10/16 A sockets	548, 549
20 A sockets	548, 549
boxes	558, 559
Green'up	554
IP 55	548 to 553

Plexo 66	555
Plexo <sup>3</sup> weatherproof cabinets	240
Plugs and sockets	
british standard	574
german standard	575
Hypra industrial	340 to 347
P17 Tempra industrial	326 to 335
special	574
Pop-up type flush-mounting boxes	777, 778
Portable lamps	616
Power contactors	
DIN rail mounting (CX <sup>3</sup> )	70
industrial (CTX <sup>3</sup> )	170, 171
Power distribution blocks	182
Power factor controllers (Alptec)	103
Power over Ethernet injectors	693
Power packs (conversion kits)	620
Power supplies	
DIN rail mounting	81
filtered rectified	322
Power terminal blocks (Viking 3)	290
Prisinter (Hypra)	340
Programmable time switches	74
Programme Mosaic antimicrobial range	809 to 823
Programme Mosaic, new range	784 to 808
access control	621 to 627
audio and video sockets	799, 800
boxes	803
buzzers and bells	794
colour-lighting management	787
dimmers	787
DLP sockets	742, 744, 746
emergency	791
hospital equipment	809 to 823
hotel indicator	791
illuminated signage	802
keyswitches	791
lighting management	592 to 599
MCBs	794
plates	806, 807
power sockets	792, 793
pull cord switches	784
push-buttons	785
RJ 45 sockets	795, 796
roller blind controls	790
safety	649 to 651
sensitive switches	786
supports	808
switch sensors	786
switches	784
telephone and data sockets	797
television sockets	798
temperature regulation	789
time switches	789
touch switches	786
USB sockets	793
ventilation sockets	784
wifi access points	801
workstation kits	805
Prong-type supply busbars	179
Protective conductors	245
Proximity switching	156
Pulse operated latching relays	68
Push-buttons	
Arteor	363
Belanko	494
control push-buttons (DIN rail mounting)	73
Galea Life	468
Mallia	502, 509
Niloé	443
Plexo IP 55	548 to 550
Plexo 66	555
Programme Mosaic	785
Valena	453
Vela	485

## R

Racks	
HD (High Density)	703
wall-mounting	712
Radio/Zigbee Arteor	402 to 407
Rails	261
RCBO (DX <sup>3</sup> )	50
Arteor	368
Programme Mosaic	794
Vela	488

RCDs	
DX <sup>3</sup> -ID	48
RX <sup>3</sup>	42
Synergy	532, 541
TX <sup>3</sup>	44, 46
Readers (access control)	
centralised	625 to 627
stand-alone	622, 623
Remote control	78
for MCBs (DX <sup>3</sup> )	61
Residual current relay	139
Rigid conduits	568
RJ 45 sockets	670 to 682, 795, 796
Rocker plates	(see cover plates/rocker plates)
Roller blinds control	
Arteor	368
Galea Life	467
Niloé	444
Programme Mosaic	790
Valena	454
RX <sup>3</sup> (MCBs)	40 to 43

## S

S8	614
Safety boxes	651
Safety portable lamps	616
Screwless connection terminals	572
Screw terminal strips	572
Selector switches (Osmoz)	302
Self-contained emergency lighting luminaires	604 to 620
Sensitive switches (Mosaic)	786
Sensors	592 to 599
Server freestanding cabinets	698
Shaverlights	580
Shaver sockets	
Arteor	397
Belanko	496
Mallia	503, 510
Programme Mosaic	791
Synergy	520, 527, 533, 538
Vela	488
Shelves	702
Single phase power supplies	81
Sirens	348
Smart security system	628 to 632
Snap-on trunking	
aluminium	765, 766
black edition	774, 775
grey finish	750, 751
white finish	746 to 749
Socket outlets	
Arteor	369 to 371
Belanko	497
Din rail	80
Galea Life	471, 472
Hypra industrial	341, 342
Mallia	504, 505, 511, 512
Niloé	449
P17 Tempra industrial	324, 325
Plexo 66	555
Programme Mosaic	792, 793
RJ 11/12/45 (Programme Mosaic)	795 to 797
special for trunking systems	742, 744, 746
Synergy	519, 520, 525, 531, 537, 541
Valena	458
Vela	486
Soliroc	556, 557
Sound diffusion	
Arteor BUS/SCS	418, 419
Valena	461
Sounders	650
South African socket outlets Arteor	370
SP fuse carriers	158
Spare parts (luminaires)	616
Spring-return button (Osmoz)	302, 303
Stand alone lighting management	592
Starfix crimping tools and ferrules	292
Stay-put mushroom head (Osmoz)	302, 304
Stopping plugs (cable glands)	268
Straight plugs	
Hypra	340 to 347
P17 Tempra	326 to 335
Supply busbars	171



Support	
for busbars	187
for terminal blocks	180
special (DIN rail mounting)	80
Support frames	
Arteor	384, 385
Plexo IP 55	553
Programme Mosaic	808
Vela	489
Surface-mounting boxes	
Arteor	384
Belanko	498
Galea Life	474
Plexo IP 55	552
Programme Mosaic	803
Synergy	521
Valena	460
Vela	489
Surface-mounting sockets	
Hypra	340 to 347
P17 Tempra	326 to 335
Swiss standard socket outlets Arteor	371
Switches	
Arteor	360 to 362
Belanko	494, 495
cam switches	308 to 311
control switches (DIN rail mounting)	156
Forix	439
Galea Life	466
Kaptika	436
Mallia	500, 501, 507, 508
Niloé	443
Plexo IP 55	548, 550
Plexo 66	555
Programme Mosaic	784
Synergy	517, 522, 528, 534, 540
Valena	452, 453
Vela	484
Switch-line	693
Switch sensors (Programme Mosaic)	786
Synergy	516 to 539
blanking plates	521, 527, 533, 539, 540
cable outlets	521, 527, 533, 538, 540
cooker control units	521, 527, 532, 538
cord outlets	527, 533, 539
data sockets	518, 524, 529, 535, 540
dimmers	517, 522, 528
DP switches	518, 519, 523, 529, 535, 540
Flat plate	534 to 539
fused connection unit	521, 526, 532, 538, 541
Grid system	
architraves	542
front plates	542, 543
Grid modules	544, 545
Metalclad	540, 541
Modern	522 to 527
RCD sockets	532, 541
shaver sockets	520, 527, 533, 538
socket outlets	519, 520, 525, 531, 537, 541
surface-mounting boxes	521
switches	517, 522, 528, 534, 540
telephone sockets	518, 524, 529, 535, 540
television sockets	518, 524, 529, 535, 540
Traditional	528 to 533
White	517 to 521
yokes	542
System for addressable self-contained emergency lighting	618

## T

Technical alarm detectors	587
Telephone sockets	
Arteor	374
Belanko	496
Galea Life	470
Mallia	503, 510
Niloé	446
Programme Mosaic	797
RJ 45 (VDI)	795, 796
Synergy	518, 524, 529, 535, 540
Valena	456
Vela	487
Telephone/Ethernet units	683
Television sockets	
Arteor	374
Belanko	496
Galea Life	470
Mallia	503, 510
Niloé	447

Television sockets (continued)	
Programme Mosaic	798
Synergy	518, 524, 529, 535, 540
Valena	455
Vela	487
Tempra P17 industrial sockets and combined units	326 to 335
Terminal blocks (distribution)	
power terminal blocks (Viking 3)	290
screw connection (Viking 3)	280
spring connection (Viking 3)	282
Terminal shield boxes	190
Terminal strips Nylbloc	572
Thermostats	
Arteor	368
Galea Life	469
Programme Mosaic	789
Valena	454
Time delay relays (DIN rail mounting)	79
Time switches relays (DIN rail mounting)	74
Time-lag switches (DIN rail mounting)	77
Touch switches (Programme Mosaic)	786
Transcab cable ducting	299
Transformers (DIN rail mounting)	80
control and signalling transformers	312
equipment transformers	313
Trip free switches	
DMX <sup>3</sup> -I	142
DPX <sup>3</sup> -I	151
Trunking systems	730 to 770
Tubes (and lamps)	616
Twin touch (Osmoz)	302, 303
TX <sup>3</sup> (MCBs)	44 to 46

## U

U 21 LED	609
U 21 NEW	609
U 34 LED	606
Underfloor boxes	772
Units (VDI)	668, 672, 679, 681
UPS (Uninterruptible Power Supplies)	
Daker	654 to 656
Keor multiplug	659
Niky	657
Niky S	658
URA ONE	608
USB sockets	
Arteor	372
Programme Mosaic	793
Valena	459
User cords	669, 673, 679

## V

Valena	
aluminium coverplate	465
audio/video sockets	457
automatic switches	454
blanking plates	460
cable outlets	460
data sockets	456
dimmers	454
key card	454
lamps	460
plates selection chart	465
push-buttons	453
roller blinds control	454
socket outlets	458
sound diffusion	461
surface-mounting boxes	460
switches	452, 453
telephone sockets	456
television sockets	455
thermostats	454
Vandal resistant bulkhead lights	603
VDI cabling system	660 to 713
19" patch panels	668, 672, 679
cabinets	698 to 712
Cat. 5	679, 680
Cat. 6	672 to 675
Cat. 6A	668 to 671
equipment	700 to 702, 713
equipment for weatherproof	712
PDU	706, 707
RJ45 sockets	668 to 680
switch-line	693

VDI chassis for Atlantic, Marina	259
Vela	
automatic switches	485
bells	488
blanking plates	484
buzzers	488
cord outlets	484
cover plates/rocker plates	484
data sockets	487
dimmers	485
DP switches	485
emergency light unit	488
flush-mounting boxes	489
fuse carrier	488
lamp	484
lighting units	488
MCB	488
plates selection chart	490, 491
pull-cord push buttons	486
push-buttons	485
RCBO	488
selector switches	485
shaver sockets	488
socket outlets	486
support frames	489
surface-mounting boxes	489
switches	484
telephone sockets	487
television sockets	487
Ventilators for enclosures	262
Ventilation control	
Arteor	368
Belanko	495
Programme Mosaic	784
Video door entry systems	422
Video sockets (Programme Mosaic)	799, 800
Viking 3	
power terminal blocks	290
terminal blocks	280 to 289
Vistop	146
Voltage surge protectors (DIN rail mounting)	64
Programme Mosaic	794
Voltmeters	
on door	93
on rail	92

## W

Wall mounting cabinets	704, 705
Wall mounting rack	712
Weatherproof bulkhead lights	602
White columns	768, 769
Wi-Fi access points	
Arteor	377
Programme Mosaic	692, 801
Workstation kits (Programme Mosaic)	805

## X

XL <sup>3</sup> 125	196
XL <sup>3</sup> -N 125	197
XL <sup>3</sup> 160	198
XL <sup>3</sup> -N 250	197
XL <sup>3</sup> 400	202 to 209
XL <sup>3</sup> 800	210 to 219
XL <sup>3</sup> 4000	220 to 233
XL <sup>3</sup> 6300	234

## Y

Yokes	542
-------	-----

### Conditions of sale

please consult our current price list

In accordance with its policy of continuous improvement, the Company reserves the right to change specifications and designs without notice. All illustrations, descriptions, dimensions and weights in this catalogue are for guidance and cannot be held binding on the Company.  
Printed in Poland by DONNELLEY Warszawa  
n° imp. 83930 - Copyright deposit 1<sup>st</sup> term 2014

# Catalogue number index

Cat.Nos	Page N°	Pack	Cat.Nos	Page N°	Pack	Cat.Nos	Page N°	Pack	Cat.Nos	Page N°	Pack	Cat.Nos	Page N°	Pack	Cat.Nos	Page N°	Pack
<b>0 010 00</b>			0 033 24	046	1	0 035 72	417	10/30	0 044 37	073	10/200	0 048 01	180	10/240	0 097 99	200	10/100
0 013 56	190	50	25	-	1	73	-	1/50	44	067	2/88	03	-	10/240	<b>0 100 00</b>		
57	-	30	26	-	1	75	416	3/30	53	073	10/100	05	-	10/100			
58	-	1/20	27	-	1	79	415	1/50	54	-	10/60	06	-	10/100			
89	194	1/50	28	-	1	80	-	1/50	55	-	10/60	07	-	10/100			
0 014 41	195	1	29	-	1	82	419	1	58	-	10/60	10	-	1/50			
42	-	1	30	-	1	83	418	1	63	-	10/100	11	-	5/50	0 102 02	066	10/3600
43	-	1	31	-	1	84	419	1/12	64	-	10/60	15	-	10/120	05	-	10/3600
44	-	1	32	-	1	85	418	1/28	68	-	10/60	16	-	10/120	06	-	10/3600
51	-	1	38	-	1	86	419	1	88	-	10/100	17	-	5/50	10	-	10/3600
52	-	1	70	-	1	89	-	5/200	0 046 00	092	1/12	19	-	10	20	-	10/3600
53	-	1	71	-	1	91	416	1/3	02	-	1/12	20	-	10/200	30	-	10/3600
54	-	1	72	-	1	93	395	1	10	-	2/84	22	-	10/120	50	-	10/3600
81	-	1/10	73	-	1	95	-	1/10	13	-	2/84	24	-	10/120	63	-	10/3600
82	-	1/10	74	-	1	96	-	1/10	15	-	2/84	25	-	10/120	96	-	10/3600
83	-	1/10	75	-	1	97	421	1	16	-	2/84	26	-	10/60	0 103 06 066 10/3500		
84	-	1/10	76	-	1	98	-	1	17	-	2/84	28	-	10/50			
90	-	1/12	77	-	1	0 036 52	411	1/28	18	-	2/84	30	-	10/200	0 104 24	754	12
91	-	1/50	82	-	10/100	53	-	1/28	20	-	2/84	32	-	10/120	27	755	12
0 016 60	194	20/200	84	-	10	56	-	1/50	21	-	2/84	34	-	10/120	62	754	20
62	-	10/100	85	-	10	58	078	1/30	22	-	2/84	35	-	10/100	63	756	20
65	197	10/50	86	-	10/100	59	-	1/30	24	-	2/84	36	-	10/60	64	-	16
0 019 17	240	1	87	-	10	60	-	1/12	25	-	2/84	38	-	10/50	67	755	4
18	-	1	88	-	10	65	411	1/28	31	088	1/20	40	-	10/200	70	757	8
55	-	1/8	89	-	10	66	409	1	34	-	1/20	42	-	10/120	0 105 80 747 24		
61	-	20/200	90	-	10	71	078	1/10	36	-	1/20	44	-	10/120	82	754	24
62	-	2/40	91	-	10	80	-	1/30	38	-	1/12	45	-	10/100	83	-	48
64	-	2/12	92	-	10	0 037 05	074	1/30	46	-	1/6	46	-	10/60	84	-	16
65	-	2/10	0 034 29	046	5	0 038 28	065	1/25	48	-	1/10	50	-	10/200	0 106 01 756 10/40		
66	-	1/50	31	-	5	29	-	1/25	50	092	1/20	52	-	10/120	02	754	10/40
67	-	1/10	32	-	5	41	411	1/50	52	-	1/20	54	-	10/120	05	-	10
68	-	1/50	33	-	5	42	-	1/50	53	-	1/20	57	181	1/20	06	755	5/25
69	-	1/20	34	-	5	44	-	1/50	60	-	1/12	68	-	1/48	19	754	10/50
70	-	2/20	35	-	5	0 039 10	064	1/20	63	-	1/12	71	-	4/20	21	756	10/50
71	-	5/20	36	-	5	20	-	1/24	64	-	1/12	73	-	4/20	22	754	10/50
72	-	1/20	37	-	5	21	-	1/20	66	-	2/84	76	-	1/12	35	755	5/25
73	-	1/20	38	-	5	22	-	1/20	70	084	1/10	77	-	1	38	-	5/25
0 026 01	411	1/10	39	-	5	23	-	1/15	72	-	1/24	79	-	1/12	50	-	5/25
02	-	1/10	49	-	1/12	28	-	5/20	73	-	1/18	80	-	10/100	81	757	50
11	-	1/10	50	-	1	30	-	1/24	74	-	1/18	81	-	5/50	82	-	50
12	-	1/10	51	-	1	31	-	1/20	75	-	1/9	82	-	5/50	86	764	50
22	-	1/10	52	-	1	32	-	1/20	76	-	1/9	83	-	4/20	90	760	5/25
27	-	1	53	-	1	33	-	1/15	77	-	1/24	84	-	10/50	91	754	20/200
31	-	1/6	54	-	1/12	34	-	5/20	78	-	1/24	85	-	5/30	92	-	20/400
0 030 00	064	1/15	55	-	1	39	-	5/20	79	-	1/24	86	-	5/30	95	760	100/2000
22	-	1/4	56	-	1	40	-	1/24	80	-	1/18	88	-	5/25	96	754	20/200
23	-	1/4	57	-	1	41	-	1/20	81	-	1/24	88	-	5/25	98	760	5/25
28	-	1/25	58	-	1	43	-	1/15	82	-	1/18	88	-	5/25	99	-	5/25
29	-	1/25	59	-	1	44	-	5/20	83	-	1/18	<b>0 050 00</b>			0 107 00	754	20/100
0 031 43	073	2/100	91	-	1	46	065	1/42	85	-	1/18	0 050 54	196	1/20	01	756	20/100
0 032 66	046	10	92	-	1	56	-	1/42	86	-	1/18	0 057 90	067	10/200	02	-	20/100
68	-	10	93	-	1	57	-	1/42	87	-	1/9	96	-	1/50	03	755	10/50
69	-	10	94	-	1	58	-	1/42	88	087	1/3	0 058 00	066	5/60	10	-	5/50
70	-	10	95	-	1	58	-	1/42	89	085	1/9	02	-	5/60	11	757	5/50
71	-	10	96	-	1/12	62	-	1/10	91	092	1/30	06	067	10/100	22	754	10/50
72	-	10/100	97	-	1	63	-	1/10	94	-	1/30	08	-	10/100	32	760	10
73	-	10	98	-	1	0 041 01	080	10/100	98	088	1/10	06	067	10/100	35	757	5/25
74	-	10	99	-	1	07	-	10/100	99	-	1/10	08	-	10/100	36	-	5/25
75	-	10	0 035 15	787	1	13	-	10/100	0 047 04	077	10/100	10	066	10/100	37	-	5/25
76	-	10	17	395	1	0 042 10	081	1/12	40	079	1/100	11	-	10/100	39	-	5/25
0 033 08	046	5	18	-	1	80	080	10/100	41	-	1/100	12	-	10/100	40	-	5/25
10	-	5	19	-	1	85	-	10/100	42	-	1/100	13	-	10/100	42	760	5/25
11	-	5	44	813	1	91	-	5/50	43	-	1/100	14	-	10/100	43	-	5/25
12	-	5	51	411	1/50	92	-	5/50	44	-	1/100	16	067	10/100	63	757	5/25
13	-	5	52	-	1/50	0 043 82	073	10/100	45	-	1/100	18	-	10/100	64	-	5/25
14	-	5	53	-	1/3	83	-	5/50	70	074	1/12	20	066	10/100	65	-	5/25
15	-	5	54	420	1/120	85	-	10/100	75	088	1/10	21	-	10/100	67	754	10
16	-	5	55	-	1/60	86	-	5/50	76	-	1/12	22	-	10/100	70	760	5/25
17	-	5	56	-	1/258	0 044 05	080	10/100	77	-	1/12	23	-	10/100	71	-	5/25
18	-	5	57	-	1/6	06	-	10/100	78	-	1/12	24	-	10/100	72	-	5/25
22	-	1	58	-	1/10	09	076	1/100	79	-	1/10	26	067	5/50	73	-	5/25
			59	-	1/10	16	261	10/500	80	-	1/10	28	-	5/50	80	-	5/50
			60	411	1	17	-	50/500	82	074	1/10	36	-	3/30	81	-	5/50
			62	-	1/3	33	073	10/200	91	081	1/12	38	-	3/30	82	-	5/50
			65	421	1	36	-	10/200	92	-	1/12	46	-	2/20	83	-	5/50
			66	420	1				93	-	1/12	48	-	2/20	84	756	10
			67	411	1/6												
			71	417	1/3												

**Bold pack quantities:** minimum quantities to be ordered. **Red catalogue number:** new products

Cat.Nos	Page N°	Pack	Cat.Nos	Page N°	Pack	Cat.Nos	Page N°	Pack	Cat.Nos	Page N°	Pack	Cat.Nos	Page N°	Pack	Cat.Nos	Page N°	Pack
0 107 85	756	10	0 112 47	763	2	0 141 02	159	10/500	0 153 63	159	10/250	0 190 85	736	1	0 201 28	204	1
86	754	10	48	-	2	04	-	10/500	80	-	10/250	86	737	1/18	30	200	1/20
89	755	5	50	762	5/25	06	-	10/500	96	-	10/250	87	-	1	35	208	1/15
92	757	2	51	-	5/25	08	-	10/500	97	-	10/250	88	-	1	37	-	1/30
98	755	2	52	-	5/25	10	-	10/500				90	-	6/60	38	204	1
			53	-	5/25	12	-	10/500	0 155 50	159	10/200	91	-	1/10	39	-	1
0 108 00	755	10/100	54	-	5	16	-	10/500	63	-	10/200	92	-	1	40	208	1
01	754	10/100				20	-	10/500	80	-	10/200	93	736	10/50	41	-	1/8
02	756	10/100	0 113 10	066	10/4000	25	-	10/500	96	-	10/200	94	-	5/25	42	-	1/4
						32	-	10/500	97	-	10/200	96	-	5/50	43	-	1
0 109 10	759	5/50	0 114 06	066	10/4000	40	-	10/500				97	737	10/100	44	-	1
13	-	10/50	10	-	100/4000	50	-	10/500	0 160 35	160	3/60	98	-	10/100	45	-	1
23	-	5/25							40	-	3/60	99	-	1/18	46	-	1
25	-	5	0 116 10	066	10/2000	0 143 00	159	10/600	45	-	3/60				47	-	1
27	-	10/100	16	-	10/2000	06	-	10/600	50	-	3/60	0 199 02	160	5/50	48	-	1
33	-	5/25				10	-	10/600				30	-	5/50	49	-	1
35	-	5	0 117 16	066	10/2000	16	-	10/600	0 163 18	160	10/50	31	-	5/50	50	199	1/12
52	-	20				20	-	10/600	20	-	10/50	32	-	5/25	60	200	1
54	-	20	0 120 04	159	10/2500	25	-	10/600	22	-	10/50	35	-	5/20	63	205	1
56	-	10	06	-	10/2500	32	-	10/600	25	-	10/50	36	-	5/20	64	-	1
58	-	10	08	-	10/2500	40	-	10/600	30	-	10/50	37	-	1/5	65	-	1
92	-	20	10	-	10/2500	50	-	10/600	35	-	10/50	38	-	5	66	-	1
93	-	20/20							40	-	10/50	39	-	5/20	67	-	1
94	-	20	0 123 00	159	10/2500	0 145 16	159	10/500	45	-	10/50	42	-	3/30	68	-	1
96	-	10	01	-	10/2500	20	-	10/500	50	-	10/50	43	-	1/10	69	-	1
98	-	10	02	-	10/2500	25	-	10/500	55	-	10/50	44	-	3/30	70	209	1/10
			04	-	10/2500	32	-	10/500				45	-	1/10	90	208	1
0 111 00	762	8	06	-	10/2500	40	-	10/500	0 166 35	160	3/30	46	-	3/30	93	209	10/60
01	-	8	10	-	10/2500	50	-	10/500	40	-	3/30	47	-	3/30	95	216	1/6
02	763	4	16	-	10/2500				45	-	3/30	48	-	3/15	96	208	1
03	-	4	20	066	10/2500	0 146 00	093	1/12	50	-	3/30	49	-	1/10			
04	-	4				01	-	1/12	55	-	3/30	50	-	3/15	0 202 01	206	1/10
05	-	4	0 124 02	159	10/2500	10	-	1/42				51	-	1/10	02	208	1/6
06	-	12	04	-	10/2500	13	-	1/42	0 168 35	160	3/30				03	207	1/5
07	-	12	06	-	10/2500	15	-	1/42	40	-	3/30				04	208	1/20
08	762	24	10	-	10/2500	16	-	1/42	45	-	3/30				05	203	1/2
09	-	24	16	-	100/2500	17	-	1/42	50	-	3/30				06	206	1/10
10	-	16	20	066	10/2500	18	-	1/42	55	-	3/30				07	207	1/4
11	-	16				20	-	1/42							08	206	1/2
12	763	8	0 126 16	066	10/2000	21	-	1/42	0 171 50	160	3/30	0 200 00	200	1/8	09	206	1/2
14	762	8	20	-	10/2000	22	-	1/42	55	-	3/30	02	199	1	11	-	1/2
15	-	20/100	25	-	10/2000	24	-	1/42	60	-	3/30	03	-	1	13	-	1/2
58	-	20/100				25	-	1/42	65	-	3/30	04	-	1	17	207	1/2
59	-	10/50	0 127 25	066	10/2000	26	-	1/42				05	-	1	21	-	1/4
60	763	10/50				28	-	1/42	0 173 50	160	3/30	06	198	1/6	23	-	1
61	-	10/100	0 130 01	159	10/1500	50	311	1/20	55	-	3/30	13	-	1	25	-	1/4
62	762	10/100	02	-	10/1500	52	-	1/20	60	-	3/30	14	-	1	28	-	1/4
63	-	10/100	04	-	10/1500	53	-	1/20	65	-	3/30	15	-	1	29	-	1
66	-	20/400	06	-	10/1500	60	093	1/12				16	-	1	40	208	1
67	764	10/50	08	-	10/1500	61	-	1/12	0 176 60	160	3/15	20	199	1	41	-	1/4
68	-	5/25	10	-	10/1500	66	-	1/42	65	-	3/15	21	-	1/10	42	-	1/4
69	-	5/25	12	-	10/1500	68	085	1/10	70	-	3/15	35	-	1/12	43	-	2
70	-	5/25	16	-	10/1500	69	-	1/10	75	-	3/15	45	-	1	52	200	1
88	-	20/500	20	-	10/1500	71	-	1/30				46	-	1	53	-	1
89	763	10/50	25	-	10/1500	72	-	1/30	0 178 60	160	3/15	50	200	1/20	54	-	1
90	-	5/50	95	-	10/1500	73	-	1/30	65	-	3/15	51	-	20	55	-	1
91	762	20/200				74	-	1/30	70	-	3/15	52	199	1	56	-	1
92	-	20/200	0 133 00	159	10/1500	75	-	1/30	75	-	3/15	53	-	1	57	205	1
			01	-	10/1500	77	-	1/30				54	-	1	58	-	1
			02	-	10/1500				0 190 03	736	10	55	-	1	59	-	1
0 112 02	764	20							06	-	10	56	-	1	72	200	1
03	-	20							12	-	10/100	70	200	1/10	73	-	1
04	-	20							16	-	10/100	71	199	1/10	74	-	1
06	-	10							20	-	10/100	80	209	100/2000	75	-	1
08	-	10							24	-	10/100	90	208	1/10	76	-	1
12	-	20							36	-	10/500	91	-	50/500	77	205	1
13	-	20							40	-	10/500	92	-	20/400	78	-	1
14	-	20							43	-	10/500	93	200	1/15	79	-	1
16	-	10							45	-	5/125	94	-	10/100	82	200	1
18	-	10							47	-	5/25	98	208	6	83	-	1
20	762	1							49	-	10/100				84	-	1
21	-	1							51	-	10/200	0 201 00	199	1/10	85	-	1
22	-	1	0 134 02	159	10/1500				53	-	10/200	03	204	1	86	-	1
27	763	1	04	-	10/1500				54	-	10/200	04	-	1	87	205	1
28	-	1	06	-	10/1500	0 151 25	159	10/200	55	-	10/200	05	-	1	88	-	1
29	-	1	08	-	10/1500	32	-	10/200	57	-	2/36	06	-	1	89	-	1
30	-	1	10	-	10/1500	40	-	10/200	71	-	2	07	-	1	91	200	1/24
31	762	1	16	-	10/1500	50	-	10/200	72	-	2	08	-	1	92	-	1/24
32	-	1	20	-	10/1500	63	-	10/200	73	-	1	10	205	1	93	-	1/24
33	-	1	25	-	10/1500	80	-	10/200	74	-	2/36	12	-	1	94	-	1/24
38	763	1	32	066	10/1500	95	-	10/200	75	-	2	18	204	1	96	216	1/24
39	-	1				97	-	10/200	76	-	2	19	-	1			
40	-	1	0 140 10	159	10/600				77	-	1	20	205	1/6	0 203 00	206	1/5
41	-	1	12	-	10/600	0 153 00	159	10/250	78	-	4/16	21	-	1/10	01	-	1/5
42	762	10	16	-	10/600	16	-	10/250	80	-	1/18	23	204	1	03	207	1
43	-	10	20	-	10/600	25	-	10/250	81	-	1	24	-	1	04	-	1
44	-	10	25	-	10/600	32	-	10/250	82	-	1	25	-	1	07	-	1
45	763	5	40	-	10/600	40	-	10/250	83	-	1/18	26	-	1	09	206	1
46	-	2	50	-	10/600	50	-	10/250	84	-	1	27	-	1	10	-	1

**Bold pack quantities:** minimum quantities to be ordered. **Red catalogue number:** new products

Cat.Nos	Page N°	Pack	Cat.Nos	Page N°	Pack	Cat.Nos	Page N°	Pack	Cat.Nos	Page N°	Pack	Cat.Nos	Page N°	Pack	Cat.Nos	Page N°	Pack
0 203 11	206	1	0 205 08	224	1	0 206 45	219	1	0 208 45	219	1	0 209 89	219	1	0 212 73	215	1
12	-	1	09	-	1	46	-	1	46	-	1	90	-	1	74	-	1
13	-	1/5	10	225	1/20	47	233	1	48	237	1	91	-	1	76	214	1
14	-	1/5	11	224	1	48	-	1	49	-	1	92	-	1	77	-	1
15	-	1/5	12	-	1	49	-	1	50	224	1	93	-	1	78	215	1
16	-	1/5	13	-	1	51	217	1	51	-	1	94	-	1	79	-	1
17	-	1/5	14	-	1	52	219	1	52	-	1	95	-	1	95	230	1
18	207	1	15	-	1	54	-	1	53	-	1	96	-	1			
21	-	1	16	-	1	55	217	1	54	-	1						
23	-	1	17	-	1	57	-	1	55	-	1	0 211 00	217	1	0 214 04	158	3/30
25	-	1	18	-	1	61	218	1	56	-	1	02	218	1	05	-	2/20
27	-	1	19	-	1	63	229	1	57	-	1	03	227	1	0 215 04	158	1/10
28	-	1	20	-	1	69	-	1	58	-	1	04	231	1	05	-	1/10
29	-	1	21	-	1	70	218	1	59	-	1	05	-	1			
40	208	1	22	-	1	71	229	1/5	61	225	1	06	227	1	0 216 04	158	1/10
41	-	1	23	-	1	72	218	1	62	-	1	10	218	1	05	-	1/10
42	-	1/5	29	233	1	73	229	1/5	63	-	1	11	-	1			
43	-	1/5	30	224	2	76	230	1	64	-	1	12	-	1	0 221 71	156	1/20
44	-	1	31	187	1	78	213	1/2	65	-	1	13	217	1	72	-	1/20
60	200	1	32	-	1	79	-	1	66	224	1	14	231	1	73	-	1/20
89	208	1	36	237	1	80	223	1	67	-	1	15	-	1	74	-	1/4
91	200	1	37	-	1	81	229	1/5	68	237	1	16	-	1	75	-	1/4
99	-	10/400	38	-	1	83	-	1/5	69	-	1	20	153	1	76	-	1/4
			39	-	1	86	231	1	70	-	1	21	-	1	77	-	1/4
0 204 01	212	1	40	233	1	87	-	1	71	-	1	22	-	1	79	-	1/20
02	-	1	41	224	1	90	233	1	72	-	1	23	-	1	81	-	1/20
03	213	1	42	-	1				73	-	1	24	-	1	82	-	1/20
04	-	1	43	-	1	0 207 20	230	1	74	-	1	25	-	1	83	-	1/20
06	212	1	44	232	1	21	-	1	75	-	1	27	-	1	84	-	1/4
07	-	1	45	-	1	22	-	1	76	-	1	28	-	1	85	-	1/4
08	213	1	46	-	1/20	23	-	1	77	-	1/5	29	-	1	86	-	1/4
09	-	1	47	224	1	35	231	1	78	-	1/5	30	234	1	87	-	1/4
10	216	1	48	-	1	36	-	1	79	-	1/5	31	-	1	88	-	1/20
11	-	1	51	187	1	49	229	1/5	86	-	1	32	-	1	89	-	1/20
12	-	1	52	-	1	50	224	1/5	87	-	1	33	-	1			
20	-	1	53	-	1	51	232	1	88	-	1	34	-	1	0 222 82	156	5/100
23	213	1	54	225	1	52	-	1	89	-	1	35	-	1			
24	-	1	57	-	1	53	-	1	91	-	1/2	36	-	1	0 224 98	146	1/20
26	212	1	58	224	1	54	-	1	92	-	1/4	37	-	1			
27	-	1	59	-	1	59	229	1/5	93	-	1	38	-	1	0 225 00	146	1/20
28	213	1	61	-	1	61	-	1	94	-	1	39	-	1	02	-	1/10
29	-	1	62	-	1	64	-	1/5	95	-	1	40	-	1	03	-	1/20
33	-	1	63	-	1	69	-	1/5	96	-	1/4	41	-	1	05	-	1/20
34	-	1	64	225	1	70	230	1	97	-	2	42	-	1	07	-	1/20
35	216	1/15	67	-	1	72	-	1	99	-	1	44	-	1	12	-	1/10
36	-	1	68	224	1	85	-	1/5				45	-	1	15	-	1/10
37	-	1/15	69	-	1	86	-	1/5	0 209 00	217	1/10	46	-	1	16	-	1/10
41	211	1	70	219	1/10	87	-	1	01	-	1/10	47	-	1	18	-	1/10
42	-	1	71	225	1	88	-	1	05	218	1	48	-	2	20	-	1/10
43	213	1	74	-	1	90	229	1	06	217	1	49	-	1	22	-	1/10
44	-	1	77	-	1	91	-	1	07	-	1				25	-	1/10
46	212	1	79	224	1	93	230	1	10	-	1	0 212 04	230	1	27	-	1/10
47	-	1	82	225	1/5	94	229	1	13	218	1/10	08	229	1	34	-	1/10
48	213	1	84	-	1	95	-	1	17	-	1/10	09	221	1	39	-	1/10
49	-	1	85	214	1/6	96	-	1	18	227	1	11	229	1	44	-	1/10
51	214	1	86	225	1/15	97	-	1	19	-	1	13	-	1/10	46	-	1/10
52	-	1	87	-	1	98	230	1	20	218	1	17	230	1	51	-	1/10
53	215	1	88	-	1/8				21	228	1	18	-	1	53	-	1/10
54	-	1	89	-	1/6	0 208 00	217	1/5	22	218	1	19	-	1	54	-	1/10
56	214	1	92	237	1	01	-	1/5	23	-	1	20	-	1	56	-	1/10
57	-	1	96	-	1/4	02	237	1	27	-	1	21	-	1			
58	215	1	97	-	1/6	03	-	1	34	-	1	23	-	1	0 226 05	157	1/6
59	-	1	98	-	1/6	05	218	1	35	231	1	24	-	1	07	-	1/6
60	216	1	99	-	1/4	06	217	1	36	-	1	34	231	1	15	-	1
61	-	1				07	-	1	38	232	1	35	-	1	17	-	1
62	-	1	0 206 01	217	1/5	08	237	1	39	-	1	37	-	1	25	-	1
66	214	1	02	219	1/6	09	-	1	40	219	1	45	232	1	27	-	1
67	-	1	04	-	1	10	217	1	41	-	1	47	-	1	33	-	1
68	215	1	05	217	1	13	218	1/5	42	-	1/10	48	-	1	34	-	1
69	-	1	07	-	1	17	-	1/5	43	-	1/10	51	212	1	35	-	1
70	219	1	08	218	1	18	237	1	44	-	1	52	-	1	37	-	1
73	215	1	11	-	1	19	-	1	45	-	1	53	213	1			
74	-	1	13	-	1	20	218	1	46	-	1	54	-	1	0 227 00	156	1/50
82	214	8/40	15	-	1	22	-	1	48	232	1	56	212	1	04	146	1/100
83	215	1	17	-	1	23	-	1	49	219	1/10	57	-	1	07	-	1/100
84	-	1	18	227	1	27	237	1	50	217	1	58	213	1	32	-	1/10
86	214	1/20	19	-	1	28	-	1	51	-	1	59	-	1	97	061	1/50
90	216	1	20	218	1	29	-	1	57	-	1	61	212	1			
91	-	1	22	-	1	34	218	1	59	219	1/40	62	-	1	0 229 01	305	20/800
			23	-	1	36	227	1	60	217	1	63	213	1	02	-	20/800
0 205 00	224	1	27	217	1	37	237	1	62	-	1	64	-	1	03	-	10/400
01	-	1	28	213	1/2	38	-	1	65	229	1	66	212	1	10	-	5/250
02	-	1	29	-	1	39	-	1	70	218	1	67	-	1	11	-	5/250
03	-	1	40	233	1/2	40	219	1	72	-	1	68	213	1	12	-	5/250
04	-	1	41	219	1	41	-	1	76	230	1	69	-	1	13	-	5/250
05	-	1	42	-	1	42	-	1/5	84	218	1	71	214	1	14	-	5/250
06	-	1	43	-	1	43	-	1/5	86	231	1	72	-	1	20	-	1/100
07	-	1	44	-	1	44	-	1	87	-	1						

**Bold pack quantities:** minimum quantities to be ordered. **Red catalogue number:** new products

Cat.Nos	Page N°	Pack	Cat.Nos	Page N°	Pack	Cat.Nos	Page N°	Pack	Cat.Nos	Page N°	Pack	Cat.Nos	Page N°	Pack	Cat.Nos	Page N°	Pack
0 229 21	305	1/100	0 239 23	302	10/100	0 241 88	306	1/100	0 261 70	149	1/5	0 266 02	147	1	0 270 22	106	1/12
22	-	1/100	24	-	1/100	90	-	5/250	71	-	1/5	03	-	1	23	-	1/12
23	-	1/40	26	-	1/100	91	-	5/250	72	-	1/5	06	-	1	24	-	1/12
24	-	1/40	27	-	1/100	92	-	5/250	73	-	1/5	07	-	1	25	-	1/12
40	-	5/250	28	-	5/200	93	-	5/250	74	-	1/5	12	-	1	27	-	1/12
41	-	5/250	29	-	1/40	96	-	1/100	75	-	1/5	13	-	1	28	-	1/12
42	-	5/250	30	303	10/100				76	-	1/5	16	-	1	29	-	1
43	-	5/250	31	-	1/40	0 242 00	306	1/40	78	085	1	17	-	1	30	-	1/9
44	-	5/250	32	-	1/40	01	-	1/40	79	-	1	22	-	1	31	-	1/9
60	-	20/800	34	-	1/40	02	-	1/10	80	149	1/8	23	-	1	32	-	1/9
61	-	10/120	40	-	5/200	03	-	1/10	81	-	1/8	26	-	1	33	-	1/9
62	-	10/120	43	-	1/100	04	-	1/10	82	-	1/8	27	-	1	34	-	1/9
64	-	20/800	50	-	1/100	05	-	1/10	83	-	1/8	30	-	1	35	-	1/9
65	-	5/200	51	-	1/100	41	-	10/500	84	-	1/5	31	-	1	37	-	1/9
66	-	5/200	52	-	1/100	42	-	10/500	85	-	1/5	32	-	1	38	-	1/9
68	-	10/400	53	-	1/40	50	-	1/100	86	-	1/8	33	-	1	39	-	1
71	-	1/100	54	-	1/100	51	-	1/100	88	085	1/12	34	-	1	40	-	1/12
72	-	1/100	60	-	1/100	52	-	1/100	89	-	1/12	35	-	1	41	-	1/12
73	-	10/120	61	-	1/100	53	-	1/40	90	149	1/4	36	-	1	42	-	1/12
74	-	10/120	63	-	1/100	54	-	1/100	91	-	1/4	37	-	1	43	-	1/12
76	-	10/120	80	302	5/200	70	-	1/100	93	138	1	40	-	1	44	-	1/12
77	-	1/50	82	-	5/200	71	-	1/100	94	-	1	41	-	1	45	-	1/12
78	-	1/50				72	-	1/100				42	-	1	46	-	1/12
80	-	1/50	0 240 00	303	10/400	73	-	1/100	0 262 24	133	1/8	43	-	1	47	-	1/12
81	-	1/50	01	-	10/400	74	-	1/100	30	114	1/4	44	-	1	48	-	1/12
82	-	1/50	02	-	10/400				39	147	1/6	45	-	1	50	-	1/8
90	-	1/50	03	-	1/40	0 243 02	306	10/1000	40	114	1/5	46	-	1	51	-	1/8
91	-	1/50	04	-	5/250	03	-	10/1000	41	133	1	47	-	1	52	-	1/8
92	-	1/50	11	-	1/100	07	-	10/400	44	114	1	50	-	1	53	-	1/8
			12	-	1/100	08	-	10/1000	45	-	1	51	-	1	54	-	1/8
0 230 00	305	5/200	31	304	1/100	15	-	10/1000	46	133	1/6	52	-	1	55	-	1/6
01	-	5/200	32	-	5/200	16	-	10/1000	47	114	1/3	53	-	1	56	-	1/8
02	-	5/200	33	-	1/100	18	-	10/1000	48	-	1/5	54	-	1	57	-	1/6
03	-	1/50	35	-	1/40	19	-	10/400	49	-	1/6	55	-	1	58	-	1/8
04	-	1/50	36	-	1/40	30	-	10/1000	50	-	1/5	56	-	1	60	-	1/12
05	-	1/50	37	-	1/40	32	-	10/400	51	-	1/3	57	-	1	61	-	1/12
06	-	5/200	41	-	1/40	43	-	10/400	60	137	1/4	60	148	1	62	-	1/12
07	-	5/200	42	-	5/40	44	-	10/400	61	-	1	61	-	1	63	-	1/12
08	-	5/200	43	-	5/40	51	-	10/1000	64	-	1	62	-	1	64	-	1/12
10	-	5/200	51	-	1/40				65	-	1	63	-	1	65	-	1/12
11	-	5/200	52	-	1/100	0 248 45	306	1/12	66	-	1/3	64	-	1	67	-	1/12
12	-	5/200	53	-	1/100				67	-	1/5	65	-	1	68	-	1/12
13	-	1/100	54	-	1/100				68	-	1/3	66	-	1	70	-	1/9
14	-	1/50	55	-	1/100				69	-	1/5	67	-	1	71	-	1/9
15	-	1/100	56	-	1/100				70	-	1/6	68	-	1	72	-	1/9
16	-	5/200	57	-	1/100				73	-	1	69	-	1	73	-	1/9
17	-	5/200	58	-	1/40				74	-	1	70	-	1	74	-	1/9
18	-	5/200	59	-	1/40				81	133	1/3	71	-	1	75	-	1/9
			60	-	1/40				82	-	1/3	72	-	1	77	-	1/9
0 238 00	302	10/400	61	-	1/40	0 253 45	132	1	83	137	1/3	73	-	1	78	-	1/9
01	-	10/400	73	303	5/200	0 254 15	132	1	84	-	1	74	-	1			
02	-	10/400	80	304	1/15	0 260 60	132	1	87	147	1/6	75	-	1	0 271 00	110	1/9
03	-	10/400	82	-	5/50	61	-	1	88	-	1/5	76	-	1	01	-	1/9
04	-	10/400	91	-	1/50	63	-	1	93	133	1/6	77	-	1	02	-	1/9
06	-	10/400				64	-	1	94	-	1/6	78	-	1	03	-	1/9
08	-	1/40	0 241 00	304	10/100	65	-	1	88	139	1/24	79	-	1	04	-	1/9
09	-	1/100	01	-	10/100	67	-	1	92	-	1/12	80	-	1	05	-	1/9
11	-	5/250	02	-	10/100	92	-	1/12	93	-	1/10	81	-	1	06	-	1/6
12	-	5/250	03	-	1/100	94	-	1	94	-	1	82	-	1	07	-	1/6
13	-	5/250	04	-	10/100	95	-	1	95	-	1	83	-	1	08	-	1/6
21	-	5/250	05	-	10/100	96	-	1	96	-	1	86	147	1/5	09	-	1/6
22	-	1/100	20	-	10/100	97	-	1	81	-	1	87	-	1/3	10	-	1/6
26	-	5/250	21	-	10/100	98	-	1	82	-	1	89	-	1/8	11	-	1/6
34	-	10/100	22	-	10/100				83	-	1	90	-	1/8	12	-	1/9
35	-	10/100	23	-	1/100	0 261 19	137	1				92	-	1	13	-	1/9
36	-	10/100	24	-	10/100	23	-	1	0 263 50	114	1/4	94	-	1	14	-	1/9
37	-	1/15	30	-	1/40	24	-	1	51	-	1/4	97	148	1/12	15	-	1/9
72	-	10/100	31	-	1/100	25	-	1	52	-	1/4				16	-	1/9
74	-	10/100	32	-	1/100	26	-	1	53	-	1				17	-	1/9
76	-	1/15	33	-	1/40	27	-	1	58	-	1				18	-	1/6
80	-	10/100	34	-	1/40	28	-	1	80	137	1				19	-	1/6
81	-	1/40	40	-	10/100	29	-	1	81	-	1				20	-	1/6
82	-	10/100	41	-	10/100	36	087	1/2	82	-	1				21	-	1/6
83	-	1/15	42	-	10/100	37	-	1/3	83	-	1				22	-	1/6
85	-	10/100	43	-	1/100	40	133	1/2	76	-	1/12				23	-	1/6
91	-	10/100	44	-	10/100	41	-	1/2	78	-	1/5				24	-	1/9
92	-	1/50	60	-	10/400	44	-	1/2	79	137	1/5				25	-	1/9
94	-	1/50	61	-	10/400	45	087	1/4	80	-	1/5				26	-	1/9
95	-	5/50	62	-	10/400	54	137	1	89	149	1/3				27	-	1/9
			63	-	5/250	56	138	1	90	-	1/3				28	-	1/9
0 239 01	302	1/40	64	-	5/250	58	133	1/5	91	-	1				29	-	1/9
02	-	1/40	71	306	10/1000	59	-	1/5	92	-	1				30	-	1/6
03	-	10/100	73	-	1/50	60	149	1/5	93	-	1				31	-	1/6
04	-	1/40	76	-	10/400	64	-	1/5	94	-	1				32	-	1/6
09	-	1/40	79	-	10/400	65	-	1/5	95	-	1				33	-	1/6
15	-	10/100	81	-	1/50	66	-	1/5	96	-	1				34	-	1/6
21	-	1/40	85	-	1/12	67	-	1/5	97	-	1				35	-	1/6
22	-	1/40	87	-	10/400	68	-	1/5	98	-	1				40	-	1/24

**0 250 00**

Cat.Nos	Page N°	Pack	Cat.Nos	Page N°	Pack	Cat.Nos	Page N°	Pack	Cat.Nos	Page N°	Pack	Cat.Nos	Page N°	Pack	Cat.Nos	Page N°	Pack
0 271 41	110	1/24	0 277 16	308	1/20	0 286 66	140	1	0 288 03	141	1	0289 53	141	1	0 309 49	735	12
42	-	1/24	17	-	1/20	67	-	1	04	-	1	60	-	1	0 310 65	769	1/10
50	-	1/24	18	-	1/20	68	-	1	05	-	1	61	-	1	66	-	1/10
51	-	1/24	21	-	1/20	71	-	1	06	-	1/3	62	-	1	67	-	1/10
52	-	1/24	22	-	1/20	72	-	1	10	-	1	63	-	1	69	743	5/25
53	-	1/24	23	-	1/20	73	-	1	11	-	1	70	142	1	0 312 02	732	20/1000
54	-	1/24	25	-	1/20	74	-	1	12	-	1/4	71	-	1	03	-	20/400
55	-	1/24	26	-	1/20	75	-	1	13	143	1/4	77	-	1	07	730	10/500
60	-	1	27	-	1/20	76	-	1	14	-	1/5	78	-	1	10	558	20/200
61	-	1/24	28	-	1/12	77	-	1	15	-	1/8				11	733	10/200
62	-	1	31	-	1/20	78	-	1	16	-	1/5	<b>0 300 00</b>			0 313 01	437	250
63	-	1/24	32	-	1/20	83	142	1	20	-	1/8	0 300 07	732	120	50	760	10
64	-	1/24	33	-	1/12	84	-	1	21	-	1/4	08	-	120	51	-	5
65	-	1/24	36	-	1/20	85	-	1	23	-	1/8	11	771	10/50	52	-	5
66	-	1/24	37	-	1/20	86	-	1	24	-	1/5	12	-	10/100	80	568	100/600
67	-	1	38	-	1/12	87	-	1	25	-	1/6	14	732	80	81	-	100/600
68	-	1	41	-	1/20	88	-	1	26	-	1/5	15	-	80	82	-	50/300
70	106	1/16	42	-	1/12	93	-	1	28	-	1/6	18	771	5/50	83	-	200/1200
71	-	1/16	43	-	1/12	94	-	1	29	-	1/10	19	-	10/150	0 314 04	732	10/50
72	-	1/24	46	-	1/4	95	-	1	30	-	1/15	27	733	48	08	733	10/50
73	-	1/24	47	-	1/4	96	-	1	31	-	1/15	33	734	20	14	732	5/25
74	110	1/5	48	-	1/4	97	-	1	32	-	1/8	92	771	54	18	733	5/25
75	-	1/5	51	-	1/4	98	-	1	33	-	1/8	93	-	36	56	-	10/50
76	106	1/5	52	-	1/4	0 287 21	140	1	34	-	1	98	738	132	66	-	5/25
77	-	1	53	-	1/4	22	-	1	35	-	1	99	-	90	0 315 24	569	2000/8000
78	110	1/5	55	-	1/20	23	-	1	36	-	1	0 301 14	734	32	25	-	1000/5000
79	-	1	56	-	1/12	22	-	1	37	-	1	0 302 08	733	10/100	26	-	1000/5000
80	106	1/8	58	-	1/12	24	-	1	38	-	1/5	09	734	10/100	27	-	1000/5000
81	-	1/8	60	-	1/12	25	-	1	40	-	1	16	735	10/50	28	-	1000/5000
82	-	1/8	62	-	1/12	26	-	1	41	-	1/5	18	734	10/100	29	-	100/5000
83	-	1/5	64	-	1/4	27	-	1	42	-	1/5	21	732	10/100	30	-	100/2500
84	-	1/5	66	-	1/4	28	-	1	43	-	1/5	23	-	10/100	31	-	100/2000
85	110	1/6	67	-	1/12	31	-	1	44	-	1/5	24	-	10/200	32	-	100/2000
86	-	1/6	68	-	1/20	32	-	1	45	-	1/5	26	735	10/50	33	-	80/1600
87	106	6	69	-	1/20	33	-	1	48	-	1/5	51	732	10/100	34	-	60/1200
88	110	5	70	-	1/20	34	-	1	49	-	1/5	53	-	10/100	35	-	40/800
89	106	20	71	-	1/12	35	-	1	50	-	1/5	54	-	10/200	36	-	20/400
90	-	12	72	-	1/12	36	-	1	51	-	1/5	81	733	10/100	54	-	2000/8000
91	-	1/12	73	-	1/12	37	-	1	52	-	1/5	83	-	10/50	55	-	1000/5000
92	-	1/4	75	-	1/20	38	-	1	55	-	1/5	90	734	10/200	56	-	1000/5000
93	-	1/4	76	-	1/12	41	-	1	56	-	1/5	91	-	10/100	57	-	1000/5000
94	110	1/4	77	-	1/12	42	-	1	57	-	1/5	92	-	10/100	58	-	1000/5000
0 272 20	106	1	78	-	1/20	43	-	1	58	-	1/5	93	-	10/50	59	-	100/5000
21	-	1	79	-	1/12	44	-	1	59	-	1/5	0 303 00	734	10/100	77	-	1000/5000
22	-	1	80	-	1/12	45	-	1	62	-	1/5	01	-	10/100	78	-	100/2500
23	-	1	81	-	1/12	46	-	1	63	-	1/5	02	-	10/50	79	-	100/2000
24	-	1	82	-	1/12	47	-	1	64	144	1	03	-	10/50	81	-	30/600
25	-	1	83	-	1/12	48	-	1	65	-	1	16	735	10/100	0 316 11	735	10/40
26	-	1	84	-	1/4	51	-	1	66	-	1	26	-	10/50	13	-	5/25
27	-	1	85	-	1/4	52	-	1	69	143	1	36	-	10	14	-	5/20
28	110	1	0 286 21	140	1	53	-	1	79	143	1	0 304 18	735	10/50	21	-	10
29	-	1	22	-	1	54	-	1	82	144	1/2	40	732	10/100	22	-	10
30	-	1	23	-	1	55	-	1	83	-	1/2	0 306 54	735	10/40	40	732	10/100
31	-	1	24	-	1	56	-	1	84	-	1/2	67	-	135	41	-	10/100
32	-	1	25	-	1	57	-	1	85	-	1/2	98	-	1/5	45	734	10/100
33	-	1	26	-	1	58	-	1	86	-	1	0 307 00	769	1	47	733	10/100
34	114	1	27	-	1	61	-	1	87	-	1	03	768	1	48	734	10/100
35	-	1	28	-	1	62	-	1	88	-	1	07	-	1	94	735	5/25
36	-	1	31	-	1	63	-	1	89	-	1	08	-	1	95	-	5
37	-	1	32	-	1	64	-	1	90	-	1	09	-	1	96	-	5
38	-	1	33	-	1	65	-	1	91	-	1	27	-	1	0 317 01	732	10/50
39	-	1	34	-	1	66	-	1	92	-	1	28	-	1	02	-	10/50
40	-	1	35	-	1	67	-	1	93	-	1	29	769	1	03	-	5/25
41	-	1	36	-	1	68	-	1	94	-	1	42	-	1	04	733	10/50
42	-	1	37	-	1	71	-	1	95	-	1	78	-	1/10	05	-	5/25
43	-	1	38	-	1	72	-	1	96	-	1/2	79	-	1/10	06	-	5/25
44	-	1	41	-	1	73	-	1	97	-	1/2	80	-	1/10	07	-	10/50
45	-	1	42	-	1	74	-	1	0 289 02	143	1	81	-	1/10	08	-	5/25
46	-	1	43	-	1	75	-	1	03	-	1	82	-	1/10	09	-	5/25
47	-	1	44	-	1	76	-	1	04	-	1	83	-	1/10	27	-	1
48	-	1	45	-	1	77	-	1	05	-	1	84	-	1/10	28	-	1
49	-	1	46	-	1	78	-	1	09	-	1	85	-	1/10	29	769	1
50	-	1	47	-	1	83	142	1	10	-	1	86	-	1/10	42	-	1
51	-	1	48	-	1	84	-	1	11	-	1	87	-	1/10	78	-	1/10
52	106	1	49	-	1	85	-	1	12	-	1	88	-	1/10	79	-	1/10
53	-	1	50	-	1	86	-	1	13	-	1	89	-	1/10	80	-	1/10
54	-	1	51	-	1	87	-	1	14	-	1	90	-	1	94	-	1
0 273 22	147	1/6	52	-	1	88	-	1	15	-	1	91	-	1	95	-	1
0 275 34	311	1/20	53	-	1	93	-	1	16	-	1	92	-	1	96	-	1
35	-	1/20	54	-	1	94	-	1	20	144	1	97	-	1	97	-	1
0 277 10	308	1/12	55	-	1	95	-	1	21	-	1	98	-	1	98	-	1
11	-	1/12	56	-	1	96	-	1	22	-	1	99	-	1	0 308 04	733	60
12	-	1/12	57	-	1	97	-	1	23	-	1	81	757	100/1000	81	757	100/1000
13	-	1/12	58	-	1	98	-	1	24	-	1	97	735	200/4000	97	735	200/4000
			59	-	1	0 288 00	141	1	25	-	1	98	-	100/5000	98	-	100/5000
			60	-	1	01	-	1	26	-	1	99	-	100/1000	99	-	100/1000
			61	-	1	02	-	1	27	-	1				08	-	100/3000

**Bold pack quantities:** minimum quantities to be ordered. **Red catalogue number:** new products

Cat.Nos	Page N°	Pack	Cat.Nos	Page N°	Pack	Cat.Nos	Page N°	Pack	Cat.Nos	Page N°	Pack	Cat.Nos	Page N°	Pack	Cat.Nos	Page N°	Pack
0 318 09	272	100/2500	0 320 67	273	100/2000	0 326 68	684	1000	0 331 80	670	10/240	0 335 84	668	1/3	0 349 50	252	1
10	-	100/1200	68	-	50/500	70	688	10/300	81	675	10/240	85	-	1/6	59	-	1
11	-	100/1000	70	-	1000/10000	71	-	1/30	84	713	10/200	86	-	1/6	<b>0 350 00</b>		
12	-	100/500	72	-	100/2000	72	685	1/50	85	-	10/200	88	679	1/10			
13	-	100/5000	76	-	1000/10000	80	687	1/5	86	-	10/200	89	672	1/10			
14	-	100/1500	85	-	100/5000	81	-	1	87	-	10/200	90	668	1/3			
15	-	100/1000	88	-	1/10	82	-	1	88	-	10/200	91	-	10/100			
16	-	100/1000	0 325 04	684	2000	83	-	1/12	89	-	10/200	92	705	1/10			
17	-	100/500	05	-	2000	84	-	1/12	94	-	50/500	93	686	1/10			
18	-	500	06	-	2000	90	688	1	95	-	50/500	94	-	10			
20	-	100/8000	07	-	2000	91	-	1	96	-	50/500	96	696	1/3			
21	-	100/4000	08	-	2000	0 327 37	682	1/20	0 332 37	706	1/4	97	-	1/3			
22	-	100/4000	09	-	2000	44	688	1/10	38	-	1/4	98	-	1/3			
23	-	100/4000	10	-	2000	45	682	10/100	60	683	1/77	99	-	1/3			
24	-	100/4000	11	-	2000	46	-	10/100	61	-	5/330	0 336 02	732	20/200			
25	-	100/4000	12	-	2000	47	-	10/100	62	-	1/20	03	-	20/200			
26	-	100/3000	13	-	2000	48	-	10/100	78	706	1/8	04	733	20/200			
27	-	100/4000	14	-	2000	50	679	305	79	-	1/8	06	-	20/400			
28	-	100/3000	15	-	2000	51	-	305	80	693	1/5	08	730	20/200			
29	-	100/2500	20	685	1/5	52	-	305	87	706	1/8	09	-	20/200			
30	-	100/1200	22	-	1/5	53	-	305	88	-	1/8	0 340 00	573	10/100			
31	-	100/1000	50	684	2000	54	673	305	0 333 17	735	10/50	01	-	10/60			
32	-	100/500	51	-	2000	55	-	305	25	733	10/100	02	-	10/60			
33	-	100/5000	52	-	2000	56	-	500	27	-	10/100	03	-	10/40			
34	-	100/1500	53	-	2000	57	-	500	29	735	10/50	04	-	10/40			
35	-	100/1000	55	-	2000	58	-	500	30	733	10/200	33	-	20/200			
36	-	100/1000	69	686	1	59	-	500	0 334 70	681	5	34	-	10/100			
37	-	100/500	70	-	3/30	60	683	1/50	71	-	2	42	-	20/400			
38	-	500	71	-	3/30	73	679	500	72	-	2	43	-	20/200			
0 319 00	568	100/1000	72	-	3/30	74	-	500	73	-	2	44	-	10/100			
02	-	100/1000	73	-	3/30	76	673	500	74	-	2	45	-	10/60			
03	-	100/1000	74	-	3/30	77	669	500	75	-	2	0 342 11	572	10/500			
04	-	100/1000	75	-	3/30	78	-	500	0 335 01	682	1/10	13	-	10/250			
06	-	100/1000	76	-	3/30	80	457	1/3	02	-	1/8	15	-	10/200			
10	570	100/1000	77	-	3/30	81	-	1/3	05	-	1/8	17	-	10/100			
13	-	100/1000	78	-	3/30	83	682	10/100	06	-	1/5	19	-	10/50			
16	-	100/1000	79	-	3/30	86	685	1/10	07	-	1/5	21	-	10/500			
19	-	100/1000	0 326 00	691	3/30	87	669	500	09	685	1	23	-	10/250			
20	-	100/500	01	-	3/30	89	429	100	10	-	1	25	-	10/200			
21	-	100	02	-	3/30	0 328 00	771	20	11	-	1/5	27	-	10/100			
22	-	100/1000	03	-	3/30	02	-	5/50	12	681	1/10	0 343 22	572	100/1000			
25	-	100/1000	04	-	3/30	03	-	10/50	13	-	1/10	23	-	100/1000			
28	-	100/1000	05	-	3/30	05	734	1/10	16	-	1/10	25	-	100/1000			
29	-	100/2000	06	-	3/30	07	771	10/50	17	-	1/10	28	-	50/500			
30	-	100/2000	07	-	3/30	50	679	500	18	-	1/10	38	-	1000/10000			
32	-	100/2000	08	-	3/30	53	-	500	19	-	1/10	44	-	100/1000			
50	-	100/3000	09	-	3/30	55	-	500	20	690	1/10	51	-	100/2000			
55	-	100/1000	10	-	3/30	56	673	305	21	692	1/10	57	-	100/2000			
57	-	100/3000	11	-	3/30	57	-	305	22	-	1/10	85	573	20/240			
58	-	100/1000	12	-	3/30	59	-	500	24	-	1/10	86	-	10/120			
96	-	1/10	13	-	3/30	61	-	500	30	683	1/3	87	-	10/120			
0 320 12	272	1000/10000	14	-	3/30	63	-	500	31	-	1/3	98	572	10/500			
13	-	1000/10000	15	-	3/30	78	669	500	32	-	2/40	99	-	5/50			
14	-	1000/6000	16	-	3/30	88	683	500	33	-	2/40	0 344 18	252	1			
15	-	1000/4000	17	-	3/30	91	-	500	34	660	1/10	0 346 08	252	1			
18	-	1000/4000	18	433	3/30	0 329 07	685	1/10	35	681	1/10	09	-	1			
19	-	100/2000	19	-	4/40	46	245	1/5	36	-	1/10	0 347 45	253	100/2500			
20	-	100/2000	20	688	6/60	47	-	1/2	37	-	1/10	46	261	100/2400			
22	-	1000/4000	21	-	6/60	0 330 44	183	1	38	-	1/10	47	-	100/2400			
23	-	100/2000	22	-	6/60	48	688	1/10	39	-	1/10	50	253	200/2000			
24	-	100/2000	23	-	6/60	49	-	1/10	40	676	1/10	95	245	20/440			
25	-	100/1000	24	-	1/5	54	183	1	43	687	1/10	96	-	20/200			
26	-	100/1000	25	-	1/5	61	691	3/30	44	676	1/10	97	-	10/100			
27	-	100/500	26	-	1/5	63	-	3/30	45	-	1/10	0 348 04	263	1/20			
28	-	50/500	27	-	1/5	65	-	3/30	46	-	1/10	05	-	1/7			
29	-	100/2000	28	691	3/90	69	-	3/30	49	-	1/10	06	264	1/6			
30	-	1000/10000	29	-	3/90	71	-	3/30	51	679	1/3	07	263	1			
31	-	1000/10000	30	-	3/90	72	-	3/30	52	-	1/3	08	-	1			
32	-	1000/6000	31	-	3/90	73	-	3/30	54	-	2/24	16	-	1/7			
37	-	1000/4000	32	-	3/90	74	183	1	55	-	2/24	17	262	1/10			
38	-	1000/4000	33	-	3/90	75	691	3/30	61	672	1/3	34	263	1/30			
39	-	100/2000	34	-	3/90	76	-	3/30	62	-	1/3	35	-	1/18			
40	-	100/2000	35	-	3/90	80	-	3/30	63	-	1/3	36	-	1/10			
42	-	1000/4000	36	-	3/90	81	-	3/30	64	-	2/24	47	264	1/25			
43	-	100/2000	37	-	3/90	82	-	3/30	65	-	2/24	48	701	1/25			
44	-	100/2000	38	688	10/100	84	183	1	66	-	2/24	50	262	1/10			
45	-	100/1000	52	688	10/100	0 331 00	688	10/200	68	-	1/10	51	-	1/4			
46	-	100/1000	53	-	10/100	27	-	10/200	73	668	1/3	52	-	1/4			
47	-	100/1000	54	-	10/100	35	666	1	76	-	2/24	53	-	1/2			
48	-	100/500	55	-	10/100	47	688	10/200	77	-	2/24	54	-	1/2			
49	-	100/2000	65	684	500	54	670	10/100	79	683	1/9	0 349 50	252	1			
50	-	100	66	-	1000	55	-	10/100	82	679	1/10	59	-	1			
51	-	50/500	67	-	1000	0 327 37	682	1/20	83	-	1/10	10	-	1/24			
61	-	100/3000	68	-	50/500	44	688	1/10	0 332 37	706	1/4	0 350 58	562	1			
63	-	100/2500	69	-	1000	45	682	10/100	38	-	1/4	0 353 06	254	1/10			
65	273	100/2000	70	-	1000/10000	46	-	10/100	60	683	1/77	07	-	1/10			

Cat.Nos	Page N°	Pack	Cat.Nos	Page N°	Pack	Cat.Nos	Page N°	Pack	Cat.Nos	Page N°	Pack	Cat.Nos	Page N°	Pack	Cat.Nos	Page N°	Pack
0 360 11	256	1/10	0 362 13	300	32	0 365 39	260	10/200	0 371 64	280	20/180	0 373 25	187	1	0 375 61	285	10/400
12	-	1/10	16	-	24	40	248	10/200	65	-	20/180	49	209	10	62	-	10/400
13	-	1	17	-	24	41	260	10/200	66	-	10/60	60	-	100/1500	63	-	10/500
14	-	1	25	-	16	42	-	10/200	67	-	60/660	61	-	10/500	65	286	10/1000
15	-	1/10	40	251	10/1000	45	-	10/200	68	-	60/600	62	-	10/500	66	-	10/500
16	-	1	42	-	1/30	51	244	1	69	-	25/500	65	-	100/2000	67	-	10/500
17	-	1	44	-	1/10	52	-	1	70	-	60/1200	85	200	1/20	68	-	10
18	-	1	46	253	1	53	-	1	71	-	50/1000	88	185	10	69	-	10
19	-	1	48	-	1	54	-	1	72	-	40/400	89	-	10	75	-	50/1000
20	-	1	50	250	1	56	-	1	73	-	30/300	95	182	1/10	76	-	20/400
21	-	1	51	-	1	57	-	1	74	-	10/100	96	187	5/60	77	-	10/360
22	-	1/5	52	-	1	64	-	1	75	-	10/100	98	-	10/500	82	285	20/880
23	-	1	55	-	1	70	263	1/20	76	-	10/180	99	183	4/40	85	-	20/880
24	-	1	56	-	1	71	262	1/10	77	-	50/1000				86	284	50/2000
25	-	1	61	-	1	74	263	1/10	78	-	40/800	0 374 00	182	1/5	87	-	50/2000
31	-	1	63	-	1	77	-	2/48	79	-	50/500	02	253	10	88	-	20/800
33	-	1	64	-	1	78	-	2/40	80	281	20/640	03	183	10/250	89	-	20/800
34	-	1	71	-	1	79	-	2/40	81	-	20/640	04	258	10	90	-	20/800
40	-	1	72	-	1	80	200	20	82	-	20/640	05	183	5/125	95	285	10/400
42	-	1	75	-	1	81	-	20	83	-	20/640	07	258	10	96	-	10/400
43	-	1	76	-	1	82	-	1/10	84	-	20/640	10	185	1			
44	259	1	81	-	1	91	245	10/100	85	-	20/640	11	-	1	0 376 06	292	1/20
45	-	1	83	-	1	97	-	1/12	86	-	20/640	12	-	1	08	-	1/15
46	256	1	84	-	1				87	-	20/200	18	-	4	09	-	1/15
47	-	1	85	252	1	0 366 38	300	1	92	-	25/250	19	-	4	10	-	1/15
48	-	1	86	-	1	39	-	1	98	280	20/180	30	182	1	39	-	1
49	-	1/10	87	-	1	40	-	100/1000	99	-	20/180	31	-	1	41	-	3000
52	-	1	91	251	1	41	-	20/200				32	187	1/8	42	-	3000
54	-	1	92	-	1	42	-	20/200	0 372 00	282	60/1500	33	185	10	43	-	3000
55	-	1	93	-	1	43	-	10/100	01	-	50/1250	34	-	10	44	-	3000
56	-	1	94	-	1	44	-	500/5000	02	-	50/550	35	182	1/5	45	-	2500
57	-	1	95	-	1	46	-	100/2000	03	-	40/440	36	187	1/10	46	293	10/200
58	-	1	96	252	1				04	-	10/260	37	-	10/100	47	-	10/200
59	-	1	97	-	1	0 367 00	300	20/200	07	-	60/720	38	185	10	48	-	10/200
60	-	1				01	-	50/1600	08	-	50/600	39	261	100/1000	50	292	500/20000
61	-	1	0 363 00	248	1	10	-	1/24	09	-	50/800	40	185	1	60	-	500/20000
63	-	1	01	-	1	35	245	5/50	10	-	40/1200	41	-	1	61	-	480/19200
64	-	1	12	244	1/10	36	258	5/50	11	-	30/900	42	182	1	62	-	480/19200
65	-	1	13	258	1/10	45	245	1/10	12	-	40/800	43	185	1	63	-	1000/40000
66	-	1	59	259	1	74	185	50/500	20	-	60/1500	46	-	1	64	-	1000/40000
67	-	1	60	-	1	75	-	50/500	21	-	50/1250	47	182	1/5	66	-	1000/40000
68	-	1	61	-	1	80	258	10	40	-	60/1200	57	185	1	67	-	250/10000
69	-	1	62	-	1	81	-	10	41	-	60/1200	58	-	1	68	-	250/10000
70	-	1	63	-	1	82	-	10	42	-	60/1200	59	-	1	69	-	100/4000
71	-	1	64	-	1	83	-	10	43	-	50/1000	67	-	1	70	-	100/4000
75	-	1	65	-	1	84	-	10	44	-	50/1000	80	183	5	71	-	50/2000
79	-	1	66	252	1	85	-	10	46	-	60/960	81	-	4	72	-	100/4000
87	-	1	67	-	1	86	-	10	47	-	60/960				77	-	50/2000
88	-	1	68	-	1				54	283	60/960	0 375 00	285	20/880	78	-	30/1200
89	-	1	69	259	1/30	0 368 04	260	10/100	55	-	60/720	01	-	20/880	87	-	500/12500
90	-	1	90	253	1	05	-	10/50	56	-	60/720	02	-	50/2200	88	-	500/12500
91	-	1	91	-	1	06	-	10/100	60	282	60/1500	03	-	20/880	89	-	500/12500
92	-	1	92	-	1	17	-	10/200	61	-	50/1250	04	-	20/880	90	-	500/10000
93	-	1	95	245	20/440	18	-	10/200	62	-	50/550	05	-	50/2200	92	-	1
94	-	1				19	-	10/200	63	-	40/440	07	-	20/880	97	-	1/4
98	-	1	0 364 01	245	1/10	20	-	10/200	64	-	10/260	08	-	20/880			
99	-	1/10	04	-	1/10	22	-	10/200	67	-	60/720	10	284	50/1000	0 377 10	297	100/10000
			08	251	1/50	23	-	10/200	68	-	50/600	11	-	20/500	12	-	100/5000
0 361 00	259	10	09	-	1/10	24	-	10/200	69	-	50/800	12	-	10/250	50	292	500/15000
01	-	1	36	-	1	25	-	10/200	70	-	60/1200	13	-	20/500	60	-	500/15000
02	-	1	37	-	1	26	-	10/200	71	-	50/1000	15	285	50/2000	61	-	1000/30000
03	-	1	39	-	1	27	-	10/200	72	-	25/250	16	-	50/2000	62	-	1000/30000
05	-	1	40	208	100/3000	42	-	1/27	73	-	20/200	17	-	50/2000	63	-	1000/30000
06	-	1	41	-	100/3000	43	-	10/100	74	-	15/150	18	-	50/2000	64	-	1000/30000
09	-	1	42	256	100/3000				79	-	30/600	21	-	20/720	66	-	1000/30000
10	-	1	50	261	20/400	0 371 00	280	60/1200	80	283	20/520	22	-	20/720	67	-	250/7500
50	258	5	51	-	20/400	01	-	50/1000	81	-	20/520	24	-	50/500	68	-	250/7500
51	-	5	52	-	20/400	02	-	40/800	82	-	20/520	25	-	50/500	80	298	600/30000
52	-	5	53	702	1/10	03	-	30/600	83	-	20/520	27	286	10/500	81	-	600/30000
53	-	5	54	-	1/20	04	-	20/180	84	-	20/520	30	-	10/440	82	-	600/30000
54	-	5	61	261	100/1000	05	-	20/180	85	-	20/520	31	-	10/440	83	-	600/30000
55	-	5	62	-	100/1000	07	-	60/660	86	-	20/520	32	-	4/176	84	-	600/30000
56	-	5	63	-	100/1000	08	-	60/600				34	-	10	85	-	600/30000
58	-	1	66	-	20/500	09	-	25/500	0 373 00	200	1/5	35	-	50/1000	86	-	600/30000
59	-	1	69	-	40/2000	20	-	60/1200	01	209	1/5	40	285	10/100	87	-	600/30000
92	-	10	78	-	100/1000	21	-	50/1000	02	-	1/5	42	-	10/100	88	-	600/30000
94	261	10	79	-	100/1000	30	-	60/1200	08	182	1	44	-	10/100	89	-	600/30000
			82	-	100/1000	31	-	50/1000	10	187	1/12	46	-	10/1000			
0 362 00	300	60	94	245	1/10	51	-	50/500	11	185	1/10	47	-	10/1000	0 378 01	298	600/30000
01	-	56	95	-	1/10	52	-	50/500	12	187	1	50	284	100/2000	02	-	600/30000
02	-	56	96	-	1/8	53	281	20/640	13	-	1	51	-	20/800	03	-	600/30000
03	-	40	97	-	1/8	54	-	20/640	14	-	1/20	52	-	20/800	04	-	600/30000
05	-	56	98	-	1/5	55	-	60/600	15	-	1/10	53	-	20/1000	05	-	600/30000
06	-	48				56	-	60/600	20	-	1/10	54	-	20/200	06	-	600/30000
07	-	48	0 365 11	260	1/10	60	280	60/1200	21	-	1	55	-	20/800	07	-	600/30000
08	-	40	13	251	1/20	61	-	50/1000	22	-	1	56	-	20/600	08	-	600/30000
11	-	32	30	260	10/100	62	-	40/800	23	-	1	57	-	10/500	09	-	600/30000
12	-	32	35	248	10/200	63	-	30/600	24	-	1	60	285	20/800	10	-	600/30000

**Bold pack quantities:** minimum quantities to be ordered. **Red catalogue number:** new products



Cat.Nos	Page N°	Pack	Cat.Nos	Page N°	Pack	Cat.Nos	Page N°	Pack	Cat.Nos	Page N°	Pack	Cat.Nos	Page N°	Pack	Cat.Nos	Page N°	Pack
0 378 26	298	240/24000	0 381 08	295	1000/50000	0 382 75	295	300/30000	0 383 79	295	300/30000	0 390 32	290	5/50	0 405 80	650	1/10
27	-	240/24000	09	-	1000/50000	76	-	300/30000	80	-	300/30000	33	-	5/50	86	-	1
28	-	240/24000	10	-	300/30000	80	-	300/30000	81	-	300/30000	34	-	5/30	87	-	1
29	-	240/24000	11	-	300/30000	81	-	300/30000	82	-	300/30000	71	-	5/100	90	-	1/10
30	-	240/24000	12	-	300/30000	82	-	300/30000	83	-	300/30000	72	-	5/50	91	-	1/10
31	-	240/24000	13	-	300/30000	83	-	300/30000	84	-	300/30000	73	-	5/50	94	-	1/10
32	-	240/24000	14	-	300/30000	84	-	300/30000	85	-	300/30000	74	-	5/30	96	649	1/20
33	-	240/24000	15	-	300/30000	85	-	300/30000	92	296	100/1000				98	-	1/10
34	-	240/24000	16	-	300/30000	86	-	300/30000	94	-	10/500	0 394 45	286	10/320			
35	-	240/24000	17	-	300/30000	90	-	300/30000	95	-	10/500	46	290	5/100	0 406 87	650	1/16
36	-	240/24000	18	-	300/30000	91	-	300/30000	96	-	10/500	47	-	5/100			
37	-	240/24000	19	-	300/30000	92	-	300/30000	97	-	10/500	49	251	10/100	0 407 47	632	1/10
38	-	240/24000	20	-	300/30000	93	-	300/30000				77	290	10/120	49	417	1/4
39	-	240/24000	21	-	300/30000	94	-	300/30000	0 384 00	571	800/40000	78	-	10/100	53	632	1
40	-	240/24000	22	-	300/30000	95	-	300/30000	01	-	800/40000	86	-	5/40			
41	-	240/24000	23	-	300/30000	96	-	300/30000	02	-	800/40000	88	-	5/50	0 408 95	623	1/20
42	-	240/24000	24	-	300/30000				03	-	800/40000	89	-	5/25	96	627	1/20
43	-	240/24000	25	-	300/30000	0 383 00	295	300/30000	04	-	800/40000				98	623	1/20
44	-	240/24000	26	-	300/30000	01	-	300/30000	05	-	800/40000	0 395 00	294	1000/25000			
45	-	240/24000	27	-	300/30000	02	-	300/30000	06	-	800/40000	01	-	1000/25000	0 412 21	581	10/50
46	-	240/24000	28	-	300/30000	03	-	300/30000	07	-	800/40000	02	-	1000/25000	43	-	1/20
47	-	240/24000	29	-	300/30000	04	-	300/30000	08	-	800/40000	05	-	1000/25000			
48	-	240/24000	30	-	300/30000	05	-	300/30000	09	-	800/40000	06	-	1000/25000	0 413 08	349	1/6
49	-	240/24000	31	-	300/30000	06	-	300/30000	10	-	600/30000	07	-	1000/25000	09	-	1/21
50	-	240/24000	32	-	300/30000	07	-	300/30000	11	-	600/30000	08	-	1000/25000	10	-	1/21
51	-	240/24000	33	-	300/30000	08	-	300/30000	12	-	600/30000	09	-	1000/25000	13	-	1/21
0 379 10	297	500/5500	34	-	300/30000	09	-	300/30000	13	-	600/30000	10	-	1000/25000	14	-	1/21
11	-	500/5500	35	-	300/30000	10	-	300/30000	14	-	600/30000	11	-	1000/25000	49	348	1/12
20	-	1000/11000	40	-	300/30000	11	-	300/30000	15	-	600/30000	15	-	1000/25000	57	349	1/6
21	-	1000/11000	41	-	300/30000	12	-	300/30000	16	-	600/30000	16	-	1000/25000	62	-	10/200
22	-	500/5500	42	-	300/30000	13	-	300/30000	17	-	600/30000	17	-	1000/25000			
27	-	1000/10000	43	-	300/30000	14	-	300/30000	18	-	600/30000	18	-	1000/25000	0 414 16	348	1/5
28	-	1000/10000	44	-	300/30000	15	-	300/30000	19	-	600/30000	19	-	1000/25000	18	-	1/5
30	-	1000/10000	45	-	300/30000	16	-	300/30000	20	-	600/30000	20	-	1000/25000	19	-	1/5
31	-	1000/10000	46	-	300/30000	17	-	300/30000	21	-	600/30000	21	-	1000/25000	39	-	1/4
32	-	500/5000	50	294	240/24000	18	-	300/30000	22	-	600/30000	96	284	20/600	62	-	1/5
33	-	500/5000	51	-	240/24000	19	-	300/30000	23	-	600/30000	97	-	20/2000			
34	-	200/2000	52	-	240/24000	20	-	300/30000	24	-	600/30000	98	273	10/500	0 415 07	650	1/20
35	-	100/1000	53	-	240/24000	21	-	300/30000	25	-	600/30000	99	245	10/200	20	348	1/10
36	-	1000/10000	54	-	240/24000	22	-	300/30000	26	-	600/30000				23	-	1/10
37	-	1000/10000	55	-	240/24000	23	-	300/30000	27	-	600/30000	0 399 30	248	1	32	-	1/12
38	-	500/5000	60	-	240/24000	24	-	300/30000	28	-	600/30000	31	-	1	33	-	1/12
40	-	500/5000	61	-	240/24000	25	-	300/30000	29	-	600/30000	32	-	1	36	-	1/12
41	-	500/5000	62	-	240/24000	30	-	300/30000	30	-	600/30000	33	-	1	38	-	1/12
42	-	200/2000	63	-	240/24000	31	-	300/30000	31	-	600/30000	34	-	1	39	-	1/12
43	-	200/2000	64	-	240/24000	32	-	300/30000	32	-	600/30000	35	-	1	45	-	1/10
44	-	10/200	65	-	240/24000	33	-	300/30000	33	-	600/30000	36	-	1			
54	298	240/24000				34	-	300/30000	34	-	600/30000	37	-	1	0 416 10	581	1/27
55	-	240/24000	0 382 00	296	1	35	-	300/30000	35	-	600/30000	38	-	1	11	-	1/27
56	-	240/24000	01	-	1/8	36	-	300/30000	40	-	600/30000	39	-	1	13	-	1/27
57	-	240/24000	02	-	1/8	37	-	300/30000	41	-	600/30000	40	-	1	17	-	1/189
58	-	240/24000	03	-	1/8	38	-	300/30000	42	-	600/30000	41	-	1	45	-	10/200
59	-	240/24000	04	-	1/8	39	-	300/30000	43	-	600/30000	42	-	1	46	-	5/100
60	-	240/24000	10	295	1200/60000	40	-	300/30000	44	-	600/30000	43	-	1	47	-	10/100
69	297	10/500	11	-	1200/60000	41	-	300/30000	45	-	600/30000	44	-	1	50	-	1/10
90	-	10/500	12	-	1200/60000	42	-	300/30000	46	-	600/30000	45	-	1	51	-	1/10
91	-	1/10	13	-	1200/60000	43	-	300/30000	50	-	100/3200	46	-	1	52	-	1/10
92	-	10/500	14	-	1200/60000	44	-	300/30000	52	-	100/3200	51	-	1			
93	-	10/500	15	-	1200/60000	45	-	300/30000	54	-	100/3200	52	-	1	0 419 00	586	10/250
0 380 00	651	1/10	16	-	1200/60000	46	-	300/30000	55	-	100/3200	54	-	1	11	-	1/20
01	-	1/10	17	-	1200/60000	47	-	300/30000	56	-	100/3200	55	-	1	12	-	1/20
02	-	1/10	18	-	1200/60000	48	-	300/30000	60	-	100/3200	56	-	1			
03	-	1/10	19	-	1200/60000	49	-	300/30000	62	-	100/3200	59	-	1	0 422 82	314	1
06	649	1/20	20	-	1200/60000	50	-	300/30000	64	-	100/3200	63	-	1	84	-	1
09	651	1/10	21	-	1200/60000	51	-	300/30000	65	-	100/3200	64	-	1	85	-	1
11	-	1/10	22	-	1200/60000	52	-	300/30000	66	-	100/3200	65	-	1	86	-	1
23	649	1/20	23	-	1200/60000	53	-	300/30000	90	296	100/2400	69	-	1	87	-	1
24	651	1/10	24	-	1200/60000	54	-	300/30000	91	-	50/1200	80	-	10/150	88	-	1
25	649	1/20	25	-	1200/60000	55	-	300/30000	92	-	50/500	81	-	10/150			
38	-	1/50	26	-	1200/60000	60	-	300/30000	96	571	1/50	86	-	10/150			
48	-	1/20	27	-	1200/60000	61	-	300/30000	97	-	100/3000	87	-	10/150	0 425 10	314	1
54	651	1/10	28	-	1200/60000	62	-	300/30000	98	-	100/5000	88	-	10/150	11	-	1
60	-	1/10	29	-	1200/60000	63	-	300/30000	99	-	600/30000				12	-	1
69	649	1/20	30	-	800/40000	64	-	300/30000							13	-	1
71	-	1/20	31	-	800/40000	65	-	300/30000	0 387 42	297	200/4000				14	-	1
91	651	10/100	32	-	800/40000	66	-	300/30000	0 389 71	261	10				15	-	1
97	649	1/20	33	-	800/40000	67	-	300/30000	0 390 10	290	5	0 401 75	580	10/100	16	-	1
0 381 00	295	1000/50000	34	-	800/40000	68	-	300/30000	11	-	5	87	-	20/200	71	823	1
01	-	1000/50000	35	-	800/40000	69	-	300/30000	13	-	5	92	-	20/200	72	-	1
02	-	1000/50000	36	-	800/40000	70	-	300/30000	14	-	5	93	-	20/200	73	-	1
03	-	1000/50000	37	-	800/40000	71	-	300/30000	15	-	5	94	-	20/200	74	-	

Cat.Nos	Page N°	Pack	Cat.Nos	Page N°	Pack	Cat.Nos	Page N°	Pack	Cat.Nos	Page N°	Pack	Cat.Nos	Page N°	Pack	Cat.Nos	Page N°	Pack
0 427 20	314	1	0 442 15	312	1	0 482 90	686	1	0 465 06	702	1	0 481 40	252	1	0 495 52	093	1/30
21	-	1	16	-	1	91	-	1	07	-	1	43	-	1	53	-	1/30
22	-	1	17	-	1	0 463 00	698	1	08	-	1	0 482 20	712	1	54	-	1/30
23	-	1	18	-	1	06	-	1	09	-	1	0 488 00	595	1/10	55	-	1/30
24	-	1	31	-	1	12	-	1	10	-	1	03	592	1/10	58	-	1/30
25	-	1	32	-	1	18	-	1	11	-	1	04	595	1/10	59	-	1/30
26	-	1	33	-	1	19	-	1	12	-	1	06	-	1/10	60	-	1/30
60	-	1	34	-	1	21	-	1	13	-	1	07	594	1/10	97	-	100
61	-	1	35	-	1	22	-	1	17	-	1	08	-	1/10	0 497 56	076	1/30
62	-	1	36	-	1	23	-	1	18	-	1	09	595	1/10	83	077	1/30
63	-	1	37	-	1	28	-	1	19	-	1	17	594	1/10	0 499 26	076	1/40
64	-	1	38	-	1	29	-	1	22	-	1/10	20	598	1/10			
65	-	1	39	-	1	30	-	1	23	-	1/8	21	-	1/10			
85	313	1	40	-	1	33	-	1	28	-	1/80	22	-	1/10			
86	-	1	41	-	1	34	-	1	29	-	1/40	23	-	1/10			
87	-	1	42	-	1	35	-	1	30	-	1/8	24	-	1/10			
88	-	1	43	-	1	37	-	1	31	-	1/4	25	-	1/10			
89	-	1	44	-	1	38	-	1	32	-	1/80	28	-	1/10			
90	-	1	45	-	1	39	-	1	33	-	1/40	30	-	1/10			
91	-	1	46	-	1	41	-	1	38	-	1/8	39	-	1/10			
92	-	1	47	-	1	42	-	1	39	-	1/4	40	-	1/4			
0 428 40	313	1	48	-	1	43	-	1	40	-	1/4	41	590	1/18			
41	-	1	49	-	1	44	-	1	41	704	4/80	42	597	1/10			
42	-	1	50	-	1	45	-	1	42	-	4/80	43	-	1/10			
43	-	1	51	-	1	46	-	1	46	706	1	44	-	1/10			
44	-	1	52	-	1	47	-	1	47	-	1	45	-	1/10			
45	-	1	53	-	1	48	-	1	50	-	1/8	47	-	1/10			
46	-	1	54	-	1	49	-	1	51	-	1/8	50	-	1/10			
47	-	1	55	-	1	50	-	1	52	-	1/8	51	-	1/10			
49	-	1	56	-	1	0 464 06	703	1	54	-	1/8	52	-	1/10			
55	-	1	61	-	1	07	-	1	60	-	8	55	-	1/10			
56	-	1	62	-	1	15	-	1	62	-	1/8	60	787	1			
57	-	1	63	-	1	16	-	1	65	-	1/8	68	596	10/100			
58	-	1	64	-	1	18	-	1	70	703	1	72	-	10/120			
59	-	1	65	-	1	19	-	1	71	-	1	73	598	10/50			
60	-	1	66	-	1	23	-	1/20	75	701	1	75	596	1/10			
61	-	1	67	-	1	25	-	1	76	-	1	0 489 11	592	1/10			
62	-	1	68	-	1	26	-	1	80	706	1	14	595	1			
66	-	1	69	-	1	27	-	1	81	-	1	16	-	1/10			
70	-	1	70	-	1	30	700	1	84	-	1	17	594	1/10			
71	-	1	71	-	1	31	-	1	85	-	1	31	592	1/10			
72	-	1	72	-	1	32	-	1	88	-	1	32	594	1			
73	-	1	73	-	1	34	-	1	89	-	1	33	-	1			
74	-	1	74	-	1	35	-	1	90	707	1/10	71	596	1/4			
75	-	1	81	-	1	36	-	1	93	-	1/6	72	-	1/4			
76	-	1	82	-	1	38	-	1	94	-	1/6	74	-	1/5			
77	-	1	83	-	1	39	-	1	95	-	1/6	75	-	1			
79	-	5/120	84	-	1	40	-	1	96	-	1/10	0 490 29	396	1			
0 431 00	631	10/100	85	-	1	51	-	1	0 466 23	087	1/20	30	-	1			
01	-	10/100	86	-	1	52	-	1	0 470 21	322	1	0 491 20	068	10/100			
08	-	1/10	87	-	1	53	-	1	22	-	1	21	-	10/100			
10	-	1/25	88	-	1	54	-	1	23	-	1	0 492 00	412	10/30			
12	-	1/4	89	-	1	56	-	1	24	-	1	01	-	10/30			
17	-	1/20	90	-	1	58	-	1	25	-	1	02	-	10/30			
18	-	1/20	91	-	1	60	-	1	26	-	1	03	-	10/30			
19	-	1/20				61	-	1	28	-	1	04	-	10/30			
42	-	1/20				62	-	1	29	-	1	05	-	1/10			
43	-	1/20				63	-	1	0 472 72	712	1	06	-	1/10			
45	-	1/10				64	-	1/4	75	-	1	07	-	10/30			
0 432 60	631	1/4	0 450 00			66	-	1	0 473 62	712	1	08	-	10/30			
61	-	1/10	01	-	1	69	701	1	63	-	1	09	-	10/30			
63	-	1/4	02	-	1	70	-	1	91	-	1	10	-	5/15			
0 433 01	628	1	03	-	1	72	-	1	92	-	1	11	-	5/15			
02	-	1	06	-	1	73	-	1	0 474 90	252	1	12	-	5/15			
11	630	1	07	-	1	74	-	1	95	-	1	13	-	5/15			
13	-	1	08	-	1	76	-	1	0 475 45	258	1	14	-	5/15			
14	-	1	09	-	1	77	-	1	46	-	1	15	-	5/15			
15	-	1	11	-	1	78	698	1	47	-	1	16	-	5/15			
16	-	1	12	-	1	79	-	1	83	701	1	17	-	5/15			
17	-	1	13	-	1	80	701	1	84	-	1	18	-	5/15			
18	-	1	14	-	1	81	-	1	85	702	1	19	-	5/15			
30	632	1	20	705	1	82	698	1	86	701	1/10	20	-	5/15			
92	631	1/20	23	-	1/12	83	701	1	87	-	1	21	-	5/15			
95	632	1/6	24	-	1/10	84	-	1	88	-	1	22	-	10/240			
0 442 01	312	1	25	-	1/10	85	702	1	89	-	1	31	-	1			
02	-	1	26	-	1/10	86	701	1/10	90	-	1	32	-	1			
03	-	1	27	258	1	87	-	1	98	711	1	33	813	1			
04	-	1	28	-	1	88	-	1	99	-	1	34	412	1/3			
05	-	1	29	-	1	89	-	1	0 465 00	702	1	44	420	10/240			
06	-	1	35	710	1	90	-	1	01	-	1	45	-	10/240			
11	-	1	36	-	1	98	711	1	02	-	1	46	-	10/240			
12	-	1	47	-	1	99	-	1	05	-	1	49	421	1/4			
13	-	1	48	-	1	0 465 00	702	1	01	-	1	65	412	1/78			
14	-	1	55	704	1	01	-	1	02	-	1	74	-	1			
			60	-	1/10	02	-	1	23	-	10						
			64	-	1	28	-	1	253	5							
			70	710	1	05	-	1									

**Bold pack quantities:** minimum quantities to be ordered. **Red catalogue number:** new products

Cat.Nos	Page N°	Pack	Cat.Nos	Page N°	Pack	Cat.Nos	Page N°	Pack	Cat.Nos	Page N°	Pack	Cat.Nos	Page N°	Pack	Cat.Nos	Page N°	Pack
0 506 62	576	10/60	0 517 81	669	5/50	0 522 03	340	1/10	0 529 84	341	1/12	0 540 26	777	1/12	0 566 61	339	1
63	-	10/60	82	-	5/50	04	-	1/10	90	340	1/5	28	-	1/6	65	-	1
65	-	5/30	83	-	5	13	-	1/5	93	341	5/20	31	-	1/12	66	-	1
73	574	1/8	86	676	1/4	14	-	1/5	94	-	1/12	33	-	1/6	69	-	1
			87	-	1/4	19	-	5/60				34	-	1	73	-	1
			88	-	1/4	20	-	1/20				36	-	1	74	-	1
0 507 67	579	1	90	677	1/4	23	-	5/50	0 530 06	342	1/10	44	-	1			
69	-	1	91	-	1/4	24	-	5/50	10	-	1/10	45	-	1	0 568 03	328	5/20
			92	-	1/4	29	-	5/50	11	-	1/10	46	-	1	04	-	5/20
0 511 06	342	1/10	93	-	1/4	33	-	1/15	46	-	1/12	47	-	1	07	-	5/20
10	-	1/10	94	-	1/4	34	-	1/20	50	-	1/12	60	779	10/100	08	-	5/20
11	-	1/10	95	-	1/4	39	-	5/20	51	-	1/12	61	-	10/100	23	-	5/20
26	-	5/50	96	676	1/4	43	341	5/50	56	-	1/10	62	-	10/100	27	-	5/20
30	-	1/12	97	-	1/4	44	-	5/25	60	-	1/10	63	-	10/100	28	-	5
31	-	1/12	98	-	1/4	49	340	1/10	61	-	1/10	65	-	1/16			
46	-	1/30				53	341	5/50	76	-	1/10	66	-	1/16	0 572 98	339	1
50	-	1/12	0 518 50	673	1/20	54	-	5/25	80	-	1/10	67	-	1/16	99	-	1
51	-	1/12	51	-	1/20	59	340	1/5	81	-	1/10	70	-	1/10			
56	-	5/20	52	-	1/20	63	341	5/50	86	-	1/10	71	-	1/10	0 573 00	326	1/4
60	-	5/25	53	-	1/20	69	-	1/10	90	-	1/10	72	-	1/10	01	-	1/4
61	-	5/20	54	-	1/20	73	-	1/10	91	-	1/10	73	-	1/10	02	-	1/4
76	-	1/20	55	-	1/20	74	-	1/10	0 533 00	683	3/30	75	-	1/28	20	-	1/4
80	-	1/12	56	-	1/20	79	-	1/10	01	-	3/30	80	-	1/10	21	-	1/4
81	-	1/10	57	-	1/20	83	-	5/50	02	-	3/30	81	-	1/10	22	-	1/4
86	-	1/10	58	-	1/20	84	-	1/20	03	-	3/12	82	-	1/10	54	-	5/50
90	-	1/10	59	-	1/20	89	340	1/5	0 535 90	780	1/10	85	-	1/10	58	-	5/50
91	-	1/10	60	-	1/20	93	341	5/25	91	-	1/10	86	-	1/10	59	-	5/50
			61	-	1/20	94	-	1/20	92	-	1/5	87	-	1/10			
0 513 66	575	5	62	-	1/20				98	-	1/5	88	-	1/5	0 574 40	326	5/20
69	-	5	63	-	1/20	0 524 01	340	5/50	99	-	5/25	90	-	1/10	41	-	5/20
			64	-	1/20	19	-	5/50				91	-	1/10			
0 515 00	677	4	65	-	1/20	21	341	5/50	0 536 03	340	1	92	-	1/10	0 575 84	326	5/50
01	-	4	66	669	1/10	41	-	5/50	04	-	1	96	-	1/10	85	-	5/25
02	-	4	67	-	1/10	61	-	1/20				97	-	1/10	86	-	5/25
03	-	4	68	-	1/10	81	-	1/20	0 537 23	340	1	98	-	1/5	88	-	5/25
04	-	4	69	-	1/5				24	-	1				89	-	5/25
05	-	4	70	-	1/10	0 525 01	340	1/30	33	-	1						
10	676	4	71	-	1/10	21	341	1/20	34	-	1				0 576 69	327	20/100
11	-	4	72	-	1/10	41	-	1/20	49	-	1				72	-	20
12	-	4	73	-	1/5	61	-	1/20	73	341	1/5				75	-	20/100
13	-	4	74	-	1/10	81	-	1/20	74	-	1/5				76	-	20
14	-	4	75	-	1/10				0 538 00	340	1	0 552 06	327	5/50			
15	-	4	76	-	1/10	0 527 02	340	1/6	01	-	1	21	-	5/50			
23	-	1/4	77	-	1/5	18	-	1/12	09	-	1	31	-	5/50	0 577 03	336	1
24	-	1/4	78	-	1/10	32	-	1/12	23	-	1/10	41	-	5/50	04	-	1
25	-	1/4	79	-	1/10	42	341	1/20	24	-	1/10	45	-	5/50	05	-	1
			80	-	1/10	62	-	1/10	33	-	1/10	56	-	5/50	06	-	1
0 516 36	679	1/20	81	-	1/5	72	-	1/10	23	-	1/10	71	-	5/50	10	-	1/2
37	-	1/20	82	-	1/10	82	-	1/10	24	-	1/10	81	-	5/50	11	-	3
38	-	1/20	83	-	1/10	92	-	1/10	34	-	1/10	91	-	5/50	12	-	5
39	-	1/20	84	-	1/10	99	326	1/50	43	341	1/5	95	-	5/50	13	-	5
40	-	1/20	85	-	1/5				44	-	1/5				14	-	4
41	-	1/20				0 520 02	340	1/10	53	-	1/5	0 557 03	548	10/50	15	-	5
42	-	1/20	12	-	1/5	12	-	1/5	54	-	1/5	06	-	10/50	16	-	4
43	-	1/20	18	-	5/60	0 528 43	341	1/20	63	-	1	08	-	10/50	17	-	2
94	425	10/100	22	-	5/60	44	-	1/10	64	-	1	0 558 72	549	5/25	18	-	4
			29	-	5/50	53	-	1/10	73	-	1	75	-	5/25	19	-	2
0 517 01	683	50/1000	32	-	1/20	62	-	1/10	74	-	1	77	-	5/25	20	-	1
02	-	50/1000	39	-	1/20	63	-	1/10	79	-	1/5				21	327	3
03	-	50/1000	42	341	5/50	64	-	1/10	83	-	1/5	0 564 53	324	5/50	22	-	3/12
04	-	50/1000	49	340	1/10	72	-	1/10	84	-	1/5	57	-	5/50	23	336	1
06	-	50/1000	52	341	5/50	73	-	1/10	89	340	1	58	-	5/50	0 580 54	326	5
07	-	50/1000	59	340	1/10	74	-	1/10	93	341	1/5	59	-	5/25	58	-	5
09	-	1/10	62	341	5/50				94	-	1/5	77	-	5/25	59	-	5
20	457	1/5	69	-	1/20	0 529 03	340	1/6				78	-	5/25			
22	-	1/5	72	-	1/10	04	-	1/6	0 539 48	327	1/8				0 581 40	326	5/15
23	696	1/5	79	-	1/20	13	-	1/6	49	682	5/25	0 565 03	325	5/25	41	-	5/15
24	-	1/5	82	-	5/50	14	-	1/6				23	-	5/20			
25	-	1/5	89	340	1/12	19	-	1/12	0 540 00	777	1/21	28	-	5/20	0 582 84	326	5/20
26	-	1	92	341	1/20	20	-	1/12	01	-	1/18				86	-	5/20
27	-	1				33	-	1/12	02	-	1/9	0 566 01	339	1	88	-	5/20
40	682	10/100	0 521 05	327	10/50	34	-	1/12	03	-	1/8	05	-	1	89	-	5/20
41	-	10/100	25	326	10/100	39	-	1/10	05	-	1/12	06	-	1			
44	-	5/50	26	-	5/50	40	-	1/10	06	-	1/12	09	-	1	0 587 00	329	2
52	673	5/50	27	-	5/50	43	341	5/15	07	-	1/12	13	-	1	01	325	2
53	-	5/50	42	341	1/20	44	-	5/15	08	-	1/12	14	-	1	02	-	2
54	-	5/50	43	-	1/20	49	340	1/10	10	-	1/12	21	-	1	04	329	2
55	-	5	44	-	1/20	53	341	5/15	11	-	1/12	25	-	1	05	-	2
57	676	1/4	52	-	1/10	54	-	1/10	12	-	1/6	26	-	1	10	-	2
58	-	1/4	53	-	5/25	59	340	1/10	13	-	1/6	29	-	1	11	325	2
59	-	1/4	54	-	1/10	63	341	1/10	15	-	1/12	33	-	1	12	-	2
62	673	1/20	62	-	1/12	64	-	1/10	16	-	1/12	34	-	1	14	329	2
63	-	1/20	63	-	1/10	69	-	1/10	17	-	1/6	41	-	1	15	-	2
64	-	1/20	64	-	1/10	73	-	1/10	18	-	1/6	45	-	1	20	-	2
65	-	1/20	72	-	1/12	74	-	1/10	20	-	1/12	46	-	1	21	325	2
72	-	1/20	73	-	1/10	79	-	1/10	21	-	1/12	49	-	1	22	-	2
73	-	1/20	74	-	1/10	83	-	1/10	22	-	1/6	53	-	1	24	329	2
74	-	1/20							23	-	1/6	54	-	1	25	-	2
75	-	1/20															
80	669	5/50															

**Bold pack quantities:** minimum quantities to be ordered. **Red catalogue number:** new products

Cat.Nos	Page N°	Pack	Cat.Nos	Page N°	Pack	Cat.Nos	Page N°	Pack	Cat.Nos	Page N°	Pack	Cat.Nos	Page N°	Pack	Cat.Nos	Page N°	Pack
0 587 30	329	2	0 610 18	616	1/12	0 673 30	461	1	0 696 85	553	5/50	0 756 41	747	10	0 765 22	674	10/100
34	-	2	19	-	1/12				89	-	10/100	42	-	10	23	-	10/100
35	-	2	87	617	1/20	0 674 59	395	1/12	90	-	5/50	43	748	5	24	670	10/100
40	-	2	92	-	1/12				91	-	5/50	44	-	1/5	25	-	10/100
41	325	2	93	-	1/10	0 675 13	417	1/120	92	-	10/100	46	749	5	26	-	10/100
42	-	2	96	-	1/12	14	-	1/20	94	-	5/50	61	747	10/100	27	-	10/100
44	329	2	97	-	1/12	16	-	1/24	96	-	5/50	62	-	10/100	30	680	1/20
45	-	2	98	-	1/10	17	416	5/100				63	748	10/100	32	674	1/20
						18	415	1/24	0 697 11	549	10/100	66	747	20/200	33	-	1/20
0 589 10	339	1	0 612 00	616	5/500	52	409	1/12	12	-	10/100	67	-	20/200	35	682	10/100
18	-	1	01	-	5/500	53	-	1/12	13	-	5/50	69	-	10/100	36	-	10/100
38	336	1	02	-	5/500	54	-	1/3	15	-	10/100	71	-	5/25	37	-	10/100
						55	418	1/12	16	-	5/50	72	-	5/25	38	-	10/100
0 591 06	329	1	0 617 21	609	10	56	409	1/12	17	-	1/10	75	748	5/25	39	-	10/100
07	-	1	97	617	40	57	-	1/12	20	-	10/100	76	747	5/25	41	680	5/50
14	342	1				58	-	1/12	22	-	10/100	81	-	5	42	-	5/50
15	-	1	0 618 40	620	1/10	71	396	1/20	31	-	10/100	88	-	5/25	44	674	5/50
16	329	1	42	-	1/10	72	-	1	32	-	10/50	90	746	10/100	46	-	5/50
17	-	1	46	-	1/10	89	395	1/50	33	-	10/100				51	680	10/100
26	-	1	82	617	1	90	395	1/12	39	-	5/25	0 757 00	816	20	52	-	10/100
27	-	1	83	-	1/10	91	-	1/12	40	-	1/12	02	-	12	54	-	10/100
36	-	1	84	-	1/10	92	-	1/12	50	-	5/50	04	817	8	55	-	10/100
37	-	1	85	-	1/20	93	-	1/12	80	-	1/12	05	816	10/50	61	674	10/100
46	-	1	86	-	1/20	95	-	1	95	791	1/10	07	-	5/25	62	-	10/100
47	-	1				96	-	1				09	817	5/25	63	-	10/100
			0 620 20	602	1				0 698 11	548	10/140	10	816	10/40	64	-	10/100
0 594 27	342	1/10				0 676 22	790	1/20	21	-	10/140	12	-	5/20	65	-	10/100
28	-	1/10	0 622 32	579	1	64	785	10/100	24	-	5/50	14	817	5/20	66	-	10/100
37	-	1	33	-	1	65	-	10/500	31	-	10/120	15	816	10/50	71	670	10/100
38	-	1	40	-	1/10	66	-	10/500	33	-	10/120	17	-	5/25	73	-	10/100
47	-	1/5	41	-	1/10	67	-	10/500	51	-	10/100	19	817	5/25	74	-	10/100
48	-	1/5				68	-	10/500	55	-	5/50	20	816	10	76	-	10/100
77	-	1/6	0 624 00	603	5				61	-	5/50	22	-	5	81	674	10/100
78	-	1/6	02	-	5	0 695 00	550	1/10	64	-	5/50	24	817	5	82	-	10/100
87	-	1/5	10	602	1	02	-	1/10	69	-	10/100	25	-	5/25	83	-	10/100
88	-	1/5	11	-	1	03	405	1/10	70	-	10/100	29	-	20	84	670	10/100
			12	-	1	04	551	5/100				30	-	20/200	90	-	5/50
0 595 02	342	1	15	603	1/6	11	550	10/100	0 707 11	550	5/100	35	-	10/100	91	674	10/100
03	-	1	20	602	1	12	-	10/100	21	551	5/100	36	-	10/100	92	-	10/100
12	-	1	21	-	1	13	-	5/100	22	-	5/100	50	745	20	93	-	10/100
13	-	1	25	603	5	17	551	5/100	24	552	1/10	52	-	12	94	-	5/50
22	-	1/4	49	-	1/6	18	-	5/100	26	550	5/100	55	-	10/50	95	-	5/50
23	-	1/4				23	550	5/100	27	-	5/100	60	-	10/40	96	-	5/50
32	-	1/4	0 626 00	618	1/6	24	-	1/10	30	-	5/100	62	-	5/20	97	680	5/50
33	-	1/4	01	-	1/3	25	-	10/100	32	-	5/100	65	-	10/50	98	-	5/50
42	-	1	02	-	1/12	27	-	1/10	33	-	5/100	67	-	5/25	99	670	5/50
43	-	1	03	-	1/8	28	-	1/10	41	553	10/100	70	-	10			
			10	-	1/40	30	-	10/100	42	-	1/20	72	-	5	0 766 01	791	1/20
			90	616	1/10	34	551	1/10	43	-	1/20	75	-	5/25	02	-	1/20
			91	-	1/6	35	-	1/10	49	-	1/20	79	-	20	03	812	1
			92	-	1	40	550	10/100	51	-	5/100	80	-	20/200	04	-	1
			93	-	1/8	42	-	10/100	55	-	5/100	85	-	10/100	05	-	1
			99	611	1/75	47	551	1/10	56	552	1/20	86	744	10/100	06	-	1/4
						48	-	1/10	57	-	1/20				07	-	1/4
			0 634 35	419	1	49	-	1/10	61	-	1/20	0 728 42	489	10/20	08	-	1/4
			36	417	1	53	-	10/100	69	-	5/100	43	-	100	09	813	1/4
			42	421	1/5	55	-	5/100	70	551	10/100	44	-	10/20	10	814	1/3
						56	552	1/20	71	-	10/100	46	-	10/20	11	813	1/4
						57	-	1/20	76	552	5/50				12	-	1
						61	-	1/20	77	-	5/50	0 750 00	747	20	13	-	1
						69	-	5/100	79	-	1/10	02	-	12	14	-	1/3
						70	551	10/100	80	-	10/100	04	751	8	15	814	1/4
						71	-	10/100	81	675	1/10	05	750	10/50	16	-	1
						76	552	5/50	82	552	1/10	07	-	5/25	17	813	1/3
						77	-	5/50	85	551	10/100	09	751	5/25	18	-	1/4
						79	-	1/10				10	750	10/40	19	-	1/3
						80	-	10/100	0 756 01	747	20	12	-	5/20	20	815	1/100
						81	675	1/10	02	-	12	14	751	5/20	21	-	1/24
						82	552	1/10	03	748	12	15	750	10/50	22	-	1/7
						85	551	10/100	04	-	8	17	-	5/25	29	813	1
			0 672 05	420	1				06	749	8	19	751	5/25	40	794	10/100
			31	403	1/10				08	747	20	20	750	10	41	-	10/100
			33	-	1/10				09	745	26	22	-	5	42	-	1/20
			34	-	1/10	0 696 04	551	5/100	11	747	10/50	24	751	5	55	809	1/4
			35	404	1/10	11	550	10/100	12	-	10/50	25	750	5/25	56	-	1/4
			36	-	1/10	12	-	5/100	13	748	5/25	29	-	20	57	-	1/10
			37	403	1/10	13	-	5/100	14	-	5/25	30	-	10/100	60	-	1/4
			39	404	1/10	21	551	10/100	16	749	5/25	33	-	20/200	63	-	1/20
			40	-	1/10	39	-	10/100	17	747	10/40	35	-	10/100	64	-	1/20
			50	406	1/12	40	-	5/100	22	-	10	36	-	10/100	66	786	1/20
			63	403	1/10	40	-	5/100	23	748	5/20				70	812	1/10
			64	404	1/10	56	-	5/50	24	-	5/20	0 765 01	680	10/100	71	-	1/12
			67	421	1	61	-	5/50	26	749	5/20	02	-	5/50	72	809	1/12
			68	-	1	68	-	5/50	31	747	10/50	03	674	10/100	77	811	1/20
						72	-	5/50	32	-	10/50	04	-	5/50	85	810	1/20
			0 673 22	461	1/20	78	-	5/50	33	748	5/25	05	-	10/100	90	790	1/20
			27	-	1/25	81	-	10/100	34	-	5/25	06	-	5/50			
			29	-	1/4	83	-	5/50	36	749	5/25	07	-	10/100			

**0 600 00**

**0 700 00**

**0 750 00**

Cat.Nos	Page N°	Pack	Cat.Nos	Page N°	Pack	Cat.Nos	Page N°	Pack	Cat.Nos	Page N°	Pack	Cat.Nos	Page N°	Pack	Cat.Nos	Page N°	Pack
0 767 00	625	1	0 772 42	746	10/50	0 778 44	556	1/10	0 784 07	787	1/40	0 787 26	806	10/100	0 790 08	807	1/20
03	623	1/10	43	-	10/50	50	557	1/10	10	-	1/20	30	797	10/100	10	806	1/20
04	627	1/10	45	792	10/100	51	-	1/40	20	789	1/20	31	-	10/100	11	-	5/50
05	-	1/10	52	-	10/100	52	-	1/10	25	-	1/20	32	-	10/100	14	-	5/50
06	-	1/10	53	-	10/60	53	-	1/10	27	790	1/10	34	-	10/100	15	-	5/50
07	623	1/5	54	-	5/50	56	554	1/10	28	-	1/20	46	-	1/10	16	-	5/50
08	627	1	72	-	10/100	57	-	1/10	45	791	1/20	47	695	1/10	18	-	5/50
09	-	1/4	73	-	10/60	66	557	1/20	52	595	1/30	48	797	1	22	-	5/50
10	623	5/100	74	-	5/50	67	556	1/10	53	-	1/30	50	695	10/100	23	-	5/50
11	-	10/250	81	-	10/100	68	-	1/10	54	592	1/30	51	-	10/100	25	-	5/50
12	627	10/250	82	-	10/60	70	625	1/10	55	-	1/30	52	-	1/20	28	807	1/10
13	-	10/250	83	-	5/50	71	626	1/10	57	594	1/30	53	-	1/20	30	-	1/20
16	626	1/10	90	-	10/100	72	556	1/10	71	599	1/12	54	-	1/20	32	-	1/20
17	625	1/10	91	-	10/100	73	625	1/10	72	-	1/12	55	-	1/20	36	-	1/20
18	623	1	92	-	10/100	74	556	1/10	73	-	1/12	56	-	1/20	37	-	1/20
20	789	1/20				75	-	1/10	75	-	1/12	57	694	1/20	38	-	1/20
21	-	1/12	0 774 01	758	10/100	76	-	1/10	78	-	1/3	58	695	1/20	72	805	1/10
23	-	1/20	02	-	10/60	78	-	1/10	80	791	1/20	60	-	1/20	73	-	1/10
28	623	1/20	03	-	10/50	80	557	1/20	85	598	1/30	61	797	1/20	74	-	1/5
30	-	1	04	-	5/50	81	-	1/20	86	-	1/30	64	694	1/20	82	-	1/10
31	626	1/5	11	-	10/100	82	-	1/10	89	599	1/20	65	797	1/20	83	-	1/10
32	-	1	12	-	10/60	83	-	1/50	91	-	1/20	66	-	1/20	84	-	1/5
33	621	1/2	13	-	10/50	84	-	1/20	94	-	1/20	67	-	1/20			
34	-	1/2	14	-	5/50	85	-	1/30	95	-	1/20	68	694	1/20	0 791 04	808	10/500
41	622	1	21	-	10/100	86	-	1/20	96	-	1/20	70	-	1/10	06	-	10/500
42	-	1	22	-	10/60	87	-	1/40				71	695	1/20	10	-	10/500
43	625	1	23	-	10/50	90	-	1/10	0 785 01	802	10/100	72	694	1/20	27	790	1/10
44	626	1	24	-	5/50	91	-	1/10	02	-	10/100	73	-	1/20	28	-	1/20
						92	-	1/10	10	-	1/20	74	-	1/20	51	807	10/500
0 770 00	784	10/100	0 775 01	793	10/100	96	-	5/200	11	-	1/20	76	695	1/20	52	-	10/500
01	-	10/100	02	-	10/100	97	554	1/10	12	-	1/10	77	694	1/10	53	803	10/200
02	-	10/100	03	-	10/100	98	-	1/10	13	-	1/10	78	-	1/10	54	-	10/200
10	-	10/100	04	-	10/100				20	-	5/50	79	-	1/10	71	599	1/12
11	-	10/100	05	-	10/100	0 779 00	693	1/20	21	-	5/50	80	798	10/100	72	-	1/12
12	-	10/100	06	-	10/100	01	-	1/20	22	-	1/20	82	-	10/100	73	-	1/12
14	-	1/20	08	-	10/100	05	687	1/12	23	-	1/20	83	-	10/100	75	-	1/12
21	-	10/100	09	-	10/100	06	-	1/12	24	-	5/50	84	-	10/100	78	-	1/3
25	790	10/100	10	-	10/100	13	692	1/10	51	-	10/100	86	-	10/100			
26	-	10/100	11	-	10/100	14	-	1/10	52	-	10/100	87	-	10/100	0 792 01	784	10/100
27	784	1/20	12	-	10/40	30	457	1/45	60	-	10/100	88	-	10/100	02	-	10/100
28	790	10/100	21	794	1/12				61	-	10/100	91	694	1/10	07	787	1/40
30	785	10/100	22	-	1/12	0 782 00	812	1/20	62	-	10/100	93	798	5/50	11	784	10/100
31	-	10/100	31	-	1/12	04	809	1/20	63	-	10/100	97	697	1	12	-	10/100
32	-	10/100	32	-	1/12	07	810	1/20	70	-	10/100	98	-	1	13	792	10/100
33	-	10/100	33	-	1/12	12	809	1/12	71	-	10/100	99	694	1/30	21	784	10/100
40	-	10/100	34	-	1/12	14	-	1	72	-	10/100				25	790	1/20
41	-	10/100	40	-	1/20	19	812	1	73	-	10/100				26	-	1/20
42	-	10/100	41	-	1/50	40	810	1/6				0 788 01	806	10/100	28	-	1/20
43	-	10/100	42	-	1/20	41	811	1/6	0 786 02	797	10/100	02	-	10/200	30	785	10/100
44	784	1/20	50	-	10/100	42	810	1/6	03	-	10/100	03	-	10/100	31	797	10/100
47	791	5/50	51	-	10/100	43	-	5/50	04	-	10/100	04	-	10/100	32	785	10/100
48	-	5/50	52	-	10/100	44	-	1/6	06	674	10/100	06	-	10/100	40	-	10/100
50	784	10/100	86	791	1/6	45	811	1/6	07	-	10/100	08	807	2/40	42	-	10/100
52	-	10/100	91	793	10/100	46	810	1/4	09	797	10/100	10	806	2/40	50	695	10/100
60	-	10/100	93	-	1	47	-	1/4	10	-	10/100	11	-	10/100	52	786	1/30
62	-	10/100	94	-	5/50	48	-	1/10	11	-	10/100	14	-	10/100	53	-	1/30
63	-	10/100				49	-	1/10	12	-	10/100	15	-	10/100	54	695	1/20
64	-	10/100	0 776 01	758	10/100	51	-	1/20	14	685	1/20	16	-	10/100	55	-	1/20
70	794	10/100	02	-	10/70	59	809	1/12	16	-	1/20	18	-	10/100	57	694	1/20
71	-	10/100	03	-	10/60	89	814	1/12	17	-	1/20	22	-	10/100	58	786	1/30
72	791	1/20	04	-	5/50	90	814	1/12	18	-	1/20	23	-	10/100	59	-	1/30
73	-	1/20	11	-	10/100	0 783 29	818	1	20	677	10/100	25	-	10/100	64	694	1/20
74	-	1/20	12	-	10/70	30	-	1	21	-	10/100	28	807	1/10	66	794	10/100
75	-	1/20	13	-	10/60	31	-	1	22	-	10/100	30	-	5/50	70	794	10/100
80	793	1/50	14	-	5/50	32	-	1	23	-	10/100	32	-	5/50	75	694	1/20
92	784	10/100	21	-	10/100	36	819	1	24	-	10/100	36	-	5/50	80	794	10/100
94	-	10/100	22	-	10/70	42	-	1	25	-	10/100	37	-	5/50	82	792	10/100
			23	-	10/60	45	820	1	26	-	10/100	38	-	5/50	83	-	10/60
0 771 06	746	10/120	24	-	5/50	50	-	1	27	-	10/100	40	805	1/20	84	797	1/20
50	793	10/100				51	-	1/4	28	-	10/100	54	807	10/100	92	798	10/100
			0 778 11	556	1/10	52	-	1/4	29	-	10/100	56	-	10/100	96	-	10/100
0 772 02	746	10/50	12	-	1/10	53	-	1/4				64	-	10/100			
03	-	10/50	13	-	1/10	62	809	1/20	0 787 02	792	10/100	66	-	10/100	0 793 77	694	1/10
10	792	10/100	14	-	1/10	75	811	1/20	05	790	10/100	72	805	1/10	78	-	1/10
11	-	10/100	21	-	1/10	76	-	1/20	09	786	1/20	73	-	1/10	79	-	1/10
12	-	10/100	22	-	1/10	77	-	1/10	10	784	10/100	74	-	1/5	91	793	10/100
13	-	10/100	23	-	1/10	78	-	1/10	11	-	10/100	80	806	5/150	93	-	1
14	-	10/100	25	-	1/10	79	-	1/10	12	-	10/100	82	805	1/10	94	-	1/20
16	-	10/100	27	-	1/10	85	820	1	13	786	1/20	83	-	1/10			
17	-	10/100	31	557	1/10	86	-	1	14	785	10/100	84	-	1/5	0 794 12	674	10/100
18	-	10/100	32	-	1/10	87	818	1	15	-	10/100				13	-	10/100
19	-	10/100	33	-	1/10	88	820	1	16	-	10/100	0 789 09	697	1	33	-	1/20
20	-	10/100	35	-	1/10	97	-	1	20	794	10/100	10	-	1	51	680	10/100
22	746	10/50	36	-	1/10				21	-	10/100				52	-	10/100
23	-	10/50	37	-	1/10	0 784 02	787	1/20	22	806	10/100	0 790 01	806	5/50	54	-	10/100
31	792	1/20	41	556	1/10	03	-	1	23	-	10/100	02	-	10/100	55	-	10/100
32	744	10/50	42	-	1/10	04	-	1/20	24	-	10/100	03	-	5/50	61	674	10/100

Cat.Nos	Page N°	Pack	Cat.Nos	Page N°	Pack	Cat.Nos	Page N°	Pack	Cat.Nos	Page N°	Pack	Cat.Nos	Page N°	Pack	Cat.Nos	Page N°	Pack
0 794 65	674	10/100	0 819 40	567	50	0 896 37	772	5	0 955 15	269	10/100	2 810 14	500	10/60	2 811 90	514	10/100
71	670	10/100	60	-	20	38	-	5	16	-	10/100	15	-	10/60	91	-	5/50
73	-	10/100	72	-	20/200	39	776	6/36	17	-	10/60	16	-	10/60	92	-	5/50
74	-	10/100	0 844 24	417	1	44	772	1/10	18	-	2/40	17	-	10/60	93	-	5/50
76	-	10/100	0 849 00	552	100/2000	49	-	1/10	19	-	2/40	40	502	10/60			
81	674	10/100	01	-	50/1000	83	776	1	0 968 00	267	50/3000	41	-	10/60	2 812 75	509	5/30
85	-	10/100				84	-	1	01	-	50/1250	45	506	10/60			
86	-	10/100				85	-	1	03	-	50/800	46	-	10/60	2 813 16	511	5/50
92	-	10/100				86	-	1	05	-	50/500	48	-	1/30	17	-	5/30
						87	-	1/10	06	-	25/250	50	501	10/60	18	-	5/50
						88	-	1	07	-	10/140	51	-	10/60	19	-	5/30
						90	772	1/5	08	-	10/100	52	-	10/60			
						91	-	1/5	09	-	10/90	53	-	10/60	2 816 16	511	5/50
						94	-	1/5	20	-	50/3500	54	-	10/60	17	-	5/30
						95	-	1/5	21	-	50/2000	55	-	10/60	18	-	5/50
									22	-	50/1400	60	-	10/60	19	-	5/30
									23	-	50/1150	61	-	10/60			
									24	-	50/900	62	-	10/60	2 817 16	511	5/50
									25	-	50/450	65	-	10/60	17	-	5/30
									26	-	25/300	66	-	10/60	18	-	5/50
									27	-	10/150	67	-	10/60	19	-	1
									28	-	10/100	68	-	10/60			
									29	-	10/100	69	-	4/40	2 818 47	505	8/80
									30	-	50/10000	71	-	10/60	48	512	8/80
									31	-	50/7500	72	-	10/60	55	505	5/50
									32	-	50/6000	73	-	5/30	56	512	5/50
									33	-	50/4000	75	502	5/30	58	505	5/50
									34	-	50/3500	80	-	1/30	59	512	5/50
									35	-	50/2250	81	-	1/30	67	-	8/80
									36	-	25/1000	82	-	1/30	68	-	8/80
									37	-	10/600	84	-	1/30	75	-	5/50
									38	-	10/500	85	-	1/20	76	-	5/50
									39	-	10/450	90	-	1/30	78	-	5/50
									40	-	50/11500	91	-	1/30	79	-	5/50
									41	-	50/7500	92	-	1/30	95	514	5/150
									43	-	50/4000	97	506	5/50	96	-	5/150
									45	-	50/2500				97	-	5/150
									46	-	25/1250	2 811 00	505	10/60			
									47	-	10/800	01	-	10/60	2 819 00	514	10/100
									48	-	10/450	02	-	10/60	01	-	5/50
									49	-	10/400	03	-	10/60	02	-	5/50
									0 969 29	575	10/100	04	-	10/60	05	-	10/100
									0 979 90	269	50/2500	06	-	10/60	06	-	5/50
									0 980 00	268	25/500	07	-	10/60	07	-	5/50
									01	-	25/500	08	-	10/60	10	-	10/100
									02	-	25/500	09	-	10/60	11	-	5/50
									03	-	25/500	10	504	10/60	12	-	5/50
									04	-	10/200	11	-	10/60	12	-	5/50
									05	-	10/200	12	-	5/30	20	512	1/50
									06	-	5/100	13	-	5/30	21	-	1
									07	-	3/60	14	-	10/60	22	-	1
									08	-	2/40	15	-	5/30	23	-	1
									09	-	2/40	16	-	10/60	30	-	5/50
									20	-	25/500	17	-	5/30	31	-	5/50
									21	-	25/500	18	-	10/60	32	-	5/50
									22	-	25/500	19	-	5/30	33	-	5/50
									23	-	25/500	20	505	10/60	34	-	5/50
									24	-	20/400	26	-	10/60	46	-	5/50
									25	-	10/200	27	504	10/60	47	-	5/50
									26	-	5/100	28	-	10/60	48	-	5/50
									27	-	3/60	29	-	10/60	49	-	5/50
									28	-	2/40	31	-	10/60	50	514	10/100
									29	-	2/40	32	-	10/60	51	-	5/50
									41	-	50/500	35	503	1/10	52	-	5/50
									43	-	50/500	40	504	10/60	55	-	10/100
									45	-	50/500	41	-	10/60	56	-	5/50
									46	-	25/250	42	-	10/60	57	-	5/50
									47	-	25/250	47	503	10/60	60	-	10/100
												48	-	5/50	61	-	5/50
												51	-	10/60	62	-	5/50
												52	-	10/60	65	-	10/100
												53	-	5/50	66	-	5/50
												57	-	5/50	67	-	5/50
												60	-	5/50	70	-	10/100
												61	-	5/50	71	-	5/50
												62	-	5/50	72	-	5/50
												63	-	5/50	75	-	10/100
												64	-	5/50	76	-	5/50
												65	-	5/50	77	-	5/50
												66	-	5/50	78	-	1/100
												68	-	5/50	79	-	1/50
												69	-	5/50	80	-	1/50
												70	-	10/60	82	-	1/100
												80	506	1/6	83	-	1/50
												81	-	1/30	84	-	1/50
												82	-	1/30	86	-	1/100
												83	-	1/30	87	-	1/50
												84	-	1/10	88	-	1/50
												85	-	1/30	90	-	1/100

**Bold pack quantities:** minimum quantities to be ordered. **Red catalogue number:** new products

Cat.Nos	Page N°	Pack	Cat.Nos	Page N°	Pack	Cat.Nos	Page N°	Pack	Cat.Nos	Page N°	Pack	Cat.Nos	Page N°	Pack	Cat.Nos	Page N°	Pack
2 819 91	514	1/50	2 831 63	510	5/50	2 833 35	510	1/10	2 835 10	511	5/50	3 690 00	584	1/6	4 018 73	196	1
92	-	1/50	64	-	5/50	40	511	5/50	11	-	5/50	03	-	1/6	74	-	1
97	-	10/300	65	-	5/50	41	-	5/50	12	-	5/30	05	-	1/10			
98	-	10/300	66	-	5/50	42	-	5/50	13	-	5/30	08	-	1/10	4 020 24	042	1/24
			68	-	5/50	47	510	5/50	14	-	5/50	70	583	1/3	25	-	1/24
2 830 00	507	5/50	69	-	5/50	48	-	5/50	15	-	5/30	73	-	1/3	26	-	1/24
01	-	5/50	70	-	5/50	51	-	5/50	20	512	5/50	75	-	1/6	27	-	1/24
02	-	5/50	80	513	1	52	-	5/50	26	-	5/50	78	-	1/6	28	-	1/24
03	-	5/50	82	-	1	53	-	5/50	27	511	5/50	80	-	1/6	29	-	1/24
04	-	5/50	83	-	1	57	-	5/50	28	-	5/50	83	-	1/6	30	-	1/24
05	-	5/50	84	-	1	60	-	5/50	29	-	5/50	85	-	1/8	32	-	1/24
06	-	5/50	85	-	1	61	-	5/50	31	-	5/50	88	-	1/8	33	-	1/24
07	-	5/50	90	514	10/100	62	-	5/50	32	-	5/50				34	-	1/24
08	-	4/40	91	-	5/50	63	-	5/50	35	510	1/10	3 691 00	582	1/6	36	-	1/24
09	-	4/40	92	-	5/50	64	-	5/50	40	511	5/50	05	-	1/8	37	-	1/24
10	-	5/50	93	-	5/50	65	-	5/50	41	-	5/50				38	-	1/24
11	-	5/50				66	-	5/50	42	-	5/50	3 692 00	582	1/6	62	-	1/12
12	-	5/50	2 832 00	507	5/50	68	-	5/50	47	510	5/50	05	-	1/8	63	-	1/12
13	-	5/50	01	-	5/50	69	-	5/50	48	-	5/50	10	-	1/6	64	-	1/12
14	-	5/50	02	-	5/50	70	-	5/50	51	-	5/50	15	-	1/8	66	-	1/12
15	-	5/50	03	-	5/50	80	513	1	52	-	5/50				67	-	1/12
16	-	5/50	04	-	5/50	82	-	1	53	-	5/50	3 693 00	582	1/6	68	-	1/12
17	-	5/50	05	-	5/50	83	-	1	57	-	5/50	05	-	1/6	70	-	1/12
40	509	5/50	06	-	5/50	84	-	1	60	-	5/50	10	-	1/6	71	-	1/12
41	-	5/50	07	-	5/50	85	-	1/30	61	-	5/50	15	-	1/6	72	-	1/12
45	513	5/50	08	-	4/40	90	514	10/100	62	-	5/50				74	-	1/12
46	-	5/50	09	-	4/40	91	-	5/50	63	-	5/50	3 866 21	269	50	75	-	1/12
48	-	1/30	10	-	5/50	92	-	5/50	64	-	5/50	22	-	50	76	-	1/12
50	508	5/50	11	-	5/50	93	-	5/50	65	-	5/50	23	-	50			
51	-	5/50	12	-	5/50				66	-	5/50	24	-	50	4 030 00	044	1/24
52	-	5/50	13	-	5/50	2 834 00	507	5/50	68	-	5/50	25	-	50	01	-	1/24
53	-	5/50	14	-	5/50	01	-	5/50	69	-	5/50	26	-	50	02	-	1/24
54	-	5/50	15	-	5/50	02	-	5/50	70	-	5/50	27	-	25	04	-	1
55	-	5/50	16	-	5/50	03	-	5/50	80	513	1	28	-	25	05	-	1
60	-	5/50	17	-	5/50	04	-	5/50	82	-	1	29	-	10	06	-	1
61	-	5/50	40	509	5/50	05	-	5/50	83	-	1	30	-	10	08	-	1/12
62	-	5/50	41	-	5/50	06	-	5/50	84	-	1	31	-	50	09	-	1/12
65	-	5/50	45	513	5/50	07	-	5/50	85	-	1	32	-	50	10	-	1/12
66	-	5/50	46	-	5/50	08	-	4/40	90	514	10/100	33	-	50	35	-	1
67	-	5/50	48	-	1/30	09	-	4/40	91	-	5/50	34	-	50	36	-	1
68	-	5/50	50	508	5/50	10	-	5/50	92	-	5/50	35	-	25	38	-	1/24
69	-	4/40	51	-	5/50	11	-	5/50	93	-	5/50	36	-	10	39	-	1/24
71	-	5/50	52	-	5/50	12	-	5/50				37	-	10	40	-	1/24
72	-	5/50	53	-	5/50	13	-	5/50							42	-	1/12
73	-	5/30	54	-	5/50	14	-	5/50				3 970 31	451	10/160	43	-	1/12
80	509	1/30	55	-	5/50	15	-	5/50				32	-	10/120	44	-	1/12
81	-	1/30	60	-	5/50	16	-	5/50	3 100 00	657	1/2	33	-	10/50			
82	-	1/30	61	-	5/50	17	-	5/50	01	-	1/2	41	-	10/160	4 033 50	045	10
84	-	1/30	62	-	5/50	40	509	5/50	02	-	1/2	42	-	10/120	53	-	10
85	-	1/20	65	-	5/50	41	-	5/50	03	-	1/2	43	-	10/50	55	-	10
90	-	1/30	66	-	5/50	45	513	5/50	04	-	1	51	-	10/160	56	-	10
91	-	1/30	67	-	5/50	46	-	5/50	05	-	1	52	-	10	57	-	10
92	-	1/30	68	-	5/50	48	-	1/30	06	658	1	53	-	10	58	-	10
97	513	5/50	69	-	4/40	50	508	5/50	07	-	1	54	-	10	59	-	10
			71	-	5/50	51	-	5/50	08	-	1	55	-	10/160	72	-	10/120
2 831 00	512	5/50	72	-	5/50	52	-	5/50	09	657	1/2	56	-	10	73	-	10/50
01	-	5/50	73	-	5/30	53	-	5/50	10	-	1/2	57	-	10	74	-	10/50
02	-	5/50	75	509	5/30	54	-	5/50	13	-	1	58	-	10/160	81	-	10/160
03	-	5/50	80	-	1/30	55	-	5/50	14	-	1	59	-	10/120	82	-	10/120
04	-	5/50	81	-	1/30	60	-	5/50	20	658	1	83	-	10/50	83	-	10
05	-	5/50	82	-	1/30	61	-	5/50	38	659	1	91	-	10/160	84	-	5
06	-	5/50	84	-	1/30	62	-	5/50	39	-	1	92	-	10/120	85	-	5
10	511	5/50	85	-	1/20	65	-	5/50	50	654	1	93	-	10/50	86	-	5
11	-	5/50	90	-	1/30	66	-	5/50	51	-	1	95	-	10	87	-	5
12	-	5/30	91	-	1/30	67	-	5/50	52	-	1	96	-	10	88	-	5
13	-	5/30	92	-	1/30	68	-	5/50	53	-	1	97	-	10	89	-	5
14	-	5/50	97	513	5/50	69	-	4/40	54	-	1				90	-	5
15	-	5/30				71	-	5/50	56	-	1				91	-	5
20	512	5/50	2 833 00	512	5/50	72	-	5/50	57	-	1				92	-	5
26	-	5/50	01	-	5/50	73	-	5/30	58	-	1				93	-	5
27	511	5/50	02	-	5/50	75	509	5/30	59	-	1				95	-	1
28	-	5/50	03	-	5/50	80	-	1/30				4 016 76	196	1	98	-	1
29	-	5/50	04	-	5/50	81	-	1/30	3 107 50	654	1	77	-	1			
31	-	5/50	05	-	5/50	82	-	1/30	51	-	1	78	-	1	4 034 00	045	1
32	-	5/50	06	-	5/50	84	-	1/30	52	-	1	79	-	1	01	-	1
35	510	1/10	10	511	5/50	85	-	1/20	53	-	1				02	-	1
40	511	5/50	11	-	5/50	90	-	1/30	54	-	1	4 018 44	196	2/20	03	-	1
41	-	5/50	12	-	5/30	91	-	1/30	66	-	1	45	-	2/20	04	-	1
42	-	5/50	13	-	5/30	92	-	1/30	69	-	1	50	-	5/20	05	-	1
47	510	5/50	14	-	5/50	97	513	5/50	70	-	1	51	-	2/50	06	-	1
48	-	5/50	15	-	5/30				71	-	1	53	-	2/40	07	-	1
51	-	5/50	20	512	5/50	2 835 00	512	5/50	72	-	1	55	-	2/12	08	-	1
52	-	5/50	26	-	5/50	01	-	5/50	3 109 50	654	1/6	56	-	1/20	10	-	1
53	-	5/50	27	511	5/50	02	-	5/50	52	-	1/4	57	-	1	13	-	1
57	-	5/50	28	-	5/50	03	-	5/50	53	-	1	61	-	1	15	-	1
60	-	5/50	29	-	5/50	04	-	5/50	54	-	1/2	62	-	1	16	-	1
61	-	5/50	31	-	5/50	05	-	5/50	69	-	1	63	-	1	17	-	1
62	-	5/50	32	-	5/50	06	-	5/50				64	-	1	18	-	1
									BT-348402	396	1	66	-	1	19	-	1
												71	-	1			
												72	-	1			

**Bold pack quantities:** minimum quantities to be ordered. **Red catalogue number:** new products

Cat.Nos	Page N°	Pack	Cat.Nos	Page N°	Pack	Cat.Nos	Page N°	Pack	Cat.Nos	Page N°	Pack	Cat.Nos	Page N°	Pack	Cat.Nos	Page N°	Pack
4 034 20	045	1	4 036 28	044	1/12	4 042 54	045	1	4 064 38	047	10/100	4 076 29	052	1/12	4 080 81	053	1/12
21	-	1	29	-	1/12	55	-	1	39	-	10/100	30	-	1/12	82	-	1/12
22	-	1	30	-	1/12	56	-	1	40	-	5/50	62	-	1/6	83	-	1/12
23	-	1	31	-	1/12	57	-	1	41	-	5/50	63	-	1/48	85	-	1/12
27	-	10	32	-	1/12	58	-	1	49	-	5/50	64	-	1/48	87	-	1/12
30	-	10				59	-	1	50	-	5/50	66	-	1/48	89	-	1/12
32	-	10	4 040 78	045	10	60	-	1	57	-	5/50	68	-	10/100	90	-	1/12
33	-	10	81	-	10	61	-	1	59	-	5/50	70	-	10/100	91	-	1/12
34	-	10	82	-	10	62	-	1	60	-	1/36	71	-	1/48	92	-	1/12
35	-	10	83	-	10				61	-	1/36	72	-	1/48	93	-	1/12
36	-	10	84	-	10	4 048 21	196	5/50	69	-	1/36	73	-	1/48	94	-	1/12
37	-	10	85	-	10				70	-	1/36	74	-	1/48	95	-	1/12
38	-	10	86	-	10	4 049 05	179	20/400	77	-	5/50	75	-	1/44			
39	-	10	87	-	10	06	-	20/400	79	-	5/50	76	-	1/44	4 081 43	053	1/12
40	-	10	88	-	10	11	-	20/200	80	-	1/30				45	-	1/12
			89	-	10	12	-	10	81	-	1/30	4 077 34	052	1/42	47	-	1/12
4 035 21	045	5	90	-	10	14	-	10	89	-	1/30	35	-	1/42	48	-	1/12
24	-	5	4 041 06	045	5	17	-	5/50	90	-	1/30	36	-	1/42	49	-	1/12
26	-	5	09	-	5	18	-	10	4 065 27	047	1/24	38	-	1/42	50	-	1/12
27	-	5	10	-	5	20	-	10	28	-	1/24	40	-	1/42	51	-	1/12
28	-	5	11	-	5	26	-	20/200	29	-	10/100	42	-	10/100	52	-	1/12
29	-	5	12	-	5	37	-	10	35	-	1/20	43	-	1/42	53	-	1/12
30	-	5	13	-	5	38	-	50	36	-	1/20	44	-	1/42			
31	-	5	14	-	5	39	-	10	38	-	1/5	45	-	1/42	4 085 99	054	1/6
32	-	5	15	-	5	40	-	3/30	39	-	1/5	46	-	1/42			
33	-	5	16	-	5	41	-	10	43	-	1/12	92	-	1/6	4 086 00	054	1/6
34	-	5	17	-	5	42	-	40	44	-	1/12	93	-	1/6	01	-	1/6
38	-	1	18	-	5	43	-	10	46	-	1/5	94	-	1/6	40	-	1/9
41	-	1	19	-	5	44	-	30	47	-	1/5	96	-	1/6	41	-	1/9
43	-	1	20	-	1	45	-	10				98	-	5/50	42	-	1/9
44	-	1	23	-	1	88	-	20/200	4 074 25	052	1/44				62	-	1/5
45	-	1	24	-	1	89	-	40/2000	26	-	1/44	4 078 00	052	5/50	63	-	1/5
46	-	1	25	-	1	90	-	20/840	27	-	1/44	01	-	1/6	64	-	1/5
47	-	1	26	-	1	91	-	20/840	29	-	1/44	02	-	1/6			
48	-	1	27	-	1				30	-	10/120	03	-	1/6	4 087 03	054	1/5
49	-	1	28	-	1	4 052 25	209	12	32	-	10/120	04	-	1/6	04	-	1/5
50	-	1	29	-	1	26	200	1/4	33	-	1/44	05	-	1/6	05	-	1/5
51	-	1	30	-	1				34	-	1/44	06	-	1/6	69	-	1/5
55	-	1	31	-	1	4 062 50	060	1/44	35	-	1/44	51	-	1/12	70	-	1/5
58	-	1	32	-	1	52	-	1/44	36	-	1/44	52	-	1/12	71	-	1/5
60	-	1	33	-	1	56	-	1	37	-	1/44	53	-	1/12			
61	-	1	34	-	1	58	-	1/44	38	-	1/44	55	-	1/12	4 088 65	054	1/44
62	-	1	35	-	1	60	-	1/44	68	-	1/42	57	-	1/12	66	-	1/44
63	-	1	36	-	1	62	-	1/44	69	-	1/42	59	-	1/12	67	-	1/44
64	-	1	37	-	1	64	-	1	70	-	1/42	60	-	1/12	68	-	1/44
65	-	1	38	-	1	66	-	1/44	72	-	1/42	61	-	1/12	69	-	1/44
66	-	1	39	-	1	76	-	1/44	73	-	1/42	62	-	1/12	70	-	1/44
67	-	1	40	-	1	78	-	1/44	75	-	10/100	63	-	1/12	71	-	1/44
68	-	1	41	-	1	80	-	1/44	76	-	1/42	64	-	1/12	72	-	1/44
74	044	10/100	42	-	1	82	-	1/44	77	-	1/42	65	-	1/12	73	-	1/44
75	-	10/100	43	-	1	85	-	1/44	78	-	1/42				74	-	1/44
76	-	10/100	44	-	1	86	-	1/33	79	-	1/42	4 079 20	052	1/12	75	-	1/44
77	-	10/100	45	-	1	87	-	1/6				21	-	1/12	76	-	1/44
78	-	10/100	46	-	10	88	061	1/4	4 075 02	052	1/6	22	-	1/12	77	-	1/44
79	-	10/100	47	-	10	89	-	1/4	03	-	1/6	24	-	1/12	78	-	1/44
80	-	10/100	48	-	10	90	-	1/4	04	-	1/6	26	-	1/12			
81	-	10/100	49	-	10	91	-	1/4	06	-	1/6	28	-	1/12	4 089 35	054	1/6
82	-	10/100	50	-	10	92	-	1	07	-	1/6	29	-	1/12	36	-	1/6
84	-	5/50	51	-	10	93	-	1/4	09	-	1/6	30	-	1/12	37	-	1/6
85	-	5/50	52	-	10	95	-	1/4	10	-	1/6	31	-	1/12	39	-	1/6
86	-	5/50	53	-	10				11	-	1/6	32	-	1/12	40	-	1/6
87	-	5/50	54	-	10	4 063 03	061	2/100	12	-	1/6	33	-	1/12	41	-	1
88	-	5/50	55	-	10	04	-	2/88	13	-	1/6	34	-	1/12	42	-	1/6
89	-	5/50	56	-	5	05	-	1/44	14	-	1/6	63	053	1/44	43	-	1/6
90	-	5/50	57	-	5	06	-	1/12	15	-	1/6	64	-	1/44	44	-	1/6
			4 042 01	045	5	07	-	10/200	54	-	1/12	65	-	1/44	45	-	1/6
4 036 04	044	5/50	03	-	5	10	-	1/24	55	-	1/12	67	-	1/44	46	-	1/6
05	-	5/50	04	-	5	11	-	1/24	56	-	1/12	69	-	1/44	47	-	1/6
06	-	5/50	05	-	5	12	-	1/10	58	-	1/12	71	-	1/44	48	-	1/6
07	-	5/50	06	-	5	13	-	3/126	59	-	1/12	72	-	1/44	84	-	1/12
08	-	5/50	07	-	5	14	-	1	61	-	1/12	73	-	1/44	85	-	1/12
09	-	5/50	08	-	5	15	-	1	62	-	1/12	74	-	1/44	86	-	1/12
10	-	5/50	09	-	5	16	-	1	63	-	1/12	75	-	1/44	88	-	1/12
11	-	5/50	10	-	5	19	-	1	64	-	1/12	76	-	1/44	89	-	1/12
12	-	5/50	11	-	5	20	-	1	65	-	1/12	77	-	1/44	90	-	1/12
14	-	1/20	15	-	1				66	-	1/12				91	-	1/12
15	-	1/20	18	-	1	4 064 00	047	10/100	67	-	1/12	4 080 23	053	1/6	92	-	1/12
16	-	1/20	20	-	1	01	-	10/100				24	-	1/6	93	-	1/12
17	-	1/20	21	-	1	03	-	10/100	4 076 17	052	1/12	25	-	1/6	94	-	1/12
18	-	1/20	22	-	1	04	-	10/100	18	-	1/12	27	-	1/6	95	-	1/12
19	-	1/20	23	-	1	06	-	10/100	19	-	1/12	29	-	1/6	96	-	1/12
20	-	1/20	24	-	1	11	-	10/100	21	-	1/12	31	-	1/6	97	-	1/12
21	-	1/20	25	-	1	12	-	10/100	22	-	1/12	32	-	1/6			
22	-	1/20	26	-	1	23	-	10/100	24	-	1/12	33	-	1/6	4 090 58	054	1/12
24	-	1/12	27	-	1	31	-	10/100	25	-	1/12	34	-	1/6	59	-	1/12
25	-	1/12	28	-	1	32	-	10/100	26	-	1/12	35	-	1/6	60	-	1/12
26	-	1/12	49	-	1	34	-	10/100	27	-	1/12	36	-	1/6	62	-	1/12
27	-	1/12	52	-	1	36	-	10/100	28	-	1/12	37	-	1/6	63	-	1/12

**Bold pack quantities:** minimum quantities to be ordered. **Red catalogue number:** new products



Cat.Nos	Page N°	Pack	Cat.Nos	Page N°	Pack	Cat.Nos	Page N°	Pack	Cat.Nos	Page N°	Pack	Cat.Nos	Page N°	Pack	Cat.Nos	Page N°	Pack
4 090 64	054	1/12	4 097 59	056	1/6	4 098 51	056	1/5	4 104 86	058	1/8	4 111 85	051	1/12	4 117 02	048	1/12
65	-	1/12	60	-	1/6	52	-	1/5	99	-	1/8	86	-	1/12	03	-	1/12
66	-	1/12	61	-	1/6	53	-	1/5				87	-	1/12	04	-	1/12
67	-	1/12	62	-	1/6	54	-	1/5	4 105 00	058	1/8	88	-	1/12	05	-	1/12
68	-	1/12	63	-	1/6	55	-	1/5	11	-	1/8	89	-	1/12	07	046	1
69	-	1/12	64	-	1/6				12	-	1/8	90	-	1/12	08	-	1
70	-	1/12	65	-	1/6	4 101 34	057	1/6	21	-	1/8	91	-	1/12	09	-	1
71	-	1/12	66	-	1/6	35	-	1/6	23	-	1/8	92	-	1/12	10	-	1
			67	-	1/6	36	-	1/6	25	-	1/8				12	048	1/12
4 091 07	054	1/44	68	-	1/6	37	-	1/6	26	-	1/8	4 112 04	051	1/12	13	-	1/12
08	-	1/44	69	-	1/6	38	-	1/6	28	-	1/8	05	-	1/12	14	-	1/12
09	-	1/44	70	-	1/6	39	-	1/6	29	-	1/8	06	-	1/12	15	-	1/12
11	-	1/44	71	-	1/6	40	-	1/6	31	-	1/8	07	-	1/12	17	046	1
12	-	10/120	72	-	1/9	41	-	1/6	34	-	1/8	08	-	1/12	18	-	1
13	-	1/44	73	-	1/9	47	-	1/9	55	-	1/8	09	-	1/12	19	-	1
14	-	10/120	74	-	1/9	48	-	1/9	68	059	1/6	10	-	1/12	20	-	1
15	-	1/44	75	-	1/9	49	-	1/9	71	-	1/6	11	-	1/12	22	048	1/12
16	-	1/44	76	-	1/9	50	-	1/9	76	-	1/9	33	-	1/12	23	-	1/12
17	-	1/44	77	-	1/9	51	-	1/9	78	-	1/6	34	-	1/12	24	-	1/12
18	-	1/44	78	-	1/12	52	-	1/9	82	-	1	35	-	1/12	25	-	1/12
19	-	1/44	79	-	1/12	53	-	1/9	83	-	1/6	36	-	1/12	27	046	1
20	-	1/44	80	-	1/12	54	-	1/9				37	-	1/12	28	-	1
95	-	1/6	81	-	1/12	60	-	1/5	4 106 05	059	1/5	38	-	1/12	29	-	1
96	-	1/6	82	-	1/12	61	-	1/5	08	-	1/5	39	-	1/12	30	-	1
97	-	1/6	83	-	1/12	62	-	1/5	11	-	1/4	40	-	1/12	32	048	1/12
99	-	1/6	84	-	1/5	63	-	1/5	25	-	1/4	41	-	1/12	33	-	1/12
			85	-	1/5	64	-	1/5	29	-	1/4	42	-	1/12	34	-	1/12
4 092 00	054	1/6	86	-	1/5	65	-	1/5	36	-	1/5	44	-	1/12	35	-	1/12
01	-	1/6	87	-	1/5	66	-	1/5	38	-	1	45	-	1/12	45	-	1/12
02	-	1/6	88	-	1/5	67	-	1/5	40	-	1/5	46	-	1/12	46	-	1/12
03	-	1/6	89	-	1/5	73	-	1/5	42	-	1/4	47	-	1/12	59	-	1/12
04	-	1/6	90	-	1/5	74	-	1/5	43	-	1/4				60	-	1/12
05	-	1/6	91	-	1/12	75	-	1/5	57	-	1/4				61	-	1/12
06	-	1/6	92	-	1/12	76	-	1/5	58	-	1/4	4 115 00	048	1/24	62	-	1/12
07	-	1/6	93	-	1/12	77	-	1/5	59	-	1/4	02	046	1	63	-	1/12
08	-	1/6	94	-	1/12	78	-	1/5				04	048	1/24	64	046	1
47	-	1/12	95	-	1/12	79	-	1/5				05	-	1/24	65	-	1
48	-	1/12	96	-	1/12	80	-	1/5	4 109 93	050	1/24	06	-	1/24	66	-	1
49	-	1/12	97	-	1/5	86	-	1/6	97	-	1/24	07	-	1/24	67	-	1
51	-	1/12	98	-	1/5	87	-	1/6	99	-	1/24	08	-	1/24	69	048	1/12
52	-	1/12	99	-	1/5	88	-	1/6				09	046	1	70	-	1/12
53	-	1/12				89	-	1/6	4 110 00	050	1/24	10	-	1	71	-	1/12
54	-	1/12	4 098 00	056	1/5	90	-	1/6	02	-	1/24	11	-	1	72	-	1/12
55	-	1/12	01	-	1/5	91	-	1/6	03	-	1/24	12	-	1	73	-	1/12
56	-	1/12	02	-	1/5	92	-	1/6	04	-	1/24	14	048	1/24	74	046	1
57	-	1/12	03	-	1/5	93	-	1/6	05	-	1/24	15	-	1/24	75	-	1
58	-	1/12	04	-	1/44	99	-	1/9	06	-	1/24	16	-	1/24	76	-	1
59	-	1/12	05	-	1/44				21	-	1/24	17	-	1/24	77	-	1
60	-	1/12	06	-	1/44	4 102 00	057	1/9	22	-	1/24	19	046	1	79	048	1/12
			07	-	1/6	01	-	1/9	24	-	1/24	20	-	1	80	-	1/12
4 093 29	054	1/12	08	-	1/6	02	-	1/9	25	-	1/24	21	-	1	81	-	1/12
30	-	1/12	09	-	1/6	03	-	1/9	26	-	1/24	22	-	1	82	-	1/12
31	-	1/12	10	-	1/6	04	-	1/9	27	-	1/24	24	048	1/24	83	-	1/12
33	-	1/12	11	-	1/6	12	-	1/5	28	-	1/24	25	-	1/24	84	046	1
34	-	1/12	12	-	1/6	13	-	1/5	41	-	1/24	26	-	1/24	85	-	1
35	-	1/12	13	-	1/6	14	-	1/5	47	-	1/24	27	-	1/24	86	-	1
36	-	1/12	14	-	1/6	15	-	1/5	48	-	1/24	28	-	1/24	87	-	1
37	-	1/12	15	-	1/6	16	-	1/5	50	-	1/24	29	046	1	89	048	1/12
38	-	1/12	16	-	1/6	17	-	1/5	51	-	1/24	30	-	1	90	-	1/12
39	-	1/12	17	-	1/6	18	-	1/5	52	-	1/24	31	-	1	91	-	1/12
40	-	1/12	18	-	1/6	19	-	1/5	53	-	1/24	32	-	1	92	-	1/12
41	-	1/12	19	-	1/6	25	-	1/5	54	-	1/24	37	048	1/24	93	-	1/12
42	-	1/12	20	-	1/6	26	-	1/5	91	-	1/24	43	-	1/24			
			21	-	1/6	27	-	1/5	92	-	1/24	50	-	1/24			
4 095 59	055	1/6	22	-	1/6	28	-	1/5	95	-	1/24	52	046	1	4 118 00	048	1/12
60	-	1/6	23	-	1/9	29	-	1/5	96	-	1/24	54	048	1/24	01	-	1/12
61	-	1/6	24	-	1/9	30	-	1/5	97	-	1/24	55	-	1/24	42	-	1/12
62	-	1/6	30	-	1/12	31	-	1/5	98	-	1/24	56	-	1/24	43	-	1/12
63	-	1/6	31	-	1/12	32	-	1/5				57	-	1/24	44	-	1/12
64	-	1/6	32	-	1/12				4 111 49	051	1/18	59	046	1	45	-	1/12
65	-	1/6	33	-	1/5	4 104 01	058	1/12	50	-	1/18	60	-	1	46	-	1/12
66	-	1/6	34	-	1/5	02	-	1/12	51	-	1/18	61	-	1	47	-	1/12
67	-	1/6	35	-	1/5	13	-	1/12	57	-	1/18	62	-	1	48	-	1/12
68	-	1/6	36	-	1/5	14	-	1/12	58	-	1/18	64	-	1	49	-	1/12
69	-	1/6	37	-	1/5	24	-	1/12	59	-	1/18	65	-	1			
70	-	1/6	38	-	1/5	26	-	1/12	60	-	1/18	66	-	1	4 120 00	084	1/10
71	-	1/6	39	-	1/5	28	-	1/12	61	-	1/18	67	-	1	02	-	1/50
72	-	1/6	40	-	1/5	29	-	1/12	62	-	1/18						
73	-	1/6	41	-	1/5	31	-	1/12	63	-	1/18	69	048	1/24	4 124 00	068	1/100
74	-	1/6	42	-	1/5	32	-	1/12	64	-	1/18	70	-	1/24	01	-	1/100
			43	-	1/12	35	-	1/12	71	-	1/18	71	-	1/24	04	-	1/42
4 097 52	056	1/44	44	-	1/12	71	-	1/8	72	-	1/18	72	-	1/24	05	-	1/42
53	-	1/44	45	-	1/12	72	-	1/8	73	-	1/18	74	046	1	08	-	10/100
54	-	1/44	46	-	1/5	74	-	1/8	75	-	1/18	75	-	1	10	-	1/42
55	-	1/44	47	-	1/5	75	-	1/8	76	-	1/18	76	-	1	11	-	1/42
56	-	1/44	48	-	1/5	77	-	1/8	77	-	1/18	77	-	1	12	-	10/100
57	-	1/44	49	-	1/5	80	-	1/8	78	-	1/18	90	048	1/24	14	-	1/24
58	-	1/6	50	-	1/5	83	-	1/8				91	-	1/24	16	-	1/24
												92	-	1/24	29	-	1/42

**Bold pack quantities:** minimum quantities to be ordered. **Red catalogue number:** new products

Cat.Nos	Page N°	Pack	Cat.Nos	Page N°	Pack	Cat.Nos	Page N°	Pack	Cat.Nos	Page N°	Pack	Cat.Nos	Page N°	Pack	Cat.Nos	Page N°	Pack
4 124 30	071	1/42	4 130 65	432	1	4 161 34	170	1	4 163 59	171	1	4 167 46	172	1	4 168 95	174	1
31	-	1/42	66	-	1	36	-	1	47	-	1	47	-	1	96	-	1
33	068	1/42	67	-	1	39	-	1	48	-	1	48	-	1	97	-	1
34	-	1/42	68	-	1	40	-	1	4 164 26	173	1	49	-	1	98	-	1
36	-	1/42	69	-	1	41	-	1	36	-	1	50	-	1			
37	-	1/42	70	-	1	44	-	1	46	-	1	51	-	1			
39	-	1/42	71	-	1/20	46	-	1	56	-	1	60	-	1	4 173 00	164	1
			72	433	1	49	-	1	66	-	1	61	-	1	01	-	1
4 125 03	071	1/42	73	-	1	50	-	1	76	-	1	62	-	1	02	-	1
05	-	1/42	74	-	1/10	51	-	1	86	-	1	63	-	1	03	-	1
09	-	1/24	75	432	1	54	-	1	96	-	1	64	-	1	04	-	1
10	-	1/24	91	080	1/27	56	-	1	4 165 06	173	1	65	-	1	05	-	1
14	070	1/42	92	-	1/15	59	-	1	16	-	1	70	-	1	06	-	1
15	-	1/24	93	-	1/15	60	-	1	26	-	1	71	-	1	07	-	1
16	-	1/24	96	-	1/15	61	-	1	91	172	1	72	-	1	08	-	1
17	-	1/24	98	-	1/10	64	-	1	92	-	1	73	-	1	09	-	1
18	-	1/20				66	-	1	93	-	1	74	-	1	10	-	1
19	-	1/20	4 131 05	081	1/10	69	-	1	94	-	1	75	-	1	11	-	1
21	071	4/48	06	-	1/10	70	-	1	95	-	1	80	173	1	12	-	1
23	-	10/100	07	-	1/10	71	-	1	96	-	1	81	-	1	13	-	1
24	-	1/42	08	-	1/10	74	-	1	97	-	1	82	-	1	14	-	1
27	-	1/24				76	-	1	98	-	1	83	-	1	15	-	1
33	-	1/24	4 132 05	425	1/10	79	-	1				84	-	1	20	-	1
35	-	5/50				80	-	1	4 166 40	172	1	86	-	1	21	-	1
36	-	1/24	4 151 60	094	1/12	81	-	1	41	-	1	87	-	1	22	-	1
41	-	1/20	61	-	1/12	84	-	1	42	-	1	88	-	1	23	-	1
44	070	4/48	62	-	1/6	86	-	1	43	-	1/6	89	-	1	24	-	1
45	-	1/24	63	-	1/6	89	-	1	44	-	1	90	-	1	25	-	1
47	-	1/24	64	-	1/6	90	-	1	45	-	1	91	-	1	26	-	1
48	-	1/24	65	-	1/4	91	-	1	46	-	1/4	92	-	1	27	-	1
49	-	1/20	66	-	1/4	94	-	1	47	-	1	93	-	1	28	-	1
50	-	1/20	67	-	1/4	96	-	1	48	-	1	94	-	1	29	-	1
51	-	2/24	68	-	1/4	99	-	1	49	-	1	95	-	1	30	-	1
53	-	1/20	69	-	1/12				50	-	1				31	-	1
56	-	1/20	70	-	1/12	4 162 00	170	1	51	-	1	4 168 00	175	1	32	-	1
57	-	1/20	71	-	1/6	01	-	1	52	-	1	01	-	1	33	-	1
58	-	1/42	72	-	1/6	04	-	1	53	-	1	04	-	1	34	-	1
59	-	1/24	73	-	1/6	06	-	1	54	-	1	06	-	1	35	-	1
60	-	1/24	74	-	1/4	09	-	1	55	-	1	09	-	1	40	-	1
61	-	1/24	75	-	1/4	10	-	1	56	-	1/4	10	-	1	41	-	1
62	-	1/20	76	-	1/4	11	-	1	57	-	1	11	-	1	42	-	1
63	-	1/20	77	-	1/4	14	-	1	60	-	1	14	-	1	43	-	1
			78	-	1/12	16	-	1	61	-	1	16	-	1	44	-	1
4 126 02	077	10/100	79	-	1/12	19	-	1	62	-	1	19	-	1	45	-	1
23	078	1/40	80	-	1/6	20	-	1	63	-	1	20	-	1	46	-	1
26	-	1/12	81	-	1/6	21	-	1	64	-	1	21	-	1	47	-	1
30	074	1/30	82	-	1/6	24	-	1	65	-	1	24	-	1	48	-	1
31	-	1/30	83	-	1/4	26	-	1	66	-	1	26	-	1	49	-	1
33	-	1/30	84	-	1/4	29	-	1	67	-	1	29	-	1	50	-	1
41	-	1/30	85	-	1/4	30	-	1	68	-	1	40	174	1	51	-	1
54	-	1/30	86	-	1/4	31	-	1	69	-	1	41	-	1	52	-	1
57	-	1/30	87	-	1/4	34	-	1	70	-	1	42	-	1	53	-	1
			88	-	1/6	36	-	1	71	-	1	43	-	1	54	-	1
4 127 80	075	1/100	89	-	1/4	39	-	1	72	-	1	44	-	1	55	-	1
90	-	1/100	90	-	1/4	40	171	1	73	-	1	45	-	1	60	-	1
94	-	1/100	91	-	1/4	41	-	1	74	-	1/4	46	-	1	61	-	1
95	-	1/30	92	-	1/4	46	-	1	75	-	1	47	-	1	62	-	1
			93	-	1/4	49	-	1	76	-	1	49	-	1	63	-	1
4 128 12	075	1/30	94	-	1/4	50	-	1	77	-	1	50	-	1	64	-	1
13	-	1/30				51	-	1	83	-	1	51	-	1	65	-	1
58	078	1/40	4 160 80	170	1	56	-	1	84	-	1	52	-	1	66	-	1
72	074	10/100	81	-	1	59	-	1	85	-	1	53	-	1	67	-	1
73	-	1/30	84	-	1	60	-	1	86	-	1	54	-	1	68	-	1
			86	-	1	61	-	1	87	-	1	55	-	1	70	-	1
4 130 01	425	4/40	89	-	1	66	-	1	88	-	1	56	-	1	71	-	1
03	429	4/40	90	-	1	69	-	1	89	-	1	57	-	1	72	-	1
09	425	1/10	91	-	1	70	-	1	90	-	1	58	-	1	73	-	1
10	-	1/10	94	-	1	71	-	1				59	-	1	74	-	1
12	-	1/10	96	-	1	76	-	1	4 167 03	172	1	70	-	1	75	-	1
13	-	1/10	99	-	1	79	-	1	04	-	1	71	-	1	76	-	1
15	-	1/10				80	-	1	05	-	1	72	-	1	77	-	1
17	-	1/10	4 161 00	170	1	86	-	1	06	-	1	73	-	1	78	-	1
18	429	1/10	01	-	1	89	-	1	07	-	1	74	-	1	79	-	1
19	-	1/10	04	-	1	90	-	1	08	-	1	75	-	1			
40	-	1/5	06	-	1	96	-	1	09	-	1	79	-	1	4 174 00	165	1
44	-	1/10	09	-	1	99	-	1	10	-	1	80	-	1	01	-	1
45	-	4/40	10	-	1				23	-	1	82	-	1	02	-	1
46	-	4/40	11	-	1	4 163 06	171	1	24	-	1	83	-	1	03	-	1
47	425	4/40	14	-	1	09	-	1	25	-	1	84	-	1	04	-	1
48	-	4/40	16	-	1	16	-	1	26	-	1	85	-	1	05	-	1
49	-	1/5	19	-	1	19	-	1	27	-	1	87	-	1	06	-	1
50	433	1/10	20	-	1	26	-	1	28	-	1	88	-	1	07	-	1
51	-	1/10	21	-	1	29	-	1	29	-	1	89	-	1	10	-	1
60	432	1	24	-	1	36	-	1	30	-	1	90	-	1	11	-	1
61	-	1	26	-	1	39	-	1	31	-	1	91	-	1	12	-	1
62	-	1/10	29	-	1	46	-	1	43	-	1	92	173	1	13	-	1
63	-	1	30	-	1	49	-	1	44	-	1	93	-	1	20	-	1
64	-	1	31	-	1	56	-	1	45	-	1	94	-	1	21	-	1

**Bold pack quantities:** minimum quantities to be ordered. **Red catalogue number:** new products

Cat.Nos	Page N°	Pack	Cat.Nos	Page N°	Pack	Cat.Nos	Page N°	Pack	Cat.Nos	Page N°	Pack	Cat.Nos	Page N°	Pack	Cat.Nos	Page N°	Pack
4 174 22	165	1	4 192 34	041	4	4 200 03	120	1	4 201 52	120	1	4 204 02	124	1	4 206 68	124	1
23	-	1	35	-	4	04	-	1	53	-	1	05	-	1	69	-	1
30	-	1	36	-	4	05	-	1	54	-	1	07	-	1	75	-	1
31	-	1	37	-	4	06	-	1	55	-	1	09	-	1	77	-	1
32	-	1	38	-	4	07	-	1	56	-	1	12	-	1	78	-	1
33	-	1	39	-	4	10	-	1	57	-	1	15	-	1	79	-	1
48	-	1	40	-	4	11	-	1	97	151	1	17	-	1	85	-	1
49	-	1	41	-	4	12	-	1	98	-	1	19	-	1	87	-	1
50	-	1				13	-	1	99	-	1	22	-	1	88	-	1
51	-	1	4 196 61	040	12	14	-	1				25	-	1	89	-	1
52	-	1	62	-	12	15	-	1	4 202 05	122	1	27	-	1	92	125	1
53	-	1	64	-	12	16	-	1	07	-	1	29	-	1	95	-	1
54	-	1	65	-	12	17	-	1	08	-	1	32	-	1	97	-	1
55	-	1	66	-	12	30	-	1	09	-	1	35	-	1	99	-	1
56	-	1	67	-	12	31	-	1	15	-	1	37	-	1			
57	-	1	68	-	12	32	-	1	17	-	1	39	-	1	4 207 02	125	1
58	-	1	69	-	12	33	-	1	18	-	1	42	-	1	05	-	1
59	-	1	70	-	12	34	-	1	19	-	1	45	-	1	07	-	1
60	-	1	94	-	6	35	-	1	25	-	1	47	-	1	09	-	1
61	-	1	95	-	6	36	-	1	27	-	1	49	-	1			
62	-	1	97	-	6	37	-	1	28	-	1	52	-	1	4 210 00	126	1/5
63	-	1	98	-	6	40	-	1	29	-	1	55	-	1	01	-	1/5
64	-	1	99	-	6	41	-	1	35	-	1	57	-	1	02	-	1/5
65	-	1				42	-	1	37	-	1	59	-	1	03	-	1/5
71	-	1	4 197 00	040	6	43	-	1	38	-	1	62	-	1	04	-	1
72	-	1	01	-	6	44	-	1	39	-	1	65	-	1	05	-	1
73	-	1	02	-	6	45	-	1	45	-	1	67	-	1	06	-	1/12
74	-	1	03	-	6	46	-	1	47	-	1	69	-	1	07	-	1/12
75	-	1	05	-	4	47	-	1	48	-	1	72	-	1	08	-	1/3
76	-	1	06	-	4	50	-	1	49	-	1	75	-	1	09	-	1/3
77	-	1	08	-	4	51	-	1	55	-	1	77	-	1	10	-	1/12
79	-	1	09	-	4	52	-	1	57	-	1	79	-	1	11	-	1/12
80	-	1	10	-	4	53	-	1	58	-	1	82	-	1	12	-	1/12
81	-	1	11	-	4	54	-	1	59	-	1	85	-	1	13	-	1/12
			12	-	4	55	-	1	65	-	1	87	-	1	14	-	1/12
4 191 33	041	12	13	-	4	56	-	1	67	-	1	89	-	1	15	-	1/12
34	-	12	14	-	4	57	-	1	68	-	1				16	-	1/12
35	-	12	38	-	3	70	-	1	69	-	1	4 205 02	125	1	17	-	1/12
36	-	12	39	-	3	71	-	1	75	-	1	05	-	1	18	-	1/12
37	-	12	41	-	3	72	-	1	77	-	1	07	-	1	19	-	1/12
38	-	12	42	-	3	73	-	1	78	-	1	09	-	1	20	-	1/12
39	-	12	43	-	3	74	-	1	79	-	1	12	-	1	21	-	1/12
40	-	12	44	-	3	75	-	1	85	-	1	15	-	1	22	-	1/12
41	-	12	45	-	3	76	-	1	87	-	1	17	-	1	23	-	1/12
42	-	12	46	-	3	77	-	1	88	-	1	19	-	1	24	-	1/12
55	-	6	47	-	3	80	-	1	89	-	1	22	-	1	25	-	1/12
56	-	6				81	-	1	98	151	1	25	-	1	26	121	1/2
57	-	6	4 198 37	040	12	82	-	1	99	-	1	27	-	1	27	-	1/2
58	-	6	38	-	12	83	-	1				29	-	1	28	-	1/12
59	-	6	40	-	12	84	-	1	4 203 00	151	1	32	-	1	29	-	1/12
60	-	6	41	-	12	85	-	1	02	123	1	35	-	1	30	125	1/8
61	-	6	42	-	12	86	-	1	05	-	1	37	-	1	31	-	1/8
62	-	6	43	-	12	87	-	1	07	-	1	39	-	1	32	121	1/8
63	-	6	44	-	12	90	-	1	09	-	1	42	-	1	33	-	1/8
64	-	6	45	-	12	91	-	1	12	-	1	45	-	1	34	125	1/8
66	-	4	46	-	12	92	-	1	15	-	1	47	-	1	35	-	1/8
67	-	4	70	-	6	93	-	1	17	-	1	49	-	1	36	121	1/6
68	-	4	71	-	6	94	-	1	19	-	1	52	-	1	37	-	1/6
69	-	4	73	-	6	95	-	1	22	-	1	55	-	1	38	125	1/6
70	-	4	74	-	6	96	-	1	25	-	1	57	-	1	39	-	1/6
71	-	4	75	-	6	97	-	1	27	-	1	59	-	1	40	121	1
72	-	4	76	-	6				29	-	1				41	-	1
73	-	4	77	-	6	4 201 10	120	1	32	-	1	4 206 05	122	1	42	125	1
74	-	4	78	-	6	11	-	1	35	-	1	07	-	1	43	-	1
75	-	4	79	-	6	12	-	1	37	-	1	08	-	1	44	121	1/5
99	-	12	81	-	4	13	-	1	39	-	1	09	-	1	45	-	1/10
			82	-	4	14	-	1	42	-	1	15	-	1	46	-	1/10
4 192 00	041	12	84	-	4	15	-	1	44	-	1	17	-	1	47	-	1/10
01	-	12	85	-	4	16	-	1	47	-	1	18	-	1	48	126	1/8
02	-	12	86	-	4	17	-	1	49	-	1	19	-	1	49	-	1/12
03	-	12	87	-	4	20	-	1	52	-	1	25	-	1	50	121	1/4
04	-	12	88	-	4	21	-	1	55	-	1	27	-	1	51	-	1/5
05	-	12	89	-	4	22	-	1	57	-	1	28	-	1	52	125	1/5
06	-	12	90	-	4	23	-	1	59	-	1	29	-	1	53	-	1/3
07	-	12				24	-	1	62	-	1	35	123	1	54	121	1/4
08	-	12	4 199 14	040	3	25	-	1	65	-	1	37	-	1	55	-	1/5
21	-	6	15	-	3	26	-	1	67	-	1	38	-	1	56	125	1/5
22	-	6	17	-	3	27	-	1	69	-	1	39	-	1	57	-	1/3
23	-	6	18	-	3	30	-	1	72	-	1	45	-	1	58	126	1
24	-	6	19	-	3	31	-	1	75	-	1	47	-	1	59	-	1/2
25	-	6	20	-	3	32	-	1	77	-	1	48	-	1	60	-	1
26	-	6	21	-	3	33	-	1	79	-	1	49	-	1	61	-	1/4
27	-	6	22	-	3	34	-	1	82	-	1	55	-	1	62	-	1/12
28	-	6	23	-	3	35	-	1	85	-	1	57	-	1	63	-	1/12
29	-	6				36	-	1	87	-	1	58	-	1	64	-	1/12
30	-	6	4 200 00	120	1	37	-	1	89	-	1	59	-	1	65	-	1/12
32	-	4	01	-	1	50	-	1				65	124	1	66	-	1/12
33	-	4	02	-	1	51	-	1				67	-	1	67	-	1/12

**Bold pack quantities:** minimum quantities to be ordered. **Red catalogue number:** new products

Cat.Nos	Page N°	Pack	Cat.Nos	Page N°	Pack	Cat.Nos	Page N°	Pack	Cat.Nos	Page N°	Pack	Cat.Nos	Page N°	Pack	Cat.Nos	Page N°	Pack
4 210 68	121	1/8	4 220 74	130	1	4 221 61	131	1	4 222 52	134	1	4 223 59	135	1	4 224 69	136	1
69	125	1/8	75	-	1	62	-	1	53	-	1	60	-	1	70	-	1
70	121	1/2	76	-	1	63	-	1	54	-	1	61	-	1	71	-	1
71	-	1/5	77	-	1	64	-	1	56	-	1	62	-	1	73	-	1
72	125	1/16	78	-	1	65	-	1	57	-	1	63	-	1	74	-	1
73	121	1/5	79	-	1	66	-	1	58	-	1	65	-	1	75	-	1
74	125	1/16	80	-	1	67	-	1	59	-	1	66	-	1	76	-	1
75	126	1/6	81	-	1	68	-	1	60	-	1	67	-	1	77	-	1
79	125	1/12	82	-	1	69	-	1	61	-	1	68	-	1	79	-	1
80	-	1/12	83	-	1	70	-	1	63	-	1	69	-	1	80	-	1
83	138	1/3	84	-	1	71	-	1	64	-	1	71	-	1	81	-	1
93	121	1	85	-	1	72	-	1	65	-	1	72	-	1	82	-	1
94	-	1/12	86	-	1	73	-	1	66	-	1	73	-	1	85	-	1
4 220 00	128	1	87	-	1	74	-	1	68	-	1	74	-	1	86	-	1
01	-	1	88	-	1	75	-	1	69	-	1	75	-	1	87	-	1
02	-	1	89	-	1	76	-	1	70	-	1	77	-	1	88	-	1
03	-	1	90	-	1	77	-	1	71	-	1	78	-	1	90	151	1
04	-	1	91	-	1	78	-	1	72	-	1	79	-	1	91	-	1
05	-	1	92	-	1	79	-	1	73	-	1	80	-	1	92	-	1
06	-	1	93	-	1	80	-	1	75	-	1	81	-	1	93	-	1
07	-	1	94	-	1	81	-	1	76	-	1	83	-	1	94	-	1
08	-	1	95	-	1	82	-	1	77	-	1	84	-	1	95	-	1
09	-	1	96	-	1	83	-	1	78	-	1	85	-	1	96	-	1
10	-	1	97	-	1	84	-	1	80	-	1	86	-	1	97	-	1
11	-	1	98	-	1	85	-	1	81	-	1	89	-	1	98	129	1
12	-	1	99	-	1	86	-	1	82	-	1	90	-	1	99	-	1
13	-	1	4 221 00	130	1	87	-	1	83	-	1	91	-	1	4 225 00	129	1
14	-	1	01	-	1	88	-	1	84	-	1	92	-	1	01	-	1
15	-	1	02	-	1	89	-	1	85	-	1	95	136	1	02	-	1
16	-	1	03	-	1	90	-	1	87	-	1	96	-	1	03	-	1
17	-	1	04	-	1	91	-	1	88	-	1	97	-	1	04	-	1
18	-	1	05	-	1	92	-	1	89	-	1	98	-	1	05	-	1
19	-	1	06	-	1	93	-	1	90	-	1	4 224 01	136	1	06	-	1
20	-	1	07	-	1	94	-	1	92	-	1	02	-	1	07	-	1
21	-	1	08	-	1	95	-	1	93	-	1	03	-	1	08	-	1
22	-	1	09	-	1	96	-	1	94	-	1	04	-	1	09	-	1
23	-	1	10	-	1	97	-	1	95	-	1	05	-	1	10	-	1
24	-	1	11	-	1	98	-	1	96	-	1	07	-	1	11	-	1
25	-	1	12	-	1	99	-	1	97	-	1	08	-	1	12	-	1
26	-	1	13	-	1	4 222 00	131	1	99	135	1	09	-	1	13	-	1
27	-	1	14	-	1	01	-	1	4 223 00	135	1	10	-	1	14	-	1
28	-	1	15	-	1	02	-	1	01	-	1	11	-	1	15	-	1
29	-	1	16	-	1	03	-	1	02	-	1	13	-	1	16	-	1
30	-	1	17	-	1	04	-	1	03	-	1	14	-	1	17	-	1
31	-	1	18	-	1	05	-	1	05	-	1	15	-	1	18	-	1
32	-	1	19	-	1	06	-	1	06	-	1	16	-	1	19	-	1
33	-	1	20	-	1	07	-	1	07	-	1	17	-	1	20	-	1
34	-	1	21	-	1	08	-	1	08	-	1	19	-	1	21	-	1
35	-	1	22	-	1	09	-	1	09	-	1	20	-	1	22	-	1
36	-	1	23	-	1	10	-	1	11	-	1	21	-	1	23	-	1
37	-	1	24	-	1	11	-	1	12	-	1	22	-	1	24	-	1
38	-	1	25	-	1	12	-	1	13	-	1	23	-	1	25	-	1
39	-	1	26	-	1	13	-	1	14	-	1	25	-	1	26	-	1
40	-	1	27	-	1	14	-	1	15	-	1	26	-	1	27	-	1
41	-	1	28	-	1	15	-	1	17	-	1	27	-	1	28	-	1
42	-	1	29	-	1	16	151	1	18	-	1	28	-	1	29	-	1
43	-	1	30	-	1	17	-	1	19	-	1	29	-	1	30	-	1
44	-	1	31	-	1	18	-	1	20	-	1	31	-	1	31	-	1
45	-	1	32	-	1	19	-	1	21	-	1	32	-	1	32	-	1
46	-	1	33	-	1	20	132	1	23	-	1	33	-	1	33	-	1
47	-	1	34	-	1	21	-	1	24	-	1	34	-	1	34	-	1
48	-	1	35	-	1	22	-	1	25	-	1	37	-	1	35	-	1
49	-	1	36	131	1	23	-	1	26	-	1	38	-	1	36	-	1
50	-	1	37	-	1	24	-	1	27	-	1	39	-	1	37	-	1
51	-	1	38	-	1	25	-	1	29	-	1	40	-	1	39	134	1
52	-	1	39	-	1	26	-	1	30	-	1	43	-	1	40	-	1
53	-	1	40	-	1	27	-	1	31	-	1	44	-	1	41	-	1
54	-	1	41	-	1	28	-	1	32	-	1	45	-	1	42	-	1
55	-	1	42	-	1	29	-	1	33	-	1	46	-	1	43	-	1
56	130	1	43	-	1	30	-	1	35	-	1	47	-	1	45	-	1
57	-	1	44	-	1	31	-	1	36	-	1	49	-	1	46	-	1
58	-	1	45	-	1	32	-	1	37	-	1	50	-	1	47	-	1
59	-	1	46	-	1	33	-	1	38	-	1	51	-	1	48	-	1
60	-	1	47	-	1	34	114	1	41	-	1	52	-	1	49	-	1
61	-	1	48	-	1	35	-	1	42	-	1	53	-	1	51	-	1
62	-	1	49	-	1	39	-	1	43	-	1	55	-	1	52	-	1
63	-	1	50	-	1	40	-	1	44	-	1	56	-	1	53	-	1
64	-	1	51	-	1	41	-	1	47	-	1	57	-	1	54	-	1
65	-	1	52	-	1	42	-	1	48	-	1	58	-	1	55	-	1
66	-	1	53	-	1	43	-	1	49	-	1	59	-	1	57	-	1
67	-	1	54	-	1	44	-	1	50	-	1	61	-	1	58	-	1
68	-	1	55	-	1	45	-	1	51	-	1	62	-	1	59	-	1
69	-	1	56	-	1	46	-	1	53	-	1	63	-	1	60	-	1
70	-	1	57	-	1	47	-	1	54	-	1	64	-	1	61	-	1
71	-	1	58	-	1	48	-	1	55	-	1	65	-	1	63	-	1
72	-	1	59	-	1	49	-	1	56	-	1	67	-	1	64	-	1
73	-	1	60	-	1	51	134	1	57	-	1	68	-	1	65	-	1

**Bold pack quantities:** minimum quantities to be ordered. **Red catalogue number:** new products

Cat.Nos	Page N°	Pack	Cat.Nos	Page N°	Pack	Cat.Nos	Page N°	Pack	Cat.Nos	Page N°	Pack	Cat.Nos	Page N°	Pack	Cat.Nos	Page N°	Pack
4 225 66	134	1	4 306 20	645	5/100	4 311 66	153	1/5	5 553 08	328	5	5 720 57	398	5/40	5 722 36	395	1/20
67	-	1	21	641	10/20	67	-	1/5	09	-	5	67	399	5/40	38	364	1/20
69	-	1	24	645	1/6	70	-	1/2	24	-	5	71	372	10/100	39	-	1/20
70	-	1	25	-	1/6	71	-	1/2	25	-	5	73	-	1	40	365	1/10
71	-	1	26	-	1	72	-	1/2	26	-	5	74	399	5/50	41	364	1/12
72	-	1	30	642	1/5	73	-	1/2	28	-	5	78	372	5/50	45	398	1/20
73	-	1	32	-	1/5	74	-	1/2	29	-	5	80	367	5/30	46	397	1/20
75	-	1	35	-	1	75	-	1/2	54	-	5	81	-	5/20	47	398	10/100
76	-	1	36	-	1/8	76	-	1/2	55	-	5	82	-	5/20	48	399	10/100
77	-	1	37	-	1/5	77	-	1/2	56	-	5	83	693	1/10	50	623	1/10
78	-	1	38	-	1/5	78	-	1/2	58	-	5	87	367	5/30	51	622	1/10
81	-	1	40	-	1/12	79	-	1/2	59	-	5	88	-	5/30	52	-	1/10
82	-	1	42	-	1	4 500 00	758	2	84	-	5	89	382	1/30	53	397	1/20
83	-	1	44	-	1	01	-	2	85	-	5	90	-	1/10	54	625	1
84	-	1	45	-	1/5	02	-	2	86	-	5	91	381	1/10	55	626	1
86	137	1	51	643	1	03	-	2	88	-	5	92	382	1	59	397	10/50
87	-	1	52	-	1	04	-	2	89	-	5	93	-	1/10	63	368	1/10
88	-	1	60	-	1/5	05	-	2	5 554 14	328	5	94	378	1/10	70	379	10/100
89	-	1	61	-	1/6	06	-	2	15	-	5	96	381	1/10	72	382	1/20
90	-	1	62	-	1/5	07	-	2	16	-	5	97	-	1/10	73	-	1/20
91	-	1	73	645	1	10	753	1	18	-	5	5 721 00	371	10/100	74	381	1/20
92	-	1	83	-	1	11	-	1	19	-	5	01	-	10/100	75	378	1/20
93	-	1	84	-	1	12	-	1	21	-	5	02	-	10/100	76	382	1/20
94	-	1	87	-	10/100	13	-	1	34	-	5	03	-	10/100	77	379	1/20
			90	644	1	14	-	1	35	-	5	04	370	10/100	78	381	1/20
4 305 00	638	1/12	91	-	1				36	-	5	05	-	10/100	79	-	1/20
01	-	1/10	92	-	1				38	-	5	10	-	10/100	80	379	10/100
02	-	1/10	93	-	1				39	-	5	11	-	10/100	81	381	1/20
04	-	1/4							41	-	5	12	371	10/100	82	-	1/20
05	-	1/12							54	-	5	13	-	10/100	83	379	1/20
06	-	1/6							55	-	5	14	-	10/100	84	-	1/20
07	-	1/4							56	-	5	15	-	10/100	85	381	1/50
08	-	1/4							58	-	5	16	370	10/100	88	-	1/20
09	-	1/10							59	-	5	17	-	10/100	89	-	1/50
12	-	1/12							84	-	5	18	-	10/100			
14	-	1/12							85	-	5	19	-	10/100	5 723 00	374	10/100
15	-	1							86	-	5	21	371	10/100	01	-	5/40
17	-	1							88	-	5	22	-	10/100	02	375	10/100
20	-	1							89	-	5	23	370	10/100	03	-	10/100
21	639	1							91	-	5	24	371	10/100	04	-	10/100
22	-	1										30	370	5/50	06	-	10/100
23	-	1										31	371	5/50	07	383	10/100
24	-	1										32	370	5/50	10	374	10/100
25	-	1										33	-	5/50	12	-	10/100
30	640	1/12										34	-	5/50	13	-	10/100
31	-	1/12										35	-	5/50	14	375	10/100
32	-	1/12										40	369	10/60	15	-	10/100
33	-	1/12										41	-	5/30	16	-	10/100
34	-	1/10										43	-	10/60	17	-	10/100
35	-	1/24										44	-	10/60	19	383	10/100
36	-	1/10										45	-	5/30	20	-	10/100
37	-	1/6										46	-	5/30	21	-	5/50
38	-	1/12										47	-	5/50	22	375	10/100
39	-	1/24										49	-	5/30	23	-	10/100
40	638	1/12										50	-	5/30	24	-	10/100
41	-	1										51	-	5/30	30	376	10/100
42	-	1										53	397	1/10	31	-	10/100
43	-	1										55	-	1/10	32	-	10/100
44	-	1										57	369	10/60	33	-	10/100
70	646	1										63	374	10/100	35	-	10/100
71	-	1										70	-	10/100	36	-	10/100
72	-	1										71	-	10/100	37	378	10/100
73	-	1										72	-	10/100	38	-	10/100
74	-	1/6													39	375	1/20
75	640	1/10													41	383	10/100
78	644	1													42	-	10/100
80	640	1/20													43	-	5/50
81	-	1/20													49	375	10/100
82	-	1/20													50	-	5/50
84	644	1/14													51	-	10/100
85	-	1/14													52	-	10/100
86	640	1/6													53	-	5/50
87	-	1/10													54	-	10/100
88	-	1													55	-	10/100
89	-	1													57	-	5/50
91	-	1/8													58	-	10/100
92	-	1/15													59	-	10/100
93	-	1/24													60	368	1/12
94	639	1													61	-	1/12
95	-	1													62	367	1/20
96	-	1													63	-	1/20
97	-	1													70	381	1/10
98	-	1													76	377	1/10
99	-	1/10													77	-	1/10
															90	384	10/50
4 306 00	640	1/24													92	-	5/2
01	-	1/24													96	-	2/10
02	-	1/20															
03	639	1															
04	646	1/10															

**Bold pack quantities:** minimum quantities to be ordered. **Red catalogue number:** new products

Cat.Nos	Page N°	Pack	Cat.Nos	Page N°	Pack	Cat.Nos	Page N°	Pack	Cat.Nos	Page N°	Pack	Cat.Nos	Page N°	Pack	Cat.Nos	Page N°	Pack
5 724 50	360	10/100	5 726 12	371	10/100	5 728 10	374	10/100	5 731 13	361	10/100	5 735 90	382	1/10	5 739 52	422	1/3
51	-	5/40	13	-	10/100	12	-	10/100	14	-	10/100	92	-	1	53	-	1/3
52	366	10/100	14	-	10/100	13	-	10/100	15	-	10/100	93	-	1/10	<b>58</b>	421	1
53	-	10/100	16	370	10/100	14	375	10/100	16	-	5/50	96	381	1/10	77	418	1/4
54	-	10/100	17	-	10/100	15	-	10/100	17	-	5/50				78	-	1
55	-	10/100	18	-	10/100	16	-	10/100	18	-	5/50	5 736 55	362	1/10	81	-	1
56	-	10/100	19	-	10/100	17	-	10/100	20	-	10/100				82	-	1/9
57	-	10/100	21	371	10/100	18	378	10/100	21	-	10/100	5 737 01	364	1/10	84	417	1/4
60	370	10/100	<b>22</b>	-	10/100	22	375	10/100	22	-	10/100	<b>16</b>	410	1	85	420	1/3
<b>61</b>	371	10/100	23	370	10/100	23	-	10/100	23	-	10/100	<b>17</b>	-	1	88	419	1/3
62	370	10/100	24	371	10/100	24	-	10/100	24	-	10/100	19	368	10/100	90	-	1/4
63	-	10/100	30	370	5/50	30	376	10/100	25	-	10/100	20	-	10/100	91	420	1/3
65	371	5/50	31	371	5/50	31	-	10/100	26	-	5/50	22	398	10/100	96	411	1/12
66	-	10/100	32	370	5/50	32	-	10/100	28	-	5/50	23	399	10/100	97	-	1/4
67	370	5/50	33	-	5/50	33	-	10/100	30	-	5/40	24	398	10/100	98	419	1/28
70	382	1/10	34	-	5/50	35	-	10/100	31	-	5/40	25	399	10/100	99	-	1
72	-	1	35	-	5/50	36	-	10/100	32	-	5/40	34	398	10/100			
73	-	1/10	40	369	10/60	37	378	10/100	33	-	5/40	35	399	10/100	5 740 00	362	1/10
74	378	1/10	43	-	10/60	38	-	10/100	50	363	10/100	36	398	10/100	01	-	1/10
76	381	1/10	44	-	10/60	39	375	1/20	51	-	5/50	37	399	10/100	02	-	1/10
78	-	1/10	45	-	5/30	41	383	10/100	52	-	5/50	72	382	1/20	03	-	1/10
83	372	1	46	-	5/30	42	-	10/100	53	-	5/50	73	-	1/20	07	364	1/10
88	-	5/50	47	-	5/50	43	-	5/50	60	361	10/100	74	378	1/20	11	422	1/10
			49	-	5/30	49	375	10/100	61	-	10/100	84	398	10/100	31	595	1/30
5 725 00	363	10/100	50	-	5/30	50	-	5/50	62	-	5/50	85	399	10/100	34	366	1/30
01	-	5/50	51	-	5/30	51	-	10/100	63	-	5/50	86	398	10/100	44	419	1/24
02	-	10/100	53	397	1/10	52	-	10/100	65	-	5/50	87	399	10/100	45	-	5/20
03	-	5/50	55	-	1/10	53	-	5/50	70	-	10/100	90	404	1/20	46	412	1/30
04	360	10/100	57	369	10/60	54	-	10/100	71	-	5/50	91	-	1/20	47	366	1/30
05	-	10/100	63	374	10/100	55	-	10/100	72	-	5/50	92	-	1/10	48	412	1/30
06	-	10/100	70	-	10/100	57	-	5/50	73	-	10/100	93	-	1/10	49	366	1/30
08	-	5/40	71	-	10/100	58	-	10/100	75	-	10/100	94	398	5/50	50	362	1/10
09	-	10/100	72	-	10/100	59	-	10/100	76	-	10/100	95	399	5/50	51	-	1/10
10	-	10/100				76	377	1/10	77	-	5/50	96	398	5/50	52	-	1/10
11	-	5/50	5 727 01	368	5/40	77	-	1/10	80	363	5/50	97	399	5/50	53	-	1/10
13	-	5/40	02	-	5/40	84	693	1/10	86	383	10/100				57	364	1/10
14	-	5/40	03	-	<b>1/1</b>				88	383	10/100	5 738 58	405	1/10	81	366	1/30
15	363	5/50	04	398	5/50	5 730 00	363	10/100	96	-	5/50	60	-	1/10	82	-	1/20
16	-	5/50	11	364	1/10	01	-	10/100				62	-	1/10	84	367	1/20
20	371	10/100	13	-	1/20	02	-	10/100	5 732 19	368	10/100	64	-	1/10	89	395	1
21	-	10/100	15	368	5/50	10	361	10/100	20	-	10/100	66	-	1/10	91	-	1
22	-	1/10	17	-	1/10	11	-	10/100	22	398	10/100	70	404	1/20	92	-	1/15
30	363	10/100	18	-	1/10	12	-	10/100	23	399	10/100	82	398	5/50	94	366	1/30
31	-	5/50	19	-	10/100	13	-	10/100	24	398	10/100	83	399	5/50	96	412	1/30
32	-	5/50	20	-	10/100	14	-	10/100	25	399	10/100	84	398	5/50	97	366	1/30
33	-	10/100	22	398	5/50	15	-	10/100	34	398	10/100	85	399	5/50	98	412	1/30
34	360	10/100	23	399	5/50	16	-	5/50	35	399	10/100				99	366	1/30
35	-	10/100	24	398	5/50	17	-	5/50	36	398	10/100	5 739 00	410	1/12			
36	-	5/50	25	399	5/50	18	-	5/50	37	399	10/100	01	-	1/12	5 742 03	396	1/20
37	-	5/50	26	366	1/20	20	-	10/100	72	382	1/20	02	-	1/3			
38	-	10/100	27	367	1/20	21	-	10/100	73	-	1/20	03	-	1/3			
40	-	5/50	30	397	1/20	22	-	10/100	74	378	1/20	04	409	1	5 743 00	362	1/10
41	-	10/100	35	395	1/20	23	-	10/100	84	398	10/100	05	-	1	01	-	1/10
42	-	5/50	36	-	1/20	24	-	10/100	85	399	10/100	06	-	1	02	-	1/10
43	-	10/100	<b>38</b>	364	1/20	25	-	10/100	86	398	10/100	07	-	1	03	-	1/10
44	-	10/100	<b>39</b>	-	1/20	26	-	5/50	87	399	10/100	12	-	1	05	365	1/10
46	-	10/100	40	365	1/10	28	-	5/50	89	398	5/50	13	-	1	07	-	1/10
47	-	10/100	41	364	1/12	30	-	5/40	94	398	5/50	18	414	1	11	422	1/10
48	-	10/100	50	623	1/10	31	-	5/40	95	399	5/50	19	-	1	<b>18</b>	365	1/20
49	-	10/100	51	622	1/10	32	-	5/40	96	398	5/50	20	-	1/12	<b>19</b>	-	1/20
51	362	1/10	52	-	1/10	33	-	5/40	97	399	5/50	21	-	1/12	<b>38</b>	-	1/20
54	398	5/50	53	397	1/20	50	363	10/100	5 733 74	378	1/10	22	-	1/12	<b>39</b>	395	5/60
56	363	5/50	59	-	10/50	51	-	5/50	78	381	1/10	23	-	1/12	<b>47</b>	-	5/60
57	398	5/40	63	368	<b>1/10</b>	52	-	5/50	82	398	5/50	24	-	1/12	<b>48</b>	-	5/60
67	399	5/40	70	379	10/100	53	-	10/100	83	399	5/50	25	-	1/12	<b>49</b>	-	5/60
71	372	10/100	72	382	1/20	60	361	10/100	84	398	5/50	26	418	1/3	50	362	1/10
73	-	1	73	-	1/20	61	-	10/100	85	399	5/50	27	-	1/3	51	-	1/10
74	399	5/50	74	381	1/20	62	-	5/50	93	372	1	28	-	1	52	-	1/10
78	372	1/20	75	378	1/20	63	-	10/100	98	-	1/20	29	-	1	53	-	1/10
80	367	5/30	76	382	1/20	65	-	5/50				30	-	1	55	365	1/10
81	-	5/20	77	379	1/20	70	-	10/100	5 734 55	362	1/10	32	419	1/24	57	-	1/10
82	-	5/20	78	381	1/20	71	-	5/50	93	-	1/20	33	-	1/24	<b>94</b>	395	2/48
87	-	5/30	79	-	1/20	72	-	10/100				34	416	1	<b>95</b>	-	2/48
90	382	1	80	379	10/100	73	-	10/100	5 735 01	364	1/10	35	-	1	<b>96</b>	-	2/48
91	381	1/10	81	381	1/20	75	-	10/100	<b>02</b>	396	1/20	36	-	1/12	<b>97</b>	-	2/48
92	382	1/10	82	-	1/20	76	-	10/100	<b>03</b>	-	1/20	37	-	1/12			
93	-	1/10	83	379	1/20	77	-	10/100	<b>04</b>	-	1	38	-	1/12	5 744 04	396	1/20
94	378	1/10	84	-	1/20	78	-	10/100	<b>05</b>	-	1	39	-	1/12	<b>64</b>	408	5/120
96	381	1/10	85	381	1/45	80	363	5/50	<b>12</b>	-	1	40	-	1/12	<b>65</b>	-	5/120
97	-	1/10	88	-	1/20	86	383	10/100	<b>13</b>	-	1	41	-	1/12	<b>66</b>	-	5/60
			89	-	1/50	96	-	5/50	<b>44</b>	403	1/10	44	-	1/12	<b>67</b>	-	5/60
5 726 00	371	10/100				5 731 00	363	10/100	<b>45</b>	-	1/10	45	-	1/12	<b>68</b>	-	5/120
01	-	10/100	5 728 00	374	10/100	01	-	10/100	<b>46</b>	-	1/10	46	-	1	<b>69</b>	-	5/120
03	-	10/100	01	-	5/40	01	-	10/100	<b>47</b>	-	1/10	47	-	1	70	-	5/60
04	370	10/100	02	375	10/100	02	-	10/100	<b>48</b>	-	1/10	48	-	1/12	<b>71</b>	-	5/60
05	-	10/100	03														

Cat.Nos	Page N°	Pack	Cat.Nos	Page N°	Pack	Cat.Nos	Page N°	Pack	Cat.Nos	Page N°	Pack	Cat.Nos	Page N°	Pack	Cat.Nos	Page N°	Pack
5 744 75	408	5/120	5 745 75	402	5/50	5 751 32	383	5/50	5 753 73	387	1/10	5 756 52	390	10/120	5 761 58	386	5/60
76	-	5/60	76	-	5/50	40	-	5/60	74	-	1/10	53	389	1/40	59	387	1/10
77	-	5/60	77	-	5/50	41	-	5/50	75	-	1/10	54	-	1/40	60	-	1/30
78	-	5/120	78	-	5/50	42	-	5/60	76	-	1/10	55	-	1/40	61	386	1/30
79	-	5/120	79	-	5/50	50	386	5/50	90	386	2/10	56	-	1/40	62	-	1/30
80	-	5/60	80	-	5/50	60	-	5/50	91	-	2/10	60	390	5/40	63	387	1/10
81	-	5/60	81	-	5/50	61	-	5/100	92	-	2/10	61	-	5/40	64	-	1/30
82	-	5/120	82	-	5/50	62	-	5/100				62	-	5/40	65	-	1/30
83	-	5/120	83	-	5/50	63	387	1/40	5 754 00	386	2/8	63	391	1/20	66	-	1/30
84	-	5/60	84	-	5/50	64	-	1/40	01	-	2/10	64	-	1/20	67	-	1/30
85	-	5/60	85	-	5/50	65	-	1/40	02	-	2/8	65	-	1/20	68	386	5/60
86	-	5/120	86	-	5/50	66	-	1/40	10	383	10/120	66	-	1/20	69	387	1/30
87	-	5/120	89	395	1	90	384	5/25	11	-	10/120	70	390	5/40	70	-	1/40
88	-	5/60	91	-	1				12	-	10/120	71	-	5/40	71	386	1/40
89	-	5/60	92	-	1/15	5 752 00	386	10/180	50	384	10/100	72	-	5/40	72	-	1/40
90	-	5/120	96	402	5/50	01	-	10/180	60	-	5/30	73	391	1/40	73	387	1/20
91	-	5/120	97	-	5/50	02	-	10/180	70	-	10/100	74	-	1/20	74	-	1/20
92	-	5/120				03	387	1/40	80	-	5/50	76	-	1/40	75	-	1/40
93	-	5/120	5 750 10	388	10/120	04	-	1/40							76	-	1/40
94	-	5/60	11	-	5/50	05	-	1/40	5 755 00	388	10/60	5 760 00	385	10/60	77	-	1/20
95	-	5/60	12	-	5/50	06	-	1/40	01	-	5/50	01	-	5/60	78	386	5/50
			20	392	5/50	10	386	10/180	02	-	5/50	02	-	10/60	79	387	1/40
5 745 03	410	1/3	21	-	5/50	11	-	10/180	10	-	5/60	03	-	10/60	80	-	1/40
04	-	1/3	22	-	5/50	12	-	10/180	11	-	5/60	11	-	5/50	81	386	1/40
05	408	5/120	23	393	1/30	13	387	1/40	12	-	5/60	12	-	5/30	82	-	1/40
06	-	5/120	24	-	1/30	14	-	1/40	13	389	1/30	13	384	10/100	83	387	1/20
07	-	5/120	25	-	1/30	15	-	1/40	14	-	1/30	15	-	10/100	84	-	1/40
08	-	5/120	26	-	1/30	16	-	1/40	16	-	1/30	16	-	10/100	85	-	1/40
09	-	5/120	30	388	5/50	20	388	10/120	20	388	5/30	20	385	5/60	86	-	1/40
10	-	5/120	31	-	5/50	21	-	10/120	21	-	5/30	21	-	10/100	87	-	1/40
11	-	5/120	32	-	5/50	22	-	10/120	22	-	5/30	22	-	2/10	88	386	1/40
12	-	5/120	33	389	1/30	30	-	10/120	23	389	1/10	30	-	10/50	89	387	1/40
13	-	5/60	34	-	1/30	31	-	10/120	24	-	1/20	31	-	5/40	90	-	1/40
14	-	5/60	35	-	1/30	32	-	10/120	26	-	1/20	32	-	5/40	91	386	1/40
15	-	5/120	36	-	1/30	40	390	10/120	40	386	5/60	40	-	10/50	92	-	1/40
16	-	5/120	40	388	5/50	41	-	10/120	41	-	5/60				95	387	1/40
17	-	5/120	41	-	5/50	42	-	10/120	42	-	5/60	5 761 00	387	1/40	96	-	1/40
18	-	5/120	42	-	5/50	43	389	1/40	43	387	1/30	01	386	1/40	98	386	1/40
19	-	5/120	43	389	1/10	44	-	1/40	44	-	1/30	02	-	1/40			
20	-	5/120	44	-	1/10	45	-	1/40	45	-	1/10	03	387	1/40	5 762 00	387	1/30
21	-	5/120	45	-	1/10	46	-	1/40	46	-	1/10	04	-	1/40	01	386	1/30
22	-	5/120	46	-	1/10	50	390	10/120	50	386	5/60	05	-	1/40	02	-	1/30
23	-	5/120	50	392	5/25	51	-	10/120	51	-	5/60	06	-	1/40	03	387	1/30
24	-	5/120	51	-	5/25	52	-	10/120	52	-	5/60	07	-	1/40	04	-	1/30
25	-	5/120	52	-	5/25	53	389	1/40	53	387	1/30	08	386	5/50	05	-	1/30
26	-	5/120	53	393	1/20	54	-	1/40	54	-	1/30	09	387	1/40	06	-	1/30
27	-	5/120	54	-	1/20	55	-	1/40	56	-	1/30	10	-	1/40	07	-	1/30
28	-	5/120	56	-	1/20	56	-	1/40	60	386	5/100	11	386	1/40	08	386	1/40
29	-	5/120	60	392	2/16	60	390	5/35	61	-	5/50	12	-	1/40	09	387	1/30
30	-	5/120	61	-	2/10	61	-	5/35	62	-	5/100	13	387	1/40	10	-	1/40
31	-	5/60	62	-	2/16	62	-	5/35	63	387	1/40	14	-	1/40	11	386	1/40
32	-	5/60	70	386	5/50	63	391	1/40	64	-	1/40	15	-	1/40	12	-	1/40
33	-	5/60	71	-	5/50	64	-	1/40	65	-	1/40	16	-	1/40	13	387	1/40
34	-	5/60	72	-	5/60	65	-	1/20	66	-	1/40	17	-	1/40	14	-	1/40
35	-	5/60	73	387	1/30	66	-	1/40				18	386	5/20	15	-	1/40
36	-	5/60	74	-	1/30	70	390	10/120	5 756 00	392	10/120	19	387	1/40	16	-	1/40
37	-	5/60	75	-	1/30	71	-	10/120	01	-	5/20	20	-	1/40	17	-	1/40
38	-	5/60	76	-	1/30	72	-	10/120	02	-	5/20	21	386	1/40	18	386	1/40
39	-	5/60	80	386	5/50	73	389	1/40	03	393	1/40	22	-	1/40	19	387	1/40
40	-	5/60	81	-	5/50	74	-	1/40	04	-	1/40	23	387	1/40	20	393	1/40
41	-	5/60	82	-	5/50	75	-	1/40	05	-	1/20	24	-	1/40	21	392	1/20
42	-	5/60	83	387	1/30	76	-	1/40	06	-	1/40	25	-	1/40	22	-	1/40
43	-	5/60	84	-	1/30	80	390	5/35	10	386	10/180	26	-	1/40	23	393	1/20
44	-	5/60	85	-	1/30	81	-	5/35	11	-	10/180	27	-	1/40	24	-	1/20
45	-	5/120	86	-	1/30	82	-	5/35	12	-	10/180	28	386	5/50	25	-	1/40
46	-	5/120	90	386	10/100	83	391	1/20	13	387	1/40	29	387	1/40	26	-	1/40
47	-	5/120	91	-	10/100	84	-	1/40	14	-	1/40	31	386	1/30	27	-	1/20
48	-	5/120	92	-	10/100	85	-	1/20	15	-	1/40	32	-	1/30	28	392	5/50
55	402	5/50	93	387	1/40	86	-	1/40	16	-	1/40	35	387	1/30	29	393	1/20
56	-	5/50	94	-	1/40	90	390	5/35	20	388	10/60	36	-	1/30	30	-	1/40
57	-	5/50	95	-	1/40	91	-	5/35	21	-	10/120	40	-	1/30	31	392	1/40
58	-	5/50	96	-	1/40	92	-	5/35	22	-	10/120	41	386	1/30	32	-	1/40
60	-	5/50				93	391	1/40	30	390	10/120	42	-	1/30	33	393	1/20
61	-	5/50	5 751 00	386	10/120	94	-	1/40	31	-	10/120	43	387	1/30	34	-	1/20
62	-	5/50	01	-	10/120	96	-	1/40	32	-	10/120	44	-	1/30	35	-	1/40
63	-	5/50	02	-	10/120				33	389	1/40	45	-	1/30	36	-	1/20
64	-	5/50	03	387	1/30	5 753 00	390	5/35	34	-	1/40	46	-	1/30	37	-	1/20
65	-	5/50	04	-	1/30	01	-	5/35	35	-	1/40	47	-	1/30	38	392	5/20
66	-	5/50	05	-	1/30	02	-	5/35	36	-	1/40	48	386	5/60	39	393	1/20
67	-	5/50	06	-	1/30	03	391	1/40	40	390	5/40	49	387	1/30	40	-	1/40
68	-	5/50	20	386	5/50	04	-	1/40	41	-	5/40	50	-	1/10	41	392	1/20
69	-	5/50	21	-	5/100	06	-	1/40	42	-	5/40	51	386	1/30	42	-	1/40
70	-	5/50	22	-	5/100	60	383	5/35	43	391	1/20	52	-	1/30	43	393	1/40
71	-	5/50	23	387	1/40	61	-	5/35	44	-	1/20	53	387	1/10	44	-	1/20
72	-	5/50	24	-	1/40	62	-	5/35	45	-	1/20	54	-	1/10	45	-	1/40
73	-	5/50	26	-	1/40	70	386	5/30	46	-	1/40	55	-	1/30	46	-	1/40
74	-	5/50	30	383	5/50	71	-	5/30	50	390	10/60	56	-	1/30	47	-	1/40
			31	-	5/20	72	-	5/30	51	-	10/120	57	-	1/10	48	392	5/20





Cat.Nos	Page N°	Pack	Cat.Nos	Page N°	Pack	Cat.Nos	Page N°	Pack	Cat.Nos	Page N°	Pack	Cat.Nos	Page N°	Pack	Cat.Nos	Page N°	Pack
6 361 78	300	25/150	6 430 21	649	1	6 512 16	564	100	6 612 96	606	1/4	6 624 04	612	1/8	6 646 55	450	20/120
83	-	25/50	23	-	1	20	-	100	99	-	1/10	23	-	1/8	61	447	10/100
6 362 00	299	60	65	-	1/10	25	-	100	6 614 01	612	1/8	24	-	1/8	62	-	10/100
01	-	56	71	-	1/10	32	-	50	02	-	1/8	31	-	1	64	-	10/100
02	-	56	72	-	1/10	40	-	50	03	-	1/8	33	-	1	65	-	10/100
06	-	48	75	-	1	50	-	50	04	-	1/8	34	-	1	69	450	20/120
07	-	48	6 463 37	708	1	63	-	25	23	-	1/8	40	-	1	71	-	20/120
08	-	40	40	-	1	6 514 16	568	30	24	-	1/8	6 625 01	615	1/4	96	449	1
12	-	32	41	-	1	20	-	30	31	-	1	02	-	1/4	6 647 01	443	10/100
13	-	32	42	-	1	25	-	30	33	-	1	06	-	1/4	02	-	10/100
17	-	24	50	-	1	32	-	15	34	-	1	07	-	1/4	04	-	10/100
25	-	16	54	-	1	6 516 01	568	100/500	40	-	1	21	-	1/4	05	-	1/100
6 373 58	766	32	62	-	1	02	-	100/500	6 615 01	615	1/4	23	-	1/4	08	-	10/100
6 380 00	737	10/100	66	-	1	03	-	50/250	02	-	1/4	25	-	1/4	09	-	10/100
6 381 00	740	154	68	-	1	04	-	25/125	11	-	1/4	43	611	1/6	09	-	10/100
01	-	10/500	69	-	1	08	-	100/500	12	-	1/4	45	-	1/6	10	-	10/100
02	-	10/500	70	-	1	09	-	50/250	21	-	1/4	60	-	1	11	445	10/100
03	-	10/500	71	-	1	11	-	50/250	23	-	1/4	61	-	1	13	443	1/20
04	-	10/500	72	-	1	12	-	50/250	25	-	1/4	6 626 03	609	1/10	14	-	1/20
05	-	10/500	73	-	1	13	-	25/125	35	-	1/4	06	-	1/10	15	-	10/100
06	-	10/500	80	-	1	18	-	50/250	36	-	1/4	07	-	1/10	16	-	10/100
09	-	80	83	-	1	19	-	25/125	37	-	1/4	10	-	1/10	21	-	10/100
10	-	150	6 464 00	708	1	20	-	25/125	41	611	1/6	31	608	1/10	25	-	10/100
11	-	10/500	01	-	1	26	-	20/100	43	-	1/6	33	-	1/10	26	-	10/100
12	-	10/500	02	-	1	27	-	10	45	-	1/6	34	-	1/10	31	445	10/100
13	-	10/500	03	-	1	28	-	25	6 616 01	609	1/10	40	-	1/10	32	-	10/100
14	-	10/500	04	-	1	32	-	1/10	02	-	1/10	6 627 02	609	1/10	34	-	10/100
15	-	10/500	20	709	1	33	-	1	03	-	1/10	05	-	1/10	35	446	10/100
16	-	10/500	21	-	1	34	-	1	05	-	1/10	06	-	1/10	45	-	10/50
19	-	50	25	-	1	36	-	1/5	06	-	1/10	07	-	1/10	46	445	10/50
20	-	96	30	-	1	6 535 30	780	1/5	07	-	1/10	09	-	1/10	47	-	10/100
21	-	10/500	31	-	1	31	-	1/5	10	-	1/10	14	-	1/10	48	446	10/100
22	-	10/500	50	708	1	50	-	1/5	20	608	1/10	15	-	1/10	50	447	10/100
23	-	10/500	52	-	1	51	-	1/10	21	-	1/10	6 643 01	443	1	51	-	10/100
24	-	10/500	53	-	1	52	-	1/5	22	-	1/10	15	-	10/100	60	-	10/100
25	-	10/500	54	-	1	53	-	1/5	31	-	1/10	446	1	6 645 00	63	-	10/100
26	-	10/500	55	-	1	70	781	1/5	32	-	1/10	6 645 01	449	20/200	68	446	10/100
29	-	42	60	-	1	72	-	1/5	33	-	1/10	03	443	10/100	69	-	10/100
30	-	70	62	-	1	74	-	1	34	-	1/10	06	449	20/200	70	-	10/100
31	-	10/500	63	-	1	75	-	1	40	-	1/10	07	-	20/200	75	-	10/100
32	-	10/500	65	-	1	77	-	1	50	-	1/10	20	-	20/200	77	-	10/100
33	-	5/250	66	-	1	6 571 06	328	1	51	-	1/10	22	-	20/200	79	447	10/100
34	-	5/250	71	-	1	6 607 80	737	1/5	54	-	1/10	23	-	10/120	91	445	10/100
35	-	10/500	72	-	1	81	-	1/5	55	-	1/10	27	-	20/200	93	-	1/20
36	-	10/500	74	-	1	82	-	1/5	58	-	1	29	-	20/200	95	446	10/50
39	-	66	75	-	1	83	-	1	59	-	1	29	-	5/20	98	447	10/50
40	741	80	76	-	1	84	-	1/4	62	-	1	38	-	5/20	99	-	5/30
41	-	10/100	80	-	1	85	-	1/4	63	-	1	39	-	20/200	6 648 01	443	10/100
42	-	5/250	81	-	1	86	-	1	64	-	1/10	40	-	20/200	02	-	10/100
43	-	10/100	84	-	1	88	-	1	65	-	1/5	41	446	10	04	-	10/100
44	-	10/100	85	-	1	89	-	1	70	616	5	42	449	10/100	05	-	1/100
45	-	10/500	86	-	1	90	-	1/4	71	-	5	43	445	10	08	-	10/100
46	-	10/500	87	-	1	91	-	1	72	-	5	44	449	10/100	09	-	10/100
49	-	36	6 465 01	709	1	92	-	1	80	-	5	44	449	10/100	09	-	10/100
50	-	60	02	-	1	6 608 65	616	5/200	88	-	5	52	450	20/120	10	-	10/100
51	-	10/100	05	-	1	66	-	5/200	90	-	5	53	-	20/120	11	445	10/100
52	-	10/100	06	-	1	67	-	5/200	91	-	1	54	-	5/20	13	443	1/20
53	-	10/100	07	-	1	69	-	1	92	-	5	55	-	20/120	14	-	1/20
54	-	10/100	08	-	1	70	-	1	6 617 01	609	1/10	61	447	10/100	16	-	1/100
55	-	10/500	09	-	1	71	-	1	02	-	1/10	62	-	10/100	21	-	10/100
56	-	10/500	10	-	1	72	-	1	05	-	1/10	64	-	10/100	25	-	10/100
59	-	60	20	-	1	74	-	5/200	06	-	1/10	65	-	10/100	31	445	10/100
60	-	40	21	-	1	75	-	5/200	07	-	1/10	69	450	20/120	32	-	10/100
61	-	10/100	50	-	1/10	76	-	5/200	09	-	1/10	71	-	20/120	34	-	10/100
62	-	10/100	51	-	1/10	6 609 61	617	1	10	-	1/10	96	449	1	35	446	10/100
63	-	10/100	55	-	1/10	62	-	1	11	-	1/10	6 646 00	449	20/200	45	-	10/50
64	-	5/50	56	-	1/10	63	-	1	12	-	1/10	03	443	10/100	46	445	10/50
65	-	5/250	60	-	1/10	64	-	1	13	-	1/10	06	449	20/200	47	-	10/100
66	-	5/250	61	-	1/10	66	-	1	20	-	10	07	-	20/200	48	446	10/100
68	-	40	6 499 14	076	1/10	67	-	1	6 618 00	606	5/50	20	-	20/200	50	447	10/100
70	-	32	6 500 13	574	20/400	69	-	1	01	-	5/50	22	-	20/200	51	-	10/100
71	-	10/100	15	-	20/400	70	-	1	02	-	5/50	23	-	10/120	60	-	10/100
72	-	5/50	6 503 31	777	10	71	-	1	03	-	5/50	27	-	20/200	63	-	10/100
73	-	5/50	90	-	1/20	72	-	1	40	-	5/50	29	-	5/20	68	446	10/100
74	-	5/50	6 510 16	564	100	6 611 60	606	1/4	50	-	5/50	38	-	5/20	69	-	10/100
75	-	5/250	20	-	100	80	-	1/4	51	-	5/50	39	-	20/200	70	-	10/100
76	-	5/250	25	-	100	90	-	1/4	6 621 60	606	1/4	40	-	5/20	75	-	10/100
80	-	24	32	-	50	6 612 81	606	1/12	80	-	1/4	41	446	10	77	-	10/100
81	-	5/50	40	-	50	92	-	1/4	90	-	1/4	42	449	10/100	79	447	10/100
82	-	5/50	50	-	50	93	-	1/4	6 624 01	612	1/8	43	445	10	91	445	10/100
83	-	5/50	50	-	50	94	-	1/4	02	-	1/8	44	449	10/15	93	-	1/20
84	-	10/100	50	-	50				03	-	1/8	52	450	20/120	95	446	10/50
86	-	10/100										53	-	20/120	98	447	10/50
												54	-	20/120	99	-	5/30

**Bold pack quantities:** minimum quantities to be ordered. **Red catalogue number:** new products

Cat.Nos	Page N°	Pack	Cat.Nos	Page N°	Pack	Cat.Nos	Page N°	Pack	Cat.Nos	Page N°	Pack	Cat.Nos	Page N°	Pack	Cat.Nos	Page N°	Pack
6 650 00	447	10/100	6 827 34	485	1/24	6 856 00	490	1/36	6 858 32	491	1/28	6 896 39	774	1	7 300 42	518	10/60
01	451	20/200	36	486	1/12	01	-	10/40	33	-	1/28	40	-	5	43	-	1/40
02	-	10/100	40	484	10/60	02	-	1/28	34	-	1/36	41	-	5	49	517	1/22
03	-	5/50	44	486	1/24	03	-	1/28	35	-	1/36	45	-	1	50	518	10/60
04	-	1/40	45	485	1/24	15	-	1/36	36	-	1/28	49	-	1	51	-	10/60
05	-	1/40	46	486	1/24	16	-	1/36	37	-	1/28	51	775	1	53	521	10/120
10	447	10/100	48	485	1/24	17	-	1/28	38	-	1/36	52	-	1	54	518	10/60
11	451	20/200	49	-	1/24	18	-	1/28	39	-	1/36	55	-	1	56	-	1/40
12	-	10/100	50	-	1/24	20	491	1/36	40	-	1/28	56	-	1	57	-	1/40
13	-	5/50	54	-	1/24	21	-	1/36	41	-	1/28	60	774	4/20	58	521	10/400
14	-	1/40	59	487	10/40	22	-	1/28	46	-	1/36	73	-	12/48	59	520	10/60
15	-	1/40	60	484	5/40	23	-	1/28	47	-	1/36	74	-	12/48	60	519	10/60
21	-	10/200	61	-	5/20	30	-	1/36	48	-	1/28	77	-	12/48	61	-	10/60
22	-	10/100	62	-	5/120	31	-	1/36	49	-	1/28	78	-	4/16	64	-	10/60
23	-	5/50	63	-	5/120	32	-	1/28	6 870 01	484	10/60	6 915 06	580	1/10	65	-	10/60
24	-	1/40	64	-	5/120	33	-	1/28	02	-	10/60	6 946 14	577	1/5	66	-	10/60
25	-	1/40	69	-	50/200	35	-	1/36	03	-	10/60	21	578	5	69	-	10/60
31	-	10/200	70	-	10/80	36	-	1/36	04	-	10/60	22	-	5	70	519	5/30
32	-	10/100	74	486	10/40	37	-	1/28	05	485	10/60	24	576	5	71	-	5/30
33	-	5/50	77	-	10/40	38	-	1/28	06	-	1/24	26	578	5	74	-	5/30
34	-	1/40	79	487	1/24	40	490	10/50	07	486	1/24	27	-	5	75	-	5/30
35	-	1/40	80	-	1/24	41	-	10/40	08	485	1/24	29	576	5	76	-	5/30
90	447	10/400	81	-	10/40	42	-	5/20	09	-	1/24	34	-	5	77	-	5/30
91	-	10/400	82	-	1/24	43	-	5/20	10	-	1/24	36	578	5	80	520	10/60
92	-	10/400	83	-	1/12	50	-	1/36	11	-	1/24	37	-	5	81	-	10/60
98	450	100	87	-	1/40	51	-	10/40	12	-	1/24	39	576	5	82	-	10/60
99	447	100/2000	98	488	1/12	52	-	1/28	13	486	10/60	41	578	5	83	-	10/60
6 651 01	444	1/20	6 828 75	486	5/20	53	-	1/28	14	485	1/24	43	-	5	84	-	10/60
02	-	1/20	6 829 00	488	1/24	55	-	1/36	15	486	1/24	46	-	5	85	-	5/60
03	-	1/20	01	-	1/24	56	-	10/40	16	-	10/40	47	-	5	86	-	5/30
11	-	1/20	02	-	1/24	57	-	1/28	17	-	1/12	48	-	5	88	-	10/60
12	-	1/20	03	-	1/24	65	491	1/36	18	485	1/24	51	-	5	89	-	10/60
14	-	1/20	04	-	1/24	66	-	10/40	24	488	1/8	56	-	5	90	-	1/22
17	-	1/20	05	-	1/24	67	-	1/28	25	487	1/40	64	577	1/5	91	516	10/120
18	-	1/20	06	-	1/24	68	-	1/28	30	-	10/40	66	-	1/5	92	-	10/120
19	-	1	07	-	1/12	95	-	1/36	31	-	1/24	70	574	1/8	93	-	10/60
95	446	10/100	08	-	1/12	96	-	10/40	32	-	1/24	71	-	1/8	94	-	10/60
96	-	10/100	09	-	1/12	97	-	1/28	33	-	1/24	6 950 01	578	10	95	521	10/120
6 652 14	444	1	10	-	1/24	6 857 15	491	1/36	34	-	1/12	02	-	10	96	-	10/60
17	-	1/20	13	484	100/400	16	-	10/40	35	-	1/24	03	-	10	99	518	10/150
18	-	1/20	17	488	1/12	17	-	1/28	36	-	10/40	04	576	10	7 301 00	518	10/90
95	446	10/100	18	486	5/20	18	-	1/28	40	486	10/40	06	578	10	07	517	5/60
6 771 37	798	10/100	31	-	10/100	20	-	1/36	41	-	10/40	07	-	10	10	518	10/60
38	-	10/100	6 830 00	485	1/24	21	-	10/40	42	488	1/24	08	-	10	12	-	10/60
6 805 30	490	10/50	01	-	1/24	22	-	1/28	43	-	1/24	09	576	10	20	-	5/30
31	-	10/50	05	486	10/40	23	-	1/28	44	-	1/24	14	-	10	22	-	10/60
41	-	10/50	07	-	10/40	45	-	1/36	45	-	1/24	16	578	10	24	517	10/60
42	-	10/50	10	-	10/40	46	-	10/40	46	-	1/12	17	-	10	30	-	10/60
43	-	10/50	11	484	10/80	47	-	1/28	50	484	50/200	18	-	10	31	-	10/60
44	-	10/30	12	488	1	48	-	1/28	51	488	1/24	19	576	10	32	-	10/60
49	-	10/20	13	487	1/24	55	-	1/36	52	-	1/24	6 998 11	076	1/10	33	-	10/60
6 806 01	489	1/10	17	484	10/120	56	-	10/40	53	484	10/80	12	-	1/10	34	-	10/60
02	-	1/10	18	-	5/120	57	-	1/28	54	488	1/24	6 998 11	12	-	35	-	10/60
03	-	1/10	26	-	10/240	58	-	1/28	55	-	1/12	7 000 00			40	518	10/60
04	-	1/5	33	487	10/40	58	-	1/28	56	-	1/12	7 300 00	517	10/60	44	-	10/60
06	-	5	36	-	10/40	70	-	1/36	57	-	1/12	01	-	10/60	45	-	10/60
08	-	5	38	-	10/30	71	-	10/40	58	484	10/120	02	-	10/60	50	517	1/20
09	-	5	76	484	10/60	72	-	1/28	59	-	100/400	03	-	10/60	56	-	1/40
11	-	1/10	77	-	10/60	73	-	1/28	60	-	5/120	04	-	10/60	57	-	1/40
12	-	1/10	78	-	10/60	75	490	1/36	61	-	5/120	05	-	10/60	58	521	10/400
13	-	1/10	79	485	10/60	76	-	1/36	62	-	5/120	06	-	10/60	61	519	5/30
14	-	1/5	80	486	10/60	77	-	1/28	63	-	5/120	07	-	10/60	62	-	10/60
19	-	1/5	81	-	10/60	82	-	1/28	67	-	5/40	08	-	5/30	80	542	10/400
32	-	1/20	6 831 54	485	5/20	82	-	1/28	68	-	5/20	09	-	10/60	81	-	10/220
33	-	1/20	59	417	1	6 858 00	490	10/40	69	486	10/40	10	518	10/60	82	543	10/60
34	-	1/7	6 845 53	555	1/20	01	-	1/28	72	491	1/5	11	517	5/60	83	-	10/60
35	-	1/7	54	-	1/20	02	-	1/28	73	-	5/25	12	518	10/60	84	-	1/40
6 826 01	490	10/50	56	-	1/20	04	-	1/36	74	-	5/15	19	521	10/60	85	-	1/40
16	-	10/40	60	-	1/20	05	-	10/40	80	486	10/60	20	518	5/30	86	-	1/25
31	-	5/20	70	-	1/20	06	-	1/28	82	487	10/40	21	-	5/30	87	-	1/25
46	-	5/20	85	-	1/20	07	-	1/28	85	-	10/40	22	-	10/60	90	-	1/25
70	489	1/2	6 846 02	555	1/20	14	-	10/50	87	-	10/30	23	-	10/60	91	542	10/200
71	-	1/5	03	-	1/20	15	-	10/40	6 873 17	488	1/12	24	517	10/60	92	-	10/200
73	491	1/5	04	-	1/20	16	-	5/20	21	485	1/24	26	521	5/30	93	-	10/100
76	-	5/25	11	-	1/20	17	-	5/20	22	-	1/24	28	-	5/30	94	-	10/100
78	-	5/15	19	-	1/10	18	-	1/36	23	-	1/12	29	-	5/30	7 310 00	522	1/40
6 827 21	485	1/24	20	-	1/10	19	-	1/36	27	-	1/24	32	-	5/30	01	-	1/40
22	-	1/24	26	-	1/10	21	-	1/28	6 890 28	384	1/10	33	-	10/60	02	-	1/40
23	-	1/12	28	-	1/10	22	-	1/28	36	-	1/20	36	-	10/60	03	-	1/40
26	488	1/12	36	-	1/10	27	-	1/36	38	-	1/20	37	-	10/60	04	-	1/22
27	485	1/24	60	-	1/20	28	-	1/36	6 896 30	774	5	40	518	10/60	05	-	1/40
			70	-	1/20	29	-	1/28	31	-	5	41	-	1/40	07	-	1/40
			85	-	1/20	30	491	1/36	34	-	1				09	523	1/40
			88	-	1/20	31	-	1/36									

**Bold pack quantities:** minimum quantities to be ordered. **Red catalogue number:** new products

Cat.Nos	Page N°	Pack	Cat.Nos	Page N°	Pack	Cat.Nos	Page N°	Pack	Cat.Nos	Page N°	Pack	Cat.Nos	Page N°	Pack	Cat.Nos	Page N°	Pack
7 310 10	523	1/40	7 312 71	525	1/22	7331 81	542	1/20	7 334 00	528	1/40	7 338 36	541	5/30	7 343 93	542	1/8
12	-	1/40	75	-	1/22	82	543	1/40	01	-	1/40	37	-	5/30	94	-	1/8
16	-	1/40	85	-	1/40	83	-	1/40	02	-	1/40	40	540	5/30			
19	527	1/40	86	-	1/22	84	-	1/40	03	-	1/40	41	-	1/40	7 346 07	535	1/40
23	523	1/40	89	-	1/40	85	-	1/40	04	-	1/22	50	-	5/30	10	-	1/40
26	527	1/40	90	527	1/22				05	-	1/40	51	-	5/30	12	-	1/40
29	-	1/22	91	516	1/40	86	-	1/25	07	-	1/40	56	-	1/40	14	-	1/40
30	526	1/40	92	-	1/40	87	-	1/25	09	-	1	57	-	1/40	19	538	1/40
31	-	1/40	93	-	1/22	88	516	1/40	10	529	1/40	60	541	5/30	23	535	1/40
32	-	1/40	94	-	1/22	90	-	1/25	12	-	1/40	61	-	5/30	26	538	1
33	-	1/40	95	527	1/40	91	542	1/35	16	-	1/40	65	-	5/30	29	-	1/22
34	-	1/40	96	-	1/22	92	-	1/35	19	533	1/40	70	-	5/30	32	-	1
35	-	1/40				93	-	1/20	21	529	1/22	71	-	5/30	34	-	1/40
37	-	1/40	7 313 31	522	1/40	94	-	1/20	23	-	1/40	75	-	5/30	37	-	1/40
40	524	1/40	32	-	1/40				26	533	1/40	88	-	5/30	40	536	1/40
41	-	1/40	56	523	1/40	7 332 00	528	1/40	29	532	1/22	89	-	5/30	41	-	1/40
50	-	1/40	57	-	1/40	01	-	1/40	30	-	1/40	91	516	5/30	43	-	1/40
51	-	1/40	82	543	1/40	02	-	1/40	31	-	1/40	92	-	5/30	46	535	1/40
52	527	1/40	83	-	1/40	03	-	1/40	32	-	1/40	93	-	5/30	47	-	1/40
54	524	1/40	91	542	1/35	04	-	1/22	33	-	1/40	94	-	5/30	50	536	1/40
56	-	1/40	92	-	1/35	05	-	1/40	34	-	1/40	95	540	5/100	51	-	1/40
57	-	1/40	93	-	1/20	07	-	1/40	35	-	1/40	96	-	5/110	52	539	1/40
60	525	1/40	94	-	1/20	09	-	1/40	37	-	1/40	97	541	1/22	54	536	1
61	-	1/40				10	529	1/40	40	530	1/40	98	-	1/22	56	-	1/40
65	-	1/40	7 330 00	528	1/40	12	-	1/40	41	-	1/40				57	-	1/40
68	-	1/40	01	-	1/40	16	-	1/40	43	-	1/40	7 339 82	543	1/40	59	537	1/40
69	-	1/40	02	-	1/40	19	533	1/40	50	-	1/40	83	-	1/40	60	-	1/40
70	-	1/22	03	-	1/40	21	529	1/22	51	-	1/40	84	-	1/40	61	-	1/40
71	-	1/22	04	-	1/22	22	-	1/40	52	533	1/40	85	-	1/40	65	-	1/40
75	-	1/22	05	-	1/40	23	-	1/40	54	530	1/40	86	-	1/25	69	-	1/40
85	-	1/40	07	-	1/40	26	533	1/40	56	-	1/40	87	-	1/25	70	-	1/22
86	-	1/22	09	-	1/40	29	532	1/22	57	-	1/40	91	542	1/35	71	-	1/22
89	-	1/40	10	529	1/40	30	-	1/40	59	531	1/40	92	-	1/35	75	-	1/22
90	527	1/22	12	-	1/40	31	-	1/40	60	-	1/40	93	-	1/20	89	-	1/40
91	516	1/40	16	-	1/40	32	-	1/40	61	-	1/40	94	-	1/20	90	538	1/10
92	-	1/40	19	533	1/40	33	-	1/40	65	-	1/40				91	516	1/40
93	-	1/22	21	529	1/22	34	-	1/40	68	-	1	7 341 90	539	1/40	92	-	1/40
94	-	1/22	22	-	1/40	35	-	1/40	69	-	1/40	98	-	1	93	-	1/22
95	527	1/40	23	-	1/40	37	-	1/40	70	-	1/22	99	-	1	94	-	1/22
96	-	1/22	26	533	1/40	40	530	1/40	71	-	1/22				95	539	1/16
			29	532	1/22	41	-	1/40	74	-	1/22	7 342 07	535	1	96	-	1/8
7 311 31	522	1/40	30	-	1/40	42	-	1/40	75	-	1/22	10	-	1			
32	-	1/40	31	-	1/40	43	-	1/40	85	-	1/40	12	-	1/40	7 347 31	535	1/40
56	523	1/40	32	-	1/40	50	-	1/40	86	-	1/22	16	-	1	32	-	1/40
57	-	1/40	33	-	1/40	51	-	1/40	89	-	1/40	19	538	1	33	-	1/40
82	543	1/40	34	-	1/40	52	533	1/40	90	533	1/22	23	535	1	34	-	1/22
83	-	1/40	35	-	1/40	54	530	1/40	91	516	1/40	26	538	1	82	543	1/20
91	542	1/35	37	-	1/40	56	-	1/40	92	-	1/40	29	-	1/22	83	-	1/20
92	-	1/35	40	530	1/40	57	-	1/40	93	-	1/22	32	-	1/40	91	542	1/16
93	-	1/20	41	-	1/40	59	531	1/40	94	-	1/22	37	-	1/40	92	-	1/16
94	-	1/20	42	-	1/40	60	-	1/40	95	533	1/40	40	536	1/40	93	-	1/8
			43	-	1/40	61	-	1/40	96	-	1/22	41	-	1/40	94	-	1/8
7 312 00	522	1/40	50	-	1/40	65	-	1/40	97	532	1/22	43	-	1/40			
01	-	1/40	51	-	1/40	68	-	1/40	98	-	1/22	46	535	1/40	7 350 30	545	10/220
02	-	1/40	52	533	1/40	69	-	1/40				47	-	1/40	60	-	10/220
03	-	1/40	54	530	1/40	70	-	1/22	7 335 31	528	1/40	50	536	1/40	62	-	10/220
04	-	1/22	56	-	1/40	71	-	1/22	32	-	1/40	51	-	1			
05	-	1/40	57	-	1/40	74	-	1/22	56	-	1/40	52	539	1	7 351 30	545	10/220
07	-	1/40	59	531	1/40	75	-	1/22	57	-	1/40	54	536	1/40	60	-	10/220
09	523	1/40	60	-	1/40	85	-	1/40	80	542	1	56	-	1/40	62	-	10/220
10	-	1/40	61	-	1/40	86	-	1/22	81	-	1	57	-	1/40			
12	-	1/40	65	-	1/40	89	-	1/40	82	543	1/40	59	537	1	7 352 56	545	10/100
16	-	1/40	68	-	1/40	90	533	1/22	83	-	1/40	60	-	1/40	65	-	10/220
19	527	1/40	69	-	1/40	91	516	1/40	84	-	1/40	61	-	1/40			
23	523	1/40	70	-	1/22	92	-	1/40	85	-	1/40	65	-	1/40	7 353 56	545	10/100
26	527	1/40	71	-	1/22	93	-	1/22	86	-	1/25	69	-	1	65	-	10/220
29	-	1/22	74	-	1/22	94	-	1/22	87	-	1/25	70	-	1/22			
30	526	1/40	75	-	1/22	95	533	1/40	89	-	1	71	-	1/22	7 354 00	545	10/220
31	-	1/40	85	-	1/40	96	-	1/22	91	542	1/35	75	-	1	01	-	10/220
32	-	1/40	86	-	1/22	97	532	1/22	92	-	1/35	77	-	1	03	-	10/220
33	-	1/40	88	-	1/40	98	-	1/22	93	-	1/20	79	-	1	05	-	10/220
34	-	1/40	89	-	1/40				94	-	1/20	89	-	1	06	-	10/220
35	-	1/40	90	533	1/22	7 333 31	528	1/40	7 338 00	540	5/30	90	538	1/10	07	-	10/220
37	-	1/40	91	516	1/40	32	-	1/40	01	-	5/30	91	516	1/40	10	-	10/220
40	524	1/40	92	-	1/40	56	-	1/40	02	-	5/30	92	-	1/40	11	-	10/220
41	-	1/40	93	-	1/22	57	-	1/40	03	-	5/30	93	-	1/22	12	-	10/220
50	-	1/40	94	-	1/22	80	542	1/35	05	-	5/30	94	-	1/22	13	-	10/220
51	-	1/40	95	533	1/40	81	-	1	10	-	5/30	95	539	1/16	14	-	10/220
52	527	1/40	96	-	1/22	82	543	1/40	12	-	5/30	96	-	1	15	-	10/220
54	524	1/40	97	532	1/22	83	-	1/40	16	-	5/30				16	-	10/220
56	-	1/40	98	-	1/22	84	-	1/40	19	-	5/30	7 343 31	535	1/40	17	-	10/220
57	-	1/40				85	-	1/40	21	-	5/15	32	-	1/40	18	-	10/220
60	525	1/40	7 331 31	528	1/40	86	-	1/25	30	541	5/30	33	-	1/40	20	-	10/220
61	-	1/40	32	-	1/40	87	-	1/25	31	-	5/30	34	-	1/22	21	-	10/220
65	-	1/40	33	-	1/40	91	542	1/35	32	-	5/30	82	543	1/20	22	-	10/220
68	-	1/40	56	-	1/40	92	-	1/35	33	-	5/30	83	-	1	23	-	10/220
69	-	1/40	57	-	1/40	93	-	1/20	34	-	5/30	91	542	1/16	24	-	10/220
70	-	1/22	80	542	1/35	94	-	1/20	35	-	5/30	92	-	1/16	25	-	10/220

**Bold pack quantities:** minimum quantities to be ordered. **Red catalogue number:** new products

Cat.Nos	Page N°	Pack	Cat.Nos	Page N°	Pack	Cat.Nos	Page N°	Pack	Cat.Nos	Page N°	Pack	Cat.Nos	Page N°	Pack	Cat.Nos	Page N°	Pack
7 354 36	545	20/440	<b>7 700 20</b>	465	1/100	<b>7 702 11</b>	458	10/100	7 703 73	465	2/40	7 711 68	477	1/40	7 713 40	472	10/100
40	-	10/100	60	454	1/10	12	452	10/100	74	-	1/20	69	-	1/40	41	478	1/40
41	-	10/100	61	-	1/10	13	-	10/100	75	-	1/20	70	-	1/40	44	475	10/100
46	-	1/40	62	-	1/10	14	453	10/100	76	-	10/100				45	477	1/40
47	-	1/40	65	461	1/10	15	-	10/100	77	-	2/40	7 712 01	482	5/50	46	475	10/100
48	-	1/50	66	-	1/10	16	-	10/100	91	-	10/100	02	-	2/20	48	-	10/100
50	-	1/40	67	-	1/10	17	-	10/100	92	-	10/100	03	483	2/20	53	479	1/40
51	-	1/40	68	-	1/10	18	-	1/10	93	-	2/40	04	-	1/20	54	478	1/40
74	516	10/60	69	-	1/10	19	458	10/100	94	-	1/20	05	482	1/20	57	477	1/40
76	-	15/90	70	-	1/10	23	457	10/100	95	-	1/20	06	-	2/20	60	-	1/40
81	542	10/200	71	-	1/10	26	454	1/10	96	-	10/100	07	483	2/20	61	478	1/40
82	-	10/120	74	454	1/10	27	-	1/10	97	-	2/40	08	-	1/20	62	472	10/100
90	-	10/200	80	456	10/100	28	-	1/10				09	-	1/20	63	-	10/100
91	-	10/200	82	457	1/10	30	456	10/100	<b>7 704 10</b>	455	10/100	10	475	10/100	64	-	10/100
92	-	10/120	83	-	1/10	31	-	10/100	<b>20</b>	465	10/100	11	476	1/40	66	480	1/40
93	543	10/100	84	-	1/10	32	-	10/100	<b>70</b>	459	1/10	12	-	10/100	68	477	1/40
95	542	10/400	85	-	1/10	33	-	10/100	<b>71</b>	465	10/100	15	-	1/40	72	480	1/40
96	-	10/220	89	454	1/10	34	454	10/100	<b>72</b>	-	10/100	17	477	1/40	73	-	1/40
			90	458	10/100	35	-	1/10	<b>73</b>	-	2/40	18	-	1/40	74	478	1/40
			91	454	1/10	38	456	10/100	<b>74</b>	-	1/20	19	475	10/100	75	480	1/40
7 355 00	545	10/220	92	452	10/100	39	-	10/100	<b>75</b>	-	1/20	20	481	10/100	76	-	1/40
01	-	10/100	<b>93</b>	454	1	42	-	10/100	<b>76</b>	-	10/100	21	-	1/40	77	478	10/100
03	-	10/220	97	452	10/100	43	-	10/100	<b>77</b>	-	2/40	22	-	1/40	78	473	1/10
05	-	10/220	98	-	10/100	44	-	10/40	91	-	10/100	24	472	5/50	79	476	1/40
06	-	10/220	99	453	10/100	45	-	10/40	92	-	10/100	26	481	10/100	84	480	1/40
07	-	10/220				46	-	10/100	93	-	2/40	30	472	5/50	85	478	1/40
10	-	10/220	7 701 00	460	5/30	47	-	10/100	94	-	1/20	31	-	5/50	86	477	1/40
11	-	10/220	01	452	10/100	<b>51</b>	463	10/100	95	-	1/20	33	-	5/50	87	-	1/40
12	-	10/220	02	-	10/100	<b>52</b>	-	10/100	96	-	10/100	34	475	1/40	88	-	1/40
13	-	10/220	03	453	10/100	<b>53</b>	-	10/100	97	-	2/40	39	472	10/100	95	479	1/40
14	-	10/220	04	454	1/10	<b>54</b>	-	10/100				40	-	10/100	96	481	1/40
15	-	10/220	05	452	10/100	<b>55</b>	-	5/50	7 710 01	482	10/100	41	478	1/60			
16	-	10/220	06	-	10/100	<b>56</b>	-	5/50	02	-	10/100	44	475	10/100	7 714 01	482	5/50
17	-	10/220	07	-	10/100	<b>57</b>	-	10/100	03	-	2/20	45	477	1/40	02	-	2/20
18	-	10/220	08	-	10/100	60	454	1/10	04	483	1/20	46	475	10/100	03	-	2/20
20	-	10/220	10	-	10/100	61	-	1/10	05	-	1/20	48	-	10/100	04	483	1/20
21	-	10/220	11	453	10/100	62	-	1/10	06	482	10/100	53	479	1/40	05	-	1/20
22	-	10/220	12	-	10/100	66	461	1/10	07	-	2/20	54	478	1/40	06	482	2/20
23	-	10/220	13	-	10/100	67	-	1/10	08	483	1/20	57	477	1/40	07	-	2/20
24	-	10/220	14	454	1/10	68	-	1/10	09	-	1/20	60	-	1/40	08	483	1/20
25	-	10/220	15	453	10/100	<b>70</b>	459	1/10	10	476	10/100	61	478	1/40	09	-	1/20
36	-	20/440	16	458	10/100	74	454	1/10	11	-	10/100	62	472	10/100	10	475	10/100
40	-	10/100	19	453	1/10	80	456	10/100	12	-	10/100	63	-	10/100	11	476	1/40
41	-	10/100	20	458	10/100	82	457	1/10	13	482	5/50	64	-	10/100	12	-	10/100
46	-	1/40	21	-	10/100	83	-	1/10	14	-	2/20	66	480	1/40	15	-	1/40
47	-	1/40	22	-	10/100	84	-	1/10	15	-	2/20	68	477	1/40	17	477	1/40
48	-	1/50	23	-	10/100	85	-	1/10	20	474	10/100	72	480	1/40	18	-	1/40
50	-	1/40	24	457	10/100	89	454	1/10	21	-	10/100	73	-	1/40	19	475	10/100
51	-	1/40	25	452	10/100	90	460	5/30	22	-	10/100	74	478	1/40	20	481	10/100
			26	-	10/100	91	454	1/10	23	-	10/100	75	480	1/40	21	-	1/40
			27	460	5/30				24	472	10/100	76	-	1/40	22	-	1/40
7 364 00	542	10/60	28	452	10/100	<b>7 703 01</b>	465	1/100	26	474	1/10	77	478	10/100	24	472	5/50
01	-	5/30	29	455	10/100	<b>02</b>	-	1/100	27	-	10/100	78	473	1/10	26	481	10/100
06	521	10/60	30	-	10/100	<b>03</b>	-	1	28	-	1/10	79	476	1/40	30	472	5/50
07	-	10/40	31	-	10/100	<b>04</b>	-	1/20	29	472	10/100	84	480	1/40	31	-	5/50
10	-	5/30	32	-	10/100	<b>05</b>	-	1/20	30	-	5/50	85	478	1/40	33	-	5/50
11	-	5/20	33	-	10/100	<b>06</b>	-	1/100	31	-	5/50	86	477	1/40	34	475	1/40
13	-	5/30	34	-	10/100	<b>07</b>	-	1	33	-	5/50	87	-	1/40	39	472	10/100
18	543	1/6	35	-	10/100	<b>11</b>	-	10/100	34	475	10/100	88	-	1/40	40	-	10/100
22	-	1/6	36	-	10/100	<b>12</b>	-	10/100	39	472	10/100	95	479	1/40	41	478	1/60
28	-	1/6	37	-	10/100	<b>13</b>	-	2/40	40	-	10/100	96	481	1/40	44	475	10/100
32	-	1/6	38	456	10/100	<b>14</b>	-	1/20	44	-	10/100				45	477	1/40
			39	-	10/100	<b>15</b>	-	1/20	45	-	10/100	7 713 01	482	5/50	46	475	10/100
7 395 00	544	10/220	41	-	1/10	<b>16</b>	-	10/100	46	-	10/100	02	-	2/20	48	-	10/100
01	-	10/220	42	455	10/100	<b>17</b>	-	2/40	47	481	10/100	03	-	2/20	53	479	1/40
03	-	10/220	45	452	10/100	<b>31</b>	-	1/100	48	472	10/100	04	483	1/20	54	478	1/40
04	-	10/220	46	460	10/100	<b>32</b>	-	1/100	62	-	10/100	05	-	1/20	57	477	1/40
07	-	10/220	47	-	10/100	<b>33</b>	-	1/40	63	-	10/100	06	482	2/20	60	-	1/40
08	-	10/220	48	452	10/100	<b>34</b>	-	1/20	64	-	10/100	07	-	2/20	61	478	1/40
			49	-	10/100	<b>35</b>	-	1/20	68	477	1/40	08	483	1/20	62	472	10/100
7 396 79	544	10/220	50	460	10/100	<b>36</b>	-	1/100	72	480	10/100	09	-	1/20	63	-	10/100
80	-	10/220	51	465	10/100	<b>37</b>	-	1/40	73	-	10/100	10	475	10/100	64	-	10/100
82	-	10/220	52	-	10/100	<b>41</b>	-	1/100	74	478	10/100	11	476	1/40	66	480	1/40
83	-	10/220	53	-	2/40	<b>42</b>	-	1/100	79	476	10/100	12	-	10/100	68	477	1/40
92	-	10/220	54	-	1/20	<b>43</b>	-	1/40	86	477	1/40	15	-	1/40	72	480	1/40
			55	-	1/20	<b>44</b>	-	1/20	87	-	1/40	17	477	1/40	73	-	1/40
			56	-	10/100	<b>45</b>	-	1/20	88	-	1/40	18	-	1/40	74	478	1/40
7 398 21	544	10/220	57	-	2/40	<b>46</b>	-	1/100	96	474	10/50	19	475	10/100	75	480	1/40
23	-	10/220	80	460	10/100	<b>47</b>	-	1/40	97	-	5/25	20	481	10/100	76	-	1/40
24	-	1	91	-	5/30	<b>51</b>	-	10/100	98	-	1/10	21	-	1/40	77	478	10/100
28	-	10/220	94	458	5/50	<b>52</b>	-	10/100				22	-	1/40	78	473	1/10
33	-	1	96	-	10/100	<b>53</b>	-	2/40	7 711 50	474	10/100	24	472	5/50	79	476	1/40
39	-	1	97	-	10/100	<b>54</b>	-	1/20	51	-	10/100	26	481	10/100	84	480	1/40
61	-	10/220				<b>55</b>	-	1/20	52	-	10/100						

Cat.Nos	Page N°	Pack	Cat.Nos	Page N°	Pack	Cat.Nos	Page N°	Pack	Cat.Nos	Page N°	Pack	Cat.Nos	Page N°	Pack	Cat.Nos	Page N°	Pack								
7 714	95	479	1/40	7 719	31	482	1/25	7 741	32	456	10/100	7 743	10	452	10/100	7 744	32	455	10/100	7 757	90	471	10/100		
	96	481	1/40		32	-	1/20		33	-	10/100		11	453	10/100		33	-	10/100		91	-	10/100		
					33	-	1/15		34	454	10/100		12	-	10/100		34	-	10/100		98	470	10/100		
7 715	01	482	5/50		34	483	1/20		35	-	1/10		13	-	10/100		35	-	10/100		99	-	10/100		
	02	-	2/20		35	-	1/20		38	456	10/100		14	454	1/10		36	-	10/100						
	03	-	2/20		36	482	1/20		39	-	10/100		15	453	10/100		37	-	10/100		7 758	00	473	10/400	
	04	483	1/20		37	-	1/15		42	-	10/100		16	458	10/100		38	456	10/100			01	466	10/100	
	05	-	1/20		38	483	1/20		43	-	10/100		19	453	1/10		39	-	10/100			02	-	10/100	
	06	482	2/20		39	-	1/20		44	-	10/40		20	458	10/100		41	-	1/10			03	-	10/100	
	07	-	2/20		41	482	1/25		45	-	10/40		21	-	10/100		42	455	10/100			05	-	10/100	
	08	483	1/20		42	-	1/20		46	-	10/100		22	-	10/100		45	452	10/100			06	-	10/100	
	09	-	1/20		43	-	1/15		47	-	10/100		23	-	10/100		46	460	10/100			07	-	10/100	
	10	475	10/100		44	483	1/20		51	465	10/100		24	457	10/100		47	-	10/100			08	-	10/100	
	11	476	1/40		45	-	1/20		52	-	10/100		25	452	10/100		48	452	10/100			09	467	1/10	
	12	-	10/100		46	482	1/20		53	-	2/40		26	-	10/100		49	-	10/100			10	468	1/10	
	15	-	1/40		47	-	1/15		54	-	1/20		27	458	10/100		50	460	10/100			11	-	10/100	
	17	477	1/40		48	483	1/20		55	-	1/20		28	452	10/100		51	465	10/100			13	-	10/100	
	18	-	1/40		49	-	1/20		56	-	10/100		29	455	10/100		52	-	10/100			15	469	1/10	
	19	475	10/100		51	482	1/25		57	-	2/40		30	-	10/100		53	-	2/40			16	468	10/100	
	20	481	10/100		52	-	1/20		60	454	1/10		31	-	10/100		54	-	1/20			17	-	10/100	
	21	-	1/40		53	-	1/15		61	-	1/10		32	-	10/100		55	-	1/20			18	-	1/10	
	22	-	1/40		54	483	1/20		62	-	1/10		33	-	10/100		56	-	10/100			19	467	1/10	
	24	472	5/50		55	-	1/20		65	461	1/10		34	-	10/100		57	-	2/40			20	466	10/100	
	26	481	10/100		56	482	1/20		66	-	1/10		35	-	10/100		61	-	10/100			22	-	10/100	
	30	472	5/50		57	-	1/15		67	-	1/10		36	-	10/100		62	-	10/100			23	470	10/100	
	31	-	5/50		58	483	1/20		68	-	1/10		37	-	10/100		63	-	2/40			25	466	1/10	
	33	-	5/50		59	-	1/20		70	459	1/10		38	456	10/100		64	-	1/20			27	-	1/10	
	34	475	1/40		61	482	1/25		74	454	1/10		39	-	10/100		65	-	1/20			28	470	10/100	
	39	472	10/100		62	-	1/20		80	456	10/100		41	-	1/10		66	-	10/100			30	-	10/100	
	40	-	10/100		63	-	1/15		82	457	1/10		42	455	10/100		67	-	2/40			36	471	10/100	
	41	478	1/40		64	483	1/20		83	-	1/10		45	452	10/100		80	460	10/100			37	-	10/100	
	44	475	10/100		65	-	1/20		84	-	1/10		46	460	10/100							38	-	10/100	
	45	477	1/40		66	482	1/20		85	-	1/10		47	-	10/100		7 756	00	466	10/100		44	468	10/100	
	46	475	10/100		67	-	1/15		89	454	1/10		48	452	10/100		01	-	10/100			45	466	10/100	
	48	-	10/100		68	483	1/20		91	-	1/10		49	-	10/100		02	-	10/100			46	468	10/100	
	53	479	1/40		69	-	1/20		92	452	10/100		50	460	10/100		04	-	10/100			47	470	10/100	
	54	478	1/40		71	482	1/25		97	-	10/100		51	465	10/100		05	-	10/100			48	471	10/100	
	57	477	1/40		72	-	1/20		98	-	10/100		52	-	10/100		06	-	10/100			49	-	10/100	
	60	-	1/40		73	-	1/15		99	453	10/100		53	-	2/40		08	-	10/100			52	474	10/100	
	61	478	1/40		74	483	1/20						54	-	1/20		09	-	10/100			58	469	1/10	
	62	472	10/100		75	-	1/20		7 742	01	452	10/100		55	-	1/20		52	468	1/10			67	-	1/10
	63	-	10/100		76	482	1/20		02	460	5/50		56	-	10/100		53	-	1/10			68	-	1/10	
	64	-	10/100		77	-	1/15		03	453	10/100		57	-	2/40		54	-	1/10			69	466	10/100	
	66	480	1/40		78	483	1/20		04	-	10/100		70	460	5/50		55	466	1/10			85	470	10/100	
	68	477	1/40		79	-	1/20		05	-	10/100		71	-	5/50		56	-	1/10			90	474	10/100	
	72	480	1/40		81	482	1/25		06	452	10/100		72	458	10/100		57	-	1/10			91	-	10/100	
	73	-	1/40		82	-	1/20		07	460	5/50		73	-	10/100		61	467	1/10			92	-	10/100	
	74	478	1/40		83	-	1/15		10	-	10/100		80	460	10/100		62	-	1/10			93	-	10/100	
	75	480	1/40		84	483	1/20		12	452	10/100		90	-	5/50		80	471	10/100			94	-	10/100	
	76	-	1/40		85	-	1/20		13	-	10/100		91	-	5/50		81	466	10/100			95	-	10/100	
	77	478	10/100		86	482	1/20		14	453	10/100		92	-	5/50		83	467	1/20			96	-	10/100	
	78	473	1/10		87	-	1/15		15	-	10/100		93	-	5/50		84	469	1/10			97	-	10/100	
	79	476	1/40		88	483	1/20		16	-	10/100		94	458	5/50		85	-	1/10			98	-	10/100	
	84	480	1/40		89	-	1/20		17	-	10/100		95	-	5/50		86	-	1/10			99	-	10/100	
	85	478	1/40		90	482	1/25		18	-	1/10		96	-	10/100		87	-	1/10						
	86	477	1/40		91	-	1/20		19	458	10/100		97	-	10/100		88	-	1/10			7 759	00	474	20/200
	87	-	1/40		92	-	1/15		20	-	10/100		98	-	10/100		89	-	1/10			01	468	1/10	
	88	-	1/40		93	-	1/20		21	-	10/100		99	-	10/100		90	-	1/10			03	-	1/10	
	95	479	1/40		94	-	15		22	-	10/100						91	-	1/10			16	471	10/100	
	96	481	1/40		95	-	1/25		23	457	10/100		7 744	00	460	5/50		92	-	1/10			20	-	10/100
					96	-	1/20		26	454	1/10		01	452	10/100		93	-	1/10			21	-	10/100	
7 719	01	482	1/25		97	-	1/15		27	-	1/10		02	-	10/100		94	-	1/10			24	474	10/100	
	02	-	1/20		98	-	1/20		28	-	1/10		03	453	10/100		95	-	1/10			25	472	1/10	
	03	-	1/15		99	-	1/15		30	456	10/100		04	454	1/10		96	467	1/10			29	474	10/100	
	04	483	1/20						31	-	10/100		05	452	10/100		97	-	1/10			30	471	10/100	
	05	-	1/20		7 741	01	452	10/100		32	-	10/100		06	-	10/100		98	-	1/10			37	470	10/100
	06	482	1/20		03	453	10/100		33	-	10/100		07	-	10/100		99	-	1/10			38	-	10/100	
	07	-	1/15		04	-	10/100		34	454	10/100		08	-	10/100							39	-	10/100	
	08	483	1/20		05	-	10/100		35	-	1/10		10	-	10/100		7 757	09	469	1/10		40	473	10/100	
	09	-	1/20		06	452	10/100		38	456	10/100		11	453	10/100		10	-	1/10			41	-	1/10	
	11	482	1/25		10	455	10/100		39	-	10/100		12												

Cat.Nos	Page N°	Pack	Cat.Nos	Page N°	Pack	Cat.Nos	Page N°	Pack	Cat.Nos	Page N°	Pack	Cat.Nos	Page N°	Pack	Cat.Nos	Page N°	Pack
7 759 92	474	50/500	7 770 61	478	1/40	7 821 00	436	<b>5/50</b>	7 821 46	437	50	7 823 96	441	5	7 824 41	438	<b>1/20</b>
99	460	1/40	66	480	10/100	01	-	50	47	-	50	97	-	<b>1/5</b>	42	-	10
7 761 31	460	10/50	75	-	10/100	02	-	50	50	436	20/200	98	-	50	43	-	10
34	-	10/100	76	-	10/100	03	-	50	54	437	20/200	99	-	5/50	44	439	20
35	-	10/100	78	473	10/100	04	-	50	57	-	20/200				45	-	20/200
81	-	10/50	79	481	10/100	05	-	20/200	<b>59</b>	436	20/200	7 824 00	438	20/200	46	-	20
84	-	10/100	84	480	10/100	06	-	20/200				02	-	20/200	47	-	20
85	-	10/100	85	478	10/100	07	-	20/200	7 823 60	441	10	04	-	20/200	48	438	10/100
7 770 10	475	10/100	95	479	10/100	10	-	50	61	-	<b>1/10</b>	05	-	20/200	<b>49</b>	439	10/100
11	476	10/100	96	481	10/100	11	437	20/200	62	-	<b>1/10</b>	<b>06</b>	-	20	50	438	20
12	-	10/100				12	436	30	63	-	<b>1/10</b>	10	-	20/200	<b>51</b>	439	20/200
15	-	10/100	7 810 45	476	10/100	13	437	30	64	-	10	11	-	20/200	53	438	10/100
17	477	10/100	50	467	1/10	14	-	50	65	-	<b>1/10</b>	12	-	10/100	54	439	20
18	-	10/100	59	477	1/40	15	-	50	66	-	10	13	-	10/100	57	-	5/50
19	475	10/100	7 812 25	481	1	16	-	50	71	-	5	14	439	20/200	94	440	<b>1/2</b>
20	481	10/100	45	476	1/40	17	-	50	72	-	<b>1/5</b>	15	-	20/200	95	-	20/200
21	-	10/100	50	467	1/10	20	436	20/200	<b>73</b>	-	10	16	-	<b>1/20</b>	96	-	2
22	-	10/100	59	477	1/40	24	437	20/200	<b>74</b>	-	5	17	-	20/200	97	-	2
24	-	10/100	7 813 25	481	1	27	-	50/200	75	-	<b>1/10</b>	18	438	10/100			
25	-	1	45	476	1/40	<b>29</b>	436	20/200	76	-	5/50	<b>19</b>	439	10/100			
26	-	10/100	50	467	1/10	30	-	50	77	-	<b>1/5</b>	20	438	20/200			
29	-	10/200	59	477	1/40	31	-	50	79	-	5/50	<b>21</b>	439	20/200			
34	-	10/100				32	-	50	80	-	10	23	438	10/100	9 000 28	087	1
41	478	1/60	7 814 25	481	1	33	-	50	81	-	<b>1/10</b>	24	439	20/200			
42	481	10/100	45	476	1	34	-	50	82	-	<b>1/10</b>	25	440	10/100	<b>9 003 86</b>	248	1
44	475	10/100	50	467	1/10	35	-	20/200	83	-	10	26	439	20/200	<b>87</b>	-	1
46	-	10/100	59	477	1/40	36	-	20/200	84	-	<b>1/10</b>	<b>28</b>	-	20/200	<b>88</b>	-	1
48	-	10/100				37	-	20/200	85	-	10	29	-	<b>1/10</b>	<b>89</b>	-	1
53	479	1/40	7 815 25	481	1	40	-	50	86	-	10	30	438	20/200	<b>90</b>	-	1
54	478	10/100	45	476	1	41	437	50	91	-	<b>1/5</b>	32	-	<b>1/20</b>	<b>91</b>	-	1
57	477	1/40	50	467	1/10	42	436	30	92	-	5/50	34	-	20/200	<b>92</b>	-	1
60	-	1/40	59	477	1/40	43	437	10/100	<b>93</b>	-	<b>1/10</b>	35	-	<b>1/20</b>	<b>93</b>	-	1
						44	-	50	<b>94</b>	-	5	<b>36</b>	-	20	<b>94</b>	-	1
						45	-	50	95	-	10	40	-	20	<b>95</b>	-	1

# Alpes Technologies product

Cat.Nos	Page No	Pack	Cat.Nos	Page No	Pack	Cat.Nos	Page No	Pack	Cat.Nos	Page No	Pack
ALPTEC12B	103	1	M50040	100	1	MS.R32040.189	101	1	SAH-0.86-80.8	104	1
ALPTEC4	-	1	M5040	-	1	MS.R36040.189	-	1	SAH-1.35-94.2	-	1
ALPTEC6	-	1	M52.540	-	1	MS.R40040.189	-	1	SAH-1.73-40.4	-	1
B10040	97	1	M55040	-	1	MS.R44040.189	-	1	SAH-1-125.6	-	1
B1040	-	1	M60040	-	1	MS.R48040.189	-	1	SAH-2.02-62.8	-	1
B12540	-	1	M6040	-	1	MS.R52040.189	-	1	SAH-3.45 -20.2	-	1
B15040	-	1	M67.540	-	1	MS.R56040.189	-	1	SAH-4.05 -28.9	-	1
B1540	-	1	M67540	-	1	MS.R60040.189	-	1	SAH-4.31-16.2	-	1
B17540	-	1	M75040	-	1	MS.R64040.189	-	1	SAH-8.1-15.7	-	1
B2040	-	1	M7540	-	1	MS.R72040.189	-	1	V10040CB	96	1
B2540	-	1	M82540	-	1	MS.R80040.189	-	1	V1040CB	-	1
B3040	-	1	M87.540	-	1	MS10040.189	-	1	V12.540CB	-	1
B4040	-	1	M90040	-	1	MS12540.189	-	1	V12540CB	-	1
B5040	-	1	MH10040	-	1	MS15040.189	-	1	V1540CB	-	1
B6040	-	1	MH1040	-	1	MS20040.189	-	1	V2.540CB	-	1
B7540	-	1	MH112.540	-	1	MS22540.189	-	1	V2040CB	-	1
B9040	-	1	MH12540	-	1	MS25040.189	-	1	V2540CB	-	1
BH10040	-	1	MH15040	-	1	MS27540.189	-	1	V3040CB	-	1
BH1040	-	1	MH1540	-	1	MS30040.189	-	1	V3540CB	-	1
BH12540	-	1	MH17540	-	1	MS35040.189	-	1	V4040CB	-	1
BH15040	-	1	MH20040	-	1	MS37540.189	-	1	V5040CB	-	1
BH1540	-	1	MH2040	-	1	MS45040.189	-	1	V540CB	-	1
BH17540	-	1	MH22540	-	1	MS52540.189	-	1	V6040CB	-	1
BH2040	-	1	MH25040	-	1	MS60040.189	-	1	V7.540CB	-	1
BH2540	-	1	MH2540	-	1	MS67540.189	-	1	V7540CB	-	1
BH3040	-	1	MH27540	-	1	MS75040.189	-	1	V9040CB	-	1
BH4040	-	1	MH30040	-	1	MS7540.189	-	1	VH10040CB	-	1
BH5040	-	1	MH3040	-	1	P12.512.540	98	1	VH1040CB	-	1
BH6040	-	1	MH35040	-	1	P12.540	-	1	VH12.540CB	-	1
BH7540	-	1	MH3540	-	1	P252540	-	1	VH12540CB	-	1
BH9040	-	1	MH40040	-	1	P2540	-	1	VH1540CB	-	1
M10040	100	1	MH4040	-	1	P255040	-	1	VH2.540CB	-	1
M1040	-	1	MH45040	-	1	P5040	-	1	VH2040CB	-	1
M112.540	-	1	MH50040	-	1	P7540	-	1	VH2540CB	-	1
M12540	-	1	MH5040	-	1	PH12.512.540	-	1	VH3040CB	-	1
M15040	-	1	MH52.540	-	1	PH12.540	-	1	VH3540CB	-	1
M1540	-	1	MH55040	-	1	PH252540	-	1	VH4040CB	-	1
M17540	-	1	MH60040	-	1	PH2540	-	1	VH5040CB	-	1
M20040	-	1	MH6040	-	1	PH255040	-	1	VH540CB	-	1
M2040	-	1	MH67.540	-	1	PH5040	-	1	VH6040CB	-	1
M22540	-	1	MH67540	-	1	PH7540	-	1	VH7.540CB	-	1
M25040	-	1	MH75040	-	1	R5.2540.189	99	1	VH7540CB	-	1
M2540	-	1	MH7540	-	1	R5.5040.189	-	1	VH8040CB	-	1
M27540	-	1	MH82540	-	1	R5.R4040.189	-	1	VH9040CB	-	1
M30040	-	1	MH87.540	-	1	R7.5040.189	-	1			
M3040	-	1	MH90040	-	1	R7.7540.189	-	1			
M35040	-	1	MS.R12040.189	101	1	R7.R4040.189	-	1			
M3540	-	1	MS.R16040.189	-	1	R7.R8040.189	-	1			
M40040	-	1	MS.R20040.189	-	1	R9.RS7240.189	-	1			
M4040	-	1	MS.R24040.189	-	1	SAH-0.43-161.6	104	1			
M45040	-	1	MS.R28040.189	-	1	SAH-0.58-121.2	-	1			



# MCBs, RCDs & DIN RAIL EQUIPMENT

## MCBs, RCDs, add-on modules & accessories



**NEW**  
**P. 40**  
RX³ MCBs ≤ 63 A  
[4500] & [6000]  
prong type busbar



**NEW**  
**P. 45**  
TX³ MCBs ≤ 63 A  
[6000] & [10000]  
prong & fork  
type busbar



**P. 50**  
DX³ RCB0s ≤ 63 A  
[6000] / 10 kA  
AC, A & Hpi type  
prong & fork type busbar



**P. 57**  
DX³ MCBs ≤ 63 A  
50 kA

## Voltage surge protectors & other control and signalling devices



**P. 62**  
Voltage surge  
protectors

## Time & light sensitive switches



**P. 74**  
Programmable  
time switches with  
digital display

## Dimmers, relays, transformers, power supplies & accessories



**P. 78**  
Remote control  
dimmers

## NEW PRODUCTS 2014



**RX³ MCBs ≤ 63 A**  
[6000] compatible  
with fork & prong type  
busbar  
(p. 41)



**TX³ MCBs ≤ 63 A**  
[6000] compatible  
with prong type busbar  
(p. 44)





**NEW**  
**P. 41**  
RX<sup>3</sup> MCBs ≤ 63 A  
6000 prong & fork  
type busbar

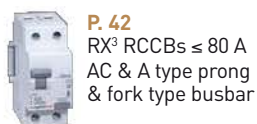

**P. 42**  
RX<sup>3</sup> RCCBs ≤ 80 A  
AC & A type prong  
& fork type busbar



**NEW**  
**P. 44**  
TX<sup>3</sup> MCBs ≤ 63 A  
6000 prong type  
busbar

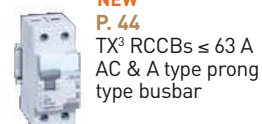

**NEW**  
**P. 44**  
TX<sup>3</sup> RCCBs ≤ 63 A  
AC & A type prong  
type busbar

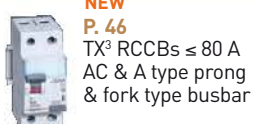

**NEW**  
**P. 46**  
TX<sup>3</sup> RCCBs ≤ 80 A  
AC & A type prong  
& fork type busbar



**P. 46**  
DX-E MCBs ≤ 63 A  
6000 / 6 kA  
prong & fork type  
busbar

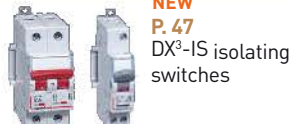

**NEW**  
**P. 47**  
DX<sup>3</sup>-IS isolating  
switches

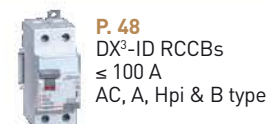

**P. 48**  
DX<sup>3</sup>-ID RCCBs  
≤ 100 A  
AC, A, Hpi & B type



**P. 52**  
DX<sup>3</sup> MCBs ≤ 63 A  
6000 / 10 kA  
prong & fork type  
busbar



**P. 54**  
DX<sup>3</sup> MCBs ≤ 125 A  
10000 / 16 kA  
prong & fork type  
busbar

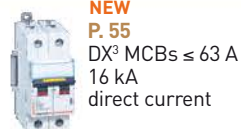

**NEW**  
**P. 55**  
DX<sup>3</sup> MCBs ≤ 63 A  
16 kA  
direct current



**P. 56**  
DX<sup>3</sup> MCBs ≤ 125 A  
25 kA



**P. 58**  
DX<sup>3</sup> add-on  
modules ≤ 125 A  
AC, A & Hpi type



**P. 60**  
DX<sup>3</sup> signalling &  
remote tripping  
auxiliaries



**NEW**  
**P. 61**  
DX<sup>3</sup> motorised  
controls



**NEW**  
**P. 61**  
DX<sup>3</sup> manual  
supply inverter



**P. 66**  
Domestic fuse  
carriers &  
cartridge fuses



**P. 68**  
CX<sup>3</sup> pulse operated  
latching relays



**P. 70**  
CX<sup>3</sup> DIN rail  
power contactors

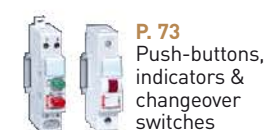

**P. 73**  
Push-buttons,  
indicators &  
changeover  
switches

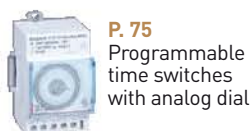

**P. 75**  
Programmable  
time switches  
with analog dial



**NEW**  
**P. 76**  
Microrex Plus 2  
programmable  
time switches



**P. 77**  
Electronic  
time-lug  
switches



**P. 78**  
Light sensitive  
switches



**P. 79**  
Time-delay  
relays



**P. 80**  
Transformers  
buzzers and bells

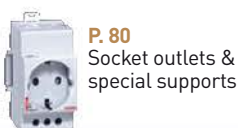

**P. 80**  
Socket outlets &  
special supports



**P. 81**  
Single phase  
power supplies



**DX<sup>3</sup> MCBs ≤ 63 A**  
direct current  
(p. 55)



**Manual supply inverter**  
for DX<sup>3</sup> and TX<sup>3</sup>  
(p. 61)

## MCBs RX<sup>3</sup> 4500

thermal magnetic MCBs from 6 A to 63 A - C curve



## MCBs RX<sup>3</sup> 6000

thermal magnetic MCBs from 6 A to 63 A - C curve

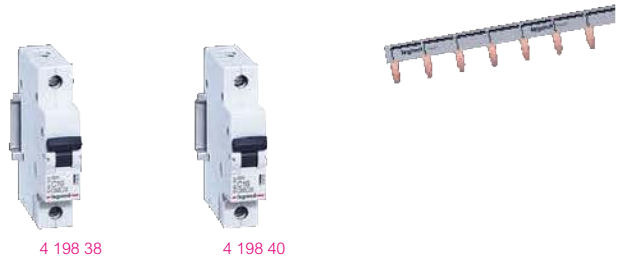
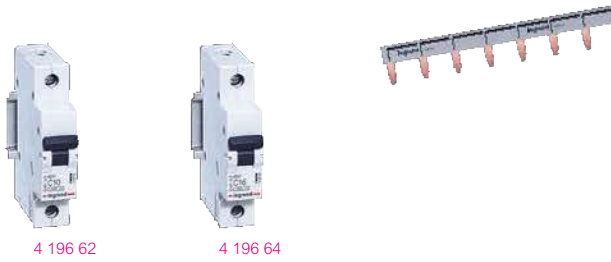

Technical characteristics [see e-catalogue](#)  
Cross reference list old range/new range **p. 43**

Conform to IEC 60898-1  
Do not accept auxiliaries, and add-on modules  
Compatible with prong-type supply busbars  
Breaking capacity:  
[4500] - IEC 60898-1 - 230/400 V~  
4.5 kA - IEC 60947-2 - 230/400 V~  
[6000] - IEC 60898-1 - 127/220 V~  
6 kA - IEC 60947-2 - 127/220 V~

Technical characteristics [see e-catalogue](#)  
Cross reference list old range/new range **p. 43**

Conform to IEC 60898-1  
Do not accept auxiliaries, and add-on modules  
Compatible with prong-type supply busbars  
Breaking capacity:  
[6000] - IEC 60898-1 - 230/400 V~  
6 kA - IEC 60947-2 - 230/400 V~  
[10000] - IEC 60898-1 - 127/220 V~  
10 kA - IEC 60947-2 - 127/220 V~

Pack	Cat.Nos	Nominal rating I <sub>n</sub> (A)	Number of modules
	<b>C curve</b>		
12	4 196 61	6	1
12	4 196 62	10	1
12	4 196 64	16	1
12	4 196 65	20	1
12	4 196 66	25	1
12	4 196 67	32	1
12	4 196 68	40	1
12	4 196 69	50	1
12	4 196 70	63	1

Pack	Cat.Nos	Nominal rating I <sub>n</sub> (A)	Number of modules
	<b>C curve</b>		
12	4 198 37	6	1
12	4 198 38	10	1
12	4 198 40	16	1
12	4 198 41	20	1
12	4 198 42	25	1
12	4 198 43	32	1
12	4 198 44	40	1
12	4 198 45	50	1
12	4 198 46	63	1

Pack	Cat.Nos	Nominal rating I <sub>n</sub> (A)	Number of modules
	<b>C curve</b>		
6	4 196 94	6	2
6	4 196 95	10	2
6	4 196 97	16	2
6	4 196 98	20	2
6	4 196 99	25	2
6	4 197 00	32	2
6	4 197 01	40	2
6	4 197 02	50	2
6	4 197 03	63	2

Pack	Cat.Nos	Nominal rating I <sub>n</sub> (A)	Number of modules
	<b>C curve</b>		
6	4 198 70	6	2
6	4 198 71	10	2
6	4 198 73	16	2
6	4 198 74	20	2
6	4 198 75	25	2
6	4 198 76	32	2
6	4 198 77	40	2
6	4 198 78	50	2
6	4 198 79	63	2

Pack	Cat.Nos	Nominal rating I <sub>n</sub> (A)	Number of modules
	<b>C curve</b>		
4	4 197 05	6	3
4	4 197 06	10	3
4	4 197 08	16	3
4	4 197 09	20	3
4	4 197 10	25	3
4	4 197 11	32	3
4	4 197 12	40	3
4	4 197 13	50	3
4	4 197 14	63	3

Pack	Cat.Nos	Nominal rating I <sub>n</sub> (A)	Number of modules
	<b>C curve</b>		
4	4 198 81	6	3
4	4 198 82	10	3
4	4 198 84	16	3
4	4 198 85	20	3
4	4 198 86	25	3
4	4 198 87	32	3
4	4 198 88	40	3
4	4 198 89	50	3
4	4 198 90	63	3

Pack	Cat.Nos	Nominal rating I <sub>n</sub> (A)	Number of modules
	<b>C curve</b>		
3	4 197 38	6	4
3	4 197 39	10	4
3	4 197 41	16	4
3	4 197 42	20	4
3	4 197 43	25	4
3	4 197 44	32	4
3	4 197 45	40	4
3	4 197 46	50	4
3	4 197 47	63	4

Pack	Cat.Nos	Nominal rating I <sub>n</sub> (A)	Number of modules
	<b>C curve</b>		
3	4 199 14	6	4
3	4 199 15	10	4
3	4 199 17	16	4
3	4 199 18	20	4
3	4 199 19	25	4
3	4 199 20	32	4
3	4 199 21	40	4
3	4 199 22	50	4
3	4 199 23	63	4

## MCBs RX<sup>3</sup> 6000

thermal magnetic MCBs from 6 A to 63 A - B curve



## MCBs RX<sup>3</sup> 6000

thermal magnetic MCBs from 6 A to 63 A - C curve

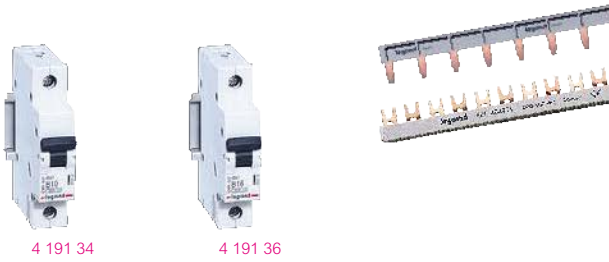

Technical characteristics [see e-catalogue](#)

Technical characteristics [see e-catalogue](#)

Conform to IEC 60898-1  
Do not accept auxiliaries, and add-on modules  
Compatible with prong-type and fork type supply busbars  
Breaking capacity:  
[6000] - IEC 60898-1 - 230/400 V~  
6 kA - IEC 60947-2 - 230/400 V~  
[10000] - IEC 60898-1 - 127/220 V~  
10 kA - IEC 60947-2 - 127/220 V~

Conform to IEC 60898-1  
Do not accept auxiliaries, and add-on modules  
Compatible with prong-type and fork type supply busbars  
Breaking capacity:  
[6000] - IEC 60898-1 - 230/400 V~  
6 kA - IEC 60947-2 - 230/400 V~  
[10000] - IEC 60898-1 - 127/220 V~  
10 kA - IEC 60947-2 - 127/220 V~

Pack	Cat.Nos	Single pole 230/400 V~	
	B curve	Nominal rating I <sub>n</sub> (A)	Number of modules
12	4 191 33	6	1
12	4 191 34	10	1
12	4 191 35	13	1
12	4 191 36	16	1
12	4 191 37	20	1
12	4 191 38	25	1
12	4 191 39	32	1
12	4 191 40	40	1
12	4 191 41	50	1
12	4 191 42	63	1

Pack	Cat.Nos	Single pole 230/400 V~	
	C curve	Nominal rating I <sub>n</sub> (A)	Number of modules
12	4 191 99	6	1
12	4 192 00	10	1
12	4 192 01	13	1
12	4 192 02	16	1
12	4 192 03	20	1
12	4 192 04	25	1
12	4 192 05	32	1
12	4 192 06	40	1
12	4 192 07	50	1
12	4 192 08	63	1

Pack	Cat.Nos	2-pole 230/400 V~	
	B curve	Nominal rating I <sub>n</sub> (A)	Number of modules
6	4 191 55	6	2
6	4 191 56	10	2
6	4 191 57	13	2
6	4 191 58	16	2
6	4 191 59	20	2
6	4 191 60	25	2
6	4 191 61	32	2
6	4 191 62	40	2
6	4 191 63	50	2
6	4 191 64	63	2

Pack	Cat.Nos	2-pole 230/400 V~	
	C curve	Nominal rating I <sub>n</sub> (A)	Number of modules
6	4 192 21	6	2
6	4 192 22	10	2
6	4 192 23	13	2
6	4 192 24	16	2
6	4 192 25	20	2
6	4 192 26	25	2
6	4 192 27	32	2
6	4 192 28	40	2
6	4 192 29	50	2
6	4 192 30	63	2

Pack	Cat.Nos	3-pole 400 V~	
	B curve	Nominal rating I <sub>n</sub> (A)	Number of modules
4	4 191 66	6	3
4	4 191 67	10	3
4	4 191 68	13	3
4	4 191 69	16	3
4	4 191 70	20	3
4	4 191 71	25	3
4	4 191 72	32	3
4	4 191 73	40	3
4	4 191 74	50	3
4	4 191 75	63	3

Pack	Cat.Nos	3-pole 400 V~	
	C curve	Nominal rating I <sub>n</sub> (A)	Number of modules
4	4 192 32	6	3
4	4 192 33	10	3
4	4 192 34	13	3
4	4 192 35	16	3
4	4 192 36	20	3
4	4 192 37	25	3
4	4 192 38	32	3
4	4 192 39	40	3
4	4 192 40	50	3
4	4 192 41	63	3

## RCCBs RX<sup>3</sup>

residual current circuit breakers from 25 A to 80 A - AC and A types



Dimensions **see e-catalogue**

Conform to IEC 61008-1

- AC type : detect AC component faults
  - A type : detect AC and DC component faults
- Compatible with prong-type and fork type supply busbars  
Do not accept auxiliaries

Pack	Cat.Nos	2-pole - 230 V $\sim$		
<b>AC type</b>				
		Sensitivity (mA)	In (A)	Number of modules
1	4 020 24	30	25	2
1	4 020 25	30	40	2
1	4 020 26	30	63	2
1	4 020 27	30	80	2
1	4 020 28	100	25	2
1	4 020 29	100	40	2
1	4 020 30	100	63	2
1	4 020 32	300	25	2
1	4 020 33	300	40	2
1	4 020 34	300	63	2
<b>A type</b>				
1	4 020 36	30	25	2
1	4 020 37	30	40	2
1	4 020 38	30	63	2

Pack	Cat.Nos	4-pole - 400 V $\sim$ neutral on right-hand side		
<b>AC type</b>				
		Sensitivity (mA)	In (A)	Number of modules
1	4 020 62	30	25	4
1	4 020 63	30	40	4
1	4 020 64	30	63	4
1	4 020 66	100	25	4
1	4 020 67	100	40	4
1	4 020 68	100	63	4
1	4 020 70	300	25	4
1	4 020 71	300	40	4
1	4 020 72	300	63	4
<b>A type</b>				
1	4 020 74	30	25	4
1	4 020 75	30	40	4
1	4 020 76	30	63	4

For detailed dimensions, **see e-catalogue**



## RCCBs RX<sup>3</sup>

technical characteristics

### ■ AC type - Standard applications

AC type RCCBs detect sinusoidal AC residual currents  
In the majority of cases (standard applications), they are used for AC current detection at 50 Hz

### ■ A type - Specific applications: dedicated lines

In addition to the characteristics of AC type RCCBs, A type RCCBs also detect pulsating DC residual currents  
They are used whenever fault currents are not sinusoidal  
They are particularly suitable for the following specific applications :  
hobs, washing machines or materials that may produce DC fault currents, speed drives with frequency inverters, etc.

**■ Cross reference list old range/new range**

		RX <sup>3</sup> 4500 Prong type supply busbar C curve		RX <sup>3</sup> 6000 Prong type supply busbar C curve	
		Old Cat.Nos	New Cat.Nos	Old Cat.Nos	New Cat.Nos
Single pole	3	4 021 51	-	4 023 09	-
	6	4 021 52	4 196 61	4 023 10	4 198 37
	10	4 021 53	4 196 62	4 023 11	4 198 38
	13	4 021 54	-	4 023 12	-
	16	4 021 55	4 196 64	4 023 13	4 198 40
	20	4 021 56	4 196 65	4 023 14	4 198 41
	25	4 021 57	4 196 66	4 023 15	4 198 42
	32	4 021 58	4 196 67	4 023 16	4 198 43
	40	4 021 59	4 196 68	4 023 17	4 198 44
	50	4 021 60	4 196 69	4 023 18	4 198 45
	63	4 021 61	4 196 70	4 023 19	4 198 46
2-pole	3	4 021 82	-	4 023 20	-
	6	4 021 83	4 196 94	4 023 21	4 198 70
	10	4 021 84	4 196 95	4 023 22	4 198 71
	13	4 021 85	-	4 023 23	-
	16	4 021 86	4 196 97	4 023 24	4 198 73
	20	4 021 87	4 196 98	4 023 25	4 198 74
	25	4 021 88	4 196 99	4 023 26	4 198 75
	32	4 021 89	4 197 00	4 023 27	4 198 76
	40	4 021 90	4 197 01	4 023 28	4 198 77
	50	4 021 91	4 197 02	4 023 29	4 198 78
	63	4 021 92	4 197 03	4 023 30	4 198 79
3-pole	3	4 021 93	-	4 023 31	-
	6	4 021 94	4 197 05	4 023 32	4 198 81
	10	4 021 95	4 197 06	4 023 33	4 198 82
	13	4 021 96	-	4 023 34	-
	16	4 021 97	4 197 08	4 023 35	4 198 84
	20	4 021 98	4 197 09	4 023 36	4 198 85
	25	4 021 99	4 197 10	4 023 37	4 198 86
	32	4 022 00	4 197 11	4 023 38	4 198 87
	40	4 022 01	4 197 12	4 023 39	4 198 88
	50	4 022 02	4 197 13	4 023 40	4 198 89
	63	4 022 03	4 197 14	4 023 41	4 198 90
4-pole	3	4 022 04	-	4 023 42	-
	6	4 022 05	4 197 38	4 023 43	4 199 14
	10	4 022 06	4 197 39	4 023 44	4 199 15
	13	4 022 07	-	4 023 45	-
	16	4 022 08	4 197 41	4 023 46	4 199 17
	20	4 022 09	4 197 42	4 023 47	4 199 18
	25	4 022 10	4 197 43	4 023 48	4 199 19
	32	4 022 11	4 197 44	4 023 49	4 199 20
	40	4 022 12	4 197 45	4 023 50	4 199 21
	50	4 022 13	4 197 46	4 023 51	4 199 22
	63	4 022 14	4 197 47	4 023 52	4 199 23

## MCBs TX<sup>3</sup> 6000

thermal magnetic MCBs from 6 A to 63 A - C curve



## RCCBs TX<sup>3</sup> - residual current circuit breakers

from 25 A to 63 A - AC and A types



Technical characteristics [see e-catalogue](#)

Conform to IEC 60898-1  
Compatible with prong-type supply busbars  
Breaking capacity:  
6000 - IEC 60898-1 - 230/400 V~  
6 kA - IEC 60947-2 - 230/400 V~  
Can be equipped with DX<sup>3</sup> signalling and remote tripping auxiliaries and motorised controls (p. 60-61)  
Do not accept add-on modules

Technical characteristics [see e-catalogue](#)

Conform to IEC 61008-1  
Compatible with prong-type supply busbars  
• AC type : detect AC component faults  
• A type : detect AC and DC component faults  
Do not accept auxiliaries

Pack	Cat.Nos	Single pole 230/400 V~	
	C curve	Nominal rating In (A)	Number of modules
10	4 035 74	6	1
10	4 035 75	10	1
10	4 035 76	16	1
10	4 035 77	20	1
10	4 035 78	25	1
10	4 035 79	32	1
10	4 035 80	40	1
10	4 035 81	50	1
10	4 035 82	63	1

Pack	Cat.Nos	Single pole + neutral 230 V~	
	C curve	Nominal rating In (A)	Number of modules
5	4 035 84	6	2
5	4 035 85	10	2
5	4 035 86	16	2
5	4 035 87	20	2
5	4 035 88	25	2
5	4 035 89	32	2
5	4 035 90	40	2

Pack	Cat.Nos	2-pole 230/400 V~	
	C curve	Nominal rating In (A)	Number of modules
5	4 036 04	6	2
5	4 036 05	10	2
5	4 036 06	16	2
5	4 036 07	20	2
5	4 036 08	25	2
5	4 036 09	32	2
5	4 036 10	40	2
5	4 036 11	50	2
5	4 036 12	63	2

Pack	Cat.Nos	3-pole 400 V~	
	C curve	Nominal rating In (A)	Number of modules
1	4 036 14	6	3
1	4 036 15	10	3
1	4 036 16	16	3
1	4 036 17	20	3
1	4 036 18	25	3
1	4 036 19	32	3
1	4 036 20	40	3
1	4 036 21	50	3
1	4 036 22	63	3

Pack	Cat.Nos	4-pole 400 V~	
	C curve	Nominal rating In (A)	Number of modules
1	4 036 24	6	4
1	4 036 25	10	4
1	4 036 26	16	4
1	4 036 27	20	4
1	4 036 28	25	4
1	4 036 29	32	4
1	4 036 30	40	4
1	4 036 31	50	4
1	4 036 32	63	4

Pack	Cat.Nos	2-pole - 230 V~	
	AC type	Sensitivity (mA)	In (A)
1	4 030 00	30	25
1	4 030 01	30	40
1	4 030 02	30	63
1	4 030 38	300	25
1	4 030 39	300	40
1	4 030 40	300	63
	A type	Sensitivity (mA)	In (A)
1	4 030 35	30	25
1	4 030 36	30	40

Pack	Cat.Nos	4-pole - 400 V~	
	AC type	Sensitivity (mA)	In (A)
1	4 030 04	30	25
1	4 030 05	30	40
1	4 030 06	30	63

Pack	Cat.Nos	4-pole - 400 V~	
	AC type	Sensitivity (mA)	In (A)
1	4 030 08	30	25
1	4 030 09	30	40
1	4 030 10	30	63
1	4 030 42	300	25
1	4 030 43	300	40
1	4 030 44	300	63

# MCBs TX<sup>3</sup> 6000

thermal magnetic MCBs from 2 A to 63 A - B & C curve

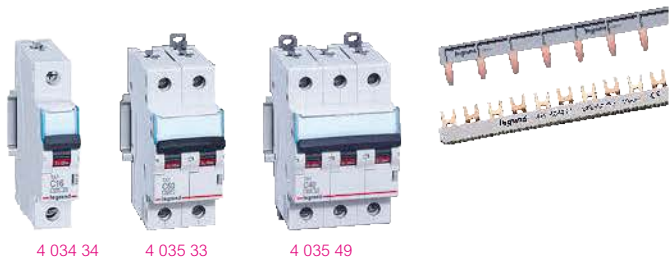

4 034 34    4 035 33    4 035 49

Technical characteristics [see e-catalogue](#)

Conform to IEC 60898-1  
 Compatible with prong-type and fork type supply busbars  
 Breaking capacity:  
 6000 - IEC 60898-1 - 230/400 V~  
 6 kA - IEC 60947-2 - 230/400 V~  
 Can be equipped with DX<sup>3</sup> signalling and remote tripping auxiliaries and motorised controls (p. 60-61)  
 Do not accept add-on modules

Pack	Cat.Nos		Single pole 230/400 V~	
	<b>AVAILABLE NOV 2014</b>			
	B curve	C curve	Nominal rating In (A)	Number of modules
10	4 033 50	4 034 27	2	1
10	4 033 53	4 034 30	6	1
10	4 033 55	4 034 32	10	1
10	4 033 56	4 034 33	13	1
10	4 033 57	4 034 34	16	1
10	4 033 58	4 034 35	20	1
10	4 033 59	4 034 36	25	1
10	4 033 60	4 034 37	32	1
10	4 033 61	4 034 38	40	1
10	4 033 62	4 034 39	50	1
10	4 033 63	4 034 40	63	1

Pack	Cat.Nos		2-pole 230/400 V~	
	<b>AVAILABLE NOV 2014</b>			
	B curve	C curve	Nominal rating In (A)	Number of modules
5	4 033 80	4 035 21	2	2
5	4 033 83	4 035 24	6	2
5	4 033 85	4 035 26	10	2
5	4 033 86	4 035 27	13	2
5	4 033 87	4 035 28	16	2
5	4 033 88	4 035 29	20	2
5	4 033 89	4 035 30	25	2
5	4 033 90	4 035 31	32	2
5	4 033 91	4 035 32	40	2
5	4 033 92	4 035 33	50	2
5	4 033 93	4 035 34	63	2

Pack	Cat.Nos		3-pole 400 V~	
	<b>AVAILABLE NOV 2014</b>			
	B curve	C curve	Nominal rating In (A)	Number of modules
1	4 033 95	4 035 38	2	3
1	4 033 98	4 035 41	6	3
1	4 034 00	4 035 43	10	3
1	4 034 01	4 035 44	13	3
1	4 034 02	4 035 45	16	3
1	4 034 03	4 035 46	20	3
1	4 034 04	4 035 47	25	3
1	4 034 05	4 035 48	32	3
1	4 034 06	4 035 49	40	3
1	4 034 07	4 035 50	50	3
1	4 034 08	4 035 51	63	3

Pack	Cat.Nos		4-pole 400 V~	
	<b>AVAILABLE NOV 2014</b>			
	B curve	C curve	Nominal rating In (A)	Number of modules
1	4 034 10	4 035 55	2	4
1	4 034 13	4 035 58	6	4
1	4 034 15	4 035 60	10	4
1	4 034 16	4 035 61	13	4
1	4 034 17	4 035 62	16	4
1	4 034 18	4 035 63	20	4
1	4 034 19	4 035 64	25	4
1	4 034 20	4 035 65	32	4
1	4 034 21	4 035 66	40	4
1	4 034 22	4 035 67	50	4
1	4 034 23	4 035 68	63	4

# MCBs TX<sup>3</sup> 10000

thermal magnetic MCBs from 2 A to 63 A - B & C curve

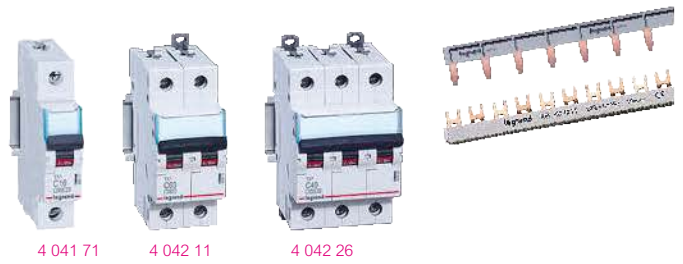

4 041 71    4 042 11    4 042 26

Technical characteristics [see e-catalogue](#)

Conform to IEC 60898-1  
 Compatible with prong-type and fork type supply busbars  
 Breaking capacity:  
 10000 - IEC 60898-1 - 230/400 V~  
 10 kA - IEC 60947-2 - 230/400 V~  
 Can be equipped with DX<sup>3</sup> signalling and remote tripping auxiliaries and motorised controls (p. 60-61)  
 Do not accept add-on modules

Pack	Cat.Nos		Single pole 230/400 V~	
	<b>AVAILABLE NOV 2014</b>			
	B curve	C curve	Nominal rating In (A)	Number of modules
10	4 040 78	4 041 64	2	1
10	4 040 81	4 041 67	6	1
10	4 040 82	4 041 69	10	1
10	4 040 83	4 041 70	13	1
10	4 040 84	4 041 71	16	1
10	4 040 85	4 041 72	20	1
10	4 040 86	4 041 73	25	1
10	4 040 87	4 041 74	32	1
10	4 040 88	4 041 75	40	1
10	4 040 89	4 041 76	50	1
10	4 040 90	4 041 77	63	1

Pack	Cat.Nos		2-pole 230/400 V~	
	<b>AVAILABLE NOV 2014</b>			
	B curve	C curve	Nominal rating In (A)	Number of modules
5	4 041 06	4 041 98	2	2
5	4 041 09	4 042 01	6	2
5	4 041 10	4 042 03	10	2
5	4 041 11	4 042 04	13	2
5	4 041 12	4 042 05	16	2
5	4 041 13	4 042 06	20	2
5	4 041 14	4 042 07	25	2
5	4 041 15	4 042 08	32	2
5	4 041 16	4 042 09	40	2
5	4 041 17	4 042 10	50	2
5	4 041 18	4 042 11	63	2

Pack	Cat.Nos		3-pole 400 V~	
	<b>AVAILABLE NOV 2014</b>			
	B curve	C curve	Nominal rating In (A)	Number of modules
1	4 041 20	4 042 15	2	3
1	4 041 23	4 042 18	6	3
1	4 041 24	4 042 20	10	3
1	4 041 25	4 042 21	13	3
1	4 041 26	4 042 22	16	3
1	4 041 27	4 042 23	20	3
1	4 041 28	4 042 24	25	3
1	4 041 29	4 042 25	32	3
1	4 041 30	4 042 26	40	3
1	4 041 31	4 042 27	50	3
1	4 041 32	4 042 28	63	3

Pack	Cat.Nos		4-pole 400 V~	
	<b>AVAILABLE NOV 2014</b>			
	B curve	C curve	Nominal rating In (A)	Number of modules
1	4 041 48	4 042 49	6	4
1	4 041 51	4 042 52	6	4
1	4 041 52	4 042 54	10	4
1	4 041 53	4 042 55	13	4
1	4 041 54	4 042 56	16	4
1	4 041 55	4 042 57	20	4
1	4 041 56	4 042 58	25	4
1	4 041 57	4 042 59	32	4
1	4 041 58	4 042 60	40	4
1	4 041 59	4 042 61	50	4
1	4 041 60	4 042 62	63	4

# RCCBs TX<sup>3</sup> residual current circuit breakers

from 16 A to 80 A - AC and A types



# MCBs DX-E 6000

thermal magnetic MCBs from 6 A to 63 A - B and C curves



Technical characteristics [see e-catalogue](#)

Conform to IEC 61008-1  
Compatible with prong-type and fork type supply busbars

- AC type : detect AC component faults
- A type : detect AC and DC component faults

Technical characteristics [see e-catalogue](#)

Conform to IEC 60898-1  
Compatible with prong-type and fork type supply busbars

- Breaking capacity **6000** - IEC 60898-1 - 400 V $\sim$   
6 kA - IEC 60947-2 - 400 V $\sim$
- Do not accept add-on modules
- For auxiliaries, please consult us

Pack	Cat.Nos	2-pole - 230 V $\sim$		
	<b>AVAILABLE NOV 2014</b>	<b>AC type</b>		
		Sensitivity (mA)	In (A)	Number of modules
1	4 115 02	10	16	2
1	4 115 09	30	25	2
1	4 115 10	30	40	2
1	4 115 11	30	63	2
1	4 115 12	30	80	2
1	4 115 19	100	25	2
1	4 115 20	100	40	2
1	4 115 21	100	63	2
1	4 115 22	100	80	2
1	4 115 29	300	25	2
1	4 115 30	300	40	2
1	4 115 31	300	63	2
1	4 115 32	300	80	2
		<b>A type</b>		
1	4 115 52	10	16	2
1	4 115 59	30	25	2
1	4 115 60	30	40	2
1	4 115 61	30	63	2
1	4 115 62	30	80	2
1	4 115 64	100	25	2
1	4 115 65	100	40	2
1	4 115 66	100	63	2
1	4 115 67	100	80	2
1	4 115 74	300	25	2
1	4 115 75	300	40	2
1	4 115 76	300	63	2
1	4 115 77	300	80	2

Pack	Cat.Nos	4-pole 400 V $\sim$		
	<b>AVAILABLE NOV 2014</b>	<b>AC type</b>		
		Sensitivity (mA)	In (A)	Number of modules
1	4 117 07	30	25	2
1	4 117 08	30	40	2
1	4 117 09	30	63	2
1	4 117 10	30	80	2
1	4 117 17	100	25	2
1	4 117 18	100	40	2
1	4 117 19	100	63	2
1	4 117 20	100	80	2
1	4 117 27	300	25	2
1	4 117 28	300	40	2
1	4 117 29	300	63	2
1	4 117 30	300	80	2
		<b>A type</b>		
1	4 117 64	30	25	2
1	4 117 65	30	40	2
1	4 117 66	30	63	2
1	4 117 67	30	80	2
1	4 117 74	100	25	2
1	4 117 75	100	40	2
1	4 117 76	100	63	2
1	4 117 77	100	80	2
1	4 117 84	300	25	2
1	4 117 85	300	40	2
1	4 117 86	300	63	2
1	4 117 87	300	80	2

Pack	Cat.Nos	Single pole 230/400 V $\sim$		
		B curve	C curve	Nominal rating In (A)
10	0 032 66	0 033 82		6
10	0 032 68	0 033 84		10
10	0 032 69	0 033 85		13
10	0 032 70	0 033 86		16
10	0 032 71	0 033 87		20
10	0 032 72	0 033 88		25
10	0 032 73	0 033 89		32
10	0 032 74	0 033 90		40
10	0 032 75	0 033 91		50
10	0 032 76	0 033 92		63

Pack	Cat.Nos	2-pole 230/400 V $\sim$		
		B curve	C curve	Nominal rating In (A)
5	0 033 08	0 034 29		6
5	0 033 10	0 034 31		10
5	0 033 11	0 034 32		13
5	0 033 12	0 034 33		16
5	0 033 13	0 034 34		20
5	0 033 14	0 034 35		25
5	0 033 15	0 034 36		32
5	0 033 16	0 034 37		40
5	0 033 17	0 034 38		50
5	0 033 18	0 034 39		63

Pack	Cat.Nos	3-pole 400 V $\sim$		
		B curve	C curve	Nominal rating In (A)
1	0 033 22	0 034 47		6
1	0 033 24	0 034 49		10
1	0 033 25	0 034 50		13
1	0 033 26	0 034 51		16
1	0 033 27	0 034 52		20
1	0 033 28	0 034 53		25
1	0 033 29	0 034 54		32
1	0 033 30	0 034 55		40
1	0 033 31	0 034 56		50
1	0 033 32	0 034 57		63

Pack	Cat.Nos	4-pole 400 V $\sim$		
		B curve	C curve	Nominal rating In (A)
1	0 033 68	0 034 89		6
1	0 033 70	0 034 91		10
1	0 033 71	0 034 92		13
1	0 033 72	0 034 93		16
1	0 033 73	0 034 94		20
1	0 033 74	0 034 95		25
1	0 033 75	0 034 96		32
1	0 033 76	0 034 97		40
1	0 033 77	0 034 98		50
1	0 033 78	0 034 99		63



# Isolating switches DX<sup>3</sup>-IS

from 16 A to 125 A



4 065 27

4 065 44

4 064 06

4 064 59

4 064 81

Dimensions **see e-catalogue**  
 Technical characteristics **p. 49**

AC 23 A according to IEC 60947 - 3, AC 22 A for 125 A  
 Double break contacts

Pack	Cat.Nos	Remote trip head isolating switches	
		Red handle Visible contact indication Remote tripping with associated control auxiliary (p. 60) Can be fitted with motorised controls (p. 61) Visual indication of the actual status of the contacts: - Closed position (red indicator) - Open position (green indicator)	
		<b>2P - 400 V~</b>	
		Nominal rating In (A)	Number of modules
1	4 065 27	40	2
1	4 065 28	63	2
		<b>3P - 400 V~</b>	
1	4 065 35	40	3
1	4 065 36	63	3
1	4 065 38 <sup>1</sup>	100	4,5
1	4 065 39 <sup>1</sup>	125	4,5
		<b>4P - 400 V~</b>	
1	4 065 43	40	4
1	4 065 44	63	4
1	4 065 46 <sup>1</sup>	100	6
1	4 065 47 <sup>1</sup>	125	6

1: Can be equipped with add-on modules

Pack	Cat.Nos	Isolating switches	
		Grey handle Can be equipped with 1 DX <sup>3</sup> signalling auxiliary (p. 60)	
		<b>1P - 250 V~</b>	
		Nominal rating In (A)	Number of modules
10	4 064 00	16	1
10	4 064 01	20	1
10	4 064 03	32	1
10	4 064 11	40	1
10	4 064 12	63	1
10	4 064 23	100	1
		<b>1P with indicator - 250 V~</b>	
		Supplied with lamp	
10	4 064 04	20	1
10	4 064 06	32	1
		<b>2P - 400 V~</b>	
10	4 064 31	16	1
10	4 064 32	20	1
10	4 064 34	32	1
5	4 064 40	40	2
5	4 064 41	63	2
5	4 064 49	100	2
5	4 064 50	125	2
		<b>2P with indicator - 400 V~</b>	
		Supplied with lamp Do not accept auxiliaries	
10	4 064 36	20	1
10	4 064 38	32	1
10	4 064 39	40	1
		<b>3P - 400 V~</b>	
5	4 064 57	20	2
5	4 064 59	32	2
1	4 064 60	40	3
1	4 064 61	63	3
1	4 064 69	100	3
1	4 064 70	125	3
		<b>4P - 400 V~</b>	
5	4 064 77	20	2
5	4 064 79	32	2
1	4 064 80	40	4
1	4 064 81	63	4
1	4 064 89	100	4
1	4 064 90	125	4

## RCCBs - DX<sup>3</sup>-ID

residual current circuit breakers 16 A to 100 A - AC, A, Hpi and B types



Technical characteristics **see e-catalogue**

Conform to IEC 61008 - 1

- AC type : detect sinusoidal AC residual currents
- A type : detect sinusoidal AC and pulsating DC residual currents
- Hpi type (High immunity) : detect AC and pulsating DC residual currents  
Enhanced immunity to unwanted tripping in disturbed environments
- B type : detect sinusoidal AC, pulsating DC and smooth DC residual currents

Can be equipped with DX<sup>3</sup> signalling and remote tripping auxiliaries, except for B type (p. 60) and motorised controls (p. 61)

Pack	Cat.Nos	2-pole 230 V $\sim$			Pack	Cat.Nos	4-pole - 400 V $\sim$ - neutral on right-hand side		
		<b>AC type</b>					<b>AC type</b>		
		Sensitivity (mA)	Nominal Rating In (A)	Number of modules		Vis/vis	Sensitivity (mA)	In (A)	Number of modules
1	4 115 00	10	16	2	1	4 117 02	30	25	4
1	4 115 04	30	25	2	1	4 117 03	30	40	4
1	4 115 05	30	40	2	1	4 117 04	30	63	4
1	4 115 06	30	63	2	1	4 117 05	30	80	4
1	4 115 07	30	80	2	1	4 117 12	100	25	4
1	4 115 08	30	100	2	1	4 117 13	100	40	4
1	4 115 14	100	25	2	1	4 117 14	100	63	4
1	4 115 15	100	40	2	1	4 117 15	100	80	4
1	4 115 16	100	63	2	1	4 117 22	300	25	4
1	4 115 17	100	80	2	1	4 117 23	300	40	4
1	4 115 24	300	25	2	1	4 117 24	300	63	4
1	4 115 25	300	40	2	1	4 117 25	300	80	4
1	4 115 26	300	63	2	1	4 117 45	300 selective	40	4
1	4 115 27	300	80	2	1	4 117 46	300 selective	63	4
1	4 115 28	300	100	2	1	4 117 32	500	25	4
1	4 115 37	100 selective	100	2	1	4 117 33	500	40	4
1	4 115 43	300 selective	63	2	1	4 117 34	500	63	4
					1	4 117 35	500	80	4
		<b>A type</b>					<b>A type</b>		
1	4 115 50	10	16	2	1	4 117 59	30	25	4
1	4 115 54	30	25	2	1	4 117 60	30	40	4
1	4 115 55	30	40	2	1	4 117 61	30	63	4
1	4 115 56	30	63	2	1	4 117 62	30	80	4
1	4 115 57	30	80	2	1	4 117 63	30	100	4
1	4 115 69	300	25	2	1	4 117 69	100	25	4
1	4 115 70	300	40	2	1	4 117 70	100	40	4
1	4 115 71	300	63	2	1	4 117 71	100	63	4
1	4 115 72	300	80	2	1	4 117 72	100	80	4
		<b>Hpi type</b>					<b>Hpi type</b>		
1	4 115 90	30	25	2	1	4 117 73	100	100	4
1	4 115 91	30	40	2	1	4 117 79	300	25	4
1	4 115 92	30	63	2	1	4 117 80	300	40	4
		<b>B type</b>					<b>B type</b>		
		Do not accept auxiliaries					Do not accept auxiliaries		
1	4 118 42	30	40	4	1	4 117 81	300	63	4
1	4 118 43	30	63	4	1	4 117 82	300	80	4
1	4 118 44	300	40	4	1	4 117 83	300	100	4
1	4 118 45	300	63	4	1	4 118 00	300 selective	40	4
							<b>4-pole - 400 V<math>\sim</math> - neutral on left-hand side</b>		
							<b>B type</b>		
							Do not accept auxiliaries		
1	4 118 46	30	40	4	1	4 118 01	300 selective	63	4
1	4 118 47	30	63	4	1	4 117 89	500	25	4
1	4 118 48	300	40	4	1	4 117 90	500	40	4
1	4 118 49	300	63	4	1	4 117 91	500	63	4
							<b>4-pole - 400 V<math>\sim</math> - neutral on right-hand side</b>		
							<b>B type</b>		
							Do not accept auxiliaries		
1	4 118 46	30	40	4	1	4 117 92	500	80	4
1	4 118 47	30	63	4	1	4 117 93	500	100	4
1	4 118 48	300	40	4					
1	4 118 49	300	63	4					

Auxiliaries, accessories and remote control **p. 60-61**



## Isolating switches DX<sup>3</sup>-IS

### technical characteristics

#### DX<sup>3</sup>-IS remote trip head isolating switches

##### Electrical characteristics

Thermal rating (Ith)	40 - 63 A 1 module/pole	100 - 125 A 1.5 module/pole
Terminals	Cage	Cage
Connection	flexible	1.5 to 25 mm <sup>2</sup>
	rigid	1.5 to 35 mm <sup>2</sup>
Insulation voltage (Hi)	500 V ~	500 V ~
Impulse withstand voltage (Uimp)	6 kV	6 kV
Category of use <sup>(1)</sup>	AC 22A / AC 23A	100 A = AC 22A / AC 23A 125 A = AC 22A
Short time withstand current (Icw)	1000 A during 1 s 1700 A during 0.5 s	1000 A during 1 s 1500 A during 0.5 s
Short-circuit making capacity (Icm)	3000 A	1500 A
No. of electrical operations	15000	10000
Protection index	IP 2X wired	IP 2X wired

(1) test conditions according to IEC 60947-3  
 AC 22 A: combined motor/resistor breaking with frequent operations  
 AC 23 A: inductive motor breaking at In/2 with frequent operations

#### DX<sup>3</sup>-IS isolating switches

##### Electrical characteristics

Thermal rating (Ith)	16 - 40 A 0.5 module/pole	40 - 63 A 1 module/pole	100 - 125 A 1 module/pole
Terminals	Cage	Cage	Cage
Connection	flexible	1.5 to 10 mm <sup>2</sup>	4 to 35 mm <sup>2</sup>
	rigid	1.5 to 16 mm <sup>2</sup>	4 to 50 mm <sup>2</sup>
Insulation voltage (Hi)	500 V ~	500 V ~	500 V ~
Impulse withstand voltage (Uimp)	6 kV	6 kV	6 kV
Category of use <sup>(1)</sup>	AC 22 A	AC 22 A	AC 22 A
Short time withstand current (Icw)	750 A	2000 A	2500 A
Short-circuit making capacity (Icm)	1500 A	3000 A	3700 A
No. of electrical operations	30000	20000	5000
Protection index	IP 2X wired	IP 2X wired	IP 2X wired

(1) test conditions according to IEC 60947-3  
 AC 22 A: combined motor/resistor breaking with frequent operations

## RCCBs DX<sup>3</sup>-ID

### technical characteristics

#### DX<sup>3</sup>-ID - RCCBs (residual current circuit breakers)

##### Connection cross-section

RCCBs	Cable (mm <sup>2</sup> )	
	Rigid	Flexible
Connection at top and bottom	50	35

#### AC type - Standard applications

AC type RCCBs detect sinusoidal AC residual currents. In the majority of cases (standard applications), they are used for AC current detection at 50 Hz.

#### A type - Specific applications: dedicated lines

In addition to the characteristics of AC type RCCBs, A type RCCBs also detect pulsating DC residual currents. They are used whenever fault currents are not sinusoidal. They are particularly suitable for the following specific applications: hobs, washing machines or materials that may produce DC fault currents, speed drives with frequency inverters, etc.

#### B type - Specific applications: dedicated lines

In addition to the characteristics of A type RCCBs, B type RCCBs also detect smooth DC residual currents. They are used whenever fault currents are not sinusoidal. They are particularly suitable for the following specific applications: speed drives and inverters for supplying motors for pumps, lifts, textile machines, machine tools, photovoltaic installations, call centres, medical equipment, etc.

#### Hpi type - Special applications

Type Hpi RCCBs are devices which offer additional immunity to unwanted tripping which significantly exceeds the level required by the standard. They are also able to detect AC and DC residual currents (A type). Operation between - 25 °C and + 40 °C. They are used in special applications where:

- Loss of information is potentially damaging, e.g. power supply lines for computer equipment (banks, equipment on military bases, flight reservation centres, etc.)
- Loss of operation is potentially damaging (automated machinery, medical equipment, freezer cable, etc.)

They are also used:

- On sites where there is an increased risk of lightning strikes (see p. 63)
- On sites where cables are subject to high levels of interference (use of fluorescents, etc.)
- On sites where very long cables are used

## RCBOs DX™ 10000

residual current circuit breakers from 10 A to 45 A - AC type



6 064 15

Technical characteristics [see e-catalogue](#)

Breaking capacity:

10000 - IEC 61009-1

- AC type : detect AC component faults

Pack	Cat.Nos	Single pole - 230 V~
		Blue neutral leads
		<b>AC Type  30 mA</b>
		Nominal rating In (A)
		Number of modules
1	6 064 10	10
1	6 064 11	16
1	6 064 12	20
1	6 064 13	25
1	6 064 14	32
1	6 064 15	45

## RCBOs DX<sup>3</sup> 6000 - 10 kA - residual current circuit

breakers from 3 A to 63 A - AC, A and Hpi types



4 110 02

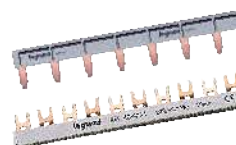

Technical characteristics [see e-catalogue](#)

Conform to IEC 61009-1

Compatible with prong-type and fork type supply busbars

Breaking capacity:

6000 - IEC 61009-1 - 10 kA / IEC 60947-2 for single pole + neutral, 2 and 4-pole

- AC type : detect AC component faults
- A type : detect AC and DC component faults
- Hpi type (High immunity) : detect AC and DC component faults

Enhanced immunity to unwanted tripping in disturbed environments

Can be equipped with DX<sup>3</sup> signalling and remote tripping auxiliaries and motorised controls (p. 60-61)

Pack	Cat.Nos	Single pole + neutral - 230 V~
		Neutral on right-hand side
		<b>AC Type  10 mA</b>
		Nominal rating In (A)
		Number of modules
1	4 109 93	16
		<b>AC Type  30 mA</b>
		Nominal rating In (A)
		Number of modules
1	4 109 97	3
1	4 109 99	6
1	4 110 00	10
1	4 110 02	16
1	4 110 03	20
1	4 110 04	25
1	4 110 05	32
1	4 110 06	40
		<b>AC Type  300 mA</b>
		Nominal rating In (A)
		Number of modules
1	4 110 21	6
1	4 110 22	10
1	4 110 24	16
1	4 110 25	20
1	4 110 26	25
1	4 110 27	32
1	4 110 28	40
		<b>A Type  10 mA</b>
		Nominal rating In (A)
		Number of modules
1	4 110 41	16
		<b>A Type  30 mA</b>
		Nominal rating In (A)
		Number of modules
1	4 110 47	6
1	4 110 48	10
1	4 110 50	16
1	4 110 51	20
1	4 110 52	25
1	4 110 53	32
1	4 110 54	40
		<b>Hpi Type   30 mA</b>
		Nominal rating In (A)
		Number of modules
1	4 110 91	6
1	4 110 92	10
1	4 110 94	16
1	4 110 95	20
1	4 110 96	25
1	4 110 97	32
1	4 110 98	40

# RCBOs DX<sup>3</sup> 6000 - 10 kA

residual current circuit breakers from 10 A to 63 A - AC, A and Hpi types (continued)



4 111 49



4 111 92



4 112 41

Technical characteristics **see e-catalogue**

Conform to IEC 61009-1

Breaking capacity:

[6000 - IEC 61009-1 - 10 kA / IEC 60947-2 for single pole + neutral, 2 and 4-pole

- AC type : detect AC component faults
- A type : detect AC and DC component faults
- Hpi type (High immunity) : detect AC and DC component faults

Enhanced immunity to unwanted tripping in disturbed environments

Can be equipped with DX<sup>3</sup> signalling and remote tripping auxiliaries and motorised controls (p. 60-61)

Pack	Cat.Nos	2-pole - 230 V~	
Compatible with prong-type supply busbars			
<b>AC Type  10 mA</b>			
	C curve	Nominal rating I <sub>n</sub> (A)	Number of modules
1	4 111 49	10	4
1	4 111 50	16	4
1	4 111 51	20	4
<b>AC Type  30 mA</b>			
1	4 111 57	10	4
1	4 111 58	16	4
1	4 111 59	20	4
1	4 111 60	25	4
1	4 111 61	32	4
1	4 111 62	40	4
1	4 111 63	50	4
1	4 111 64	63	4
<b>AC Type  300 mA</b>			
1	4 111 71	10	4
1	4 111 72	16	4
1	4 111 73	20	4
1	4 111 74	25	4
1	4 111 75	32	4
1	4 111 76	40	4
1	4 111 77	50	4
1	4 111 78	63	4

Pack	Cat.Nos	4-pole - 400 V~	
4-module RCBOs are compatible with prong-type and fork type supply busbars			
7-module RCBOs are compatible with prong-type supply busbars only			
<b>AC Type  30 mA</b>			
	C curve	Nominal rating I <sub>n</sub> (A)	Number of modules
1	4 111 85	10	4
1	4 111 86	16	4
1	4 111 87	20	4
1	4 111 88	25	4
1	4 111 89	32	4
1	4 111 90	40	7
1	4 111 91	50	7
1	4 111 92	63	7
<b>AC Type  300 mA</b>			
1	4 112 04	10	4
1	4 112 05	16	4
1	4 112 06	20	4
1	4 112 07	25	4
1	4 112 08	32	4
1	4 112 09	40	7
1	4 112 10	50	7
1	4 112 11	63	7
<b>A Type  30 mA</b>			
1	4 112 33	10	4
1	4 112 34	16	4
1	4 112 35	20	4
1	4 112 36	25	4
1	4 112 37	32	4
<b>A Type  300 mA</b>			
1	4 112 38	10	4
1	4 112 39	16	4
1	4 112 40	20	4
1	4 112 41	25	4
1	4 112 42	32	4
<b>Hpi Type   30 mA</b>			
1	4 112 44	16	4
1	4 112 45	20	4
1	4 112 46	25	4
1	4 112 47	32	4

For detailed dimensions, **see e-catalogue**



# MCBs DX<sup>3</sup> [6000] - 10 kA

thermal magnetic circuit breakers from 1 A to 63 A - B and C curves



4 074 35



4 078 02



4 075 65



4 079 34

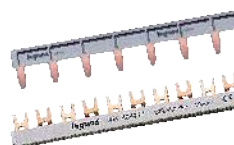

Technical characteristics [see e-catalogue](#)

Conform to IEC 60898-1

Compatible with both, prong-type and fork type supply busbars

Breaking capacity

[6000] - IEC 60898-1 - 400 V~

10 kA - IEC 60947-2 - 400 V~

Can be equipped with DX<sup>3</sup> signalling and remote tripping auxiliaries, motorised controls (p. 60-61) and add-on modules (p. 58)

Pack	Cat.Nos		Single pole 230/400 V~	
	B curve	C curve	Nominal rating In (A)	Number of modules
1	4 074 25	4 076 62	1	1
1	4 074 26	4 076 63	2	1
1	4 074 27	4 076 64	3	1
1	4 074 29	4 076 66	6	1
10	4 074 30	4 076 68	10	1
10	4 074 32	4 076 70	16	1
1	4 074 33	4 076 71	20	1
1	4 074 34	4 076 72	25	1
1	4 074 35	4 076 73	32	1
1	4 074 36	4 076 74	40	1
1	4 074 37	4 076 75	50	1
1	4 074 38	4 076 76	63	1

Pack	Cat.Nos		3-pole 400 V~	
	B curve	C curve	Nominal rating In (A)	Number of modules
1	4 075 54	4 078 51	1	3
1	4 075 55	4 078 52	2	3
1	4 075 56	4 078 53	3	3
1	4 075 58	4 078 55	6	3
1	4 075 59	4 078 57	10	3
1	4 075 61	4 078 59	16	3
1	4 075 62	4 078 60	20	3
1	4 075 63	4 078 61	25	3
1	4 075 64	4 078 62	32	3
1	4 075 65	4 078 63	40	3
1	4 075 66	4 078 64	50	3
1	4 075 67	4 078 65	63	3

		Single pole + neutral 230 V~		
		Neutral on right-hand side		
	B curve	C curve	Nominal rating In (A)	Number of modules
1	4 074 68	4 077 34	1	1
1	4 074 69	4 077 35	2	1
1	4 074 70	4 077 36	3	1
1	4 074 72	4 077 38	6	1
1	4 074 73	4 077 40	10	1
10	4 074 75	4 077 42	16	1
1	4 074 76	4 077 43	20	1
1	4 074 77	4 077 44	25	1
1	4 074 78	4 077 45	32	1
1	4 074 79	4 077 46	40	1

		4-pole 400 V~		
	B curve	C curve	Nominal rating In (A)	Number of modules
1	4 076 17	4 079 20	1	4
1	4 076 18	4 079 21	2	4
1	4 076 19	4 079 22	3	4
1	4 076 21	4 079 24	6	4
1	4 076 22	4 079 26	10	4
1	4 076 24	4 079 28	16	4
1	4 076 25	4 079 29	20	4
1	4 076 26	4 079 30	25	4
1	4 076 27	4 079 31	32	4
1	4 076 28	4 079 32	40	4
1	4 076 29	4 079 33	50	4
1	4 076 30	4 079 34	63	4

		2-pole 230/400 V~		
	B curve	C curve	Nominal rating In (A)	Number of modules
1	4 075 02	4 077 92	1	2
1	4 075 03	4 077 93	2	2
1	4 075 04	4 077 94	3	2
1	4 075 06	4 077 96	6	2
1   5	4 075 07	4 077 98	10	2
1   5	4 075 09	4 078 00	16	2
1	4 075 10	4 078 01	20	2
1	4 075 11	4 078 02	25	2
1	4 075 12	4 078 03	32	2
1	4 075 13	4 078 04	40	2
1	4 075 14	4 078 05	50	2
1	4 075 15	4 078 06	63	2

## MCBs DX<sup>3</sup> [6000] - 10 kA

thermal magnetic circuit breakers from 1 A to 63 A - D curve



4 079 67



4 080 33

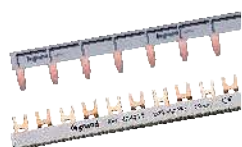

Technical characteristics **see e-catalogue**

Conform to IEC 60898-1

Compatible with both, prong-type and fork type supply busbars

Breaking capacity

[6000] - IEC 60898-1 - 400 V~

10 kA - IEC 60947-2 - 400 V~

Can be equipped with DX<sup>3</sup> signalling and remote tripping auxiliaries, motorised controls (p. 60-61) and add-on modules (p. 58)

Pack	Cat.Nos	Single pole 230/400 V~	Nominal rating I <sub>n</sub> (A)	Number of modules
	D curve			
1	4 079 63	1	1	1
1	4 079 64	2	1	1
1	4 079 65	3	1	1
1	4 079 67	6	1	1
1	4 079 69	10	1	1
1	4 079 71	16	1	1
1	4 079 72	20	1	1
1	4 079 73	25	1	1
1	4 079 74	32	1	1
1	4 079 75	40	1	1
1	4 079 76	50	1	1
1	4 079 77	63	1	1

Pack	Cat.Nos	2-pole 230/400 V~	Nominal rating I <sub>n</sub> (A)	Number of modules
	D curve			
1	4 080 23	1	2	2
1	4 080 24	2	2	2
1	4 080 25	3	2	2
1	4 080 27	6	2	2
1	4 080 29	10	2	2
1	4 080 31	16	2	2
1	4 080 32	20	2	2
1	4 080 33	25	2	2
1	4 080 34	32	2	2
1	4 080 35	40	2	2
1	4 080 36	50	2	2
1	4 080 37	63	2	2

Pack	Cat.Nos	3-pole 400 V~	Nominal rating I <sub>n</sub> (A)	Number of modules
	D curve			
1	4 080 81	1	3	3
1	4 080 82	2	3	3
1	4 080 83	3	3	3
1	4 080 85	6	3	3
1	4 080 87	10	3	3
1	4 080 89	16	3	3
1	4 080 90	20	3	3
1	4 080 91	25	3	3
1	4 080 92	32	3	3
1	4 080 93	40	3	3
1	4 080 94	50	3	3
1	4 080 95	63	3	3

Pack	Cat.Nos	4-pole 400 V~	Nominal rating I <sub>n</sub> (A)	Number of modules
	D curve			
1	4 081 43	6	4	4
1	4 081 45	10	4	4
1	4 081 47	16	4	4
1	4 081 48	20	4	4
1	4 081 49	25	4	4
1	4 081 50	32	4	4
1	4 081 51	40	4	4
1	4 081 52	50	4	4
1	4 081 53	63	4	4

## AUXILIARIES AND REMOTE CONTROL

# Common auxiliaries & remote control

The signalling and remote tripping auxiliaries and the motorised controls are common for DX<sup>3</sup> MCBs, RCBOs and RCCBs and TX<sup>3</sup> MCBs. Signalling auxiliaries are available in two versions, adapted to the pin or fork type supply busbars.



1 module motorised controls p. 61

### COMPACT SIZE

1 module motorised controls for remote tripping of 1-pole to 4-pole modular devices.



Auxiliaries p. 61

### EASY TO INSTALL

Perfect fitting to protection devices  
Easy access and visible terminals  
Allow insertion of supply busbars



Power overvoltage protection p. 60  
Motorised control with automatic resetting p. 61

### AVAILABLE FUNCTIONS

- auxiliary or fault signal contact
- current shunt trips
- undervoltage releases
- power overvoltage protection
- motorised controls with or without automatic resetting

# MCBs DX<sup>3</sup> 10000 - 16 kA

thermal magnetic circuit breakers from 1 A to 125 A - B, C and D curves

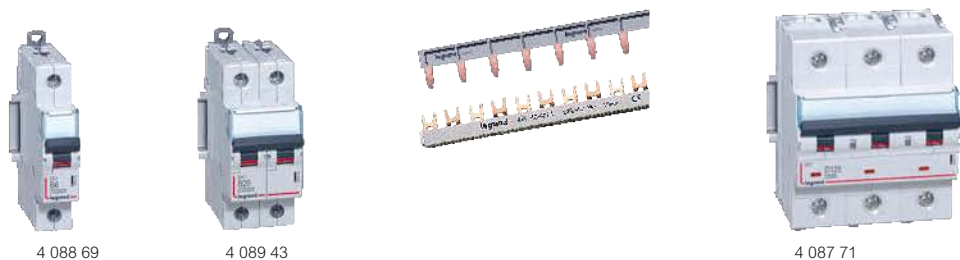

Technical characteristics **see e-catalogue**

Conform to IEC 60898-1  
 Compatible with prong-type and fork type supply busbars  
 (except 80 A, 100 A and 125 A MCBs)  
 Breaking capacity  
**10000** - IEC 60898-1 - 400 V $\sim$   
 16 kA - IEC 60947-2 - 400 V $\sim$   
 Can be equipped with DX<sup>3</sup> signalling and remote tripping auxiliaries,  
 motorised controls (p. 60-61) and add-on modules (p. 58-59)

Pack	Cat.Nos		Single pole 230/400 V $\sim$	
	B curve	C curve	Nominal rating In (A)	Number of modules
1	4 088 65	4 091 07	1	1
1	4 088 66	4 091 08	2	1
1	4 088 67	4 091 09	3	1
1	4 088 69	4 091 11	6	1
1   10	4 088 70	4 091 12	10	1
1	4 088 71	4 091 13	13	1
1   10	4 088 72	4 091 14	16	1
1	4 088 73	4 091 15	20	1
1	4 088 74	4 091 16	25	1
1	4 088 75	4 091 17	32	1
1	4 088 76	4 091 18	40	1
1	4 088 77	4 091 19	50	1
1	4 088 78	4 091 20	63	1
1		4 085 99	80	1.5
1		4 086 00	100	1.5
1		4 086 01	125	1.5

	Cat.Nos		2-pole 230/400 V $\sim$	
	B curve	C curve	Nominal rating In (A)	Number of modules
1	4 089 35	4 091 95	1	2
1	4 089 36	4 091 96	2	2
1	4 089 37	4 091 97	3	2
1	4 089 39	4 091 99	6	2
1	4 089 40	4 092 00	10	2
1	4 089 41	4 092 01	13	2
1	4 089 42	4 092 02	16	2
1	4 089 43	4 092 03	20	2
1	4 089 44	4 092 04	25	2
1	4 089 45	4 092 05	32	2
1	4 089 46	4 092 06	40	2
1	4 089 47	4 092 07	50	2
1	4 089 48	4 092 08	63	2
1		4 086 40	80	3
1		4 086 41	100	3
1		4 086 42	125	3

	Cat.Nos		3-pole 400 V $\sim$	
	B curve	C curve	Nominal rating In (A)	Number of modules
1	4 089 84	4 092 47	1	3
1	4 089 85	4 092 48	2	3
1	4 089 86	4 092 49	3	3
1	4 089 88	4 092 51	6	3
1	4 089 89	4 092 52	10	3
1	4 089 90	4 092 53	13	3
1	4 089 91	4 092 54	16	3
1	4 089 92	4 092 55	20	3
1	4 089 93	4 092 56	25	3
1	4 089 94	4 092 57	32	3
1	4 089 95	4 092 58	40	3
1	4 089 96	4 092 59	50	3
1	4 089 97	4 092 60	63	3
1		4 086 62	80	4.5
1		4 086 63	100	4.5
1		4 086 64	125	4.5

Pack	Cat.Nos		4-pole 400 V $\sim$	
	B curve	C curve	Nominal rating In (A)	Number of modules
1	4 090 58	4 093 29	1	4
1	4 090 59	4 093 30	2	4
1	4 090 60	4 093 31	3	4
1	4 090 62	4 093 33	6	4
1	4 090 63	4 093 34	10	4
1	4 090 64	4 093 35	13	4
1	4 090 65	4 093 36	16	4
1	4 090 66	4 093 37	20	4
1	4 090 67	4 093 38	25	4
1	4 090 68	4 093 39	32	4
1	4 090 69	4 093 40	40	4
1	4 090 70	4 093 41	50	4
1	4 090 71	4 093 42	63	4
1		4 087 03	80	6
1		4 087 04	100	6
1		4 087 05	125	6

	Cat.Nos		3-pole 400 V $\sim$ - D curve	
	D curve	Nominal rating In (A)	Number of modules	
1	4 087 69	80	4.5	
1	4 087 70	100	4.5	
1	4 087 71	125	4.5	

Supply busbars and modular distribution blocks **p. 178**

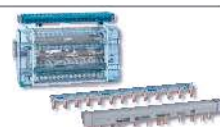



## MCBs DX<sup>3</sup> - 16 kA - direct current

thermal magnetic circuit breakers from 0.5 A to 63 A



4 095 69

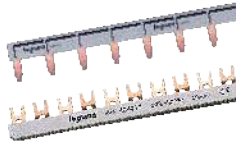

Technical characteristics **see e-catalogue**

Operating voltage from 12 V<sub>DC</sub> to 500 V<sub>DC</sub>  
 Breaking capacity  
 16 kA - IEC 60947-2 - 230 V<sub>DC</sub>  
 10 kA - IEC 60947-2 - 440 V<sub>DC</sub>  
 6 kA - IEC 60947-2 - 500 V<sub>DC</sub>  
 Magnetic threshold from 5 to 7 I<sub>n</sub>  
 Can be equipped with DX<sup>3</sup> signalling and remote tripping auxiliaries and motorised controls (p. 60-61)

Pack	Cat.Nos	Direct current circuit breakers		
		Nominal rating I <sub>n</sub> (A)	Number of poles protected	Number of modules
1	4 095 59	0,5	2	2
1	4 095 60	1	2	2
1	4 095 61	1,6	2	2
1	4 095 62	2	2	2
1	4 095 63	3	2	2
1	4 095 64	4	2	2
1	4 095 65	6	2	2
1	4 095 66	8	2	2
1	4 095 67	10	2	2
1	4 095 68	16	2	2
1	4 095 69	20	2	2
1	4 095 70	25	2	2
1	4 095 71	32	2	2
1	4 095 72	40	2	2
1	4 095 73	50	2	2
1	4 095 74	63	2	2

## MANUAL SUPPLY INVERTORS, FRONT EXTERNAL HANDLES

# Discover the new products

Thanks to the new manual supply invertors you can improve the continuity of service of your installation.

The front external rotary handles allow a better control of the modular devices without opening the door of the enclosure.



Manual supply inverter p. 61

### MANUAL SUPPLY INVERTOR (MSI)

For 2P, 3P and 4P DX<sup>3</sup> and MCBs and remote trip isolating switches  
 For manually switching between mains and an alternative power supply



Front external rotary handle p. 61

### EXTERNAL HANDLE

For all DX<sup>3</sup>, TX<sup>3</sup> and RX<sup>3</sup> devices from 2P upwards.  
 Allow the manual control of the modular devices without opening the enclosure  
 Available in two versions : with black or yellow & red handle

For detailed dimensions, **see e-catalogue**



**Other new products:**  
 DX<sup>3</sup> add-on modules with integrated measuring unit **p. 59**



Installation principle **see e-catalogue**



# MCBs DX<sup>3</sup> - 25 kA

thermal magnetic MCBs from 2 A to 125 A - C and D curves



4 097 72



4 098 24



4 098 03

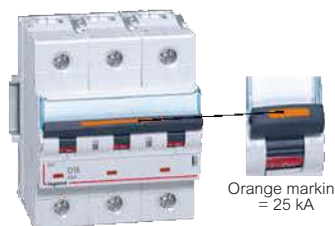

4 098 33

Technical characteristics [see e-catalogue](#)

Breaking capacity:  
25 kA - IEC 60947-2 - 400 V<sub>~</sub>  
Can be equipped with DX<sup>3</sup> signalling and remote tripping auxiliaries and motorised controls (p. 60-61)

Pack	Cat.Nos		Single pole 230/400 V <sub>~</sub>	
	C curve	D curve	Nominal rating I <sub>n</sub> (A)	Number of modules
1	4 097 52	4 098 04	2	1
1	4 097 53	4 098 05	6	1
1	4 097 54	4 098 06	10	1
1	4 097 55	4 098 07	16	1/1.5
1	4 097 56	4 098 08	20	1/1.5
1	4 097 57	4 098 09	25	1/1.5
1	4 097 58	4 098 10	32	1.5
1	4 097 59	4 098 11	40	1.5
1	4 097 60	4 098 12	50	1.5
1	4 097 61	4 098 13	63	1.5
1	4 097 62	4 098 14	80	1.5
1	4 097 63	4 098 15	100	1.5
1	4 097 64	4 098 16	125	1.5

Pack	Cat.Nos		2-pole - 230/400 V <sub>~</sub>	
	C curve	D curve	Nominal rating I <sub>n</sub> (A)	Number of modules
1	4 097 65	4 098 17	2	2
1	4 097 66	4 098 18	6	2
1	4 097 67	4 098 19	10	2
1	4 097 68	4 098 20	16	2
1	4 097 69	4 098 21	20	2
1	4 097 70	4 098 22	25	2
1	4 097 71	4 098 23	32	2/3
1	4 097 72	4 098 24	40	3
1	4 097 73		50	3
1	4 097 74		63	3
1	4 097 75		80	3
1	4 097 76		100	3
1	4 097 77		125	3

Pack	Cat.Nos		3-pole - 400 V <sub>~</sub>	
	C curve	D curve	Nominal rating I <sub>n</sub> (A)	Number of modules
1	4 097 78	4 098 30	2	3
1	4 097 79	4 098 31	6	3
1	4 097 80	4 098 32	10	3
1	4 097 81	4 098 33	16	3/4.5
1	4 097 82	4 098 34	20	3/4.5
1	4 097 83	4 098 35	25	3/4.5
1	4 097 84	4 098 36	32	4.5
1	4 097 85	4 098 37	40	4.5
1	4 097 86	4 098 38	50	4.5
1	4 097 87	4 098 39	63	4.5
1	4 097 88	4 098 40	80	4.5
1	4 097 89	4 098 41	100	4.5
1	4 097 90	4 098 42	125	4.5

Pack	Cat.Nos		4-pole - 400 V <sub>~</sub>	
	C curve	D curve	Nominal rating I <sub>n</sub> (A)	Number of modules
1	4 097 91	4 098 43	2	4
1	4 097 92	4 098 44	6	4
1	4 097 93	4 098 45	10	4
1	4 097 94	4 098 46	16	4/6
1	4 097 95	4 098 47	20	4/6
1	4 097 96	4 098 48	25	4/6
1	4 097 97	4 098 49	32	6
1	4 097 98	4 098 50	40	6
1	4 097 99	4 098 51	50	6
1	4 098 00	4 098 52	63	6
1	4 098 01	4 098 53	80	6
1	4 098 02	4 098 54	100	6
1	4 098 03	4 098 55	125	6

# MCBs DX<sup>3</sup> - 50 kA

thermal magnetic MCBs from 10 A to 63 A - C and D curves



4 101 51



4 102 00



4 101 80

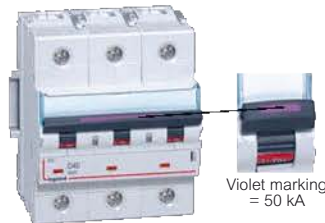

4 102 17

Technical characteristics **see e-catalogue**

Breaking capacity:  
50 kA - IEC 60947-2 - 400 V<sub>~</sub>  
Can be equipped with DX<sup>3</sup> signalling and remote tripping auxiliaries and motorised controls (p. 60-61)

Pack	Cat.Nos		Single pole 230/400 V <sub>~</sub>	
	C curve	D curve	Nominal rating I <sub>n</sub> (A)	Number of modules
1	4 101 34	4 101 86	10	1.5
1	4 101 35	4 101 87	16	1.5
1	4 101 36	4 101 88	20	1.5
1	4 101 37	4 101 89	25	1.5
1	4 101 38	4 101 90	32	1.5
1	4 101 39	4 101 91	40	1.5
1	4 101 40	4 101 92	50	1.5
1	4 101 41	4 101 93	63	1.5

Pack	Cat.Nos		2-pole - 230/400 V <sub>~</sub>	
	C curve	D curve	Nominal rating I <sub>n</sub> (A)	Number of modules
1	4 101 47	4 101 99	10	3
1	4 101 48	4 102 00	16	3
1	4 101 49	4 102 01	20	3
1	4 101 50	4 102 02	25	3
1	4 101 51	4 102 03	32	3
1	4 101 52	4 102 04	40	3
1	4 101 53		50	3
1	4 101 54		63	3

Pack	Cat.Nos		3-pole - 400 V <sub>~</sub>	
	C curve	D curve	Nominal rating I <sub>n</sub> (A)	Number of modules
1	4 101 60	4 102 12	10	4.5
1	4 101 61	4 102 13	16	4.5
1	4 101 62	4 102 14	20	4.5
1	4 101 63	4 102 15	25	4.5
1	4 101 64	4 102 16	32	4.5
1	4 101 65	4 102 17	40	4.5
1	4 101 66	4 102 18	50	4.5
1	4 101 67	4 102 19	63	4.5

Pack	Cat.Nos		4-pole - 400 V <sub>~</sub>	
	C curve	D curve	Nominal rating I <sub>n</sub> (A)	Number of modules
1	4 101 73	4 102 25	10	6
1	4 101 74	4 102 26	16	6
1	4 101 75	4 102 27	20	6
1	4 101 76	4 102 28	25	6
1	4 101 77	4 102 29	32	6
1	4 101 78	4 102 30	40	6
1	4 101 79	4 102 31	50	6
1	4 101 80	4 102 32	63	6

For detailed dimensions, **see e-catalogue**



## Add-on modules DX<sup>3</sup>

for 1 module/pole DX<sup>3</sup> MCBs



4 104 01



4 104 71



4 105 55

Technical characteristics **see e-catalogue**

Conform to IEC 61009-1

- AC type : detect AC components faults
- A type : detect AC and DC component faults
- Hpi type : detect faults with AC and DC components, increased immunity to false tripping

For mounting on the right-hand side of 1 module per pole DX<sup>3</sup> MCBs

Pack	Cat.Nos	2-pole - 230 V $\sim$			Pack	Cat.Nos	4-pole - 400 V $\sim$		
		<b>AC Type</b>					<b>AC Type</b>		
		Sensitivity (mA)	Nominal rating In (A)	Number of modules			Sensitivity (mA)	Nominal rating In (A)	Number of modules
1	4 104 01	30	40	2	1	4 104 99	30	40	3
1	4 104 02	30	63	2	1	4 105 00	30	63	3
1	4 104 13	300	40	2	1	4 105 11	300	40	3
1	4 104 14	300	63	2	1	4 105 12	300	63	3
1	4 104 24	300 selective	63	2	1	4 105 21	300 selective	63	3
1	4 104 26	1000 selective	63	2	1	4 105 23	1000 selective	63	3
		<b>A Type</b>					<b>A Type</b>		
1	4 104 28	30	40	2	1	4 105 25	30	40	3
1	4 104 29	30	63	2	1	4 105 26	30	63	3
1	4 104 31	300	40	2	1	4 105 28	300	40	3
1	4 104 32	300	63	2	1	4 105 29	300	63	3
		<b>Hpi Type</b>					<b>Hpi Type</b>		
1	4 104 35	30	63	2	1	4 105 31	300 selective	63	3
		<b>3-pole - 400 V<math>\sim</math></b>					<b>Hpi Type</b>		
		<b>AC Type</b>			1	4 105 34	30	63	3
		Sensitivity (mA)	Nominal rating In (A)	Number of modules	1	4 105 55	300 selective	63	3
1	4 104 71	30	40	3					
1	4 104 72	30	63	3					
1	4 104 74	300	40	3					
1	4 104 75	300	63	3					
1	4 104 77	300 selective	63	3					
		<b>A Type</b>							
1	4 104 80	30	63	3					
1	4 104 83	300	63	3					
		<b>Hpi Type</b>							
1	4 104 86	30	63	3					

## Add-on modules DX<sup>3</sup>

for 1.5 module/pole DX<sup>3</sup> MCBs



4 106 43

4 106 59

Technical characteristics [see e-catalogue](#)

Conform to IEC 61009-1

- AC type : detect AC components faults
- Hpi type : detect faults with AC and DC components, increased immunity to false tripping

For mounting on the right-hand side of 1.5 module per pole DX<sup>3</sup> MCBs

Pack	Cat.Nos	2-pole - 230 V $\sim$		
<b>AC Type</b> <b>30 mA</b>				
		Sensitivity (mA)	Nominal rating In (A)	Number of modules
1	4 105 68	30	125	4
1	4 105 71	300	125	4
<b>Hpi Type</b> <b>adjustable</b>				
1	4 105 76	30	63	2
1	4 105 78	30	125	4
1	4 105 82	300	125	4
<b>Hpi Type</b> <b>adjustable</b>				
1	4 105 83	from 300 to 1000	63	4
<b>3-pole - 400 V<math>\sim</math></b>				
<b>Hpi Type</b> <b>adjustable</b>				
		Sensitivity (mA)	Nominal rating In (A)	Number of modules
1	4 106 05	30	63	3
1	4 106 08	300	63	3
<b>Hpi Type</b> <b>adjustable</b>				
1	4 106 11	from 300 to 1000	63	6
<b>4-pole - 400 V<math>\sim</math></b>				
<b>AC Type</b>				
		Sensitivity (mA)	Nominal rating In (A)	Number of modules
1	4 106 25	30	125	6
1	4 106 29	300	125	6
<b>Hpi Type</b>				
1	4 106 36	30	63	3
1	4 106 38	30	125	6
1	4 106 40	300	63	3
1	4 106 42	300	125	6
<b>Hpi Type</b> <b>adjustable</b>				
1	4 106 43	from 300 to 1000	63	6
<b>4-pole 400 V<math>\sim</math> - Metering</b>				
LCD display For displaying active energy, instantaneous power and current per phase (A) consumption				
<b>Hpi type</b> <b>with integrated energy meter</b>				
		Sensitivity (mA)	Nominal rating (A)	Number of modules
1	4 106 57	30 à 3000	63	7.5
1	4 106 58	30 à 3000	125	7.5
<b>4-pole 400 V<math>\sim</math> - Measurement</b>				
LCD display For displaying current per phase, voltage, frequency, active and reactive power, power factor, active and reactive energy consumption and harmonics				
<b>Hpi type</b> <b>with integrated measurement control unit</b>				
		Sensitivity (mA)	Nominal rating (A)	Number of modules
1	4 106 59	30 à 3000	125	7.5

## Add-on modules DX<sup>3</sup>

### Compatibility MCBs/add-on modules

Breaking capacity	Curve	Number of poles	Add-on module for 1 module/pole MCBs	Add-on module for 1.5 module/pole MCBs
6000 / 10 kA	B, C, D	2P, 3P, 4P	All range	-
10000 / 16 kA	B, C, D	2P, 3P, 4P	In ≤ 63 A	In ≥ 80 A
		3P, 4P	In ≤ 25 A	In ≥ 32 A
	B, C, Z	2P	In ≤ 32 A	In ≥ 40 A
		3P, 4P	In ≤ 10 A	In ≥ 12,5 A
25 kA	D	2P	In ≤ 25 A	In ≥ 32 A
		3P, 4P	In ≤ 10 A	In ≥ 12,5 A
50 kA	B, C, D	2P, 3P, 4P	-	All range

### Adjustable add-on modules, Hpi type

Easy to access settings on front panel with sealable transparent cover  
Sensitivity: 300, 500 and 1000 mA  
Time delay: instantaneous, selective (60 ms) or delayed (150 ms)



### Hpi add-on modules with integrated metering unit or measurement control unit

Conform to standards EN 61009-1, EN 60947-2 and 61557-12 (PMD/DD/K55)

Electronic settings on the front panel  
Sensitivity: 30, 300, 1000, 3000 mA  
Time delay: instantaneous, or delayed (300 ms, 1 s, 3 s)

For integration in the EDMX<sup>3</sup> display and supervision system with interface Cat.No 4 210 75 (p. 85), to feed back information and the status of the remote MCB.

Precision: EN 61557-12 Class 1

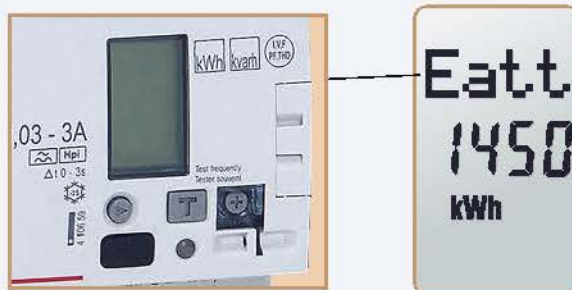

For detailed dimensions, [see e-catalogue](#)



# Signalling and remote tripping auxiliaries DX<sup>3</sup>



Pack	Cat.Nos	Signalling auxiliaries prong busbar adapted	Pack	Cat.Nos	Remote tripping auxiliaries	
1	4 062 58	<p>To fit on the left-hand side of DX<sup>3</sup> and TX<sup>3</sup> devices Maximum number of auxiliaries per device: - 3 signalling auxiliaries or - 2 signalling auxiliaries + 1 remote tripping auxiliary Allow insertion of the supply busbar, top side No tool required for joining together the auxiliary and the main device.</p> <p><b>Auxiliary contact</b> 6 A - 250 V~ (changeover switch) For MCBs, RCBOs, RCCBs, isolating switches or remote trip isolating switches Indicates the position of the contacts of its associated device.</p>	0.5	1	4 062 76	<p>To fit on the left-hand side of DX<sup>3</sup> and TX<sup>3</sup> devices Maximum 1 remote tripping auxiliary per device Allow insertion of the supply busbar No tool required for joining together the auxiliary and the main device. For MCBs, RCBOs, RCCBs and remote trip isolating switches</p> <p><b>Current shunt trips</b> For remote tripping of its associated device via a N/O push button</p>
1	4 062 60	<p><b>Fault signalling contact</b> 6 A - 250 V~ (changeover switch) For MCBs, RCBOs, RCCBs, Indicates the fault tripping of its associated device</p>	0.5	1	4 062 78	<p>12 to 48 V~/=</p> <p>110 to 415 V~</p>
1	4 062 62	<p><b>Auxiliary or fault signalling contact</b> 6 A - 250 V~ (changeover switch) For MCBs, RCBOs, RCCBs Allows the choice between the two functions</p>	0.5	1	4 062 80	<p>24 to 48 V~/=</p>
1	4 062 66	<p><b>Auxiliary + fault signalling contact or auxiliary contact + auxiliary contact</b> 6 A - 250 V~ (changeover switch) For MCBs, RCBOs, RCCBs</p>	1	1	4 062 82	<p>230 V~</p>
1	4 062 50	<p><b>Signalling auxiliaries fork busbar adapted</b> To fit on the left-hand side of DX<sup>3</sup> and TX<sup>3</sup> devices Maximum number of auxiliaries per device: - 3 signalling auxiliaries or - 2 signalling auxiliaries + 1 remote tripping auxiliary Allow insertion of supply busbar, bottom side No tool required for joining together the auxiliary and the main device.</p> <p><b>Auxiliary contact</b> 6 A - 250 V~(changeover switch) For MCBs, RCBOs, RCCBs, isolating switch or remote trip isolating switch Indicates the position of the contacts of its associated device</p>	0.5	1	4 062 86	<p><b>Power overvoltage protection (POP)</b> Protects the circuit by tripping its associated device in case of overvoltage between phase and neutral. Tripping threshold : 275 V (eg. in case of neutral failure)</p>
1	4 062 52	<p><b>Fault signalling contact</b> 6 A - 250 V~ (changeover switch) For MCBs, RCBOs, RCCBs, Indicates the fault tripping of its associated device</p>	0.5	1	4 062 87	<p><b>Autonomous shunt trip for N/C push-button</b> 230 V~ For remote tripping with positive security on a control circuit via a N/C push-button or emergency stop. Does not trigger its associated device in case of mains power failure (the trigger occurs only after a deliberate action of a N/C push-button). Supplied with battery Minimum working reserve : 60 hours (for remote tripping even if there is no supply voltage)</p>
1	4 062 56	<p><b>Auxiliary or fault signalling contact</b> 6 A - 250 V~ (changeover switch) For MCBs, RCBOs, RCCBs Allows the choice between the two functions</p>	0.5	1	4 062 85	<p>Spare battery for autonomous shunt trip Cat.No 4 062 87</p>
1	4 062 64	<p><b>Auxiliary + fault signalling contact or auxiliary contact + auxiliary contact</b> 6 A - 250 V~ (changeover switch) For MCB, RCBOs, RCCBs</p>	1			1.5

## Motorised controls DX<sup>3</sup>, STOP&GO automatic resetting



4 062 91

4 062 92

4 062 88



## Manual supply inverter DX<sup>3</sup> and accessories



4 063 14

4 063 19

Pack	Cat.Nos	Motorised controls																
1	4 062 90	<p>For remote control (opening and closing) of their associated device. To fit on the left-hand side of DX<sup>3</sup> and TX<sup>3</sup> devices For MCBs, RCBOs, RCCBs and remote trip isolating switches (from 1P to 4P) Can take one control auxiliary and one signalling auxiliary. No tool required for joining together the motorised control and the main device</p> <p><b>ON/OFF function - for 1 module / pole devices (In up to 63 A)</b></p> <table border="1"> <thead> <tr> <th>Control voltage</th> <th>Number of modules</th> </tr> </thead> <tbody> <tr> <td>24-48 V~/=</td> <td>1</td> </tr> <tr> <td>230 V~</td> <td>1</td> </tr> </tbody> </table> <p><b>ON/OFF function - for 1.5 module / pole devices (In up to 125 A)</b></p> <table border="1"> <thead> <tr> <th>Control voltage</th> <th>Number of modules</th> </tr> </thead> <tbody> <tr> <td>230 V~</td> <td>1</td> </tr> </tbody> </table> <p><b>ON/OFF + automatic resetting function - for 1 module / pole devices (In up to 63 A)</b> Automatically resets the device to which it is associated, thus ensuring continuity of service</p> <table border="1"> <thead> <tr> <th>Control voltage</th> <th>No. of modules</th> </tr> </thead> <tbody> <tr> <td>24-48 V~/=</td> <td>2</td> </tr> <tr> <td>230 V~</td> <td>2</td> </tr> </tbody> </table>	Control voltage	Number of modules	24-48 V~/=	1	230 V~	1	Control voltage	Number of modules	230 V~	1	Control voltage	No. of modules	24-48 V~/=	2	230 V~	2
Control voltage	Number of modules																	
24-48 V~/=	1																	
230 V~	1																	
Control voltage	Number of modules																	
230 V~	1																	
Control voltage	No. of modules																	
24-48 V~/=	2																	
230 V~	2																	
1	4 062 91																	
1	4 062 92																	
1	4 062 93																	
1	4 062 95																	
		<b>STOP&amp;GO automatic resetting</b>																
		For automatic resetting of 1 module per pole RCCBs and RCBOs up to 63 A STOP&GO is used in the event of unwanted tripping generated by temporarily electrical disturbances or other external events. Can take one control auxiliary and one signalling auxiliary. The signalling auxiliary must be placed between the STOP&GO and the control auxiliary. No tool required for assembling																
		<b>Automatic resetting function</b>																
		<table border="1"> <thead> <tr> <th>Control voltage</th> <th>No. of modules</th> </tr> </thead> <tbody> <tr> <td>230 V~</td> <td>2</td> </tr> </tbody> </table>	Control voltage	No. of modules	230 V~	2												
Control voltage	No. of modules																	
230 V~	2																	
		<b>Automatic resetting + periodic self-test function</b>																
		<table border="1"> <thead> <tr> <th>Control voltage</th> <th>No. of modules</th> </tr> </thead> <tbody> <tr> <td>230 V~</td> <td>2</td> </tr> </tbody> </table>	Control voltage	No. of modules	230 V~	2												
Control voltage	No. of modules																	
230 V~	2																	

Pack	Cat.Nos	Manual supply inverter (MSI)
		For manually switching between the mains and an alternative power supply. Allow to restore power on pre-designated and/or critical circuits in case of a power failure of the main supply.
		<b>N</b> For DX <sup>3</sup> MCBs and remote trip isolating switches Installation principle - see e-catalogue
1	4 063 14	For 2P 2-module devices
1	4 063 15	For 3P 3-module devices
1	4 063 16	For 4P 4-module devices
		<b>Front external rotary handles</b>
		Allow the manual control (open/close) of a modular device without opening the enclosure For all DX <sup>3</sup> , TX <sup>3</sup> and RX <sup>3</sup> devices from 2P upwards Supplied with bracket, connection rod, handle, self-adhesive drilling template and connection accessories
		<b>N</b> Installation principle - see e-catalogue
1	4 063 19	Black handle
1	4 063 20	Yellow and red handle
		<b>Wiring management accessories</b>
		<b>Insulating shields</b>
		For 1 module per pole MCBs For separation between the terminals of the MCB, when using high cross section cables
1	4 063 05	
		<b>Spacing unit with feedthrough</b>
		0.5 module Allows cables to run between two modular devices and creates an air channel in order to limit temperature rise
10	4 063 07	
		<b>Terminals for aluminium cables</b>
		For 1.5 module/pole MCBs up to 63 A
1	4 063 10	
1	4 063 11	For 1.5 module/pole MCBs and remote trip isolating switches from 80 A to 125 A
		<b>Safety and maintenance accessories</b>
		<b>Sealable screw covers</b>
		For 1 module per pole MCBs (set of 4)
2	4 063 04	
1	4 063 12	For 1.5 module per pole MCBs (set of 4)
		<b>Terminal shield</b>
		For 1.5 module/pole MCBs (set of 2)
1	4 063 06	
		<b>Padlocking</b>
		To lock the handle of a modular device during maintenance
		Large padlock, Ø6 mm, 50 mm length Supplied with two keys and labels
1	0 227 97	
		Small padlock, Ø5 mm
3	4 063 13	
2	4 063 03	Support for one padlock (for small or large model) For locking the handle of the modular devices (MCBs, RCCBs, RCBOs or isolating switches) in OFF position



## Select your Voltage Surge Protector and its corresponding protection

STEP 1 Define the type of building		STEP 2 Define the risk level and the network type		STEP 3 + 4 Optimize protection against lightning effects (V.S.P. cascading <sup>(1)</sup> ) and Protect the installation against short-circuits and overloads			
				LEVEL 1 MAIN BOARD		LEVEL 2 DISTRIBUTION BOARD	
RESIDENTIAL BUILDINGS AND SMALL OFFICES	RISK LEVEL	NETWORK TYPE	V.S.P. + CORRESPONDING PROTECTION $I_{cc} \leq 6 \text{ kA}$		V.S.P. + CORRESPONDING PROTECTION $I_{cc} \leq 6 \text{ kA}$		
 <b>INDIVIDUAL HOUSES</b>	Very high 	2P	2 x 0 039 10 + 0 034 37	+	0 039 41 + 0 034 34		
		3P	3 x 0 039 10 + 0 034 55		3 x 0 039 40 + 0 034 52		
		4P	4 x 0 039 10 + 0 034 97		0 039 43 + 0 034 94		
 <b>AND</b> <b>BLOCKS OF FLATS</b>	High 	2P	0 039 31 + 0 034 34	+	0 039 41 + 0 034 34		
		3P	0 039 32 + 0 034 52		3 x 0 039 40 + 0 034 52		
		4P	0 039 33 + 0 034 94		0 039 43 + 0 034 94		
 <b>AND</b> <b>SMALL OFFICES</b>	Medium 	2P	0 039 41 + 0 034 34	+	0 039 41 + 0 034 34		
		3P	3 x 0 039 40 + 0 034 52		3 x 0 039 40 + 0 034 52		
		4P	0 039 43 + 0 034 94		0 039 43 + 0 034 94		
OFFICES AND INDUSTRIAL BUILDINGS	RISK LEVEL	NETWORK TYPE	V.S.P. + ASSOCIATED PROTECTION $I_{cc} \leq 50 \text{ kA}$		V.S.P. + ASSOCIATED PROTECTION $I_{cc} \leq 25 \text{ kA}$		
 <b>OFFICE BUILDINGS</b>	Very high 	2P	2 x 0 030 00 + 2 x 0 173 65 (T1)	+	0 039 31 + 4 097 69		
		3P	0 030 22 + 3 x 0 173 65 (T1) (IT earthing system: 3 x 0 030 00 + 3 x 0 173 65 (T1))		0 039 32 + 4 097 82		
		4P	0 030 23 + 3 x 0 173 65 (T1) (IT+N earthing system: 4 x 0 030 00 + 4 x 0 173 65 (T1))		0 039 33 + 4 097 95		
 <b>AND</b> <b>INDUSTRIAL BUILDINGS</b>	High 	2P	0 039 21 + 4 101 52	+	0 039 31 + 4 097 69		
		3P	0 039 22 + 4 101 65		0 039 32 + 4 097 82		
		4P	0 039 23 + 4 101 78		0 039 33 + 4 097 95		
	Medium 	2P	0 039 21 + 4 101 52	+	0 039 31 + 4 097 69		
		3P	0 039 22 + 4 101 65		0 039 32 + 4 097 82		
		4P	0 039 23 + 4 101 78		0 039 33 + 4 097 95		

1: A correct protection can not be achieved with level 1 V.S.P. only (at least two levels are needed)



## Select your Voltage Surge Protector and its corresponding protection

		<b>LEVEL 3 PROXIMITY</b>			<b>COMMUNICATION LINES</b>
		 Cat.No 0 775 40			
		<b>PROXIMITY V.S.P.</b>			<b>INSIDE COMMUNICATION DISTRIBUTION BOX</b>
		<b>+</b> Mosaic Programme Cat.No 0 775 40 (p. 794) or Multioutlet extensions Cat.Nos 6 946 51/56 (p. 578)			Protection of all the lines entering the building is strongly recommended (including communication lines: telephone, data, etc.)
		<b>PROXIMITY V.S.P.</b>			<b>INSIDE COMMUNICATION DISTRIBUTION BOX</b>
		<b>+</b> Mosaic Programme Cat.No 0 775 40 (p. 794) or Multioutlet extensions Cat.Nos 6 946 51/56 (p. 578)			Protection of all the lines entering the building is strongly recommended (including communication lines: telephone, data, etc.)

For a complete protection all incoming lines (entering into the buildings) should be protected with V.S.Ps (including telephone and data lines)

### Define the risk level (STEP 2)

Irrespective of the requirements in the standards, the use of a voltage surge protector is strongly recommended in most cases (production losses, safety services, cost of equipment, etc.). Voltage surge protectors can be chosen for any type of installation based on the risk levels, which are defined as follows:

Risk level:



- Very high risk: installation equipped with external lightning conductors (L.P.S.), with a metallic structure higher than surrounding buildings (or any object that can act as a lightning conductor), an installation that is isolated and located at a high point (top of mountains), or an installation that has been subject to previous lightning strikes

**IEC 60364: V.S.P. compulsory at the origin of the installation (main board) with L.P.S. (lightning protection system)**



- High risk: installation with overhead power supply, in a mountainous area, isolated, at the end of a line, near a body of water, trees, etc.

**IEC 60364: V.S.P. compulsory with overhead lines in AQ2 areas (see p. 65)**



- Medium risk: other types of installation (installations in urban areas, in low, flat areas and low and medium height mountainous areas, underground power supplies, etc.)

### Optimize protection (STEP 3)

Protection of an installation against transient overvoltages can only generally be guaranteed with several levels of voltage surge protectors used together in cascade (see e-catalogue). In addition to the energy aspect explained below, 2 or 3 levels of voltage surge protectors are in fact usually necessary in order to limit overvoltages connected with the fact that lightning is a high frequency phenomenon. In order to limit overvoltages as much as possible, a voltage surge protector must always be installed as close as possible to the equipment to be protected. However, proximity protection (Level 3) on its own can only protect the equipment connected to it downstream, and above all, it cannot adequately limit the energy. To do this, a voltage surge protector is necessary at the head of the installation (Level 1) to shunt the majority of the energy to earth.

Likewise, a voltage surge protector on its own at the head of the installation (Level 1) cannot protect the whole installation and the equipment connected to it, due to the fact that it allows residual energy to pass and that lightning is a high frequency phenomenon (see e-catalogue).

For these reasons, depending on the scale of the installation and the types of risk (exposure and sensitivity of equipment, criticality of continuity of service), circuit protection (Level 2) is necessary in addition to protection of the head of the installation.

### Protect the installation against short-circuit and overloads (STEP 3)

The supply circuit of the VSP must always be protected against short-circuits and overloads by its associated protection device in accordance with discrimination rules.

Select the corresponding MCB with the short-circuit rating adapted to your installation requirements.

V.S.P. Cat.No	0 039 10/20/21/22/23			0 039 30/31/32/33/40/41/43		
	2P	3P	4P	2P	3P	4P
Type	2P	3P	4P	2P	3P	4P
Caliber	40 A	40 A	40 A	20 A	20 A	20 A
≤ 6 kA	0 034 37	0 034 55	0 034 97	0 034 34	0 034 52	0 034 94
≤ 10 kA	4 078 04	4 078 63	4 079 32	4 078 01	4 078 60	4 079 29
≤ 16 kA	4 092 06	4 092 58	4 093 40	4 092 03	4 092 55	4 093 37
≤ 25 kA	4 097 72	4 097 85	4 097 98	4 097 69	4 097 82	4 097 95
≤ 50 kA	4 101 52	4 101 65	4 101 78	not allowed	not allowed	not allowed

Associated protection possible with all types of modular MCBs (DX-E and DX<sup>3</sup>) if rated 20A or 40A as above stated. For association with 36kA MCBs, please consult us. Protection of VSPs can not be done with ACBs or MCCBs (DPX<sup>3</sup> or DMX<sup>3</sup> for example) and an extra protection.

## Voltage surge protectors low voltage type 1 (class I / B)



0 030 23



0 030 28

Technical characteristics and dimensions [see e-catalogue](#)

Type 1 voltage surge protectors (V.S.P.) for main distribution boards  
 Conform to standards IEC 61643-1 and EN 61643-11  
 3 different impulse discharge ratings  
 For 230/400 V~ - 50/60 Hz networks  
 Especially for use in installations at very high risk and/or with external lightning protection of the building

Pack	Cat.Nos	Main board protection						
1	0 030 00	<b>High lightning protection - H - Iimp = 50 kA</b> For power installations Earthing system: TT, TN, IT No plug-in module <table border="1"> <thead> <tr> <th>Number of poles</th> <th>Corresponding protection</th> <th>Number of modules</th> </tr> </thead> <tbody> <tr> <td>1P</td> <td>gG type - max. 250 A</td> <td>2</td> </tr> </tbody> </table>	Number of poles	Corresponding protection	Number of modules	1P	gG type - max. 250 A	2
Number of poles	Corresponding protection	Number of modules						
1P	gG type - max. 250 A	2						
1	0 030 22	<b>Increased lightning protection - E - Iimp = 25 kA</b> For power installations Consist of a base and a plug-in replacement module provided with a status indicator • Green: surge protector operational • Red: module needs replacing Fitted with built-in thermal protection Equipped with auxiliary contacts for remote monitoring Reversible product, allowing connexion from the top or bottom <table border="1"> <thead> <tr> <th>Number of poles</th> <th>Corresponding protection</th> <th>Number of modules</th> </tr> </thead> <tbody> <tr> <td>3P</td> <td>gG type - max. 250 A</td> <td>6</td> </tr> </tbody> </table>	Number of poles	Corresponding protection	Number of modules	3P	gG type - max. 250 A	6
Number of poles	Corresponding protection	Number of modules						
3P	gG type - max. 250 A	6						
1	0 030 23	TNC earthing system 4P TT, TNS earthing system <table border="1"> <thead> <tr> <th>Number of poles</th> <th>Corresponding protection</th> <th>Number of modules</th> </tr> </thead> <tbody> <tr> <td>4P</td> <td>gG type - max. 250 A</td> <td>8</td> </tr> </tbody> </table>	Number of poles	Corresponding protection	Number of modules	4P	gG type - max. 250 A	8
Number of poles	Corresponding protection	Number of modules						
4P	gG type - max. 250 A	8						
1	0 039 10 <sup>1</sup>	<b>Standard lightning protection - S - Iimp = 12.5 kA</b> For all types of installations Equipped with status indicator: • Green: surge protector operational • Orange: needs replacing No plug-in module <table border="1"> <thead> <tr> <th>Number of poles</th> <th>Corresponding protection</th> <th>Number of modules</th> </tr> </thead> <tbody> <tr> <td>1P</td> <td>40 A - C curve</td> <td>2</td> </tr> </tbody> </table>	Number of poles	Corresponding protection	Number of modules	1P	40 A - C curve	2
Number of poles	Corresponding protection	Number of modules						
1P	40 A - C curve	2						
1	0 030 28	<b>Replacement modules for type 1 V.S.P.</b> For V.S.P. Cat.Nos 0 030 20/22/23						
1	0 030 29	For V.S.P. Cat.No 0 039 23 (N-PE module)						

1: Corresponding protection: DX and DX<sup>3</sup> MCBs or equivalent ranges according to required breaking capacity

## Voltage surge protectors low voltage type 2 (class II / C)



0 039 21

Technical characteristics and dimensions [see e-catalogue](#)

Type 2 voltage surge protectors (V.S.P.) for main boards, distribution boards and consumer units  
 Conform to standards IEC 61643-1 and EN 61643-11  
 3 different impulse discharge ratings  
 For 230/400 V~ - 50/60 Hz networks

Pack	Cat.Nos	Main board protection															
1	0 039 20 <sup>1</sup>	<b>High protection - H - Class I + II I<sub>max</sub> = 70 kA</b> Earthing systems: TT, TN, IT Consist of a base and a plug-in replacement module provided with a status indicator • Green: surge protector operational • Orange: module needs replacing Can be equipped with auxiliary contacts for remote monitoring purpose (p. 65) <table border="1"> <thead> <tr> <th>Number of poles</th> <th>Corresponding protection</th> <th>Number of modules</th> </tr> </thead> <tbody> <tr> <td>1P</td> <td>40A - C curve</td> <td>1</td> </tr> <tr> <td>2P</td> <td>40A - C curve</td> <td>2</td> </tr> <tr> <td>3P</td> <td>40A - C curve</td> <td>3</td> </tr> <tr> <td>4P</td> <td>40A - C curve</td> <td>4</td> </tr> </tbody> </table>	Number of poles	Corresponding protection	Number of modules	1P	40A - C curve	1	2P	40A - C curve	2	3P	40A - C curve	3	4P	40A - C curve	4
Number of poles	Corresponding protection		Number of modules														
1P	40A - C curve		1														
2P	40A - C curve		2														
3P	40A - C curve	3															
4P	40A - C curve	4															
1	0 039 21 <sup>1</sup>																
1	0 039 22 <sup>1</sup>																
1	0 039 23 <sup>1</sup>																
1	0 039 30 <sup>1</sup>	<b>Distribution board protection</b> For electrical equipments located at more than 10 m from the main distribution board Consist of a base and a plug-in replacement module provided with a status indicator • Green: surge protector operational • Orange: module needs replacing Can be equipped with auxiliary contacts for remote monitoring purpose (p. 65) <b>Increased protection - E - Class II - I<sub>max</sub> = 40 kA</b> Earthing systems: TT, TN, IT <table border="1"> <thead> <tr> <th>Number of poles</th> <th>Corresponding protection</th> <th>Number of modules</th> </tr> </thead> <tbody> <tr> <td>1P</td> <td>20A - C curve</td> <td>1</td> </tr> <tr> <td>2P</td> <td>20A - C curve</td> <td>2</td> </tr> <tr> <td>3P</td> <td>20A - C curve</td> <td>3</td> </tr> <tr> <td>4P</td> <td>20A - C curve</td> <td>4</td> </tr> </tbody> </table>	Number of poles	Corresponding protection	Number of modules	1P	20A - C curve	1	2P	20A - C curve	2	3P	20A - C curve	3	4P	20A - C curve	4
Number of poles	Corresponding protection		Number of modules														
1P	20A - C curve		1														
2P	20A - C curve		2														
3P	20A - C curve	3															
4P	20A - C curve	4															
1	0 039 31 <sup>1</sup>																
1	0 039 32 <sup>1</sup>																
1	0 039 33 <sup>1</sup>																
1	0 039 40 <sup>1</sup>	<b>Increased protection - S - Class II - I<sub>max</sub> = 15 kA</b> Earthing systems: TT, TN <table border="1"> <thead> <tr> <th>Number of poles</th> <th>Corresponding protection</th> <th>Number of modules</th> </tr> </thead> <tbody> <tr> <td>1P</td> <td>20A - C curve</td> <td>1</td> </tr> <tr> <td>2P</td> <td>20A - C curve</td> <td>2</td> </tr> <tr> <td>4P</td> <td>20A - C curve</td> <td>4</td> </tr> </tbody> </table>	Number of poles	Corresponding protection	Number of modules	1P	20A - C curve	1	2P	20A - C curve	2	4P	20A - C curve	4			
Number of poles	Corresponding protection		Number of modules														
1P	20A - C curve		1														
2P	20A - C curve	2															
4P	20A - C curve	4															
1	0 039 41 <sup>1</sup>																
1	0 039 43 <sup>1</sup>																
5	0 039 28	<b>Replacement modules for type 2 V.S.P.</b> For V.S.P. Cat.Nos 0 039 20/21/22/23															
5	0 039 34	For V.S.P. Cat.Nos 0 039 30/31/32/33															
5	0 039 44	For V.S.P. Cat.Nos 0 039 40/41/43															
5	0 039 39	For V.S.P. Cat.Nos 0 039 35/36/38 (old model voltage surge protector)															

1: Corresponding protection: DX and DX<sup>3</sup> MCBs or equivalent ranges according to required breaking capacity

## Voltage surge protectors for telephone lines and accessories for low voltage V.S.P.



0 038 28

Technical characteristics and dimensions **see e-catalogue**

Pack	Cat.Nos	Voltage surge protector for telephone and data lines	Un (V)	Up (V)
		Recommended for complete protection of installations already equipped with low voltage V.S.P. on power lines (standard IEC 60364) For protection of: telephone, fax, modem, etc., connected to the incoming telephone line, against overvoltages of atmospheric origin Installed in a distribution cabinet, especially the ELV signal cabinet Cat.No 0 011 95 (please consult us), or terminal shield boxes 1 module (p. 190) Connected in series with the telephone line Provided with a status indicator • green: surge protector operational • orange: surge protector needs replacing Conform to standards EN 61643-21 and IEC 61643-21 Imax: 10 kA and In: 5 kA (8/20)		
1	0 038 28	Analogue (RTC and ADSL)	170	260
1	0 038 29	Digital (signal lines, current loops)	48	100
		<b>Signalling auxiliaries for low voltage V.S.P.</b> With changeover microswitch 2 A - 250 V~ Mounted on the backside of the surge protector (except Cat.No 0 039 10)		
1	0 039 56	For 2-pole module V.S.P.		
1	0 039 57	For 3-pole module V.S.P.		
1	0 039 58	For 4-pole module V.S.P.		
		<b>Decoupling inductors</b> Enable coordination between 2 V.S.P. in the same board, when minimum distance to insure proper V.S.P. coordination can not be respected For multipole voltage surge protectors, each conductor (including the neutral conductor) must be equipped with one decoupling inductor		
1	0 039 62	Module for circuit 35 A - 500 V~		2
1	0 039 63	Module for circuit 63 A - 500 V~		4

Proximity protection  
p. 578 and 794



## Voltage surge protectors

### Protection against lightning effects

Lightning directly or indirectly generates the following effects:

- thermal (blow-outs, fire)
- electrodynamic (loosening of terminals)
- rise in earth voltage (risk of electrocution)
- overvoltages of several thousand volts and destructive induced currents (damage to electrical and electronic equipment, interruption of operation)

Protection against the effects of lightning is based essentially on:

- catching and discharging the current to earth
- the use of voltage surge protectors
- the passive protection of the installation

Passive protection (poor, good) designates the part of the protection provided by the structure and the configuration of the installation itself (neutral earthing system, area, level of equipotentiality, etc.)

### Voltage surge protectors and regulation

Voltage surge protector enable:

- protect sensitive devices against direct and indirect effects of lightning
- to limit harmful consequences on person security
- to insure the continuity of work

#### 1 - Product standards EN 61643-11 and IEC 61643-1

Voltage surge protectors are mainly classified in two levels (types):

EN 61643-11	Type 1 (T1)	Type 2 (T2)
IEC 61643-1	Class I (T1)	Class II (T2)
VDE 0675-6 <sup>(1)</sup>	Class B	Class C
Type of wave	10/350 µs	8/20 µs
Main characteristics	limp (10/350) In (8/20)	In, Imax

1: German standard VDE replaced by European standard EN 61643-11

The V.S.P. Cat.No 0 039 20/21/22/23 are classified in both levels, also called T1+T2 or B+C

#### 2 - Installation standards: IEC 60364 (or equivalent electric national standards)

According to articles 443 and 534, the use of VSPs is required in new or renovated buildings in the following cases:

- buildings equipped with lightning conductors: type 1 VSPs with  $I_n \geq 12.5$  kA
- buildings with overhead power supply in class AQ2 geographic zones (see map below: red zones): type 2 VSPs with  $I_n \geq 5$  kA
- buildings with medical services or equipped with safety systems (fire, etc.) in class AQ2 geographic zones: type 2 VSPs with  $I_n \geq 5$  kA

The use of VSPs is also strongly recommended in mountain areas, close to reaches of water or dominating structures (buildings, trees, etc.), in the cases of line end installations or installations located less than 50 m from buildings equipped with lightning conductors<sup>(2)</sup>  
When VSPs are present on the power circuit, it is strongly advised to install a VSP on the communication circuits (telephone or data lines...)

2: Lightning conductors: external protection of buildings against direct lightning impacts

### Choice of the level lightning protection

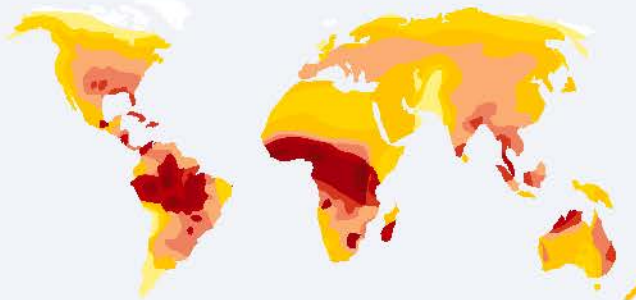

The annual average of stormy days (Nk)

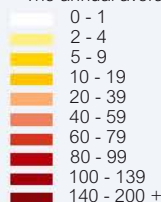

AQ2 areas :  $N_k > 25$   
IEC 60364 : V.S.P. mandatory for installations supplied with overhead low voltage lines and located in AQ2 areas

## Domestic fuse carriers

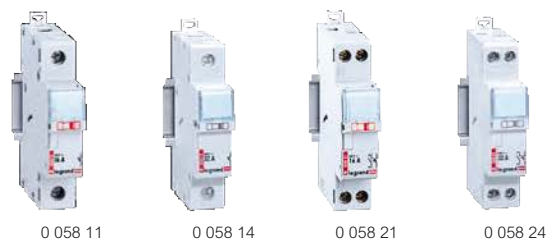

Dimensions **see e-catalogue**

With label-holders  
 With insulated carrier class II, padlockable  
 Coupling via supply busbars  
 Shielded terminals capacity 2 x 10 mm<sup>2</sup>  
 Possibility to signal indicator blown fuse  
 Fuse not supplied

Pack	Cat.Nos	For domestic cylindrical cartridge fuses		
		Conform to EN 60269-1 and IEC 60269-1,3		
		<b>Single pole</b>		
		For domestic cartridges	Cartridge dimensions (mm)	Number of modules
10	0 058 10	10 A - 230 V~	8.5 x 23	1
10	0 058 11	16 A	10.3 x 25.8	1
10	0 058 12	20 A - 400 V~	8.5 x 31.5	1
10	0 058 13	25 A	10.3 x 31.5	1
10	0 058 14	32 A	10.3 x 38	1
		<b>Single pole + neutral</b>		
10	0 058 20	10 A - 230 V~	8.5 x 23	1
10	0 058 21	16 A	10.3 x 25.8	1
10	0 058 22	20 A - 400 V~	8.5 x 31.5	1
10	0 058 23	25 A	10.3 x 31.5	1
10	0 058 24	32 A	10.3 x 38	1
		<b>For miniature cylindrical cartridge fuses</b>		
		Conform to EN 60127-6 and IEC 60127-6		
		To protect sensitive equipment: transformers, electronic equipment, etc.		
		<b>Single pole</b>		
		Cartridge dimensions (mm)	Voltage	Number of modules
5	0 058 00	5 x 20	250 V~	1
		<b>Single pole + neutral</b>		
5	0 058 02	5 x 20	250 V~	1

## Domestic cartridge fuses



Pack	Cat.Nos	Miniature type 5 x 20				
		Instant reaction fuse - Ceramic body Conform to EN/IEC 60127-2 High rupture capacity (A) For use with dimmers, Viking terminal blocks and emergency lightning units, transformers				
		Rating (Amps)	Voltage ~ (Volts)	Rupture capacity (Amps)		
10	0 102 02	0.2	250	1500		
10	0 102 05	0.5				
10	0 102 06	0.63				
10	0 102 10	1				
10	0 102 20	2				
10	0 102 30	3.15				
10	0 102 50	5				
10	0 102 63	6.3				
10	0 102 96 <sup>1</sup>	10				
		Rating (Amps)				Voltage ~ (Volts)
		<b>Cylindrical</b>				
		<b>6.3 x 23</b>				
10	Without indicator 0 103 06 <sup>2</sup>	6	230	6000	1.5	
		<b>8.5 x 23</b>				
10	0 114 06	6	230	6000	1.5	
10 100	0 113 10	10			1.5	
		<b>10.3 x 25.8</b>				
10	0 116 10 <sup>2</sup>	10	230	6000	2.5	
10	0 116 16 <sup>2</sup>	16			2.5	
		<b>8.5 x 31.5</b>				
10 100	0 123 20	20	400	20000	2.5	
		<b>10.3 x 31.5</b>				
10	0 126 16	16	400	20000	4	
10	0 126 20	20				
10	0 126 25	25				
		<b>10.3 x 38</b>				
10 100	0 133 32	32	400	20000	6	
10	0 134 32	32			6	
		<b>Neutral links</b>				
10	0 123 00	8 x 32 (previously 8.5 x 31.5)				
10	0 133 00	10 x 38				

1: Overrating not described by standards  
 2: Conform to BS 1361 (1971)

## Isolating fuse carriers



0 058 06



0 058 28



0 058 48

Dimensions **see e-catalogue**

Pack	Cat.Nos	<b>For industrial cylindrical cartridge fuses type aM or gG</b>		
		Conform to standard IEC 60269-2 Isolators conform to IEC 60947-3 Icc: - 20 kA with 8.5 x 31.5 cartridge fuse - 100 kA with 10 x 38 cartridge fuse Fuse not supplied (p. 159)		
		<b>Single pole</b>		
		Cartridge dimensions (mm)	Voltage	Number of modules
10	0 058 06 <sup>1</sup>	8.5 x 32	400 V~	1
10	0 058 08	10 x 38	500 V~	1
		<b>Single pole + neutral</b>		
10	0 058 16 <sup>1</sup>	8.5 x 32	400 V~	1
10	0 058 18	10 x 38	500 V~	1
		<b>2-pole</b>		
5	0 058 26 <sup>1</sup>	8.5 x 32	400 V~	2
5	0 058 28	10 x 38	500 V~	2
		<b>3-pole</b>		
3	0 058 36 <sup>1</sup>	8.5 x 32	400 V~	3
3	0 058 38	10 x 38	500 V~	3
		<b>3-pole + neutral</b>		
2	0 058 46 <sup>1</sup>	8.5 x 32	400 V~	4
2	0 058 48	10 x 38	500 V~	4
		<b>Accessoires</b>		
10	0 057 90	Blow-out indicator 250 V~		
1	0 057 96	Early break N/O + N/C contact auxiliary 5 A - 250 V~ (0.5 module)		
2	0 044 44	Sealable screw cover (4 separable poles)		

1: Previously 8.5 x 31.5 mm

## LEGRAND PACKAGING

# practical & eco-friendly

Legrand packaging – your assistance of a certified original product which is factory inspected, protected and clearly identifiable

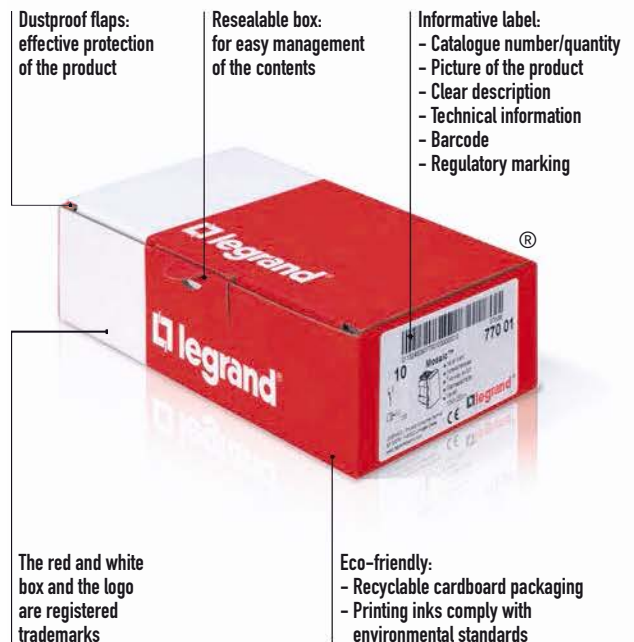

## MORE INFORMATION



[www.legrand-copytracer.com](http://www.legrand-copytracer.com)

Copytracer involves a unique registration number that appears on some of our products. This number is stored in a database and can be consulted on this website. By entering it you can immediately check whether or not the Copytracer number is consistent with your product.

# Pulse operated latching relays CX<sup>3</sup>



Dimensions **see e-catalogue**

Pack	Cat.Nos	Noiseless pulse operated latching relay																																							
1	4 124 00	<p>Conform to standard EN 60669-2-2</p> <p><b>Single pole - 16 A - 250 V<math>\sim</math></b></p> <table border="1"> <tr> <th>Control voltage</th> <th>Type of contact</th> <th>Connection</th> <th>Number of modules</th> </tr> <tr> <td>230 V</td> <td>1 N/O</td> <td></td> <td>1</td> </tr> </table>	Control voltage	Type of contact	Connection	Number of modules	230 V	1 N/O		1																															
Control voltage	Type of contact	Connection	Number of modules																																						
230 V	1 N/O		1																																						
1	4 124 01	<p><b>Delayed noiseless pulse operated latching relay</b></p> <p>Switch-off, pre-warning function Conform to standard EN 60669-2-2</p> <p><b>Single pole - 16 A - 250 V<math>\sim</math></b></p> <table border="1"> <tr> <th>Control voltage</th> <th>Type of contact</th> <th>Connection</th> <th>Number of modules</th> </tr> <tr> <td>230 V</td> <td>1 N/O</td> <td></td> <td>1</td> </tr> </table>	Control voltage	Type of contact	Connection	Number of modules	230 V	1 N/O		1																															
Control voltage	Type of contact	Connection	Number of modules																																						
230 V	1 N/O		1																																						
1	4 124 04	<p><b>Standard pulse operated latching relays</b></p> <p>Conform to standard EN 60669-2-2 Maximum 2 auxiliary devices per latching relay</p> <p><b>Single pole - 16 A - 250 V<math>\sim</math></b></p> <table border="1"> <tr> <th>Control voltage</th> <th>Type of contact</th> <th>Connection</th> <th>Number of modules</th> </tr> <tr> <td>12 V</td> <td>1 N/O</td> <td rowspan="3"></td> <td>1</td> </tr> <tr> <td>24 V</td> <td>1 N/O</td> <td>1</td> </tr> <tr> <td>230 V</td> <td>1 N/O</td> <td>1</td> </tr> </table> <p><b>2-pole - 16 A - 250 V<math>\sim</math></b></p> <table border="1"> <tr> <th>Control voltage</th> <th>Type of contact</th> <th>Connection</th> <th>Number of modules</th> </tr> <tr> <td>24 V</td> <td>2 N/O</td> <td rowspan="3"></td> <td>1</td> </tr> <tr> <td>48 V</td> <td>2 N/O</td> <td>1</td> </tr> <tr> <td>230 V</td> <td>2 N/O</td> <td>1</td> </tr> </table> <p><b>4-pole - 16 A - 250 V<math>\sim</math></b> Can be used for 3-pole assembly</p> <table border="1"> <tr> <th>Control voltage</th> <th>Type of contact</th> <th>Connection</th> <th>Number of modules</th> </tr> <tr> <td>24 V</td> <td>4 N/O</td> <td rowspan="2"></td> <td>2</td> </tr> <tr> <td>230 V</td> <td>4 N/O</td> <td>2</td> </tr> </table>	Control voltage	Type of contact	Connection	Number of modules	12 V	1 N/O		1	24 V	1 N/O	1	230 V	1 N/O	1	Control voltage	Type of contact	Connection	Number of modules	24 V	2 N/O		1	48 V	2 N/O	1	230 V	2 N/O	1	Control voltage	Type of contact	Connection	Number of modules	24 V	4 N/O		2	230 V	4 N/O	2
Control voltage	Type of contact		Connection	Number of modules																																					
12 V	1 N/O			1																																					
24 V	1 N/O	1																																							
230 V	1 N/O	1																																							
Control voltage	Type of contact	Connection	Number of modules																																						
24 V	2 N/O		1																																						
48 V	2 N/O		1																																						
230 V	2 N/O		1																																						
Control voltage	Type of contact	Connection	Number of modules																																						
24 V	4 N/O		2																																						
230 V	4 N/O		2																																						
10	0 491 20	<p><b>Surface mounting pulse operated latching relays</b></p> <p>10 A - 230 V<math>\sim</math> - 50/60 Hz Suitable for new installations or retrofitting of existing ones Compatible with electronic ballasts and fluocompact lamps Mounting on plate or in flush-mounting boxes Ø 67 mm Equipped with automatic terminals for flexible or rigid wires (max. 2.5 mm) Power : min. 7 W / max. 2300 W IP 20 - IK 04 Dimensions: 49 x 46 x 26 mm Maximum current when used with illuminated push-buttons : 50 mA</p> <p><b>Noiseless</b></p> <p>Single pole</p> <p>Single pole with timer Enables energy savings by switching off lighting after a specified period Time delay adjustment from 1 to 60 min. Switch-off pre-warning function (can be disabled)</p>																																							
10	0 491 21																																								

Pack	Cat.Nos	Signalling auxiliary								
1	4 124 29	<p>Fitted on left-hand side of latching relay (equipped or not with control auxiliary) Maximum 2 auxiliaries per latching relay Used to signal the status of the contacts on the associated product</p> <p><b>Auxiliary changeover switch</b></p> <table border="1"> <tr> <th>I max.</th> <th>Voltage</th> <th>Contact</th> <th>Number of modules</th> </tr> <tr> <td>5 A</td> <td>250 V<math>\sim</math></td> <td>N/C + N/O</td> <td>0.5</td> </tr> </table>	I max.	Voltage	Contact	Number of modules	5 A	250 V $\sim$	N/C + N/O	0.5
I max.	Voltage	Contact	Number of modules							
5 A	250 V $\sim$	N/C + N/O	0.5							
1	4 124 33	<p><b>Control auxiliary</b></p> <p>Fitted on left-hand side of latching relay Maximum 1 control auxiliary per latching relay Compatible with signalling auxiliary Cat.No 4 124 29</p> <p><b>Auxiliary device for centralized control</b> For a centralized control of different latching relays from one single point</p> <table border="1"> <tr> <th>Number of modules</th> </tr> <tr> <td>0.5</td> </tr> </table>	Number of modules	0.5						
Number of modules										
0.5										
1	4 124 34	For latching relays 24 V $\sim$ to 48 V $\sim$								
1	4 124 36	For latching relays 230 V $\sim$								
1	4 124 36	<p><b>Auxiliary device for general centralized control</b> For simultaneous control of different groups of latching relays, already fitted with auxiliary device for centralised control 230 V<math>\sim</math> Cat.No 4 124 34</p> <table border="1"> <tr> <th>Number of modules</th> </tr> <tr> <td>1</td> </tr> </table>	Number of modules	1						
Number of modules										
1										
1	4 124 37	<p><b>Auxiliary device for maintained contact</b> Allows the control of a latching relay via one maintained contact (i.e. time switches)</p> <table border="1"> <tr> <th>Number of modules</th> </tr> <tr> <td>0.5</td> </tr> </table>	Number of modules	0.5						
Number of modules										
0.5										
1	4 124 39	<p><b>Compensator module</b></p> <p>Used to control 230 V<math>\sim</math> - 50 Hz pulse operated latching relays via illuminated push-buttons without malfunctions Connects to the terminals of the pulse operated latching relay coil Compensation: - 1 compensator module for a total consumption of 3 to 6 mA (example: 6 to 11 illuminated push-buttons consuming 0.55 mA each) - 2 compensators modules for a total consumption of 6 to 9 mA (example: 12 to 17 illuminated push-buttons with consuming 0.5 mA each)</p> <table border="1"> <tr> <th>Number of modules</th> </tr> <tr> <td>1</td> </tr> </table>	Number of modules	1						
Number of modules										
1										
1	4 124 39	<p>Impedance compensator for 230 V<math>\sim</math> pulse operated latching relays</p> <table border="1"> <tr> <th>Number of modules</th> </tr> <tr> <td>1</td> </tr> </table>	Number of modules	1						
Number of modules										
1										

# Pulse operated latching relays

## Wiring diagrams

### Signalling with auxiliary Cat.No 4 124 29

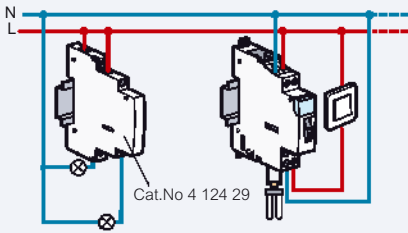

### Centralized control at one point using auxiliary devices Cat.Nos 4 124 34 and 4 124 36

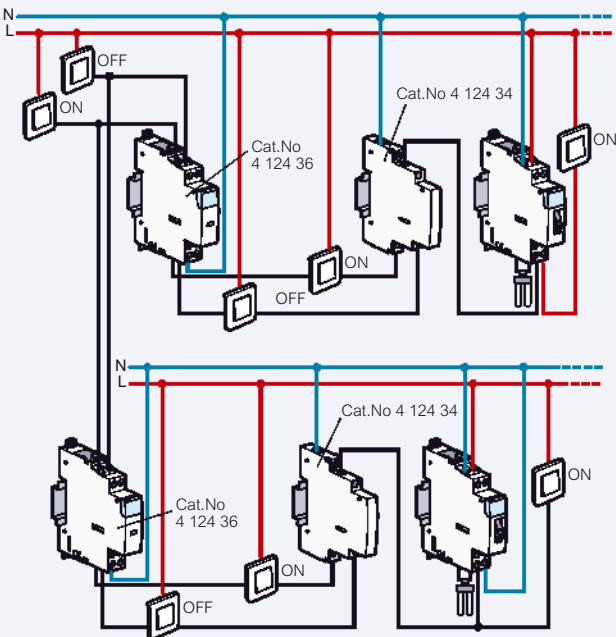

Use only non illuminated push-buttons

### Control via maintained contact using auxiliary device Cat.No 4 124 37 and time switch

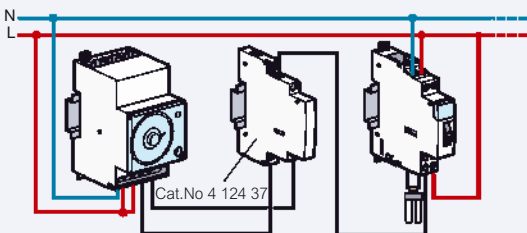

## Technical characteristics

### Power consumption

Cat.Nos	4 124 00 4 124 01	4 124 04	4 124 05 4 124 10	4 124 14	4 124 11	4 124 08 4 124 12	4 124 16
Control voltage	230 V~	12 V~	24 V~	24 V~	48 V~	230 V~	230 V~
Nominal current	16 A	16 A	16 A	16 A	16 A	16 A	16 A
Connection	1 N/O	1 N/O	1 N/O 2 N/O	4 N/O	2 N/O	1 N/O 2 N/O	4 N/O
Number of modules	1	1	1	1	1	1	2
Holding	-	670 mA	280 mA	570 mA	170 mA	30 mA	50 mA
Inrush	-	2500 mA	1200 mA	2500 mA	700 mA	130 mA	250 mA

### Connection cross section mm<sup>2</sup>

Type of conductors	Cross section
Rigid	1 x 6 mm <sup>2</sup> or 2 x 2.5 mm <sup>2</sup>
Flexible	1 x 6 mm <sup>2</sup> or 2 x 2.5 mm <sup>2</sup>
Flexible with single ferrule	6 mm <sup>2</sup>
Flexible with double ferrule	2 x 4 mm <sup>2</sup>

# Power contactors with handle CX<sup>3</sup>

from 16 A to 63 A



4 125 44

4 125 56

Dimensions **see e-catalogue**  
 Technical characteristics **p. 72**

Conform to IEC/EN 61095  
 Space for power supply busbar on top (up to 25 A)

Pack	Cat.Nos	Power contactors with 24 V~ coil and handle			
		Manual override for test and repair function, carried out via the handle Permanent "ON" or "OFF" without automatic reset			
		<b>2-pole - 250 V~</b>			
		I max	Connection	Type of contact	Number of modules
1	4 125 14	25 A		2 N/O	1
1	4 125 15 <sup>1</sup>	40 A		2 N/O	2
1	4 125 16 <sup>1</sup>	63 A		2 N/O	2
		<b>4-pole - 400 V~</b>			
1	4 125 17	25 A		4 N/O	2
1	4 125 18 <sup>1</sup>	40 A		4 N/O	3
1	4 125 19 <sup>1</sup>	63 A		4 N/O	3
		<b>Low noise power contactors with 230 V~ coil and handle</b>			
		<b>2-pole - 250 V~</b>			
		I max	Connection	Type of contact	Number of modules
1	4 125 58	25 A		2 N/O	1
1	4 125 59 <sup>1</sup>	40 A		2 N/O	2
1	4 125 60 <sup>1</sup>	63 A		2 N/O	2
		<b>4-pole - 400 V~</b>			
1	4 125 61	25 A		4 N/O	1
1	4 125 62 <sup>1</sup>	40 A		4 N/O	2
1	4 125 63 <sup>1</sup>	63 A		4 N/O	2

Pack	Cat.Nos	Power contactors with 230 V~ coil and handle			
		Manual override for test and repair function, carried out via the handle Permanent "ON" or "OFF" without automatic closing of the contactor			
		<b>2-pole - 250 V~</b>			
		I max	Connection	Type of contact	Number of modules
4	4 125 44	25 A		2 N/O	1
1	4 125 45 <sup>1</sup>	40 A		2 N/O	2
1	4 125 47 <sup>1</sup>	63 A		2 N/O	2
1	4 125 48 <sup>1</sup>	63 A		2 N/C	2
		<b>3-pole - 400 V~</b>			
1	4 125 49 <sup>1</sup>	40 A		3 N/O	3
1	4 125 50 <sup>1</sup>	63 A		3 N/O	3
		<b>4-pole - 400 V~</b>			
2	4 125 51	25 A		4 N/O	2
1	4 125 53 <sup>1</sup>	40 A		4 N/O	3
1	4 125 56 <sup>1</sup>	63 A		4 N/O	3
1	4 125 57 <sup>1</sup>	63 A		4 N/C	3

1: Handle can be accessed after removing blanking plate



# Power contactors without handle CX<sup>3</sup>

# Auxiliaries for contactors CX<sup>3</sup>

from 16 A to 63 A



4 125 05

4 125 35



4 124 29

4 124 31

Dimensions **see e-catalogue**  
 Technical characteristics **p. 72**

Conform to IEC/EN 61095  
 Space for power supply busbar on top (up to 25 A)

## Pack Cat.Nos Power contactors with 24 V~ coil

Pack	Cat.Nos	I max	Connection	Type of contact	Number of modules
1	4 125 03	16 A		N/C + N/O	1
1	4 125 05	25 A		2 N/O	1
1	4 125 10	25 A		4 N/O	2
1	4 125 09	25 A		2 N/C + 2 N/O	2

## Pack Cat.Nos Power contactors with 230 V~ coil

Pack	Cat.Nos	I max	Connection	Type of contact	Number of modules
4	4 125 21	16 A		N/C + N/O	1
10	4 125 23	25 A		2 N/O	1
1	4 125 27	63 A		2 N/O	2
1	4 125 24	25 A		2 N/C	1
5	4 125 35	25 A		4 N/O	2
1	4 125 41	63 A		4 N/O	3
1	4 125 36	25 A		4 N/C	2
1	4 125 33	25 A		2 N/C + 2 N/O	2

## Pack Cat.Nos Signalling auxiliaries for contactors

Auxiliary changeover switch for all CX<sup>3</sup> contactors  
 Used to signal the position status of the contacts on the product to which it is connected

Pack	Cat.Nos	I max	Voltage	Contact	Number of modules
1	4 124 29	5 A	250 V~	N/C + N/O	0.5
1	4 124 30	5 A	250 V~	N/C + N/O	0.5
1	4 124 31	5 A	250 V~	N/C + N/O	0.5

### For 1 module contactors 16 A to 25 A

Maximum 2 auxiliary devices per contactor  
 Fitted on left-hand side of contactor

### For 2 module contactors 25 A

Maximum 2 auxiliary devices per contactor  
 Fitted on left-hand side of contactor

### For 40 and 63 A contactors

Maximum 1 auxiliary device per contactor  
 Fitted on left-hand side of contactor

For detailed dimensions,  
**see e-catalogue**



## Technical characteristics

- Rated impulse withstand voltage (Uimp): 4 kV
- Mechanical endurance (no. of operating cycles): 10<sup>6</sup> cycles
- Operating temperatures: - 25 °C to + 40 °C
- Storage temperatures: - 40 °C to + 70 °C

### Contactor protection against short circuits according to standard EN 61095, conditional short-circuit current:

- I<sub>q</sub> = 6 kA for 16 to 25 A contactors
- I<sub>q</sub> = 3 kA for 40 to 63 A contactors

Circuit breaker or gG fuse rating:

- ≤ 16 A for 16 A rating      • ≤ 40 A for 40 A rating
- ≤ 25 A for 25 A rating      • ≤ 63 A for 63 A rating

### Consumption of a contactor control coil

16 A and 25 A power contactors					
Coil voltage	24 V~		230 V~ low noise	230 V~	
	Current	16 A and 25 A	25 A	25 A	16 A and 25 A
Type of contact	NC + NO 2 NO	4 NO	2 NO	NC + NO 2 NO 2 NC	2 NC + 2 NO 4 NO 4 NC
Dimensions	1 mod.	2 mod.	1 mod.	1 mod.	2 mod.
Holding current	200 mA	300 mA	12 mA	20 mA	20 mA
Inrush current	970 mA	2500 mA	60 mA	90 mA	200 mA

40 A and 63 A power contactors				
Coil voltage	24 V~		230 V~	
	Current	40 A and 63 A	40 A and 63 A	40 A and 63 A
Type of contact	2 NO	4 NO	2 NO 2 NC	3 NO 4 NO 4 NC
Dimensions	2 mod.	3 mod.	2 mod.	3 mod.
Holding current	250 mA	270 mA	15 mA	30 mA
Inrush current	1750 mA	1500 mA	150 mA	200 mA

### Recommendations

- Insert a spacing module (Cat.No 4 063 07 p. 61):
- every two contactors when the ambient temperature is below 40 °C
- every contactor when the ambient temperature is between 40 and 60 °C

Contactor rating	40 °C	50 °C	60 °C
I <sub>e</sub> = 16 A	16 A	14 A	12 A
I <sub>e</sub> = 25 A	25 A	22 A	20 A
I <sub>e</sub> = 40 A	40 A	36 A	32 A
I <sub>e</sub> = 63 A	63 A	57 A	50 A

### Max. connection cross-section in mm<sup>2</sup>

Conductor type	Ratings ≤ 25 A	Ratings 40 & 63 A
Rigid	6 <sup>2</sup> or 2 x 2.5 <sup>2</sup>	25 <sup>2</sup> or 2 x 10 <sup>2</sup>
Flexible	6 <sup>2</sup> or 2 x 2.5 <sup>2</sup>	25 <sup>2</sup> or 2 x 10 <sup>2</sup>
Flexible with single end cap	6 <sup>2</sup>	16 <sup>2</sup>
Flexible with double end cap	2 x 4 <sup>2</sup>	2 x 16 <sup>2</sup>

## Contactor selection charts

### Incandescent lamps

Tungsten and halogen filaments 230 V~								
Nominal wattage	40 W	60 W	75 W	100 W	150 W	200 W	500 W	1000 W
16 A	45	30	24	19	13	10	4	2
25 A	60	48	38	30	20	15	6	3
40 A	96	77	61	48	32	24	10	5
63 A	154	123	97	77	51	38	15	8

ELV halogen bulbs with ferromagnetic ballast						ELV halogen bulbs with electronic ballast						
Nominal wattage	20 W	35 W	50 W	75 W	100 W	150 W	20 W	35 W	50 W	75 W	100 W	150 W
16 A	32	20	15	12	9	6	60	40	28	18	14	9
25 A	52	30	24	16	12	8	80	50	40	26	20	13
40 A	68	39	31	21	16	10	112	70	56	36	28	18
63 A	88	51	41	27	20	14	157	98	78	51	39	25

## Contactor selection charts (continued)

### Fluorescent tubes with ferromagnetic ballast

Nominal wattage	Single parallel compensated fluorescent					Double series compensated fluorescent				
	18 W	20 W	36 W	58 W	115 W	2 x 20 W	2 x 36 W	2 x 40 W	2 x 58 W	2 x 140 W
16 A	24	24	16	11	5	30	24	22	15	6
25 A	33	30	25	17	9	45	38	35	24	10
40 A	43	39	33	22	12	68	57	53	36	15
63 A	56	51	42	29	15	101	86	79	54	23

Nominal wattage	Quadruple series compensated fluorescent		Compact fluorescent with built-in starter			
	4 x 18 W		7 W	10 W	18 W	26 W
16 A	16		50	40	28	19
25 A	24		60	50	42	28
40 A	36		78	65	55	36
63 A	54		101	85	71	47

### Fluorescent tubes with electronic ballast

Nominal wattage	Single fluorescent				Double fluorescent		
	18 W	30 W	36 W	58 W	2 x 18 W	2 x 36 W	2 x 58 W
16 A	72	42	36	22	36	20	12
25 A	110	68	58	36	56	30	19
40 A	165	102	87	54	84	45	29
63 A	248	153	131	81	126	68	43

Nominal wattage	Triple fluorescent (series compensated)		Quadruple fluorescent (series compensated)	
	3 x 14 W	3 x 18 W	4 x 14 W	4 x 18 W
16 A	34	26	26	20
25 A	46	38	37	28
40 A	62	51	52	39
63 A	84	69	73	55

Nominal wattage	Compact fluorescent with built-in electronic power supply				
	7 W	11 W	15 W	20 W	23 W
16 A	120	80	64	50	43
25 A	200	125	90	70	60
40 A	280	175	126	98	84
63 A	392	245	176	137	118

### Discharge lamps with compensation

Nominal wattage	Metal halogenide						Low pressure sodium vapour					
	35 W	70 W	100 W	150 W	250 W	400 W	18 W	35 W	55 W	90 W	135 W	180 W
16 A	10	6	5	3	2	1	12	6	5	3	2	2
25 A	15	9	7	5	3	2	20	10	7	5	3	3
40 A	23	14	11	8	5	3	30	15	11	8	5	5
63 A	34	20	16	11	7	5	45	23	16	11	7	7

Nominal wattage	High pressure sodium vapour					High pressure mercury vapour				
	70 W	150 W	250 W	400 W	1000 W	50 W	80 W	125 W	250 W	400 W
16 A	8	7	5	3	1	11	8	6	3	2
25 A	10	9	6	4	2	15	10	8	4	3
40 A	15	14	9	6	3	21	14	11	6	4
63 A	23	20	14	9	5	29	20	16	8	6

Nominal wattage	High pressure mixed			
	100 W	160 W	250 W	400 W
16 A	9	6	4	2
25 A	11	7	5	3
40 A	14	9	7	4
63 A	19	12	8	5

## Push-buttons, control switches and indicators

## Changeover switches

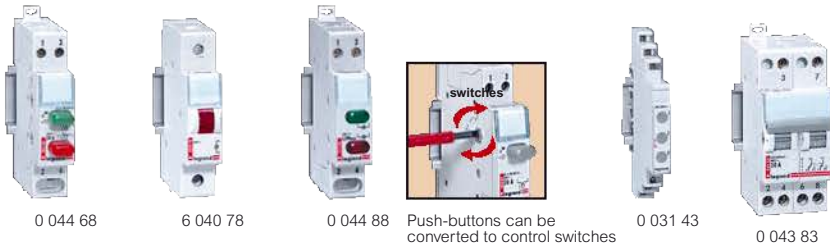

Technical characteristics [see e-catalogue](#)

Pack	Cat.Nos	<b>Push-buttons and control switches</b> 20 A - 250 V~	
		Compatible with prong-type supply busbars Conform to IEC 60669-1 Category of use AC 12 A according to IEC 60947-5-1 Supplied in push-button position Can be converted to control switches	
		<b>Single function</b>	
10	0 044 53	1 N/O	1
10	0 044 54	1 N/C	1
10	0 044 55	2 N/O	1
10	0 044 58	1 N/O + N/C	1
		<b>Dual functions</b>	
10	0 044 63 <sup>1</sup>	1 N/O + green indicator	1
10	0 044 64 <sup>1</sup>	1 N/C + red indicator	1
10	0 044 68	1 N/O (green) + 1 N/C (red)	1
		<b>Indicators</b>	
		<b>Single indicator</b>	
		Supplied with 230 V~ non replaceable LED lamps (100000 hours life time)	
12	6 040 77	Green	1
12	6 040 78	Red	1
12	6 040 79	Orange	1
		<b>Double indicator</b>	
		Supplied with diffuser and replaceable lamp E 10 - 230 V~	
10	0 044 88	Green + red	1
		<b>Three-phase voltage indicator</b>	
		Supplied with lamps 230/400 V~ non replaceable	
2	0 031 43	3 neon lamps colourless	0.5
		<b>Accessories</b>	
		<b>Replacement lamps E 10 - 1.2 W</b>	
10	0 044 33	24 V incandescent	
10	0 044 36	230 V neon	
10	0 044 37	230 V fluo for blue and green diffusers	

1: Supplied with E 10 lamps 230 V~

Technical characteristics [see e-catalogue](#)

Conform to standard IEC 60669-1  
Category of use AC 22 A according to IEC 60947-3

Pack	Cat.Nos	<b>Changeover switches</b>		
		<b>Two-way - 250 V~</b>		
10	0 043 82	Nominal rating (A) 20	Connection 	Number of modules 1
		<b>Double two-way - 400 V~</b>		
5	0 043 83	20		2
		<b>Two-way with centre point - 250 V~</b>		
10	0 043 85	20		1
		<b>Double two-way with centre point - 400 V~</b>		
5	0 043 86	20		2

# Programmable time switches

with digital display



Dimensions **see e-catalogue**

For switching an electric circuit (lighting, heating) ON or OFF at selected times during a pre-programmed time period  
Temporary (automatic return) or permanent (forced switching ON or OFF) override on output

Pack	Cat.Nos	Standard - daily or weekly programme with 6 years clock working reserve	Pack	Cat.Nos	2 outputs multiple functions annual programme - 5 years clock working reserve
1	0 037 05	<p>Compatible with alternative renewable energy systems such as photovoltaic panels Automatic summer/winter changeover Clock precision: <math>\pm 1</math> sec per day Minimum programme setting: 1 min 28 programmes</p> <p><b>Power supply 120/230 V<math>\sim</math> - 50/60 Hz</b> 1 output 16 A - 250 V<math>\sim</math> <math>\mu \cos \varphi = 1</math> per 1 inverter contact Low consumption: 0.1 W</p>	1	4 126 30	<p>Programme settings: on daily, weekly or yearly basis 15 languages A programme consists of a on and off time and their assignement to certain days Option to suspend the programme for a specific period to set-up with start and date Minimum programme setting: 1 s. High precision clock: <math>\pm 0.1</math> sec per day Programmed directly on keypad, or using program transfer key Cat.No 4 128 72</p> <p><b>Power supply 230 V<math>\sim</math> - 50/60 Hz</b> 2 outputs - 230 V<math>\sim</math> - 50/60 Hz Astronomical function 2 x 3 x 28 = 168 programmes</p>
1	4 126 31	<p><b>Multiple functions - daily or weekly programme - 5 years clock working reserve</b> Programme settings: on daily or weekly basis 15 languages A programme consists of a on and off time and their assignement to certain days Option to suspend the programme for a specific period to set-up with start and date Minimum programme setting: 1 s. High precision clock: <math>\pm 0.1</math> sec per day Particularly suited to irregular cycles: - security installations (access point, alarms, etc.), - industrial installations (pump stations, etc.) Programmed directly on keypad, or using program transfer key Cat.No 4 128 72 Additional functions including random (irregular cycles), hour counters</p> <p><b>Power supply 230 V<math>\sim</math> - 50/60 Hz</b> 1 output 16 A - 250 V<math>\sim</math> 56 programmes <math>\mu \cos \varphi = 1</math> per 1 inverter contact</p> <p><b>Power supply 24 V<math>\sim</math> - 50/60 Hz and =</b> 1 output 16 A - 24 V<math>\sim</math> 56 programmes <math>\mu \cos \varphi = 1</math> per 1 inverter contact</p>	2	0 047 70	<p><b>4 outputs multiple functions annual programme - 5 years clock working reserve</b> 15 languages High precision clock: <math>\pm 0.2</math> sec per day For programming periods throughout the year 28 programmes per channel possible: - daily - weekly / astronomical programmes - yearly programmes - exceptional programmes Manual override (switch on and off) for every channel on the front of the switch Programmed directly on keypad, or using programme transfer key supplied</p> <p><b>Annual programme</b> 4 outputs - 120/230 V<math>\sim</math> - 50/60 Hz Astronomical function</p> <p><b>Battery</b> Working reserve 5 years for Cat.No 0 047 70</p> <p><b>Programming transfer key</b> Can be used to store programme settings made: - Directly on a multifunction and multi-programme time switch Cat.Nos 4 126 30/31/32/33/41/54/57 (loading on device) - with the programming software installed on a PC running Windows (loading on data loader)</p> <p><b>Programming software</b> Can be used to create, save and transfer program settings for multifunction and multi-program time switches, Cat.Nos 0 047 70, 4 126 30/31/32/33/41/54/57 Data is transferred to the program transfer key Cat.No 4 128 72, using the data loader connected to the USB port of the PC Kit comprising software on CD-ROM, data loader and transfer key Windows XP, Windows 7, Windows 8 compatible</p>
1	4 126 41		2	0 047 82	
1	4 126 54		2	4 128 72	
1	4 126 57		2	4 128 73	
1	4 126 32		2		
1	4 126 33		2		

# Programmable time switches

with analogue dial



# Programmable time switches

with analogue and digital dial



4 127 90

4 127 95

Dimensions [see e-catalogue](#)

Programmed via captive segment  
 Power supply: 230 V $\sim$  - 50/60 Hz  
 3-position override switch "ON-AUTO-OFF" on front panel  
 Manual changeover to summer/winter time  
 1 outlet 16 A - 250 V $\sim$  -  $\mu$  cos  $\varphi$  = 1

Pack	Cat.Nos	Daily programme	Number of modules
1	4 127 80	1 segment = 15 minutes Accuracy: $\pm$ 5 minutes <b>Vertical dial</b> Minimum switching time: 15 minutes N/O contact Without working reserve	1
1	4 127 90	With 100 h working reserve	1
1	4 128 12	<b>Horizontal dial</b> Minimum switching time: 15 minutes Changeover switch Without working reserve	3
1	4 128 13	With 100 h working reserve	3
<b>Weekly programme</b>			
1	4 127 94	1 segment = 2 hours Accuracy: $\pm$ 30 minutes <b>Vertical dial</b> Minimum switching time: 2 hours N/O contact With 100 h working reserve	1
1	4 127 95	<b>Horizontal dial</b> Minimum switching time: 4 hours Changeover switch With 100 h working reserve	3

## Diagrams

Cat.Nos 4 127 80/90/94

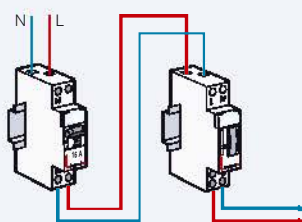

Cat.Nos 4 128 12/13, 4 127 95

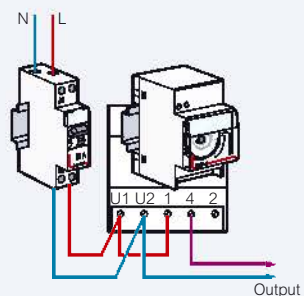

Cat.No 0 047 70

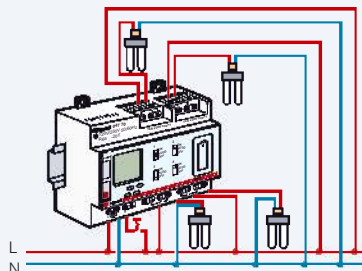

Cat.Nos 4 126 31/32/33

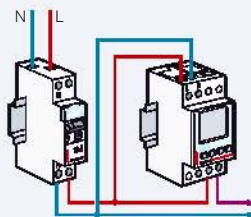

Cat.No 4 126 54

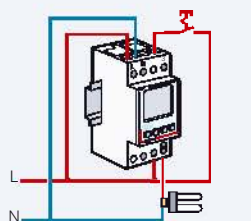

Cat.No 4 126 57

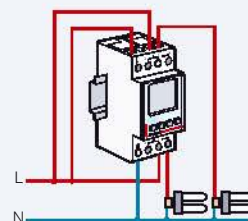

Output closing and breaking times are calculated based on the date, the actual time when the device was switched and on geographical coordinates of the actual location

## Technical characteristics

Cat.Nos	Prog. time	Min. programme settings	Working reserve	Summer/winter time	Outputs 16 A	Nb of prog.	Nb of modules
0 037 05	7 d	1 min	5 years	auto	1	28	1
0 047 70	24 h/7 d/1 y	1 s	5 years	auto	4	4 x 3 x 28	6
4 126 30	1 year	1 s	5 years	auto	2	2 x 3 x 28	2
4 126 31	24 h/7 d	1 s	5 years	auto	1	56	2
4 126 32	24 h/7 d	1 s	5 years	auto	1	56	2
4 126 33	24 h/7 d	1 s	5 years	auto	1	56	2
4 126 41	24 h/7 d	1 s	5 years	auto	2	2 x 28	2
4 126 54	24 h/7 d	1 s	5 years	auto	1	56	2
4 126 57	24 h/7 d	1 s	5 years	auto	2	2 x 28	2

Cat.Nos	Programme	Segment	Min. switching time	Working reserve	16 A output via contact		Nb of modules
					N/O	Chang. S.	
4 128 12	24 h	15 min	30 min	without	-	1	3
4 128 13	24 h	15 min	30 min	100 h	-	1	3
4 127 80	24 h	15 min	15 min	without	1	-	1
4 127 90	24 h	15 min	15 min	100 h	1	-	1
4 127 94	7 d	2 h	2 h	100 h	1	-	1
4 127 95	7 d	2 h	4 h	100 h	-	1	3



Power supply 230 V $\sim$   
 Override switching "ON" or "OFF" in front face  
 1 output via changeover contact  
 (2 changeover contacts for Cat.No 0 499 26)

Pack	Cat.Nos	Daily programme
1	6 499 14	<b>20 A - 250 V<math>\sim</math> - <math>\mu</math> cos <math>\varphi</math> = 1</b> Shortest switching time: 30 minutes (1 segment = 10 minutes) Switching accuracy: + 5 minutes
1	0 497 56	<b>Weekly programme</b> <b>16 A - 250 V<math>\sim</math> - <math>\mu</math> cos <math>\varphi</math> = 1</b> Shortest switching time: 3 hours (1 segment = 1 hour) Switching accuracy: + 20 minutes Working reserve: 500 h with quartz controlled motor
1	0 044 09	Adaptor for fixing time switch on rail EN 50022
1	0 499 26	<b>Defrosting time switch</b> Time switch for short periods for control of defrosting, regularly repeated switching of pumps, feed conveyors, sprinkler systems, periodic lubrication of machines 16 A - 250 V $\sim$ $\mu$ cos $\varphi$ = 1 IP 30 Daily programme The timer can repeat one or two settable short programmes within 24 hours Shortest switching sequence 2.5 hours - up to 9 times 1 switching step = 1 segment = 30 min. 50 Hz Defrosting time from 1 to 60 minutes per contact
1	6 998 11	<b>OmniRex - Plug-in time switches</b> Manuel switch ON - Auto With 2P+ $\neq$ plug and 10/16 A socket base and 16 A socket With child protection Override/manual switch Mains hold accuracy Synchronous motor, 230 V, 50 Hz 1 contact NO 250 V/50 Hz, 16 A $\sim$ cos $\varphi$ = 1
1	6 998 12	<b>OmniRex T - 24-hour programme</b> German standard - With child protection Switching step 15 min Mini switching time 15 min Switching accuracy $\pm$ 5 min
1	6 998 12	<b>OmniRex W - 7-day programme</b> German standard - With child protection Switching step 2 hours Mini switching time 2 hours Switching accuracy $\pm$ 30 min

Conform to EN 60730-1 and EN 60730-2-7

Digital daily weekly DIN rail mounting time switches  
 A programme consists of a ON and OFF time and their assignment to certain days of the week (or a combination of days) and a selected channel (for the 2-channel version).

- Additional features:
- manual override (permanent ON or OFF)
  - automatic override (ON/OFF): actual program will be inversed (ON->OFF, OFF->ON) till next programmed ON time
  - working reserve : 3 years
  - replaceable battery

Pack	Cat.Nos	MicroRex D21 Plus
1	6 037 70	<b>1 channel 230 V<math>\sim</math> , 50/60 Hz</b> Language English
1	6 037 78	French
1	6 037 72	Spanish

Pack	Cat.Nos	MicroRex D22 Plus
1	6 037 71	<b>2 channels 230 V<math>\sim</math> , 50/60 Hz</b> Language English
1	6 037 79	French
1	6 037 73	Spanish

# Electronic time-lag switches



# Electronic time-lag switches



Dimensions **see e-catalogue**

Designed for supply busbar compatibility  
 Power supply: 230 V~ - 50/60 Hz  
 Switches a lighting circuit for a specific time  
 Self-protection in the event of blocked pushbutton

Pack	Cat.Nos	Time-lag switch	Number of modules
10	4 126 02	<b>Resettable</b> 230 V~ - 50/60 Hz Timing adjustable from 0.5 sec to 10 min Manual override contact Output 16 A - 250 V~ - $\mu \cos \varphi = 1$ 2000 W incandescent/halogen 2000 W halogen - 230 V~ 1000 VA fluo - series compensated 120 VA fluo - parallel compensated 14 $\mu\text{F}$ 100 VA compact fluorescent 1000 W energy saving lamp automatic 3-wire or 4-wire connection	1
10	0 047 04	<b>Multi-function time-lag switch</b> Resettable 230 V~ - 50/60 Hz Timing adjustable from 0.5 sec to 12 min Operation with 3 or 4 wires a utomatically recognised by the time-lag switch - Inputs for separate control 8-230 V (presence detection, lighting control by door entry system etc.) - Switch-off pre-warning function, - Long duration function (1 hour) and manual switch-off Output 16 A - 250 V~ - $\mu \cos \varphi = 1$ 3680 W incandescent/halogen 2000 W halogen 230 VA 1000 VA fluo - parallel compensated $\leq 100 \mu\text{F}$ 2000 VA compact fluorescent 500 W halogen lamp + ferromagnetic transformer 2000 W halogen lamp + electronic transformer - Specially suited to energy saving lamps 1000 W	1
1	0 497 83	<b>Automatic staircase time-lag switch for wall mounting 230 V - 50 Hz</b> Switches a lighting circuit during a determined period Controlled by illuminated push-button 50 mA max 3 wire connection Output : 1 contact Contact rating 10 A - 250 V~ - $\cos \varphi = 1$ Type of delay adjustable Electronic 0.5 to 10 min.	Type Resettable

## Multi-function time-lag switch

### 4-wire

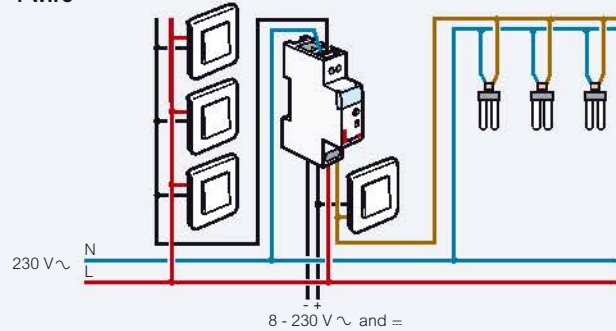

### 3-wire

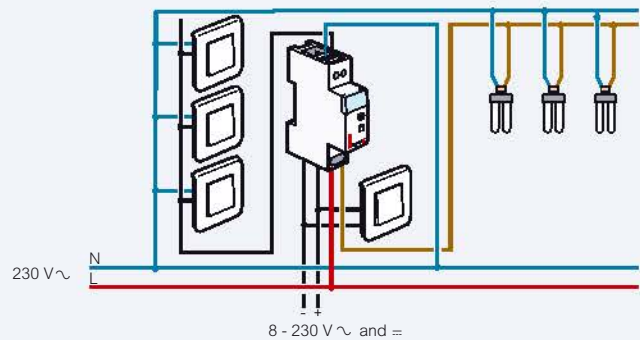

### Multi-function time-lag switch: lighting control by door entry system

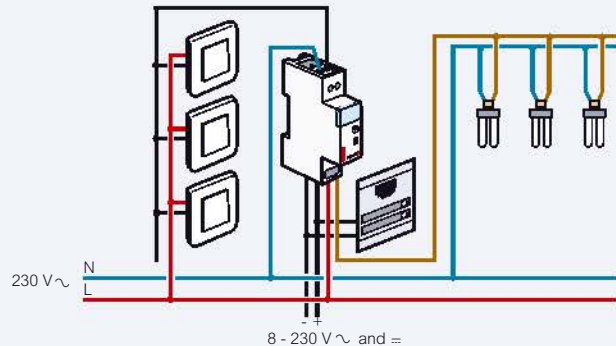

### Switch-off pre-warning function

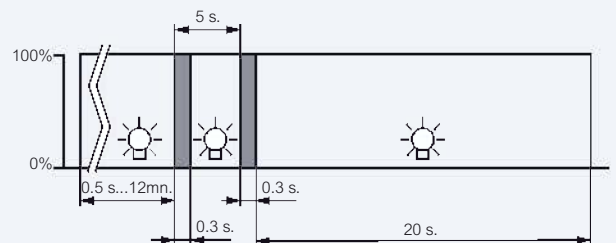

For fluorescent and energy saving lamps the switch-off period is longer than 0.3 s, because of re-starting time required by the lamps



4 126 23

4 126 26

4 128 58

Dimensions **see e-catalogue**

Can be used to switch a lighting circuit "ON" and "OFF" based on light conditions (nightfall, daybreak)  
 Supplied with IP 65 weatherproof photoelectric cell  
 Power supply: 230 V~ - 50/60 Hz

Pack	Cat.Nos	Standard
1	4 126 23	Output 16 A - 250 V~ - $\mu \cos \varphi = 1$ 2000 W incandescent 2000 W series compensated fluorescent 1000 W parallel compensated fluorescent 70 $\mu$ F 1000 W energy-saving bulb 2000 W halogen bulb + ferromagnetic transformer 2000 W halogen bulb + electronic transformer Automatic timer response Adjustable from 1 to 100 000 lux Number of modules: 1 Supplied with IP 65 photoelectric cell Cat.No 4 128 58
1	4 126 26	<b>Programmable</b> 56 programmes possible : daily, weekly or yearly programmes Output 16 A - 250 V~ - $\mu \cos \varphi = 1$ 2000 W incandescent 2000 VA series compensated fluorescent 1000 W energy-saving bulb Integrated hour counter High precision clock : $\pm 0.1$ sec per day at 25°C Working reserve : 5 years Adjustable from 3 to 100 000 lux Automatic changeover between summer/winter time Number of modules: 2 Programmed directly on keypad, or using programme transfer key Cat.No 4 128 72 (p. 74) Supplied with IP 65 photoelectric cell Cat.No 4 128 58
1	4 128 58	<b>Replacement IP 65 photoelectric cell</b> IP 65 - IK 07 For use with standard or programmable light sensitive switches Cat.Nos 4 126 23/26



0 036 59

0 036 58

0 036 60

Pack	Cat.Nos	Remote control dimmers 100 - 240 V~ - 50/60 Hz	Number of modules
<b>Controlled via non-illuminated push-buttons</b>			
DIN rail mounting The last lighting level is stored into memory, in case of power cut or switch-off Direct or remote control (switching and dimming) with non-illuminated push-buttons			
1	0 036 59	For incandescent and halogen lamps 230 V~ and ELV halogen lamps with ferromagnetic transformers Load: 60 to 600 W (for 230 V~ 50/60 Hz)	2
1	0 036 58	For fluorescent lamps with 1-10 V dimmable ballast (fluorescent tubes and compact fluorescent lamps with separated dimmable ballast) Ballast power: maximum 800 VA (for 230 V~ 50/60 Hz) Control current: 50 mA	2
<b>Controlled via BUS line</b>			
DIN rail mounting Direct or remote control (switching and dimming) with non-illuminated double push-buttons or bus peripherals (Mosaic Programme and Céliane Programme) Equipped with illuminated scale indicating the light level of controlled lamps			
1	0 036 71	For incandescent and halogen lamps 230 V~, ELV halogen lamps with ferromagnetic or electronic transformers Load: 1000 W (for 230 V~ 50/60 Hz)	6
1	0 036 60	For fluorescent lamps with 1-10 V ballast (fluorescent tubes and compact fluorescent lamps with separated ballast) Ballast power: maximum 1000 VA (for 230 V~ 50/60 Hz) Control current: 50 mA	4
<b>Power supply for BUS line</b>			
1	0 036 80	BUS power supply for remote controlled dimmers Cat.Nos 036 60/71 For maximum 8 peripherals	2



# Time delay relays

12 to 230 VA and =

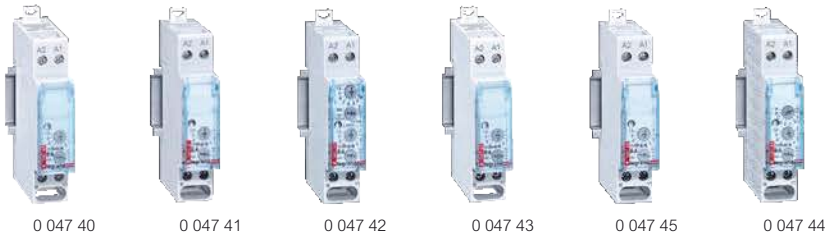

Dimensions **see e-catalogue**

For controlling the switching ON or OFF of a circuit (lighting, ventilation, automation, signalling) in operation for a specific time from 0.1 sec to 100 hrs  
 Supply voltage: 12 to 230 V $\sim$  (50/60 Hz) and =  
 Output: 8 A - 250 V $\sim$  -  $\mu$  cos  $\varphi$  = 1 per inverter contact

Pack	Cat.Nos	Time delay relays	Number of modules	Pack	Cat.Nos	Time delay relays (continued)	Number of modules
1	0 047 40	<b>ON delay</b> Delays load switch-on (alarm, lighting, contactor)  The time period starts when the relay is switched ON. At the end of the time period (T), the load is switched ON	1	1	0 047 43	<b>Timer (pulse)</b> For switching a load ON for a specific time (contactor)  The time period (T) starts with the closing of the non-illuminated switch or pushbutton. At the end of the time period, the load is switched OFF	1
1	0 047 41	<b>OFF delay</b> Delays load switch-off (ventilation, etc.)  The time period (T) starts with the opening of the non-illuminated switch or pushbutton. At the end of the time period, the load is switched OFF	1	1	0 047 45	<b>Wipe contact flick contactor</b> For switching a load ON for a specific time  The time period (T) starts when the relay is switched ON. At the end of the time period (T), the load is switched OFF	1
1	0 047 42	<b>Flashing</b> For switching ON and OFF a load (lighting, sounder) for different times and cyclically 	1	1	0 047 44	<b>Multifunction</b> <ul style="list-style-type: none"> <li>• ON delay</li> <li>• OFF delay</li> <li>• ON/OFF delay</li> <li>• Timer (pulse)</li> <li>• Timer and passing contact</li> <li>• Flashing</li> <li>• Totalizer on delay</li> <li>• Totalizer delay on power-up</li> </ul>	1

For detailed dimensions, **see e-catalogue**





4 130 91



4 130 98



0 041 07



0 042 80



0 042 85

Dimensions **see e-catalogue**

Pack	Cat.Nos	<b>Bell transformers</b>						
		<p> Conform to IEC / EN 61558-2-8 Protected against overloads and short circuits. In the event of an overload, switch "OFF" the power supply and allow the transformer to cool down before switching on again With label holders Wall or rail  mounting (for 4 modules) Possibility for supply busbars to run through (Cat.No 4 130 91)</p>						
		<b>230 V/12 V - 8 V</b>						
		Secondary (V)	Rating (A)	Power (VA)	Number of modules			
1	4 130 91	12/8	0.66/1	8	2			
1	4 130 92	12/8	2/3	24	4			
		<b>230 V/24 V - 12 V</b>						
1	4 130 93	24/12	1/1.5	24 - 18	4			
		<b>Safety transformers</b>						
		<p> Conform to IEC / EN 61558-2-6 Protected against overloads and short circuits. In the event of an overload, switch "OFF" the power supply and allow the transformer to cool down before switching on again Wall or rail  mounting (for 4 modules)</p>						
		<b>230 V/12 or 24 V</b>						
		(per coupling 2 x 12 V for Cat.No 4 130 98) Supplied with strip						
		P (VA)	No-load loss (W)	Voltage drop Cos φ = 1	Efficiency % Cos φ = 1	Ucc (%)	I (A) primary loaded	Number of modules
1	4 130 96	25	2.5	29	66	23.3	0.142	4
1	4 130 98	63	4	15.7	75	13.6	0.33	5
		<b>Buzzers and bells</b>						
		50 Hz AC - Connection by screw terminals, with label holder Allow insertion of supply busbars Caution: remove lamps from illuminated push-buttons when used with Cat.Nos 0 041 01						
		<b>Bells</b>						
		Voltage (V~)	Power (VA)	Consum. (mA)	Acoustic power*(dB)	Number of modules		
10	0 041 01	8/12	4/5	360/420	80/84	1		
10	0 041 07	230	6	27	83	1		
		<b>Buzzers</b>						
10	0 041 13	230	6	27	73	1		

1: Acoustic power at 1 m

0 044 05  
Equipment model:  
auxiliary control0 044 06  
Equipment model:  
bulbs, switch0 802 99  
Equipped with RJ45  
socket

Dimensions **see e-catalogue**

Allow insertion of supply busbars

Pack	Cat.Nos	<b>10-16 A - 250 V~</b>		Number of modules
10	0 042 80	<b>French standard</b> 2P + $\perp$ shuttered		2.5
10	0 042 85	<b>German standard</b> 2P + $\perp$ shuttered		2.5
		<b>20 A - 400 V~</b>		
5	0 042 91	<b>French standard</b> 3P + $\perp$ shuttered		3.5
5	0 042 92	3P + N + $\perp$ shuttered		3.5
		<b>Special supports</b>		
10	0 044 05	Pre-drilled support For mounting Ø22.5 mm control and signalling units		3
10	0 044 06	Support or blanking cover For other equipment (ex. switch, bulbs, printed-circuits...)		3
10	0 802 99	For mounting Mosaic 2-module mechanisms Support width 46.3 mm 2.5 modules		
		<b>Wiring management accessories</b>		
10	4 063 07	<b>Spacing unit with feedthrough</b> 0.5 module Allows cables to run between two modular devices and creates an air channel in order to limit temperature rise		

## Single phase power supplies



4 131 05



0 047 93

Dimensions [see e-catalogue](#)

For supplying PLCs and their peripherals or any use requiring a voltage of 5 V, 12 V, 15 V or 24 V<sub>DC</sub>  
Fixing on rail

Pack	Cat.Nos	Filtered rectified power supplies		
		Conform to standards IEC EN 61558-2-6 For equipment conforming to standards EN 61131-2, EN 60204 and EN 61439-1 Comprising: - A safety transformer with interference filtration - A filter capacitor - Protection by PTC integrated in the primary - Double operating terminals Terminal capacity: 6 mm <sup>2</sup> flexible Class II after addition of faceplate Ripple factor < 3% Ambient temperature without derating: 60 °C Power supply 230 V ± 15 V <sub>AC</sub>		
		<b>12 V<sub>DC</sub></b>		
		Power (W)	Current (A)	Number of modules
1	4 131 05	15	1.3	5
		<b>15 V<sub>DC</sub></b>		
1	4 131 06	15	1	5
		<b>24 V<sub>DC</sub></b>		
1	4 131 07	12	0.5	5
1	4 131 08	21.5	0.9	5

Pack	Cat.Nos	Stabilised power supplies		
		Conform to standards NF EN 61204, NF EN 60950 (Low Voltage Directive), EN 55022 (class B), EN 61000-4-2, EN 61000-3-26, ENV 50204 Switching mode Galvanic isolation 4000 V (input/output) With: - Electronic protection (overloads and short-circuits) - Integral fuse protection on input - A green voltage present indicator on output Power supply 115 - 230 V <sub>AC</sub>		
		<b>5 V<sub>DC</sub></b>		
		Power (W)	Current (A)	Number of modules
1	0 047 91	12.5	2.5	6
		<b>12 V<sub>DC</sub></b>		
1	0 047 92	30	2.5	6
		<b>24 V<sub>DC</sub></b>		
1	0 047 93	24	1	4

Pack	Cat.Nos	Power supplies with battery back-up		
		Conform to standards IEC/EN 61558-2-6, EN 55022 (class B), EN 61000-4-2 With "ON"/"OFF" button, operation indicator, fuse protection Power supply 230 V <sub>AC</sub>		
		<b>12 V<sub>DC</sub></b>		
		Capacity 280 mA/h		
		Power (W)	Current (A)	Number of modules
1	0 042 10	6	0.5	6

## Single phase power supplies

### Filtered rectified power supplies

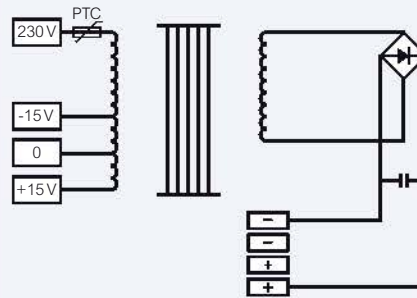

Cat.Nos	Voltage (V)	Current (A)	Weight (Kg)	I Prim. on load (A) at 230 V
4 131 05	12	1.3	0.95	0.15
4 131 06	15	1	0.95	0.15
4 131 07	24	0.5	0.95	0.13
4 131 08	24	0.9	0.95	0.17

Cat.Nos	Voltage of use				No load losses (W)	Total losses at 100% load (W)	Voltage drop cos φ = 1
	A no load (V)	On load (V)	With 100 kA load and prim. voltage + 10%	With nominal load and prim. voltage - 15%			
4 131 05	15.1	11.8	16.3	10.4	3.4	8.7	28.5
4 131 06	18.5	14.6	19.9	12.9	3.4	8.9	26.7
4 131 07	28.9	23.6	30.6	20.7	3.4	7.1	22.3
4 131 08	29.9	22.8	32.0	20.3	3.4	10.4	31.0

### Stabilised power supplies

Cat.Nos	Secondary		Primary			Max. out current (A)	Power consumption at max. temp. (W)	Efficiency
	Voltage (V)	Current (A)	Voltage (V)	Current consump. max. (A)	Inrush current max. (A)			
0 047 91	5	2.5	109-264	0.15/0.35	16	2.5	12.5	58
0 047 92	12	2.5	109-264	0.3/0.55	11	2.5	30	
0 047 93	24	1	109-264	0.25/0.45	13	1	24	73

Cat.Nos	Starting time on energisation (s) 230 V/115 V	Hold time (at 230 V) (ms)	Operating temperature	Residual ripple peak to peak (mVpp)	Line protection		Dim.	Max. weight	Max. operating temperature with derating (°C)
					With fuse (A)	With MCB (A) + type			
0 047 91	2.4/0.8	90	-10/+50	35	1A aM	2A/C	6 modules	0.32	50
0 047 92	10/3.7	115	-10/+50	20	1A aM	2A/C	6 modules	0.32	50
0 047 93	2.6/1	124	-10/+50	80	2A aM	6A/C	4 modules	0.25	50

### PTC protection

PTC: Positive temperature coefficient (limitation of overloads and temperature). In the event of an overload switch "off" the power supply and allow the power supplies to cool down before switching on again

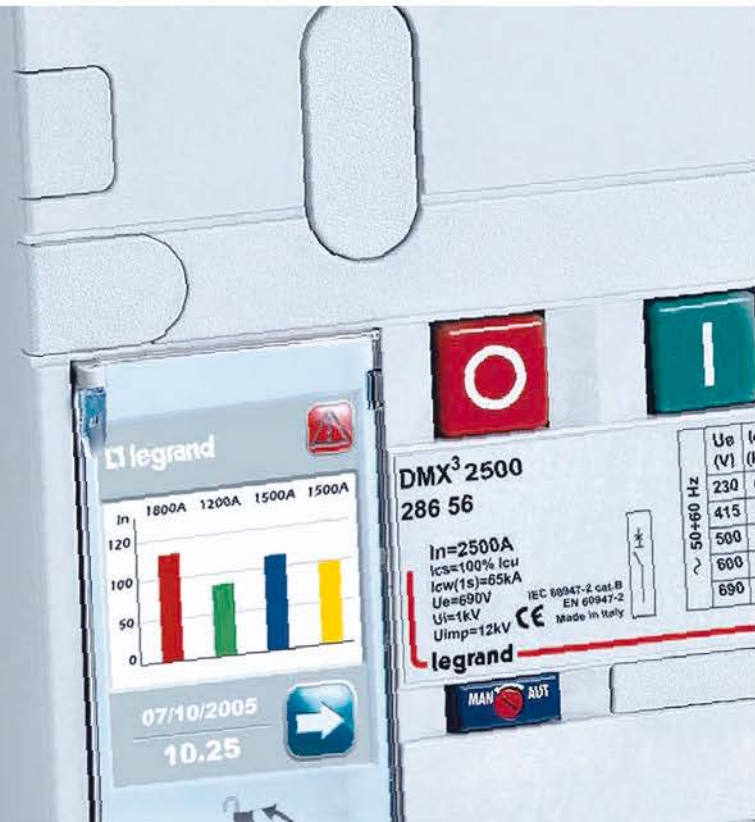

# ACBs, MCCBs, HEAD EQUIPMENT & ENERGY COMPENSATION

## Energy measurement



**P. 84**  
EMDX³ electrical energy meters  
└ rail mounting

## Reactive energy compensation



**NEW**  
**P. 94**  
Alpican capacitors



**P. 106**  
DRX 125 thermal magnetic MCCBs ≤ 125 A



**NEW**  
**P. 123**  
DPX³ 250 electronic release MCCBs ≤ 250 A



**NEW**  
**P. 134**  
DPX³ 1600 thermal magnetic MCCBs ≤ 1250 A

## Head equipment



**P. 140**  
DMX³ 2500/4000 ACBs ≤ 4000 A



**P. 147**  
DPX-IS isolating switches ≤ 1600 A



**P. 159**  
HRC cartridge fuses

## Supply busbars, distribution blocks & copper busbars



**P. 179**  
Supply busbars

## NEW PRODUCTS 2014



**DRX 630**  
thermal magnetic MCCBs up to 630 A  
(p. 114)



**DPX³**  
MCCBs up to 1600 A  
(p. 120)



**P. 84**  
EMDX<sup>3</sup> multi-function measuring units  
└ rail mounting



**P. 85**  
EMDX<sup>3</sup> multi-function measuring units on door



**P. 92**  
Ammeters & voltmeters  
└ rail mounting



**P. 93**  
Ammeters & voltmeters on door



**P. 96**  
Alpivar capacitors



**P. 97**  
Alpibloc fixed capacitor banks



**P. 100**  
Alpimatic automatic capacitor banks



**P. 103**  
Alptec power factor controllers



**P. 110**  
DRX 250 thermal magnetic MCCBs ≤ 250 A



**NEW P. 114**  
DRX 630 thermal magnetic MCCBs ≤ 630 A



**NEW P. 120**  
DPX<sup>3</sup> 160 thermal magnetic MCCBs ≤ 160 A



**NEW P. 122**  
DPX<sup>3</sup> 250 thermal magnetic MCCBs ≤ 250 A



**NEW P. 126**  
Auxiliaries & accessories for DPX<sup>3</sup> 160/250



**NEW P. 128**  
DPX<sup>3</sup> 630 thermal magnetic MCCBs ≤ 630 A



**NEW P. 129**  
DPX<sup>3</sup> 630 electronic release MCCBs ≤ 630 A



**P. 132**  
DPX<sup>3</sup> 630 earth leakage modules



**P. 134**  
DPX<sup>3</sup> 1600 electronic release MCCBs ≤ 1600 A



**P. 138**  
Auxiliaries & accessories for DPX<sup>3</sup> 630/1600



**P. 138**  
Supervision system



**P. 139**  
Residual current relays and coils



**P. 141**  
DMX<sup>3</sup> 6300 ACBs ≤ 4000 A



**P. 142**  
DMX<sup>3</sup> - I trip free switches ≤ 6300 A



**P. 143**  
Auxiliaries & accessories for DMX<sup>3</sup>



**NEW P. 146**  
Vistop isolating switches ≤ 160 A



**NEW P. 151**  
DPX<sup>3</sup>-I trip free switches ≤ 1600 A



**NEW P. 152**  
DCX-M changeover switches ≤ 1600 A



**P. 156**  
Proximity switches



**P. 158**  
SP fuse carriers



**P. 160**  
Blade type cartridge fuses



**NEW P. 164**  
MPX<sup>3</sup> MPCBs 0.16 A ≤ 22 A



**NEW P. 170**  
CTX<sup>3</sup> industrial contactors 9 A ≤ 800 A



**NEW P. 172**  
RTX<sup>3</sup> thermal relays



**P. 180**  
Modular distribution blocks ≤ 250 A



**P. 182**  
Power distribution blocks ≤ 400 A



**P. 185**  
Flat copper busbars & accessories



**P. 187**  
Isolating supports for busbars ≤ 6300 A



**DCX-M**  
changeover switches up to 1600 A  
(p. 152)

## EMDX<sup>3</sup> electrical energy meters

┌ rail mounting



Technical characteristics p. 89

Measure the electricity consumed by a single-phase or three-phase circuit downstream of the electricity distribution metering. Display electricity consumption in kWh, as well as other values such as current, active energy, reactive energy and power (depending on the catalogue number). Conform to standards IEC 62053-21/23, IEC 62052-11 and IEC 61010-1. MID compliance ensures accuracy of the metering with a view to recharging for the electricity used.

Pack	Cat.Nos		Single-phase meters
1	Non-MID 0 046 70	MID compliant	<b>Direct connection</b> 32 A - 1 module Pulse output
1	0 046 81		36 A - 2 modules Pulse output
1	0 046 72	0 046 78	63 A - 2 modules Pulse output
1	0 046 77	0 046 79	63 A - 2 modules RS 485 output
<b>Three-phase meters</b>			
1	Non-MID 0 046 73	MID compliant 0 046 82	<b>Direct connection</b> 63 A - 4 modules Pulse output
1	0 046 80	0 046 83	63 A - 4 modules RS 485 output
<b>Connection with CT</b>			
1	0 046 74	0 046 85	5 A - 4 modules pulse output
1	0 046 84	0 046 86	5 A - 4 modules RS 485 and pulse output
1	0 046 87		<b>Pulse concentrator</b> For collecting and transmitting measurements taken by 7 universal pulse electricity meters. Also collects data from other meters (gas meters, water meters, etc.) RS485 output 4 modules
1	4 120 00		<b>Measurement concentrator</b> Full or partial electricity metering for 5 uses: heating, cooling, domestic hot water, and power sockets + "other" 5 inputs for current transformers (up to 2 current transformers per input) 2 pulse inputs for water and gas metering LCD screen and 6-button keypad RJ45 IP output Power supply 110/230 VAC - 50/60 Hz 6 modules
1	4 120 02		<b>Split core current transformer</b> 90 A max. for the measurement concentrator Cat.No 4 120 00 Accepts : 10 x 1.5 mm <sup>2</sup> cables, or 7 x 2.5 mm <sup>2</sup> cables, or 2 x 6 mm <sup>2</sup> cables, or 1 x 10 or 16 mm <sup>2</sup> cable

## EMDX<sup>3</sup> multi-function measuring units

┌ rail mounting



Technical characteristics p. 90

Conform to standards:  
- IEC 61557-12  
- IEC 62053-22 class 0.5 S  
- IEC 62053-23 class 2

Pack	Cat.Nos	EMDX <sup>3</sup> modular
		For mounting on ┌ rail Width: 4 modules • LCD display • Measurement of currents, voltages, active, reactive and apparent power and internal temperature • Dual tariff metering: - Active energy consumed - Reactive energy consumed - Operating time - Power factor • THD voltages and currents up to order 51 • Programmable alarms on all functions • Outputs for controlling wiring devices, alarm feedback and pulse feedback
1	0 046 75	<b>EMDX<sup>3</sup> pulse unit</b> Data transmission via pulses
1	0 046 76	<b>EMDX<sup>3</sup> RS 485 unit</b> Data transmission via RS 485 communication interface and pulses

# EMDX<sup>3</sup> multi-function measuring units

for mounting on door or solid faceplate



0 146 68



0 146 69



0 146 73

Technical characteristics p. 90

Conform to standards:

- IEC 61557-12
- IEC 62053-22 class 0.5 S
- IEC 62053-23 class 2

Pack	Cat.Nos	EMDX <sup>3</sup> - Access	Pack	Cat.Nos	EMDX <sup>3</sup> - Premium (continued)
1	0 146 68	<b>Multi-function measuring unit</b> For mounting on door or solid faceplate Dimensions: 96 x 96 x 60 mm • LCD display • Measurement of currents, voltages, active, reactive and apparent power, internal temperature and power factor • Metering: - Active energy consumed or produced - Reactive energy consumed or produced - Operating time - Pulses • THD voltages and currents up to order 51 • Programmable alarms on all functions Can take 2 optional modules	1	0 146 73	<b>Modules for EMDX<sup>3</sup> - Premium multi-function measuring units</b> RS 485 communication module MODBUS link
			1	0 146 74	Storage module Storage of active and reactive power over 62 days, the last 10 alarms and the average voltage and frequency values over 60 days max.
			1	0 146 75	Module with 2 inputs/2 outputs Up to 3 modules, i.e. 6 inputs/6 outputs, can be installed Outputs can be assigned to monitoring mode, remote control or timed remote control
			1	0 146 77	Temperature module Indication of the internal temperature and possibility of connecting 3 sensors for measuring the external temperature
1	0 146 71	<b>Modules for EMDX<sup>3</sup> - Access multi-function measuring unit</b> RS485 communication module MODBUS link			<b>Communication and supervision</b> <b>Web servers</b> Enable remote viewing, via a web browser on PCs, smartphones, web viewers, tablet computers such as iPads, Archos, etc., of values collected on electricity meters and multi-function measuring units
1	0 146 72	1-output module Can be assigned to pulse feedback, alarm feedback or control of wiring devices	1	0 261 78	For 32 metering points (meters or multi-function measuring units)
			1	0 261 79	For an unlimited number of metering points (meters or multi-function measuring units)
					<b>Legrand software dedicated to measurement</b> For displaying the values collected from electricity meters or multi-function measuring units on a PC connected to the network
			1	0 261 88	For 32 metering points (supplied on CD)
			1	0 261 89	For an unlimited number of metering points (supplied on CD)
					<b>Accessories</b> <b>IP converter</b> For RS485/Ethernet conversion for connecting electricity meters and multi-function measuring units to an IP network Supply voltage: 90-260 V~ 50/60 Hz Dimension: 2 modules
1	0 146 69	<b>EMDX<sup>3</sup> - Premium</b> <b>Multi-function measuring units</b> For mounting on door or solid faceplate Dimensions: 96 x 96 x 60 mm • LCD display • Measurement of currents, voltages, active, reactive and apparent power, internal temperature and power factor • Metering: - Active energy consumed or produced - Reactive energy consumed or produced - Operating time - Pulses • Individual harmonics up to order 63 • Programmable alarms on all functions Can take 4 optional modules			

Current transformers (CT)  
p. 88





# Incorporate measurement via **e.communication** in protection devices

Legrand is bringing a new dimension to protection devices, with measurement via e.communication directly integrated in the new DMX<sup>3</sup> and DPX<sup>3</sup> electronic circuit breakers. Measurement can be associated with DPX and DX<sup>3</sup> circuit breakers using EMDX<sup>3</sup> meters and measurement control units.

## MAIN LV DISTRIBUTION BOARD or secondary distribution board

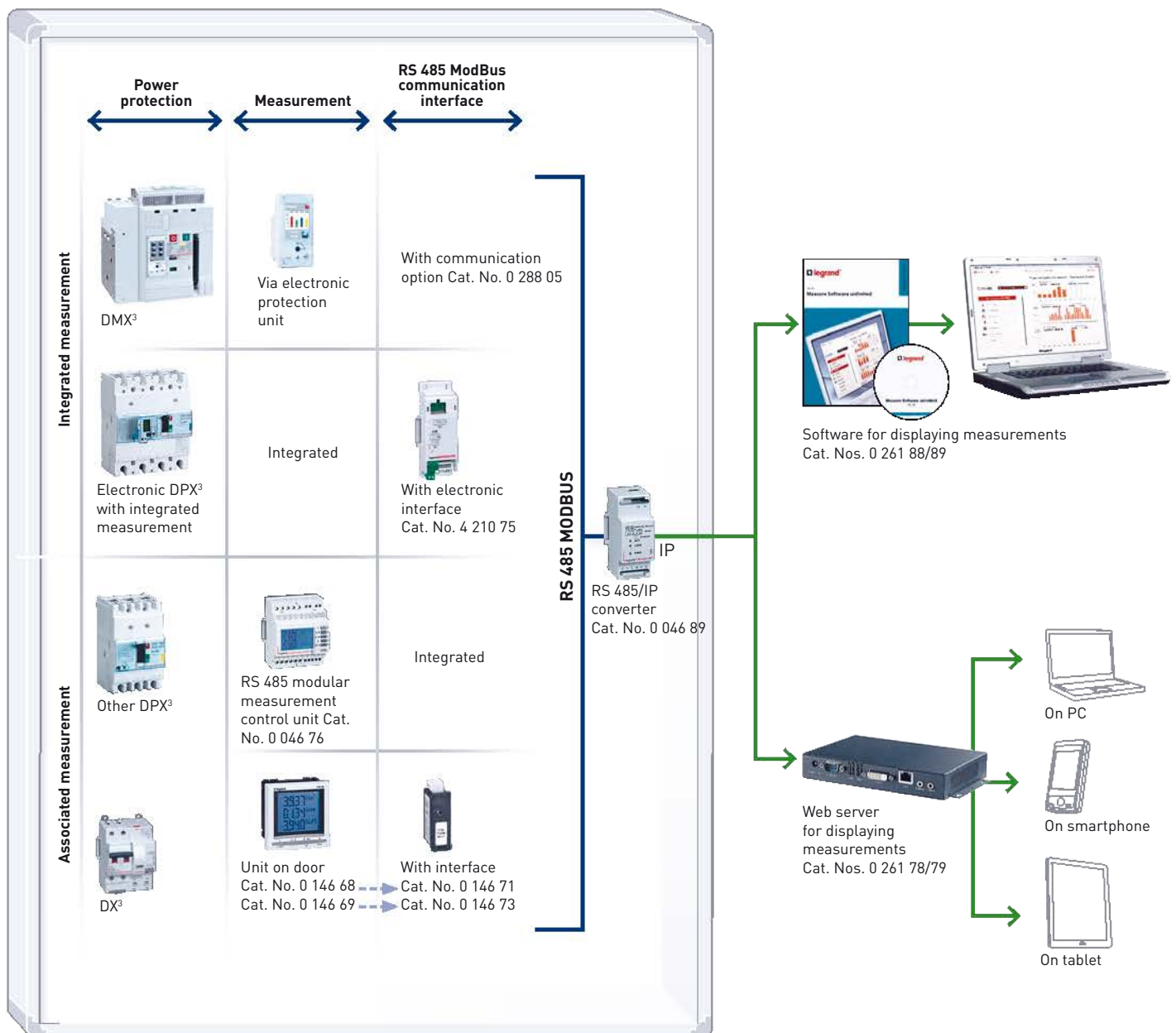

— RS 485 - Fieldbus

— IP protocol - Ethernet bus



# Power supervision system

remote control, monitoring and measurement



0 261 94



0 261 37



0 261 36



0 261 45

With the Legrand Power supervision system, circuit breakers are integrated in a supervision system. You can therefore check the status of the circuit breakers, measure the electrical values and control the circuit breakers remotely MODBUS protocol

Pack	Cat.Nos	Automation control unit
1	0 261 94	Can control supply inversion between two circuit breakers, manage generator start / stop, control single-phase, two-phase and three-phase networks, control phase-phase voltages For DPX, DPX <sup>3</sup> and DMX <sup>3</sup> circuit breakers Power supply : 230 V~ or 12/24/48 V= Plug-in terminals Communicating unit, enabling data transmission (RS 485 port)
1	0 261 37	<b>RS485 Modbus communication interfaces</b> <b>DPX electronic interface</b> For reading information from an electronic DPX : phase 1, 2 and 3 currents, the currents in the neutral, the temperature (electronic card), the nominal current and the DPX settings Dimension: 2 modules Power supply: 24 V~ / = . RS 485 link (2-wire) Address, speed and coding can be modified with configurator kit
1	4 210 75	<b>DPX<sup>3</sup> electronic interface</b> For connecting thermal-magnetic DPX <sup>3</sup> with residual current protection and electronic DPX <sup>3</sup> to an RS485 Modbus communication network All the information managed by the circuit breaker's electronic card will be shared on the Modbus network Dimension: 2 modules Power supply: 24 V~ / = . RS 485 link (2-wire) Address, speed and coding can be modified with configurator kit
1	0 288 05 <sup>1</sup>	<b>RS 485 Modbus communication option for DMX<sup>3</sup></b> Option making the DMX <sup>3</sup> capable of communicating for supervision
1	0 035 67	<b>Modular power supply</b> 230 V~ - 27 V= 2 modules
1	0 261 36	<b>DPX and DX<sup>3</sup> signalling and control interface</b> Signalling and control interface between the power supervision system and the thermal magnetic and electronic circuit breakers. Equipped with analogue / digital inputs and relay outputs. Can handle multiple circuit breakers. - 24 inputs for collecting information from the signalling auxiliaries on the DPX and DX <sup>3</sup> circuit breakers: auxiliary contact NO position (1 input) or NO+NC position (2 inputs), fault signal (1 input) - 6 outputs for: the remote control of the motor driven circuit breakers (2 outputs) and for tripping the circuit breakers for testing purposes (1 output) Dimension: 6 modules Power supply: 24 V~ / = RS 485 link (2-wire) Address, speed and coding can be modified with configuration kit.

1: Factory fitted

Pack	Cat.Nos	Accessories															
1	0 261 45	<b>Configurator kit</b> For configuring the DPX and DPX <sup>3</sup> I/O card and interface Kit with configurators 0 to 9 (10 configurators for each digit)															
1	0 466 23	<b>Single phase stabilised power supply</b> For supplying communication devices Primary 115-230 V 24 V= <table border="1"> <tr> <td>Power (W)</td> <td>Current (A)</td> <td>Flexible cable terminal capacity</td> </tr> <tr> <td>120</td> <td>5</td> <td>Input (mm<sup>2</sup>)</td> </tr> <tr> <td></td> <td></td> <td>Output (mm<sup>2</sup>)</td> </tr> <tr> <td></td> <td></td> <td>6</td> </tr> <tr> <td></td> <td></td> <td>2 x 6</td> </tr> </table>	Power (W)	Current (A)	Flexible cable terminal capacity	120	5	Input (mm <sup>2</sup> )			Output (mm <sup>2</sup> )			6			2 x 6
Power (W)	Current (A)	Flexible cable terminal capacity															
120	5	Input (mm <sup>2</sup> )															
		Output (mm <sup>2</sup> )															
		6															
		2 x 6															
1	0 046 89	<b>IP converter</b> For RS 485/Ethernet conversion for connecting electricity meters and measurement control units to an IP network Supply voltage 90-260 V~ 80/60 HZ Dimension: 2 modules															
1	0 261 78	<b>Communication and supervision</b> <b>Web servers</b> Enable remote viewing, via a web browser on PCs, smartphones, web viewers, tablet computers such as iPads, Archos, etc., of values collected on electricity meters and multi-function measuring units For 32 metering points (meters or multi-function measuring units)															
1	0 261 79	For an unlimited number of metering points (meters or multi-function measuring units)															
1	0 261 88	<b>Legrand software dedicated to measurement</b> For displaying the values collected from electricity meters or multi-function measuring units on a PC connected to the network															
1	0 261 89	For 32 metering points (supplied on CD) For an unlimited number of metering points (supplied on CD)															

Electronic DPX<sup>3</sup> 250 with integrated measurement unit **p. 124**

EMDX<sup>3</sup> measurement control units **p. 85**



## Current transformers CT



0 047 79

### Pack Cat.Nos Single-phase current transformers (CT)

Used with ammeters, electricity meters or multi-function measuring units  
Provide a 0 to 5 A current at the secondary, proportional to the primary current  
For fixing on plates, EN 60715 rail  
Cat.Nos 0 046 31/34/36, or bars  
Secondary connected by terminals or lugs  
Precision class 1%

#### For 16 x 12.5 mm bar and Ø21 mm cable

	Transformation ratio	Output (VA)
1	0 046 31 50/5	1.25
1	0 046 34 100/5	2.5
1	0 046 36 200/5	5.5

#### For 20.5 x 12.5 and 30 x 10.5 mm bar and Ø23 mm cable

1	0 047 75 300/5	11
---	----------------	----

#### For 40.5 x 10.5 mm bar and Ø35 mm cable

1	0 046 38 400/5	12
---	----------------	----

#### For 65 x 32 mm bar

1	0 047 76 600/5	12
1	0 047 77 800/5	15
1	0 047 78 1000/5	20

#### For 84 x 34 mm bar

1	0 047 79 1250/5	15
---	-----------------	----

#### For 127 x 38 mm bar

1	0 046 45 1500/5	15
1	0 046 46 2000/5	20

#### For 127 x 54 mm bar

1	0 047 80 2500/5	50
1	0 046 48 4000/5	50

### Three-phase current transformers (CT)

Used with ammeters, electricity meters or multi-function measuring units  
Provide a 0 to 5 A current at the secondary, proportional to the primary current  
For fixing directly on bars  
Secondary connected by terminals or lugs  
Precision class 1%

#### For three 20.5 x 5.5 mm bars

	Transformation ratio	Output (VA)
1	0 046 98 250/5	3

#### For three 30.5 x 5.5 mm bars

1	0 046 99 400/5	4
---	----------------	---

### Viking 3 disconnecter block for measurement 1 connection

With its accessories, allows intervention (measurement, maintenance, etc) on a current, voltage and power measuring circuit by keeping the current transformer secondary circuit closed

Pack	Cat.Nos	Colour	Nominal cross section (mm <sup>2</sup> )	Capacity		Pitch (mm <sup>2</sup> )
				Rigid wire (mm <sup>2</sup> )	Flexible wire (mm <sup>2</sup> )	
25	0 371 92	Grey	4	0.25 to 4	0.25 to 4	8

## Current transformers CT

### Current transformers (CT)

#### Technical characteristics

Degree of protection: IP 20

Operating frequency: 50/60 Hz

#### Dimensions

• Single-phase CTs

Cat.Nos 0 046 31/34/36 for 16 x 12.5 mm bar and Ø21 mm cable

Fixing on EN 60715 rail

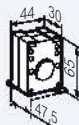

Cat.No 0 047 75 for 20.5 x 12.5 and 30 x 10.5 mm bar and Ø23 mm cable

Cat.No 0 046 38 for 40.5 x 10.5 mm bar and Ø35 mm cable

Fixing on EN 60715 rail or on plate

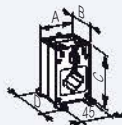

Cat.Nos	A	B	C	D	Ø	Fixing centres on plate
0 047 75	56	42	94	50	23	50 x 45
0 046 38	77	46	107	54	35	54 x 45

Cat.Nos 0 047 76/77/78 for 65 x 32 mm bar

Cat.No 0 047 79 for 84 x 34 mm bar

Fixing on bar

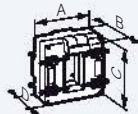

Cat.Nos	A	B	C	D
0 047 76/77/78	90	90	94	40
0 047 79	96	87	116	58

Cat.Nos 0 046 45/46 for 127 x 38 mm bar

Cat.Nos 0 047 80 and 0 046 48 for 127 x 54 mm bar

Fixing on bar

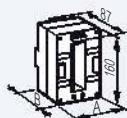

Cat.Nos	A	B
0 046 45/46	99	58
0 046 48/0 047 80	125	40

• Three-phase CT

Cat.No 0 046 98 for three 20.5 x 5.5 mm bars

Cat.No 0 046 99 for three 30.5 x 5.5 mm bars

Fixing on bar

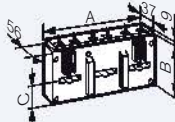

Cat.Nos	A	B	C
0 046 98	107	58.5	25
0 046 99	135	66.5	30

### Determination of the max. distance between CT and meter

Cat.Nos	Max. power of CT	Meter consump. (W)	Max. loss in capac. (VA)	Max. distance bet. CT & meter (m)		
				Wiring 2.5 mm <sup>2</sup>	Wiring 4 mm <sup>2</sup>	Wiring 6 mm <sup>2</sup>
0 046 31	1.25	0.5	0.75	1.8	2.7	3.9
0 046 34	2.5	0.5	2	4.9	7.1	10.4
0 046 98	3	0.5	2.5	6.1	8.9	13
0 046 99	4	0.5	3.5	8.5	12.4	18.1
0 046 36	5.5	0.5	5	12.2	17.8	25.9
0 047 75	11	0.5	10.5	25.5	37.3	54.4
0 046 38 0 047 76	12	0.5	11.5	28	40.8	59.6
0 047 77/79 0 046 45	15	0.5	14.5	35.3	51.5	75.2
0 046 46 0 047 78	20	0.5	19.5	47.4	69.3	101.1
0 047 80 0 046 48	50	0.5	49.5	120.4	175.8	256.7

# EMDX<sup>3</sup> electrical energy meters

└ rail mounting

## Technical characteristics

### Single-phase meters Cat.Nos 0 046 70/72/77/78/79/81

LCD display: 7 digits  
 Resolution: 0.1 kWh  
 Maximum indication: 99999.9 kWh  
 Metrological LED: 1 Wh/pulse (Cat.No 0 046 70 : 0.5 Wh/pulse)  
 Accuracy (EN 62053-21): class 1  
 Reference voltage Un: 230 V-240 V  
 Reference frequency: 50-60 Hz

### Three-phase meters Cat.Nos 0 046 73/74/80/82/83/84/85/86

LCD display: 8 digits  
 Resolution: 0.01 kWh<sup>(1)</sup>  
 Maximum indication: 99999.99 kWh<sup>(1)</sup>  
 Metrological LED: 0.1 Wh/pulse or 1 Wh/pulse  
 Active energy accuracy (EN 62053-21): class 1  
 Reactive energy accuracy (EN 62053-23): class 2  
 Reference voltage Un:  
 - Single-phase: 230-240 V  
 - Three-phase: 230(400)-240(415) V  
 Operating limit range (EN 62053-21, EN 62053-23):  
 - Single-phase: 110 to 254 V  
 - Three-phase: 110(190) to 254(440) V  
 Pulse output: 1 pulse/10 Wh

Cat.Nos		0 046 70	0 046 81	0 046 72	0 046 77	0 046 78	0 046 79	0 046 73	0 046 80	0 046 82	0 046 83	0 046 74	0 046 84	0 046 85	0 046 86	
Number of modules		1	2	2	2	2	2	4	4	4	4	4	4	4	4	
Connection	Direct	●	●	●	●	●	●	●	●	●	●					
	Via a current transformer											●	●	●	●	
	Single-phase	●	●	●	●	●	●					●	●			
	Three-phase											●	●	●	●	
Max. current		32 A	36 A	63 A	63 A	63 A	63 A	63 A	63 A	63 A	63 A	5 A (CT)	5 A (CT)	5 A (CT)	5 A (CT)	
Metering and measurement	Total active energy	●	●	●	●	●	●	●	●	●	●	●	●	●	●	
	Total reactive energy							●	●	●	●	●	●	●	●	
	Partial active energy (reset)		●	●	●	●	●	●	●	●	●	●	●			
	Partial reactive energy (reset)							●	●	●	●	●	●			
	Active power			●	●	●	●	●	●	●	●	●	●	●	●	
	Reactive power							●	●	●	●	●	●	●	●	
	Apparent power							●	●	●	●	●	●	●	●	
	Current			●	●	●	●	●	●	●	●	●	●	●	●	
	Voltage			●	●	●	●	●	●	●	●	●	●	●	●	
	Frequency			●	●			●	●	●	●	●	●	●	●	
	Power factor			●	●			●	●	●	●	●	●	●	●	
	Time-of-use			●	●											
	Average active power							●	●	●	●	●	●	●	●	
	Max. average active power value							●	●	●	●	●	●	●	●	
Dual tariff								●								
Communication	Pulse output	●	●	●	●	●		●		●		●	●	●	●	
	RS 485 interface				●		●		●		●		●		●	
MID compliant					●	●			●				●	●		
Operating conditions	Reference temperature	23 °C ± 2 °C														
	Operating temperature	-20 to +55 °C			-10 to +45 °C				-5 to +55 °C							
	Storage temperature	-40 to +70 °C			-25 to +70 °C				-25 to +70 °C							
	Consumption	≤ 8 VA			≤ 4 VA				≤ 4 VA per phase				≤ 1 VA per phase			
	Heat dissipation	≤ 6.5 W			≤ 6 W				≤ 6 W				≤ 4 W			

## Interfacing with IP communication network

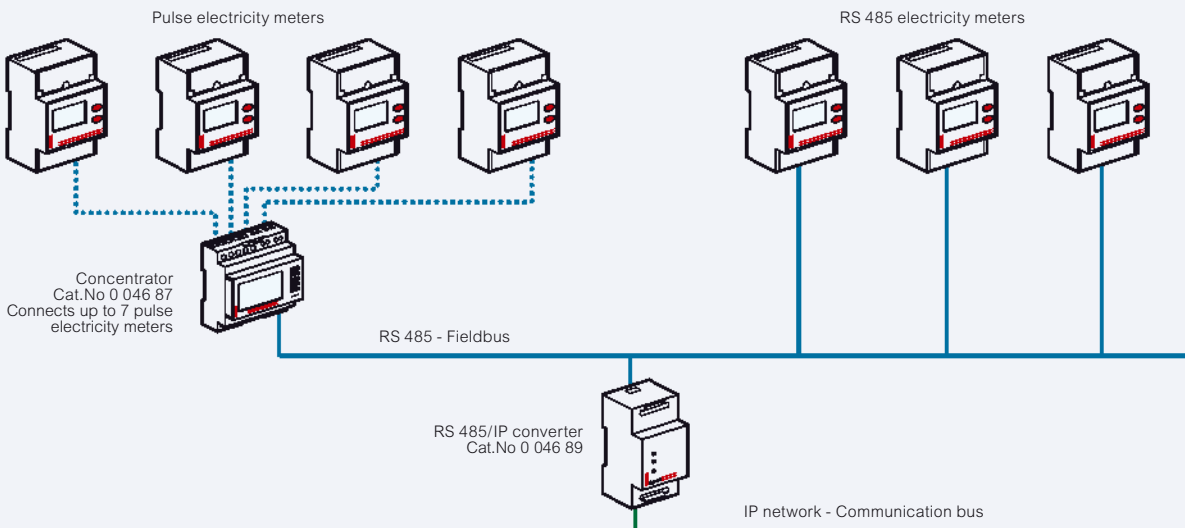

1: For direct connection meters  
 If connected via transformers, the resolution and maximum indication depend on the transformation ratios of these transformers

## Technical characteristics

Cat.Nos		0 046 75/76	0 146 68	0 146 69	
Connection	Current measurement terminals	4 mm <sup>2</sup>	6 mm <sup>2</sup>	6 mm <sup>2</sup>	
	Other terminals	2.5 mm <sup>2</sup>	2.5 mm <sup>2</sup>	2.5 mm <sup>2</sup>	
Protection index	Front cover	IP 51	IP 52	IP 52	
	Casing	IP 20	IP 30	IP 30	
Weight		205/215 g	400 g	400 g	
Display		Backlit LCD	Backlit LCD	Backlit LCD	
Measurements		3P+N, 3P, 2P, 1P+N	3P+N, 3P, 2P, 1P+N	3P+N, 3P, 2P, 1P+N	
Voltage measurement	Direct	Phase/phase	50 to 520 V~	50 to 500 V~	18 to 700 V~
		Phase/neutral	28 to 300 V~	28 to 289 V~	11 to 404 V~
	From a PT	Primary	-	-	≤ 500 kV
		Secondary	-	-	60, 100, 110, 115, 120, 173, 190 V~
	Permanent overload between phases		760 V~	800 V~	760 V~
	Update period		1 s	1 s	1 s
Current measurement	From a CT	Primary	5 to 9999 A	≤ 9999 A	≤ 9995 A
		Secondary	5 A	5 A	1 or 5 A
	Minimum measurement		5 mA	5 mA	10 mA
	Input consumption		< 0.6 VA	< 0.6 VA	< 0.3 VA
	Display		0 to 9999 A	1 to 11 kA	0 to 11 kA
	Permanent overload		6 A	6 A	10 A
	Intermittent overload		60 A/1 s - 120 A/0.5 s	10 In/1 s	10 In/1 s
	Update period		1 s	1 s	1 s
	Max. CT x PT ratio		-	-	10000000
	Power measurement	Total	0 to 9999 kW/kvar/kVA	0 to 11 MW/Mvar/MVA	0 to 8000 MW/Mvar/MVA
Update period			1 s	1 s	
Frequency measurement	Measurement range	45.0 to 65.0 Hz	45.0 to 65.0 Hz	45.0 to 65.0 Hz	
	Update period		1 s	1 s	
Auxiliary power supply	50/60 Hz	200 to 277 V~ ±15%	110 to 400 V~ ±10%	110 to 400 V~ ±10%	
	DC	-	120 to 350 V= ±20%	120 to 350 V= ±20%	
	Consumption	< 5 VA	< 10 VA	< 10 VA	
Operating temperature		-10 °C to +55 °C	-10 °C to +55 °C	-10 °C to +55 °C	
Storage temperature		-20 °C to +70 °C	-20 °C to +85 °C	-20 °C to +85 °C	

## Flush-mounting dimensions Cat.Nos 0 146 68/69

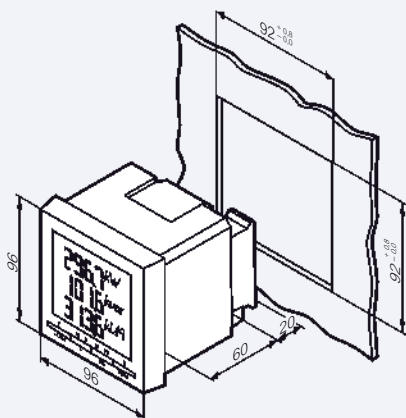

## Fixing on door Cat.Nos 0 146 68/69

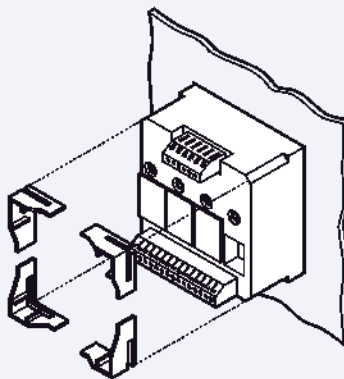

## Fitting modules Cat.Nos 0 146 68/69

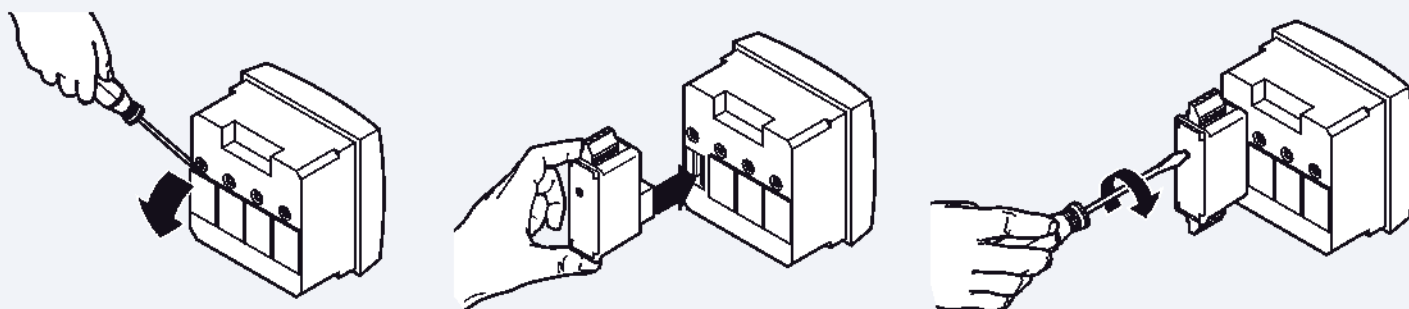

## Connection solutions

### Unbalanced three-phase network (3 or 4-wire)

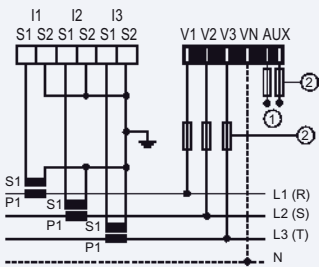

### (3-wire)

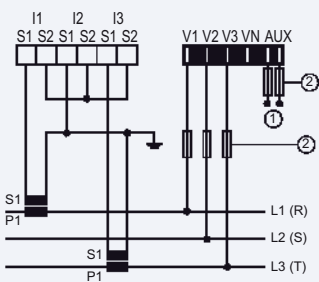

### Balanced three-phase network (3 or 4-wire)

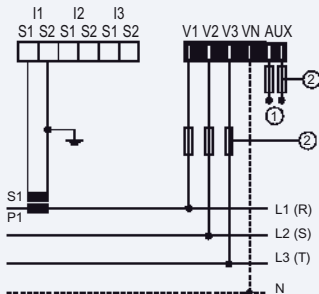

### Single-phase network (2-wire)

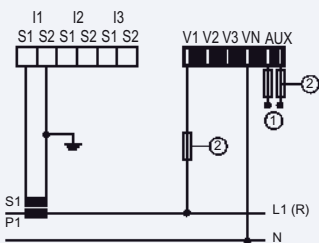

### Two-phase network (2-wire)

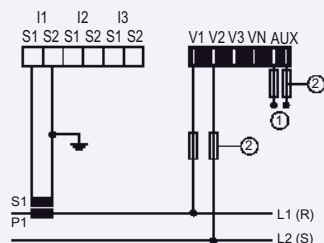

- ① Auxiliary power supply: 110 ... 400 VAC/120 ... 350 VDC  
 ② Fuse: 0.5 A gG/BS 88 2A gG/0.5 A class CC

## Wiring example of communication network

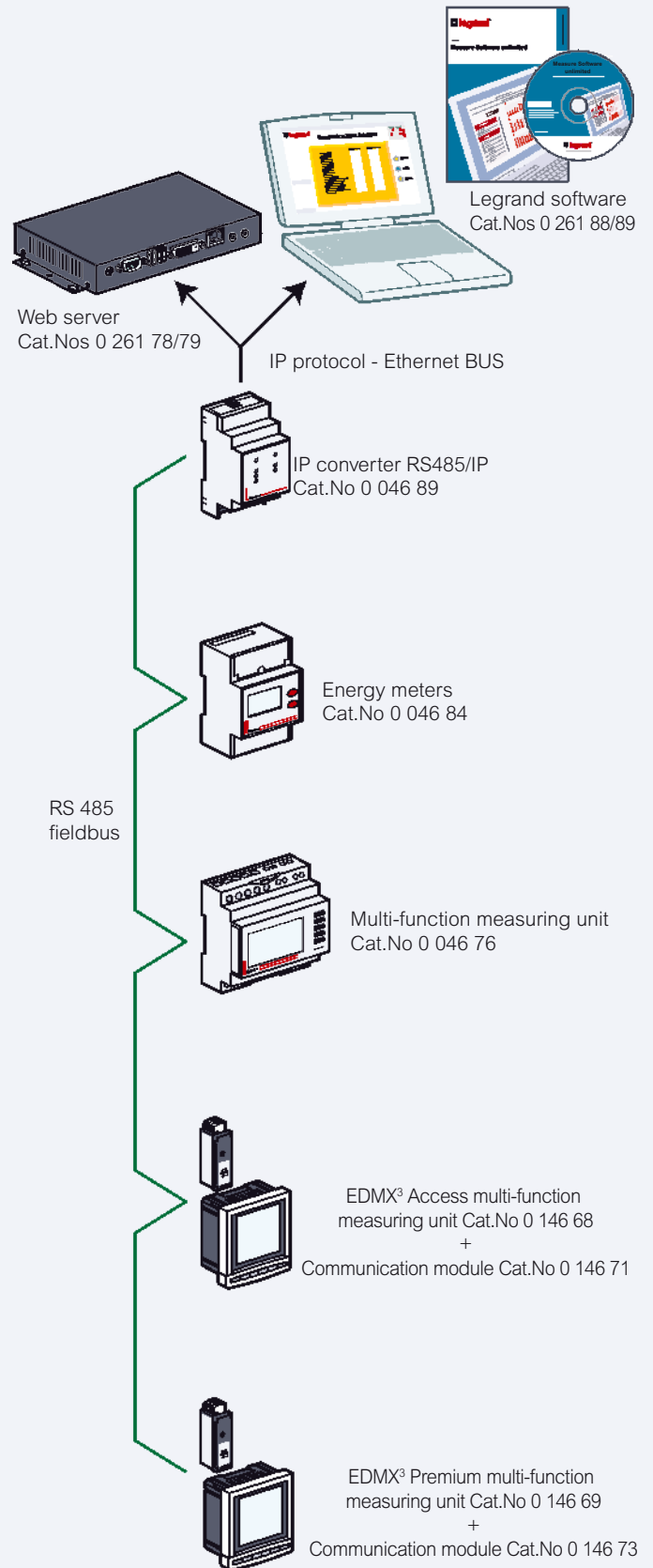



Dimensions **see e-catalogue**

Pack	Cat.Nos	Analogue metering devices	Number of modules
1	0 046 02	<b>Ammeters</b> Measure the intensity in Amperes (A) of the current circulating in an electrical circuit Direct connection AC or DC	4
1	0 046 00	Scale: 0 - 30 A - supplied with dial Connected via a 0 - 5 A output current transformer (CT)	4
<b>Measuring dials for ammeter Cat.No 0 046 00</b>			
2	0 046 10	0-50 A	
2	0 046 13	0-100 A	
2	0 046 15	0-200 A	
2	0 046 16	0-250 A	
2	0 046 17	0-300 A	
2	0 046 18	0-400 A	
2	0 046 20	0-600 A	
2	0 046 21	0-800 A	
2	0 046 22	0-1000 A	
2	0 046 66	0-1250 A	
2	0 046 24	0-1500 A	
2	0 046 25	0-2000 A	
1	0 046 60	<b>Voltmeter</b> Measure the AC or DC voltage in a circuit in volts (V) Scale: 0-500 V	
1	0 046 63	<b>Digital ammeter / voltmeter</b> Connection: - Ammeter mode: connected via a 0 - 5 A current transformer (CT) Reading range adjusted according to CT used - Voltmeter mode: measures the AC or DC voltage of an electrical circuit; scale 0 - 600 V Voltage: 230 V~ - 50/60 Hz Reading: I - 0 to 8000 A U - 0 to 500 V	4

Pack	Cat.Nos	Selective measurement switches	Number of modules
For manual selection of the circuits to be measured			
<b>Ammeter cam switch</b> For measuring the current in a circuit with one ammeter, connected via a current transformer (CT)			
1	0 046 50	3-phase, 4-position cam switch	3
<b>Voltmeter cam switches</b> For measuring the voltages in a circuit with one voltmeter			
1	0 046 52	3-phase, 4-position cam switch	3
1	0 046 53	3-phase with neutral, 7-position cam switch	3
<b>Digital frequency meter</b> For measuring the frequency of a 230 V~ electrical circuit in hertz (Hz) Supply voltage 230 V~ (connected to circuit to be measured) Green LED 3 digit display - 40-80 Hz display			
1	0 046 64		4
<b>Totalising hour counters</b> Count the operating hours of a machine or an electrical device to determine its exact operating time Counter with numerical display Capacity: 5 digits + 2 decimal places (1 unit = 1 hour) Precision: 1/100th hour Consumption: 0.2 VA			
1	0 046 94	230 V~ - 50 Hz	2
1	0 046 91	24 V~ - 50 Hz	2



## Electrical energy metering on door



0 146 00 + 0 146 16



0 146 61



0 495 55

Ammeters, voltmeters, totalising, can be mounted on XL<sup>3</sup> 800 and XL<sup>3</sup> 4000 curved doors

### Pack Cat.Nos Analogue metering devices

Pack	Cat.Nos	Analogue metering devices
<b>Ammeters</b>		
Measure the intensity in amperes (A) of the current Connected via a 0 - 5 A output current transformer (CT) To be fitted with a measuring dial appropriate for the current to be measured		
1	0 146 00	Round barrel Ø56 mm
1	0 146 01	Square barrel 68 x 68 mm
<b>Measuring dial for ammeters</b>		
Supplied by set of 2 (1 for round barrel, 1 for square barrel)		
1	0 146 10	0 - 50 A
1	0 146 13	0 - 100 A
1	0 146 15	0 - 200 A
1	0 146 16	0 - 250 A
1	0 146 17	0 - 300 A
1	0 146 18	0 - 400 A
1	0 146 20	0 - 600 A
1	0 146 21	0 - 800 A
1	0 146 22	0 - 1000 A
1	0 146 66	0 - 1250 A
1	0 146 24	0 - 1500 A
1	0 146 25	0 - 2000 A
1	0 146 26	0 - 2500 A
1	0 146 28	0 - 4000 A
<b>Voltmeters</b>		
Measure the voltage in volts (V) AC ou DC Scale: 0 - 500 V		
1	0 146 60	Round barrel Ø56 mm
1	0 146 61	Square barrel 68 x 68 mm

### Totalising hour counters (48 x 48)

Pack	Cat.Nos	Totalising hour counters (48 x 48)
One-piece device - IP 40 Front mounting on enclosure or cabinet doors Synchronous motor operation (operation indicator) For counting the operating hours of an electrical machine or device, with no reset Supplied with cover frame (55 x 55 mm) (for round cut-out) and fixing accessories Connection: 2 x 1.5 mm <sup>2</sup>		
1	0 495 52	24 V~ - 50 Hz
1	0 495 53	110 to 120 V~ - 50 Hz
1	0 495 54	110 to 120 V~ - 60 Hz
1	0 495 55	200 to 240 V~ - 50 Hz
1	0 495 58	48 V~ - 50 Hz
1	0 495 59	400 V~ - 50 Hz
1	0 495 60	12 to 36 V <sub>DC</sub>
100	0 495 97	Frame 55 x 55 mm

## Electrical energy metering

### Metering devices on rail

#### Technical characteristics

Analogue ammeters

Type of measurement	Analogue	
	Ferromagnetic	
Frequency	50 to 60 Hz	
Precision	1.5 %	
Operating temperature	- 10 °C to + 40 °C	
Storage temperature	- 20 °C to + 80 °C	
Consumption:		
• voltage circuit	-	
• measurement circuit	1.1 VA	
Connection capacity	Direct	Par TI
	6 mm <sup>2</sup>	4 mm <sup>2</sup>
Conformity to standards	NF EN 61010-1	

Analogue Voltmeters

Type of measurement	Analogue	
	Ferromagnetic integration	
Frequency	50 to 60 Hz	
Precision	1.5 %	
Operating temperature	- 10 °C to + 40 °C	
Storage temperature	- 20 °C to + 80 °C	
Consumption	3 VA	
Connection capacity	2 x 2.5 mm <sup>2</sup>	
Conformity to standards	NF EN 61010-1	

Digital frequency meter

Type of measurement	Quartz electronic
Precision	± 0.2 % for ± 1 digit
Operating temperature	- 10 °C to + 40 °C
Storage temperature	- 20 °C to + 70 °C
Consumption	4.5 VA
Connection capacity	2 x 2.5 mm <sup>2</sup>
Conformity to standards	NF EN 61010-1

### Analogue metering devices on door

#### Technical characteristics

Frequency: 50/60 Hz  
Precision class: 1.5 %  
Operating temperature: - 10 °C to + 40 °C  
Storage temperature: - 20 °C to + 80 °C  
Consumption:  
- ammeter: 1.1 VA  
- voltmeter: 3 VA  
Connection capacity: 2 x 2.5 mm<sup>2</sup> with screws or  
Conform to IEC 60051, VDE 0410, BS 89, EN 60051-1, cenelec HD 223

#### Dimensions

Cat.Nos 0 146 01/61

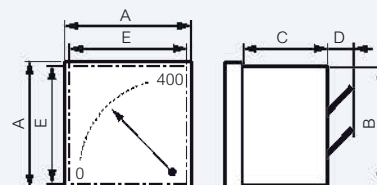

Dimensions (mm)				
A	B	C	D	E
72	66.5	44	12	68±0,7

Cat.Nos 0 146 00/60

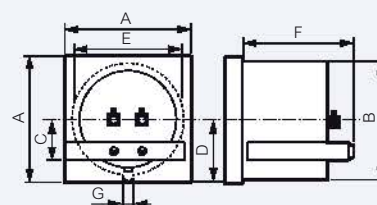

Dimensions (mm)						
A	B	C	D	E	F	G
72	Ø55	21.4	28.5	56	46	3.2



4 151 80

4 151 83

4 151 84

4 151 86

Compact design in cylindrical aluminium can  
 Biodegradable soft resin impregnant  
 Dual safety with self healing and overpressure disconnecter  
 Conforming to standard IEC 60831-1 and 2

**Three-phase 400 V - 50 Hz**

Pack	Cat.Nos	Nominal power (kVA <sub>r</sub> )	
		50 Hz	60 Hz
		<b>440 V max.</b>	
1	4 151 60	2.5	3
1	4 151 61	5	6
1	4 151 62	6.3	7.6
1	4 151 63	7.5	9
1	4 151 64	10	12
1	4 151 65	12.5	15
1	4 151 66	15	18
1	4 151 67	20	24
1	4 151 68	25	30

**Three-phase 415 V - 50 Hz**

Pack	Cat.Nos	Nominal power (kVA <sub>r</sub> )	
		50 Hz	60 Hz
		<b>456 V max.</b>	
1	4 151 69	2.5	3
1	4 151 70	5	6
1	4 151 71	6.3	7.6
1	4 151 72	7.5	9
1	4 151 73	10	12
1	4 151 74	12.5	15
1	4 151 75	15	18
1	4 151 76	20	24
1	4 151 77	25	30

**Three-phase 440 V - 50 Hz**

Pack	Cat.Nos	Nominal power (kVA <sub>r</sub> )	
		50 Hz	60 Hz
		<b>484 V max.</b>	
1	4 151 78	2.5	3
1	4 151 79	5	6
1	4 151 80	6.3	7.6
1	4 151 81	7.5	9
1	4 151 82	10	12
1	4 151 83	12.5	15
1	4 151 84	15	18
1	4 151 85	20	24
1	4 151 86	25	30
1	4 151 87	30	36

**Three-phase 480 V - 50 Hz**

Pack	Cat.Nos	Nominal power (kVA <sub>r</sub> )	
		50 Hz	60 Hz
		<b>528 V max.</b>	
1	4 151 88	5	6
1	4 151 89	10.4	12.5
1	4 151 90	12.5	15
1	4 151 91	15	18
1	4 151 92	20.8	25
1	4 151 93	25	30
1	4 151 94	30	36



# Alpican capacitors

## technical characteristics

### Technical specifications

#### Discharge resistors:

Fitted inside, they discharge the unit in accordance with current standards (discharge time, 3 minutes)

#### Loss factor:

Alpican capacitors have a loss factor of less than  $0.2 \times 10^{-3}$ . This value leads to a power consumption of less than 0.45 W per kVAr, excluding the discharge resistors

**Rated frequency:** 50/60 Hz

**Capacitance:** tolerance on the capacitance value: - 5 % / 10 %

#### Max. permissible voltage:

1.1 Un up to 8 hours daily (according to IEC 60831-1 and 2)

#### Max. permissible current:

Up to 1.5 Ir including combined effects of harmonics (according to IEC 60831-1 and 2)

**Inrush current:** up to 200 Ir

**Insulation class:** 3/15 kV

#### Standards:

Alpican capacitors comply with:  
• International standard: IEC 60831-1 and 2

#### Temperature class:

Alpican capacitors are designed for a standard -25D temperature class

- Maximum temperature: 55 °C
- Average over 24 hours: 45 °C
- Annual average: 35 °C
- Lowest temperature class: - 25 °C

**Cooling:** natural or forced

**Humidity:** max. 95 %

**Altitude:** max. 4000 m above the sea level

**Mounting position:** vertical

### Dimensions

For capacitors from 2.5 to 5 kVAr - 400 V, 415 V and 440 V

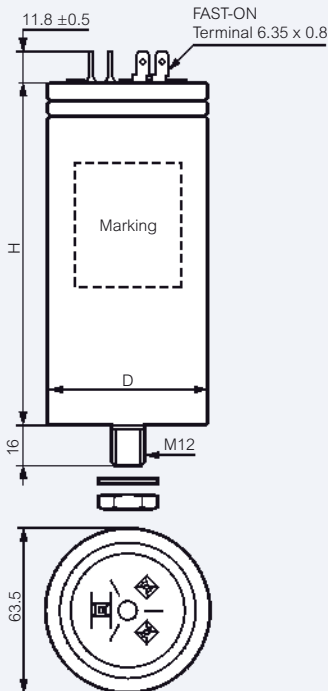

Creepage distance:  
•  $\varnothing 63.5$ : 10.0 mm

Clearance:  
•  $\varnothing 63.5$ : 16.5 mm

Mounting:  
•  $\varnothing 63.5$ :  
M 12, torque 10 Nm  
Toothed washer J 12.5 DIN 6797  
Hex nut BM 12 DIN 439

Cat.No	Nominal power at 50 Hz (kVAr)	Dimensions (mm)			Weight (kg)
		D	H	max. A	
4 151 60	2.5	63.5	129	12	0.4
4 151 61	5	63.5	129	12	0.4
4 151 69	2.5	63.5	129	13	0.4
4 151 70	5	63.5	129	12	0.4
4 151 78	2.5	63.5	129	12	0.3
4 151 79	5	63.5	154	12	0.5

### Dimensions (continued)

For capacitors from 6.3 to 30 kVAr - 400 V, 415 V, 440 V and full range of 480 V capacitors

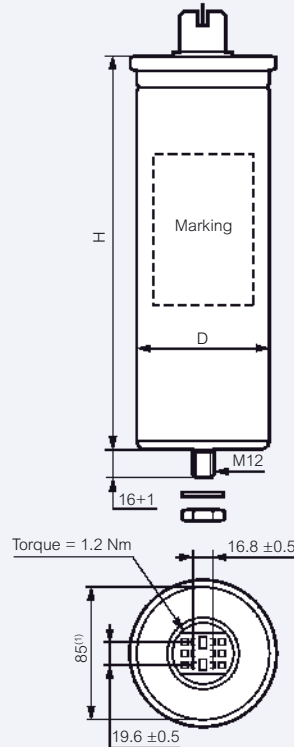

(1) Seaming adds 4 mm in diameter

Creepage distance:  
•  $\varnothing 75 / \varnothing 85$ : 9.6 mm

Clearance:  
•  $\varnothing 75 / \varnothing 85$ : 12.7 mm

Mounting:  
•  $\varnothing 75 / \varnothing 85$ :  
M 12, torque 10 Nm  
Toothed washer J 12.5 DIN 6797  
Hex nut BM 12 DIN 439

Cat.No	Nominal power at 50 Hz (kVAr)	Dimensions (mm)			Weight (kg)
		D	H	max. A	
4 151 62	6.3	75	160	13	0.5
4 151 63	7.5	75	160	13	0.5
4 151 64	10	75	198	13	0.6
4 151 65	12.5	85	198	13	0.8
4 151 66	15	85	198	13	0.8
4 151 67	20	85	273	13	1.1
4 151 68	25	85	273	13	1.5
4 151 71	6.3	75	160	13	0.5
4 151 72	7.5	75	198	13	0.6
4 151 73	10	75	198	13	0.6
4 151 74	12.5	85	198	13	0.8
4 151 75	15	85	273	13	1.2
4 151 76	20	85	273	13	1.2
4 151 77	25	85	348	13	1.5
4 151 80	6.3	75	160	13	0.5
4 151 81	7.5	75	160	13	0.5
4 151 82	10	75	198	13	0.6
4 151 83	12.5	85	198	13	0.8
4 151 84	15	85	273	13	1.2
4 151 85	20	85	273	13	1.2
4 151 86	25	85	348	13	1.5
4 151 87	30	85	348	13	1.6
4 151 88	5	75	160	13	0.5
4 151 89	10.4	85	198	13	0.8
4 151 90	12.5	85	198	13	0.8
4 151 91	15	85	273	13	1.2
4 151 92	20.8	85	273	13	1.2
4 151 93	25	85	348	13	1.5
4 151 94	30	90	348	13	1.5



V2540CB

Double or class II insulation. Totally dry  
Self-extinguishing polyurethane resin casing. Internal protection for each winding using:

- A self-healing metallised polypropylene film
- An electric fuse
- A disconnection device in case of overpressure

Colour: Casing RAL 7035 Cover RAL 7001  
Conforming to standards EN and IEC 60831-1 and 2

Pack	Cat.Nos	Standard type three-phase 400 V - 50 Hz
		<b>470 V max.</b>
		Harmonic pollution SH/ST ≤ 15%
		Nominal power (kVAr)
1	V2.540CB	2.5
1	V540CB	5
1	V7.540CB	7.5
1	V1040CB	10
1	V12.540CB	12.5
1	V1540CB	15
1	V2040CB	20
1	V2540CB	25
1	V3040CB	30
1	V3540CB	35
1	V4040CB	40
1	V5040CB	50
1	V6040CB	60
1	V7540CB	75
1	V9040CB	90
1	V10040CB	100
1	V12540CB	125

Pack	Cat.Nos	H type three-phase 400 V - 50 Hz
		<b>520 V max.</b>
		Harmonic pollution 15% < SH/ST ≤ 25%
		Nominal power (kVAr)
1	VH2.540CB	2.5
1	VH540CB	5
1	VH7.540CB	7.5
1	VH1040CB	10
1	VH12.540CB	12.5
1	VH1540CB	15
1	VH2040CB	20
1	VH2540CB	25
1	VH3040CB	30
1	VH3540CB	35
1	VH4040CB	40
1	VH5040CB	50
1	VH6040CB	60
1	VH7540CB	75
1	VH8040CB	80
1	VH9040CB	90
1	VH10040CB	100
1	VH12540CB	125

## Technical specifications

### Discharge resistors

Fitted inside (except by special request), these discharge the unit in accordance with current standards (discharge time, 3 minutes)

### Loss factor

Alpivar<sup>2</sup> capacitors have a loss factor of less than  $0.1 \times 10^{-3}$   
This value leads to a power consumption of less than 0.3 W per kVAr, including the discharge resistors.

### Capacitance

Tolerance on the capacitance value: ± 5%  
Our manufacturing process, which avoids any inclusion of air in the coils, ensures excellent stability of the capacitance throughout the service life of the Alpivar<sup>2</sup> capacitor.

**Max. permissible voltage:** 1.18 Un rated

### Max. permissible current:

- Standard type: 1.3 In
- H type: 1.5 In

### Insulation class

- Withstand at 50 Hz for 1 min: 6 kV
- 1.2/50 µs impulse withstand: 25 kV

### Standards

Alpivar<sup>2</sup> capacitors comply with:  
• French standard: NF EN 60831-1 and 2  
• European standard: EN 60831-1 and 2  
• International standard: IEC 60831-1 and 2  
• End of life performance tests performed successfully in EDF and LCIE laboratories

### Temperature class

Alpivar<sup>2</sup> capacitors are designed for a standard temperature class -25/+55°C

- Maximum temperature: 55°C
- Average over 24 hours: 45°C
- Annual average: 35°C
- Other temperature classes on request

## Dimensions

### Standard type / H type - Three-phase

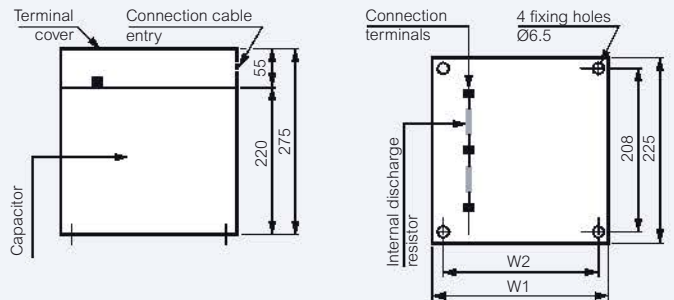

Standard type	H type	Dimensions (mm)			Weight (kg)
		W1	W2	H	
V2.540CB	VH2.540CB	90	70	275	3.5
V540CB	VH540CB	90	70	275	3.5
V7.540CB	VH7.540CB	90	70	275	3.5
V1040CB	VH1040CB	90	70	275	3.5
V12.540CB	VH12.540CB	90	70	275	3.5
V1540CB	VH1540CB	90	70	275	3.5
V2040CB	VH2040CB	90	70	275	3.5
V2540CB	VH2540CB	90	70	275	3.5
V3040CB	VH3040CB	180	156	275	7
V3540CB	VH3540CB	180	156	275	7
V4040CB	VH4040CB	180	156	275	7
V5040CB	VH5040CB	180	156	275	7
V6040CB	VH6040CB	270	244	275	10.5
V7540CB	VH7540CB	270	244	275	10.5
	VH8040CB	360	332	275	14
V9040CB	VH9040CB	360	332	275	14
V10040CB	VH10040CB	360	332	275	14
V12540CB	VH12540CB	450	419	275	17.5

# Fixed capacitor banks Alplibloc

400 V network



B6040

Alplibloc is an Alpivar<sup>2</sup> capacitor with built-in circuit breaker  
 Assembly fitted and wired in an IP 31 - IK 05 box or cabinet  
 Equipment supplied ready for connection, for fixed compensation of low and medium power electrical devices  
 For certain applications (remote control, etc.) the circuit breaker can be replaced by a contactor and HRC fuses (on request)  
 Conforming to standards EN and IEC 60831-1 and 2

Pack	Cat.Nos	<b>Standard type three-phase 400 V - 50 Hz</b>	
		<b>470 V max.</b>	
		Harmonic pollution 15% ≤ SH/ST	
		Nominal power (kVAr)	Circuit breaker I <sub>sc</sub> (kA)
1	B1040	10	50
1	B1540	15	50
1	B2040	20	50
1	B2540	25	50
1	B3040	30	50
1	B4040	40	25
1	B5040	50	25
1	B6040	60	25
1	B7540	75	25
1	B9040	90	36
1	B10040	100	36
1	B12540	125	36
1	B15040	150	36
1	B17540	175	36

Pack	Cat.Nos	<b>H type three-phase 400 V - 50 Hz</b>	
		<b>520 V max.</b>	
		Harmonic pollution 15% < SH/ST ≤ 25%	
		Nominal power (kVAr)	Circuit breaker I <sub>sc</sub> (kA)
1	BH1040	10	50
1	BH1540	15	50
1	BH2040	20	50
1	BH2540	25	50
1	BH3040	30	50
1	BH4040	40	25
1	BH5040	50	25
1	BH6040	60	25
1	BH7540	75	25
1	BH9040	90	36
1	BH10040	100	36
1	BH12540	125	36
1	BH15040	150	36
1	BH17540	175	36

# Fixed capacitor banks Alplibloc

## Dimensions

### Standard type - Three-phase

Cat.Nos	Dimensions (mm)			Weight (kg)
	Height	Width	Depth	
B1040	380	190	230	5
B1540	380	190	230	5
B2040	380	190	230	5
B2540	380	190	230	7.5
B3040	380	190	230	10
B4040	380	365	230	10
B5040	380	365	230	12.5
B6040	380	365	230	15
B7540	380	365	230	15
B9040	380	540	230	25
B10040	380	540	230	25
B12540	380	540	230	30
B15040	770	520	320	50
B17540	770	520	320	55

### H type - Three-phase

Cat.Nos	Dimensions (mm)			Weight (kg)
	Height	Width	Depth	
BH1040	380	190	230	5
BH1540	380	190	230	5
BH2040	380	190	230	5
BH2540	380	190	230	7.5
BH3040	380	190	230	10
BH4040	380	365	230	10
BH5040	380	365	230	12.5
BH6040	380	365	230	15
BH7540	380	365	230	15
BH9040	380	540	230	25
BH10040	380	540	230	25
BH12540	380	540	230	30
BH15040	770	520	320	50
BH17540	770	520	320	55



# Racks Alpimatic

400 V network



P7540

Factory connected units for integration in universal cabinets for automatic compensation systems

Standard and H versions:

- 1 Alpvivar<sup>2</sup> capacitor
- 1 contactor suitable for the capacitive currents
- 1 set of 3 HRC fuses
- 1 set of modular copper busbars with junction bars for connecting several racks
- 1 steel frame on which the components are assembled and wired

Pack	Cat.Nos	<b>Standard type three-phase 400 V - 50 Hz</b>
		<b>470 V max.</b>
		Harmonic pollution SH/ST ≤ 15%
		Nominal power (kVAr)
1	P12.540	12.5
1	P12.512.540	12.5+12.5
1	P2540	25
1	P252540	25+25
1	P255040	25+50
1	P5040	50
1	P7540	75

Pack	Cat.Nos	<b>H type three-phase 400 V - 50 Hz</b>
		<b>520 V max.</b>
		Harmonic pollution 15% < SH/ST ≤ 25%
		Nominal power (kVAr)
1	PH12.540	12.5
1	PH12.512.540	12.5+12.5
1	PH2540	25
1	PH252540	25+25
1	PH255040	25+50
1	PH5040	50
1	PH7540	75

# Racks Alpimatic

## Technical specifications

### Loss factor

Standard and H type Alpimatic racks have a loss factor of 2 W/kVAr, while that of SAH type racks is 6 W/kVAr

### Standards

- International standard: IEC 61433-1
- European standard: EN 61439-1
- French standard: NF EN 61439-1

### Temperature class

- Operation: -10 to +45°C (average over 24 hours: 40°C)
- Storage: -30 to +60°C

## Dimensions

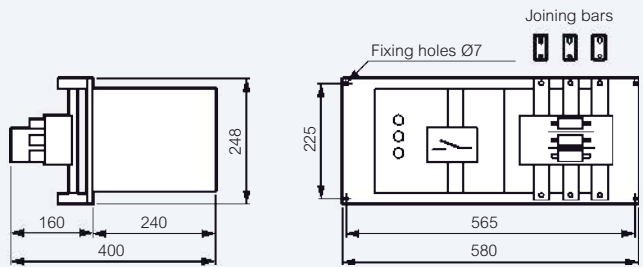

### Standard type

	Weight (kg)
P12.540	6
P12.512.540	11
P2540	9
P252540	16
P255040	22
P5040	16
P7540	22

### H type

	Weight (kg)
PH12.540	7
PH12.512.540	14
PH2540	10
PH252540	17
PH255040	23
PH5040	17
PH7540	23

# Racks Alpimatic with detuned reactors

400 V network

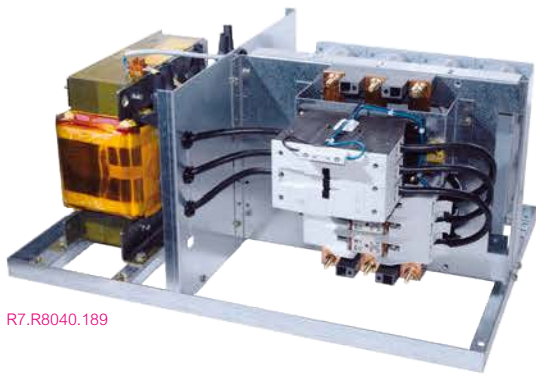









R7.R8040.189

Factory connected units for integration in universal cabinets for automatic compensation systems

SAH versions (detuned reactors):

- 1 Alpivar<sup>2</sup> capacitor
- 1 contactor suitable for the capacitive currents
- 1 detuned reactor with thermal protection
- 1 set of 3 HRC fuses
- 1 set of modular copper busbars with junction bars for connecting several racks
- 1 steel frame on which the components are assembled and wired

Pack	Cat.Nos	SAH type three-phase 400 V - 50 Hz
		<b>Standard class - Max. 470 V</b>
		Harmonic pollution 25% < SH/ST ≤ 35%
		Nominal power (kVAr)
1	 R5.2540.189	25
1	 R5.5040.189	50
1	 R7.5040.189	50
1	 R7.7540.189	75
		<b>Reinforced class - Max. 520 V</b>
		Harmonic pollution 35% < SH/ST ≤ 50%
		Nominal power (kVAr)
1	 R5.R4040.189	40
1	 R7.R4040.189	40
1	 R7.R8040.189	80
		<b>Extra-reinforced class - Max. 620 V</b>
		Harmonic pollution SH/ST > 50%
		Nominal power (kVAr)
1	 R9.RS7240.189	72

# Racks Alpimatic with detuned reactors

## Dimensions

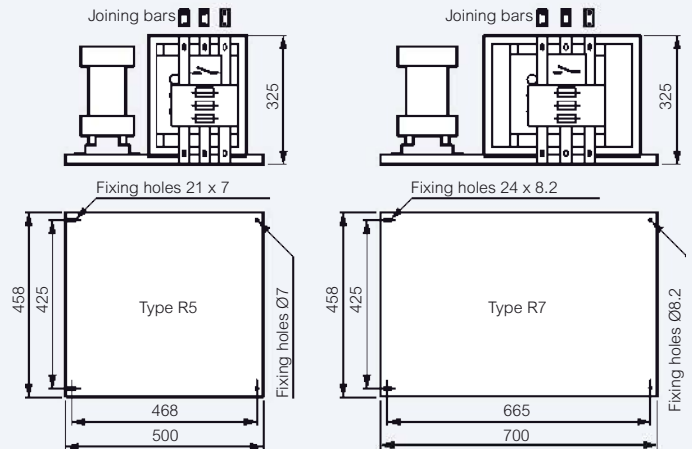

## Standard class

	Weight (kg)
R5.2540.189	45
R5.5040.189	50
R7.5040.189	55
R7.7540.189	60

## Reinforced class

	Weight (kg)
R5.R4040.189	50
R7.R4040.189	52
R7.R8040.189	65

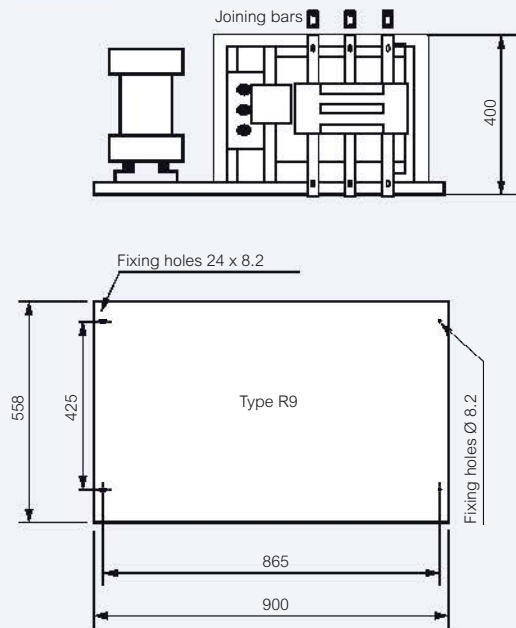

## Extra-reinforced class

	Weight (kg)
R9.RS7240.189	80



# Automatic capacitor banks Alpimatic

400 V network



M6040



M20040

Dimensions p. 102

IP 31 - IK 05 cabinet

Fully modular design for easy extension and maintenance

Alpimatic is made up of one or several cabinets according to the capacitor bank model and the nominal current

The electromechanical contactors are controlled by the Alptec power controller with a simple commissioning procedure

Cable entry at the bottom (at the top on request)

Electrical parts protected against direct contact: IP 2 X (door open)

Grey cabinet (RAL 7035) with black base Conforming to standards IEC 60439-1 and 2 and EN 60439-1

Pack	Cat.Nos	Standard type three-phase 400 V - 50 Hz	
		<b>470 V max.</b>	
		Harmonic pollution SH/ST ≤ 15%	
		Nominal power (kVAr)	Steps (kVAr)
1	M1040	10	2x2.5+5
1	M1540	15	2.5+5+7.5
1	M2040	20	2.5+5+12.5
1	M2540	25	5+10+10
1	M3040	30	5+10+15
1	M3540	35	5+10+20
1	M4040	40	5+10+25
1	M5040	50	10+15+25
1	M52.540	52.5	7.5+15+30
1	M6040	60	10+25+25
1	M67.540	67.5	7.5+15+2x22.5
1	M7540	75	7.5+15+22.5+30
1	M87.540	87.5	12.5+3x25
1	M10040	100	12.5+2x25+37.5
1	M112.540	112.5	12.5+2x25+50
1	M12540	125	25+2x50
1	M15040	150	25+50+75
1	M17540	175	2x25+50+75
1	M20040	200	50+2x75
1	M22540	225	25+50+2x75
1	M25040	250	2x50+2x75
1	M27540	275	25+2x50+2x75
1	M30040	300	25+50+3x75
1	M35040	350	50+4x75
1	M40040	400	2x50+4x75
1	M45040	450	6x75
1	M50040	500	50+6x75
1	M55040	550	2x50+6x75
1	M60040	600	8x75
1	M67540	675	9x75
1	M75040	750	10x75
1	M82540	825	11x75
1	M90040	900	12x75

Pack	Cat.Nos	H type three-phase 400 V - 50 Hz	
		<b>520 V max.</b>	
		Harmonic pollution 15% < SH/ST ≤ 25%	
		Nominal power (kVAr)	Steps (kVAr)
1	MH1040	10	2x2.5+5
1	MH1540	15	2.5+5+7.5
1	MH2040	20	2.5+5+12.5
1	MH2540	25	5+10+10
1	MH3040	30	5+10+15
1	MH3540	35	5+10+20
1	MH4040	40	5+10+25
1	MH5040	50	10+15+25
1	MH52.540	52.5	7.5+15+2+22.5
1	MH6040	60	10+25+25
1	MH67.540	67.5	7.5+15+2+22.5
1	MH7540	75	7.5+15+22.5+30
1	MH87.540	87.5	12.5+3x25
1	MH10040	100	12.5+2x25+37.5
1	MH112.540	112.5	12.5+2x25+50
1	MH12540	125	25+2x50
1	MH15040	150	25+50+75
1	MH17540	175	2x25+50+75
1	MH20040	200	50+2x75
1	MH22540	225	25+50+2x75
1	MH25040	250	2x50+2x75
1	MH27540	275	25+2x50+2x75
1	MH30040	300	25+50+3x75
1	MH35040	350	50+4x75
1	MH40040	400	2x50+4x75
1	MH45040	450	6x75
1	MH50040	500	50+6x75
1	MH55040	550	2x50+6x75
1	MH60040	600	8x75
1	MH67540	675	9x75
1	MH75040	750	10x75
1	MH82540	825	11x75
1	MH90040	900	12x75

Other powers, voltages, frequencies on request  
**Please, consult us**

# Automatic capacitor banks Alpimatic

400 V network (continued)

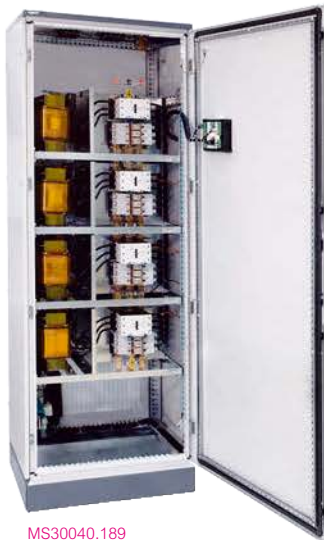

MS30040.189



MS.R40040.189

 Dimensions p. 102

IP 31 - IK 05 cabinet

Fully modular design for easy extension and maintenance

Alpimatic is made up of one or several cabinets according to the capacitor bank model and the nominal current

The electromechanical contactors are controlled by the Alptec power controller with a simple commissioning procedure

Cable entry at the bottom (at the top on request)

Electrical parts protected against direct contact: IP 2 X (door open)

Grey cabinet (RAL 7035) with black base Conforming to standards IEC 60439-1 and 2 and EN 60439-1

Pack	Cat.Nos	<b>SAH type three-phase 400 V - 50 Hz</b>	
<b>Standard class - Max. 470 V</b>			
Harmonic pollution 25% < SH/ST ≤ 35%			
		Nominal power (kVAr)	Steps (kVAr)
1	MS7540.189	75	25+50
1	MS10040.189	100	2x25+50
1	MS12540.189	125	25+2x50
1	MS15040.189	150	3x50
1	MS20040.189	200	50+2x75
1	MS22540.189	225	3x75
1	MS25040.189	250	2x50+2x75
1	MS27540.189	275	50+3x75
1	MS30040.189	300	4x75
1	MS35040.189	350	50+4x75
1	MS37540.189	375	5x75
1	MS45040.189	450	6x75
1	MS52540.189	525	7x75
1	MS60040.189	600	8x75
1	MS67540.189	675	9x75
1	MS75040.189	750	10x75

Pack	Cat.Nos	<b>SAH type three-phase 400 V - 50 Hz (continued)</b>	
<b>Reinforced class - Max. 520 V</b>			
Harmonic pollution 35% < SH/ST ≤ 50%			
		Nominal power (kVAr)	Steps (kVAr)
1	MS.R12040.189	120	3x40
1	MS.R16040.189	160	2x40+80
1	MS.R20040.189	200	40+2x80
1	MS.R24040.189	240	2x40+2x80
1	MS.R28040.189	280	40+3x80
1	MS.R32040.189	320	4x80
1	MS.R36040.189	360	40+4x80
1	MS.R40040.189	400	5x80
1	MS.R44040.189	440	40+5x80
1	MS.R48040.189	480	6x80
1	MS.R52040.189	520	40+6x80
1	MS.R56040.189	560	7x80
1	MS.R60040.189	600	40+7x80
1	MS.R64040.189	640	8x80
1	MS.R72040.189	720	9x80
1	MS.R80040.189	800	10x80

 Other powers, voltages, frequencies on request  
**Please, consult us**

# Automatic capacitor banks Alpimatic

400 V network

## ■ Dimensions

### Standard type - Three-phase

Cat.Nos	Dimensions (mm)			Weight (kg)
	Height	Width	Depth	
M1040	770	260	320	30
M1540	770	260	320	30
M2040	770	260	320	30
M2540	770	260	320	30
M3040	770	260	320	30
M3540	770	260	320	30
M4040	770	260	320	30
M5040	770	260	320	30
M52.540	770	260	320	30
M6040	770	260	320	30
M67.540	770	520	320	40
M7540	770	520	320	45
M87.540	770	520	320	45
M10040	770	520	320	45
M112.540	770	520	320	50
M12540	770	520	320	50
M15040	770	520	320	50
M17540	1400	600	500	110
M20040	1400	600	500	110
M22540	1400	600	500	120
M25040	1400	600	500	120
M27540	1400	600	500	125
M30040	1400	600	500	130
M35040	1900	600	500	165
M40040	1900	600	500	175
M45040	1900	600	500	190
M50040	1400	1200	500	230
M55040	1400	1200	500	245
M60040	1400	1200	500	250
M67540	1900	1200	500	315
M75040	1900	1200	500	330
M82540	1900	1200	500	360
M90040	1900	1200	500	390

### H type - Three-phase

Cat.Nos	Dimensions (mm)			Weight (kg)
	Height	Width	Depth	
MH1040	770	260	320	30
MH1540	770	260	320	30
MH2040	770	260	320	30
MH2540	770	260	320	30
MH3040	770	260	320	30
MH3540	770	260	320	30
MH4040	770	260	320	30
MH5040	770	260	320	30
MH52.540	770	260	320	30
MH6040	770	260	320	30
MH67.540	770	520	320	40
MH7540	770	520	320	45
MH87.540	770	520	320	45
MH10040	770	520	320	45
MH112.540	770	520	320	50
MH12540	770	520	320	50
MH15040	770	520	320	50
MH17540	1400	600	500	110
MH20040	1400	600	500	110
MH22540	1400	600	500	120
MH25040	1400	600	500	120
MH27540	1400	600	500	125
MH30040	1400	600	500	130
MH35040	1900	600	500	165
MH40040	1900	600	500	175
MH45040	1900	600	500	190
MH50040	1400	1200	500	230
MH55040	1400	1200	500	245
MH60040	1400	1200	500	250
MH67540	1900	1200	500	315
MH75040	1900	1200	500	330
MH82540	1900	1200	500	360
MH 90040	1900	1200	500	390

## ■ Dimensions

### SAH type standard class - Three-phase

Cat.Nos	Dimensions (mm)			Weight (kg)
	Height	Width	Depth	
MS7540.189	1400	600	500	150
MS10040.189	1400	600	500	155
MS12540.189	1400	600	500	175
MS15040.189	1400	600	500	180
MS20040.189	1900	800	500	270
MS22540.189	1900	800	500	275
MS25040.189	1900	800	500	280
MS27540.189	1900	800	500	320
MS30040.189	1900	800	500	325
MS35040.189	2100	800	500	390
MS37540.189	2100	800	500	400
MS45040.189	1900	1600	500	550
MS52540.189	1900	1600	500	610
MS60040.189	1900	1600	500	670
MS67540.189	2100	1600	500	730
MS75040.189	2100	1600	500	790

### SAH type reinforced class - Three-phase

Cat.Nos	Dimensions (mm)			Weight (kg)
	Height	Width	Depth	
MS.R12040.189	1400	600	500	200
MS.R16040.189	1900	800	500	275
MS.R20040.189	1900	800	500	335
MS.R24040.189	1900	800	500	350
MS.R28040.189	1900	800	500	410
MS.R32040.189	1900	800	500	440
MS.R36040.189	2100	800	500	505
MS.R40040.189	2100	800	500	535
MS.R44040.189	1900	1600	500	570
MS.R48040.189	1900	1600	500	600
MS.R52040.189	1900	1600	500	630
MS.R56040.189	1900	1600	500	660
MS.R60040.189	1900	1600	500	690
MS.R64040.189	1900	1600	500	720
MS.R72040.189	2100	1600	500	840
MS.R80040.189	2100	1600	500	900





ALPTEC6

The Alptec power factor controller controls the connection and disconnection of the steps in order to maintain the target power factor. Digital operation ensures the accuracy and reliability of the measurements and values read, even on supplies subject to high levels of interference. Conforming to standards IEC/EN 55022, IEC/EN 61000-4-2, IEC/EN 61000-4-3, IEC/EN 61000-4-4, IEC/EN 61000-4-5, IEC/EN 61000-4-6, IEC/EN 61000-4-11.

Pack	Cat.Nos	Power factor controllers
		Power supply 230-415 V $\sim$ - 50/60 Hz
		Number of steps controlled
1	ALPTEC4	4
1	ALPTEC6	6
1	ALPTEC12B	12

### Technical specifications

#### Versions

- Digital power factor controller
- Flush-mounting
- LED screen: 3 digits, 7 segments
- 4, 6 and 12 controlled steps
- IP 41 front cover / IP 20 terminal block connections
- Relative humidity without condensation: 95 %
- RJ 11 connector
- TTL standard serial interface
- Owner / ModBus RTU communication protocol

#### Measurements

- Cos  $\Phi$  inductive and capacitive
- Phase to phase voltage and currents
- Reactive power needed
- Cos  $\Phi$  desired
- Total harmonic distortion
- Sensitivity
- Ambient temperature
- Measuring values: True real effective values (TRMS)

#### Temperature class

- Operation: - 10 to + 50 °C
- Storage: - 30 to + 70 °C

#### Electrical characteristics

- Supply voltage: 230 to 415 VAC
- Operating limits (Ue): - 15 to + 10 %
- Power consumption L/L - 400 VAC:
  - 5.8 VA (for Alptec4 and Alptec6)
  - 6.1 VA (for Alptec12B)
- Immunity time for microbreakings: <6 ms
- Rated current (CT): 5 A
- Rated reading limits (CT): 0.125 A to 5.5 A
- Voltage current limits (Lx/Lx):
  - 180 to 485 VAC (for Alptec4 and Alptec6)
  - 195 to 460 VAC (for Alptec12B)
- Electrical insulation: 4 kV
- FFT - Harmonic spectrum (THD %): 64 st

#### Frequency

50 Hz/60 Hz

#### Parameters

Power factor: 0.85 inductive to 0.95 capacitive  
 Autorecognized capacitor bank  
 Anti-hunting function  
 Fixed step programmable  
 Function and alarm relay programmable  
 Fan relay programmable

Cat.Nos	Height x Width x Depth (mm)	Weight (g)
ALPTEC4	96 x 96 x 74	350
ALPTEC6	96 x 96 x 74	370
ALPTEC12B	149 x 149 x 60	700

#### ALPTEC4 / ALPTEC6

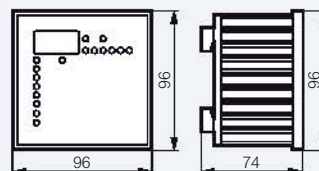

#### ALPTEC12B

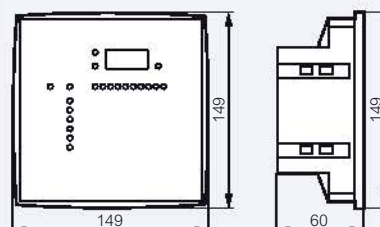

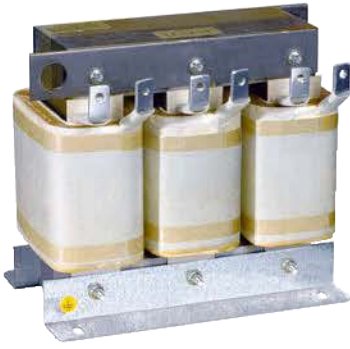

SAH-3.45-20.2

The Alptec detuned reactors are designed to protect the capacitors against harmonics and avoid parallel resonance and amplification of harmonics flowing on the network

The connection of these reactors in series with capacitors causes a shift of the resonance frequency of the circuit composed by feeding transformer-reactors- capacitors so that the resulting self-resonance frequency is well below the line harmonics

The blocking factor  $p\%$  is expressed by the ratio between inductive reactance and capacitive reactance it corresponds to the increase of voltage applied to capacitors, with respect to line voltage, due to circulation of capacitive current in the reactor  
Conforming to standards IEC/EN 60289

**Detuned reactors three-phase 50 Hz**

Pack	Cat.Nos	Q (kVar)	Associated capacitor
1	SAH-4.31-16.2	10	4 151 82/90
1	SAH-3.45-20.2	12.5	4 151 83/91
1	SAH-1.73-40.4	25	4 151 86/94
1	SAH-0.86-80.8	50	2 x 4 151 86/94
1	SAH-0.58-121.2	75	3 x 4 151 86/94
1	SAH-0.43-161.6	100	4 x 4 151 86/94

**Tuning frequency 189 Hz**

$P\% = 7 / n = 3.78$   
Designed for harmonic level  
 $25\% < SH/ST^{(1)} < 50\%$   
To be associated with 440 V / 480 V capacitors

**Tuning frequency 135 Hz**

$P\% = 14 / n = 2.7$   
Designed for harmonic level  
 $25\% < SH/ST^{(1)} < 50\%$   
To be associated with 480 V capacitors

Pack	Cat.Nos	Q (kVar)	Associated capacitor
1	SAH-8.1-15.7	12.5	4 151 90
1	SAH-4.05-28.9	25	4 151 93
1	SAH-2.02-62.8	50	2 x 4 151 93
1	SAH-1.35-94.2	75	3 x 4 151 93
1	SAH-1-125.6	100	4 x 4 151 93

1: SH = Power (kW) of loads generating harmonics  
ST = Power (kVA) of transformer

**Technical specifications**

- Rated line voltage: 400 V / 440 V
- Rated frequency: 50 Hz
- Tolerance on inductance: 0 / + 6 %
- Dielectric test 50 Hz, 3 kV, 60 s, protection class: IP 00
- Cooling method: natural air (AN)
- Ambient temperature: - 5 to + 40 °C
- Elevation above sea level: 1000 m a.s.l
- Conform to: IEC 60289 - EN 602 89
- Insulation class H
- Insulation level 1.1 kV
- Blocking factor  $p\% = 7$  - Tuning order = 3.78 /  $p\% = 13.7$  - Tuning order = 2.7
- Thermal protection switch (250 V, 2.5 A) wired on terminal block

**Installation and requirements**

- Operation and storage temperature: - 25 to + 70 °C
- Selection of the right type according to harmonic pollution
- In operation an adequate air circulation must be guaranteed
- Windings must be installed vertically for better heat dissipation
- The reactor must be protected against overloads and short-circuits by fuses and/or circuit breakers
- Suitable protection against undesired contacts (IP00) must be provided by means of enclosures or boxes protecting the power system where the reactor is installed
- It is imperative that the thermal N.C dry contact be connected in series with the contactor coil, in order to disconnect the step in case of overheating

**Dimensions**

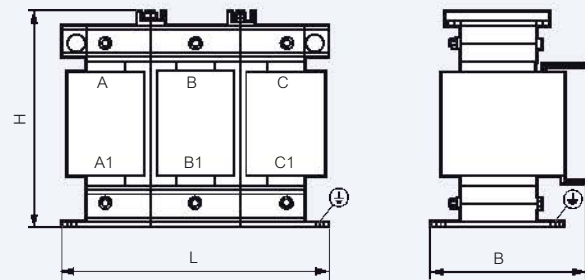

Aluminium bars

Cat.Nos	Q (kVar)	Ln (mH)	I RMS (A)	Ptot (W)	Dimensions (mm)			Weight (kg)
					L	W	H	
SAH-4.31-16.2	10	4.31	16.2	85	180	140	190	11
SAH-3.45-20.2	12.5	3.45	20.2	105	180	140	190	11
SAH-1.73-40.4	25	1.73	40.4	210	240	140	255	17
SAH-0.86-80.8	50	0.86	80.8	270	240	165	280	28
SAH-0.58-121.2	75	0.58	121.2	400	300	190	315	40
SAH-0.43-161.6	100	0.43	161.6	425	320	210	315	50
SAH-8.1-15.7	12.5	8.1	15.7	130	240	140	220	14.5
SAH-4.05-28.9	25	4.05	28.9	225	240	160	240	22
SAH-2.02-62.8	50	2.02	62.8	395	300	180	315	38
SAH-1.35-94.2	75	1.35	94.2	475	320	210	325	51
SAH-1-125.6	100	1	125.6	615	360	210	375	65



# DRX

now up to 630 A

### THREE SIZES OF MCCBs, 3-POLE AND 4-POLE

The new DRX 630 MCCBs enhance the DRX range to fit to installations up to 630 A.



DRX 125 from 15 to 125 A mounting on rail or on plate

DRX 250 from 125 to 250 A mounting on rail or on plate

**NEW** DRX 630 from 320 to 630 A mounting on plate

### BREAKING CAPACITIES FROM 10 TO 50 kA

The wide range of breaking capacities allows the use of DRX of all levels of the installations.

	10 kA	18 kA	20 kA	25 kA	36 kA	50 kA
DRX 125	•		•		•	
DRX 250		•		•	•	
DRX 630					•	•

- Easy mounting control and signalling auxiliaries common for DRX 125 and DRX 250 and specific for DRX 630.

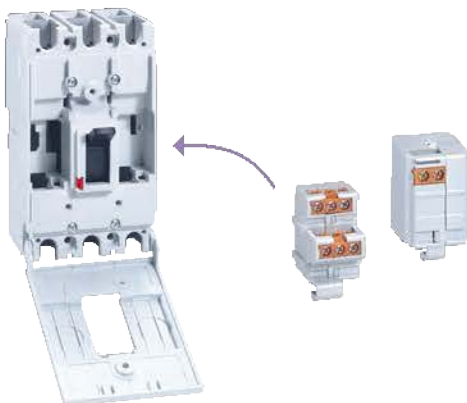

- A complete range of accessories : rotary handles, insulating shields, connection accessories, locking accessories...



# DRX™ 125

thermal magnetic MCCBs from 15 to 125 A



Technical characteristics and curves p. 107 to 109

For switching, control, isolation and protection of low-voltage electrical lines  
Can be fitted with auxiliaries (p. 110)

Supplied with:

- M5 terminal for  $I_n \leq 50$  A and M8 range for  $I_n > 50$  A
- Fixing screws
- Insulating shields (2 for 3P and 3 for 4P)

Fixed thermal and magnetic

Conform to IEC 60947-2, in compliance with NEMA

Pack	Cat.Nos		DRX 125
			<b>Breaking capacity Icu 10 kA (415 V~)</b>
	3P	4P	$I_n$
1	0 270 00	0 270 10	15 A
1	0 270 01	0 270 11	20 A
1	0 270 02	0 270 12	25 A
1	0 270 03	0 270 13	30 A
1	0 270 04	0 270 14	40 A
1	0 270 05	0 270 15	50 A
1	0 270 06	0 270 16	60 A
1	0 270 39	0 270 29	63 A
1	0 270 07	0 270 17	75 A
1	0 270 08	0 270 18	100 A
1	0 270 09	0 270 19	125 A
			<b>Breaking capacity Icu 20 kA (415 V~)</b>
			$I_n$
1	0 270 20	0 270 30	15 A
1	0 270 21	0 270 31	20 A
1	0 270 22	0 270 32	25 A
1	0 270 23	0 270 33	30 A
1	0 270 24	0 270 34	40 A
1	0 270 25	0 270 35	50 A
1	0 270 26	0 270 36	60 A
1	0 272 20	0 272 22	63 A
1	0 270 27	0 270 37	75 A
1	0 270 28	0 270 38	100 A
1	0 272 21	0 272 23	125 A
			<b>Breaking capacity Icu 36 kA (415 V~)</b>
	1P	2P	$I_n$
1	0 270 40 <sup>1</sup>	0 270 50	15 A
1	0 270 41 <sup>1</sup>	0 270 51	20 A
1	0 270 42 <sup>1</sup>	0 270 52	25 A
1	0 270 43 <sup>1</sup>	0 270 53	30 A
1	0 270 44 <sup>1</sup>	0 270 54	40 A
1	0 270 45 <sup>1</sup>	0 270 55	50 A
1	0 270 46 <sup>1</sup>	0 270 56	60 A
1	0 270 47 <sup>1</sup>	0 270 57	75 A
1	0 270 48 <sup>1</sup>	0 270 58	100 A
	3P	4P	$I_n$
1	0 270 60	0 270 70	15 A
1	0 270 61	0 270 71	20 A
1	0 270 62	0 270 72	25 A
1	0 270 63	0 270 73	30 A
1	0 270 64	0 270 74	40 A
1	0 270 65	0 270 75	50 A
1	0 270 66	0 270 76	60 A
1	0 272 24	0 272 26	63 A
1	0 270 67	0 270 77	75 A
1	0 270 68	0 270 78	100 A
1	0 272 25	0 272 27	125 A

Pack	Cat.Nos	Mounting on rail
20	0 271 89	Plates for fixing DRX 125 on DIN rail
12	0 271 90	For 1P
6	0 271 87	For 2P For 3P and 4P
		<b>Rotary handles</b>
1	0 271 76	<b>Direct on DRX</b> Standard (grey)
1	0 271 77	<b>Vari-depth handle</b> Comprising: connecting rod, bracket, drilling template, mounting accessories, door locking mechanism Standard (grey)
		<b>Connection accessories</b>
		<b>Insulating shields</b> Used to isolate the connection between each pole
1	0 271 81	Set of 2
1	0 271 82	Set of 3
		<b>Sealable terminal shields</b>
1	0 271 91	Set of 2
		<b>Cage terminals</b>
1	0 271 70	Up to 50 A (inclusive)
1	0 271 71	From 60 to 100 A
1	0 272 52	For 125 A
1	0 271 92	Set of 60 pieces up to 50 A (inclusive)
1	0 271 93	Set of 60 pieces from 60 to 100 A
1	0 272 54	Set of 60 pieces 125 A
		<b>Padlock for DRX 125 and 250</b>
1	0 271 80	For locking on "OFF" position (up to 3 locks)

1: Icu 25 kA (240 V~) for 1P

# DRX™ 125

## technical characteristics and curves

### Curves

**DRX 125**  $I_{max} = 125\text{ A}$  from 10 kA to 36 kA 3P - 4P at 415 V~

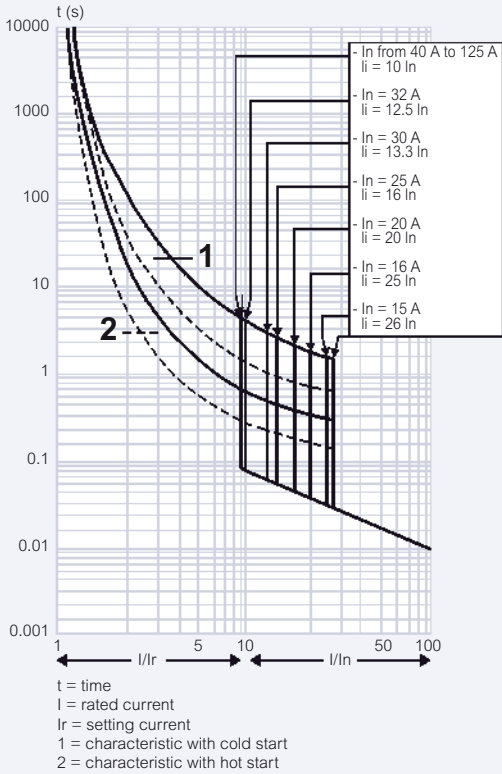

### Pass-through specific energy characteristics

**DRX 125**  $I_{max} = 125\text{ A}$  from 10 kA to 36 kA 3P - 4P at 415 V~

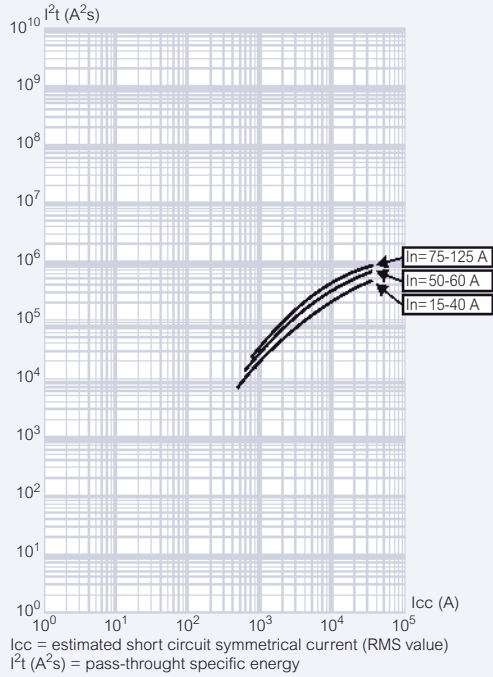

### Current limitation

**DRX 125**  $I_{max} = 125\text{ A}$  from 10 kA to 36 kA 3P - 4P at 415 V~

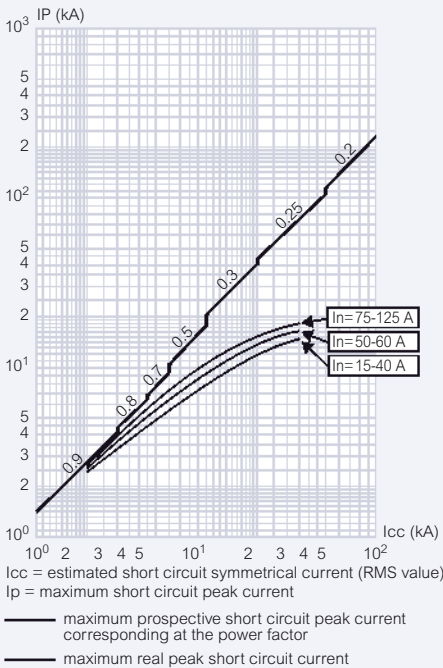

### Technical characteristics

	DRX 10 kA	DRX 20 kA	DRX 36 kA <sup>(1)</sup>	DRX 36 kA	DRX 36 kA
<b>Number of poles</b>	3P - 4P	3P - 4P	1P	2P	3P - 4P
<b>Nominal current <math>I_n</math> (A)</b>	15-125	15-125	15-100	15-100	15-125
<b>Neutral protection for 4P version (%)</b>	100	100	100	100	100
<b>Rated insulation voltage <math>U_i</math> (V)</b>	690	690	690	690	690
<b>Rated impulse withstand current <math>I_{imp}</math> (kV)</b>	6	6	6	6	6
<b>Rated operating voltage (50/60 Hz) <math>U_e</math> (V)</b>	550	550	550	550	550
<b>Ultimate breaking capacity <math>I_{cu}</math> (kA) IEC 60947-2</b>	110/130 V~	50	75	50	75
	220/240 V~	25	40	25	60
	277 V~	-	-	15	50
	380/415 V~	10	20	10	36
	440/460 V~	10	15	-	30
<b>Ultimate breaking capacity <math>I_{cu}</math> (kA) NEMA AB-1</b>	480/550 V~	7,5	10	-	20
	600 V~	5	5	-	10
	125 V=	10 <sup>(2)</sup>	10 <sup>(2)</sup>	10	20 <sup>(2)</sup>
	250 V=	5 <sup>(2)</sup>	5 <sup>(2)</sup>	5	10 <sup>(2)</sup>
	240 V~	25	40	25	100
<b>Standard breaking capacity <math>I_{cs}</math> (% <math>I_{cu}</math>)</b>	480 V~	7,5	10	-	20
	600 V~	5	5	-	10
<b>Category of use</b>	A	A	A	A	A
<b>Suitable for isolation</b>	YES	YES	YES	YES	YES
<b>Endurance (cycles)</b>	<b>mechanical</b>	25000	25000	25000	25000
	<b>electrical at <math>I_n</math></b>	8000	8000	8000	8000
	<b>electrical at 0.5 <math>I_n</math></b>	10000	10000	10000	10000

1: 1P -  $I_{cu}$  25 kA (220/240 V~)  
 2: 2 poles in series

### 2 poles in series

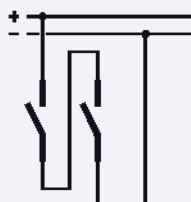

# DRX™ 125

dimensions, mounting principle and connection

## Dimensions

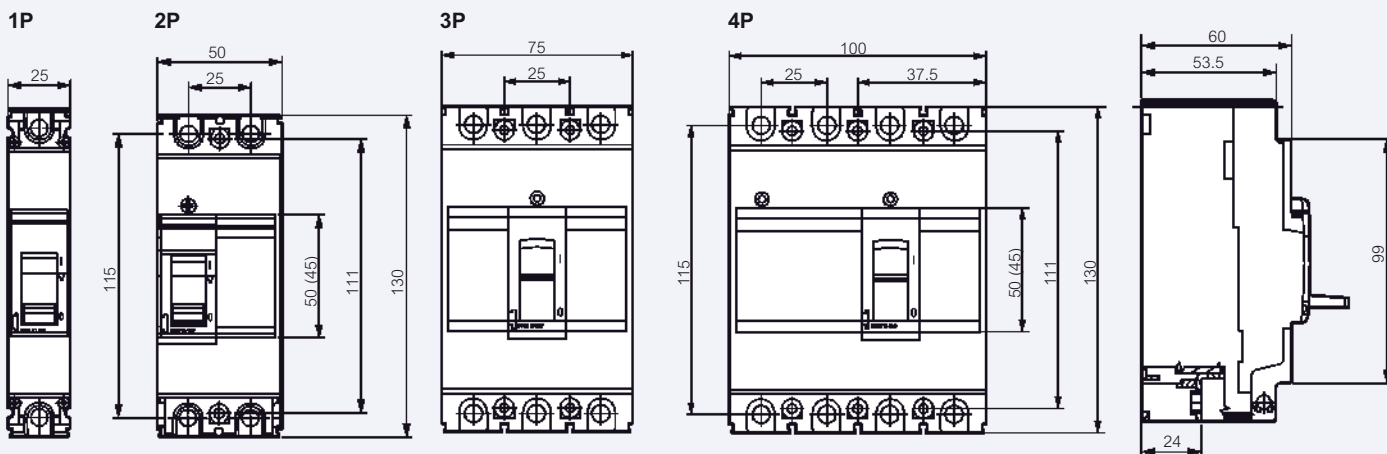

## Mounting principle

### Door cut-out

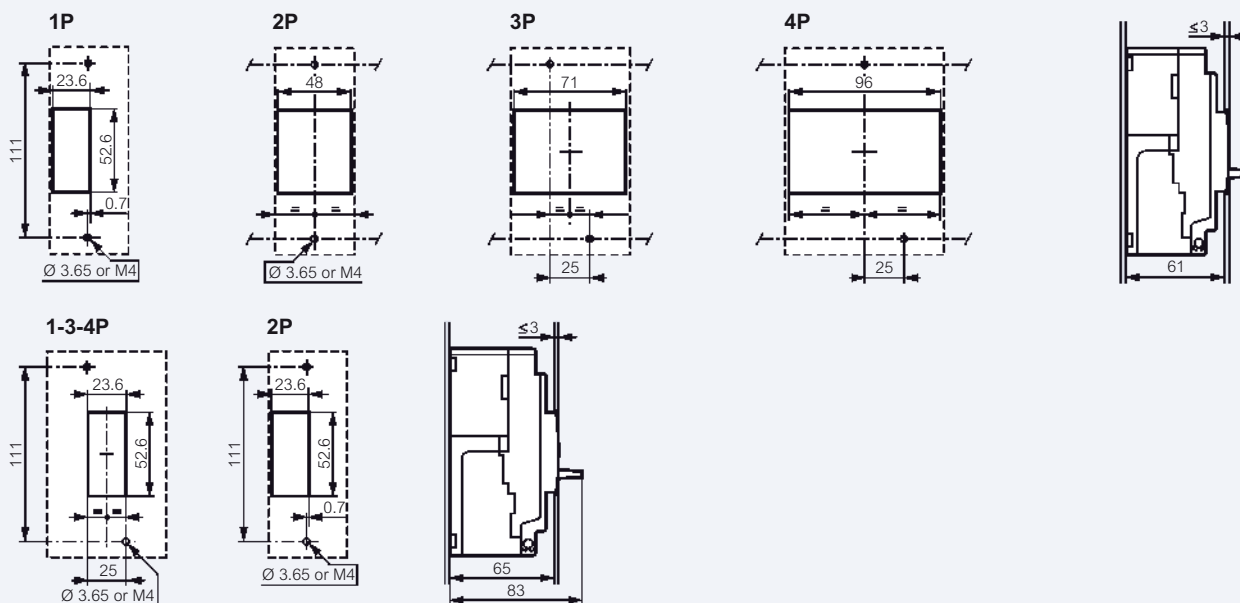

## Auxiliary contacts

	Voltage (V)	Resistive load (A)
Vac	125	5
	250	5
Vdc	30	5
	50	1
	75	0.75
	125	0.5
250	0.25	
<b>Mechanical endurance (No. of operations)</b>		5 x 10 <sup>6</sup>
<b>Temperature (°C)</b>		- 40 to 85 °C

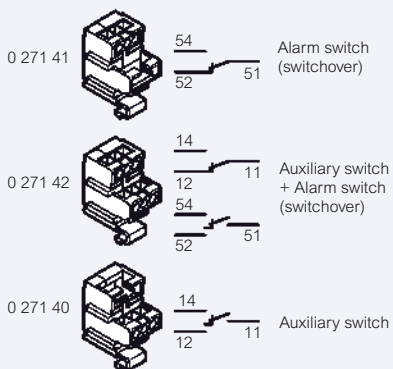

### Mounting on DIN rail with plate

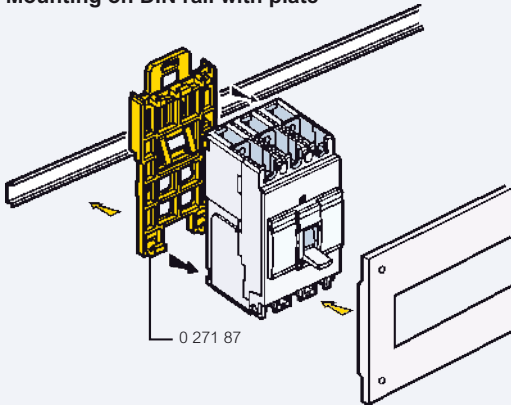

### Fixing on plate

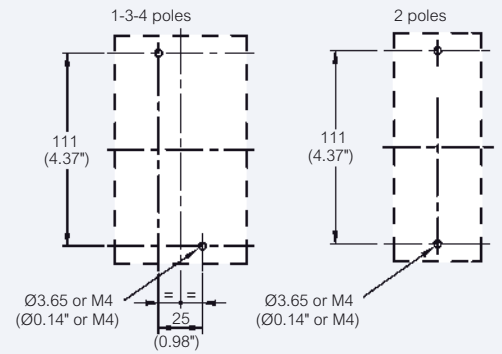
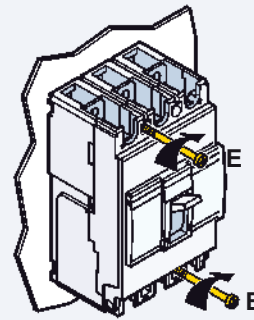

## Connection

### Connection via cable $I_n \leq 100$ A

- $I_n \leq 50$  A = 0 271 70 (3P)
- 0 271 72 (4P)
- 0 271 92 (set of 60 pieces)
- $50$  A <  $I_n \leq 100$  A = 0 271 71 (3P)
- 0 271 73 (4P)
- 0 271 93 (set of 60 pieces)

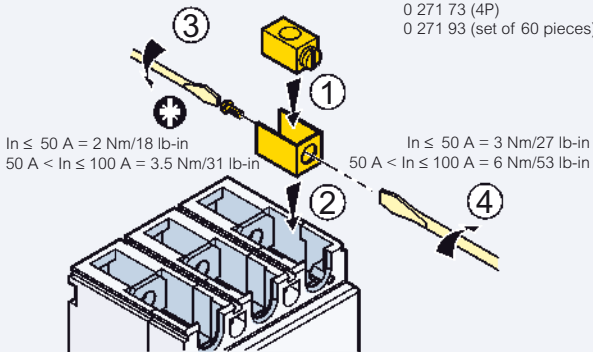

### Connection via cable $I_n = 125$ A

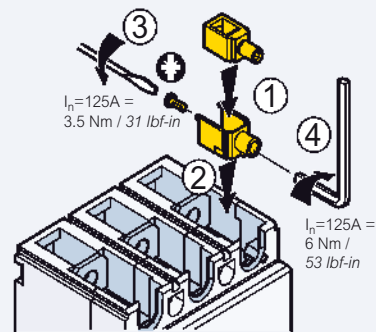

DRX ≤ 50 A	50 A < $I_n \leq 100$ A	$I_n = 125$ A
Flexible 2.5 → 10 mm <sup>2</sup> #14 → #8 AWG	Flexible 10 → 35 mm <sup>2</sup> #8 → #3/2 AWG	Flexible 35 → 50 mm <sup>2</sup> #3/2 → #1/0 AWG
or Solid 2.5 → 16 mm <sup>2</sup> #14 → #6 AWG	Solid 10 → 50 mm <sup>2</sup> #8 → #1/0 AWG	Solid 35 → 50 mm <sup>2</sup> #3/2 → #1/0 AWG

2.5 to 4 mm<sup>2</sup> (#14 to #10 AWG) flexible cables connection via crimped end-bars

### Connection via busbar

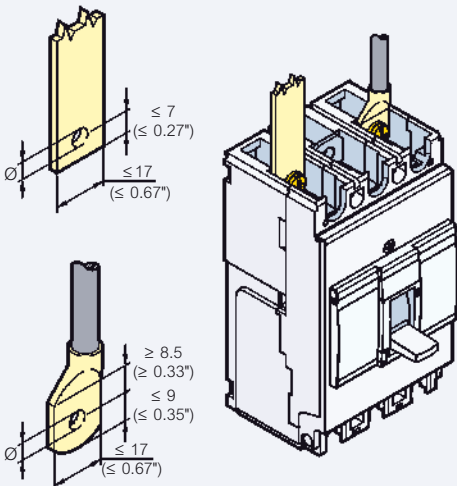

$I_n \leq 50$ A	$50$ A < $I_n \leq 125$ A
Ø 5.5 mm / 0.21"	Ø 8.5 mm / 0.32"

$I_n \leq 50$ A	$50$ A < $I_n \leq 125$ A	$I_n = 125$ A

# DRX™ 250

thermal magnetic MCCBs from 125 to 250 A

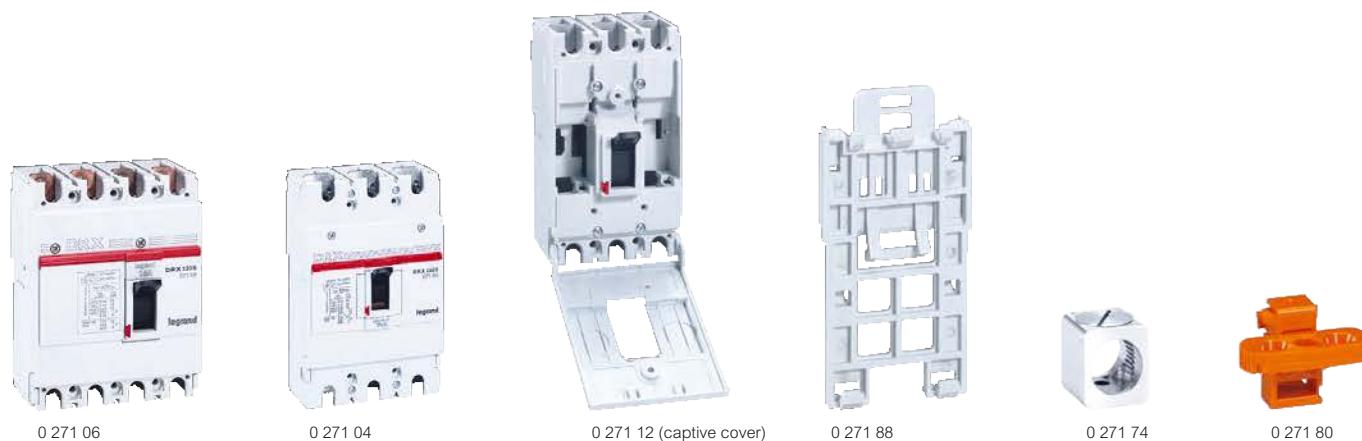

Technical characteristics and curves p. 111 to 113

For switching, control, isolation and protection of low-voltage electrical lines  
 Can be fitted with auxiliaries  
 Supplied with:  
 - M8 terminals  
 - Fixing screws  
 - Insulating shields (2 for 3P and 3 for 4P)  
 Fixed thermal and magnetic  
 Conform to IEC 60947-2

Pack	Cat.Nos		<b>DRX 250</b>
			<b>Breaking capacity Icu 18 kA (415 V~)</b>
	3P	4P	In
1	0 271 00	0 271 06	125 A
1	0 271 01	0 271 07	150 A
1	0 272 28	0 272 29	160 A
1	0 271 02	0 271 08	175 A
1	0 271 03	0 271 09	200 A
1	0 271 04	0 271 10	225 A
1	0 271 05	0 271 11	250 A
			<b>Breaking capacity Icu 25 kA (415 V~)</b>
			In
1	0 271 12	0 271 18	125 A
1	0 271 13	0 271 19	150 A
1	0 272 30	0 272 31	160 A
1	0 271 14	0 271 20	175 A
1	0 271 15	0 271 21	200 A
1	0 271 16	0 271 22	225 A
1	0 271 17	0 271 23	250 A
			<b>Breaking capacity Icu 36 kA (415 V~)</b>
			In
1	0 271 24	0 271 30	125 A
1	0 271 25	0 271 31	150 A
1	0 272 32	0 272 33	160 A
1	0 271 26	0 271 32	175 A
1	0 271 27	0 271 33	200 A
1	0 271 28	0 271 34	225 A
1	0 271 29	0 271 35	250 A
1	0 271 88		<b>Mounting on rail</b> Plate for fixing DRX 250 on DIN rail
1	0 271 78		<b>Rotary handles</b> <b>Direct on DRX</b> Standard (grey) <b>Vari-depth handle</b> Comprising: connecting rod, bracket, drilling template, mounting accessories, door locking mechanism
1	0 271 79		Standard (grey)

Pack	Cat.Nos	<b>Connection accessories</b>
		<b>Insulating shields</b> Used to isolate the connection between each pole
1	0 271 81	Set of 2
1	0 271 82	Set of 3
1	0 271 85   0 271 86	<b>Sealable terminal shields</b> Set of 2
1	0 271 74   0 271 75	<b>Cage terminals</b> Up to 250 A
1	0 271 94	Set of 60 pieces
1	0 271 80	<b>Padlock for DRX 125 and 250</b> For locking on "OFF" position (up to 3 locks)
		<b>Control and signalling auxiliaries for DRX 125 and 250</b>
		<b>Auxiliary contact blocks</b> For left-hand side mounting Up to 250 V~ and =
1	0 271 40	Block with 1 auxiliary
1	0 271 41	Block with 1 alarm
1	0 271 42	Block with 1 auxiliary + 1 alarm
		<b>Shunt trips</b>
1	0 271 50	12 V~ and =
1	0 271 51	24 V~ and =
1	0 271 52	48 V~ and =
1	0 271 53	100/130 V~
1	0 271 54	200/277 V~
1	0 271 55	380/480 V~
		<b>Undervoltage releases</b>
1	0 271 60	12 V~ and =
1	0 271 61	24 V~ and =
1	0 271 62	48 V~ and =
1	0 271 68	110 V=
1	0 271 63	110/130 V~
1	0 271 64	200/240 V~
1	0 271 67	277 V~
1	0 271 65	380/415 V~
1	0 271 66	440/480 V~



# DRX™ 250

## technical characteristics and curves

### Curves

**DRX 250**  $I_{max} = 250$  A from 18 kA to 36 kA 3P - 4P at 415 V~

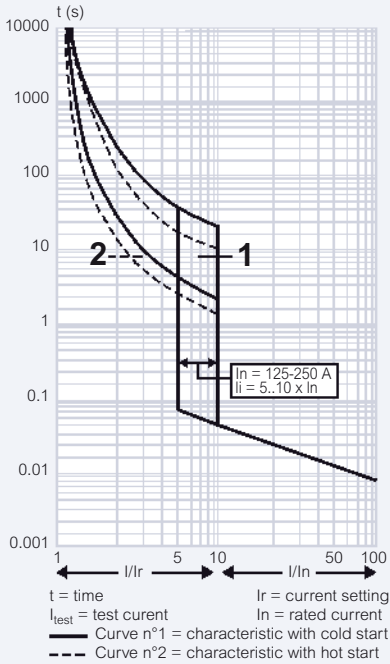

### Pass-through specific energy characteristics

**DRX 250**  $I_{max} = 250$  A from 18 kA to 36 kA 3P - 4P at 415 V~

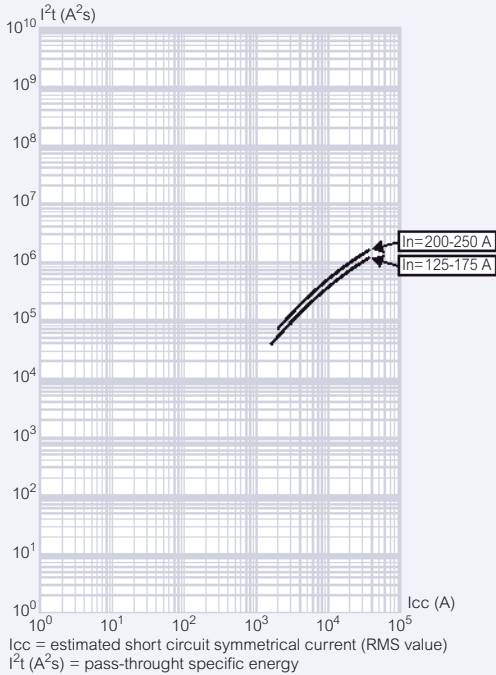

### Current limitation

**DRX 250**  $I_{max} = 250$  A from 18 kA to 36 kA 3P - 4P at 415 V~

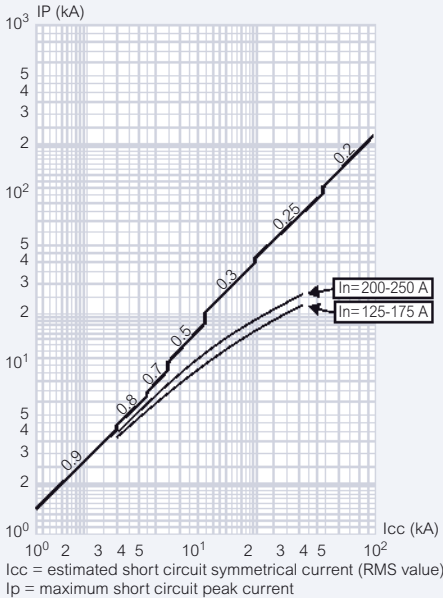

— maximum prospective short circuit peak current corresponding at the power factor  
 — maximum real peak short circuit current

### Technical characteristics

	DRX - 18 kA	DRX - 25 kA	DRX - 36 kA
<b>Number of poles</b>	3P - 4P	3P - 4P	3P - 4P
<b>Nominal current <math>I_n</math> (A)</b>	125-250	125-250	125-250
<b>Neutral protection for 4P version (%)</b>	100	100	100
<b>Rated insulation voltage <math>U_i</math> (V)</b>	690	690	690
<b>Rated impulse withstand current <math>U_{imp}</math> (kV)</b>	6	6	6
<b>Rated operating voltage (50/60 Hz) <math>U_e</math> (V)</b>	600	600	600
<b>Ultimate breaking capacity <math>I_{cu}</math> (kA) IEC 60947-2</b>	110/130 V~	35	60
	220/240 V~	35	50
	380/415 V~	18	25
	440/460 V~	15	25
	480/550 V~	10	15
<b>Ultimate breaking capacity <math>I_{cu}</math> (kA) NEMA AB-1</b>	600 V~	7,5	10
	125 V=	10 <sup>(1)</sup>	20 <sup>(1)</sup>
	250 V=	5 <sup>(1)</sup>	10 <sup>(1)</sup>
<b>Standard breaking capacity <math>I_{cs}</math> (% <math>I_{cu}</math>)</b>	50	50	50
<b>Category of use</b>	A	A	A
<b>Suitable for isolation</b>	YES	YES	YES
<b>Endurance (cycles)</b>	mechanical	25000	25000
	electrical at $I_n$	8000	8000
	electrical at 0.5 $I_n$	10000	10000

1: 2 poles in series

### 2 poles in series

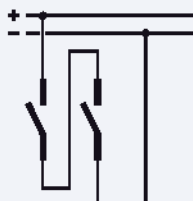

# DRX™ 250

dimensions, mounting principle and connection

## Dimensions

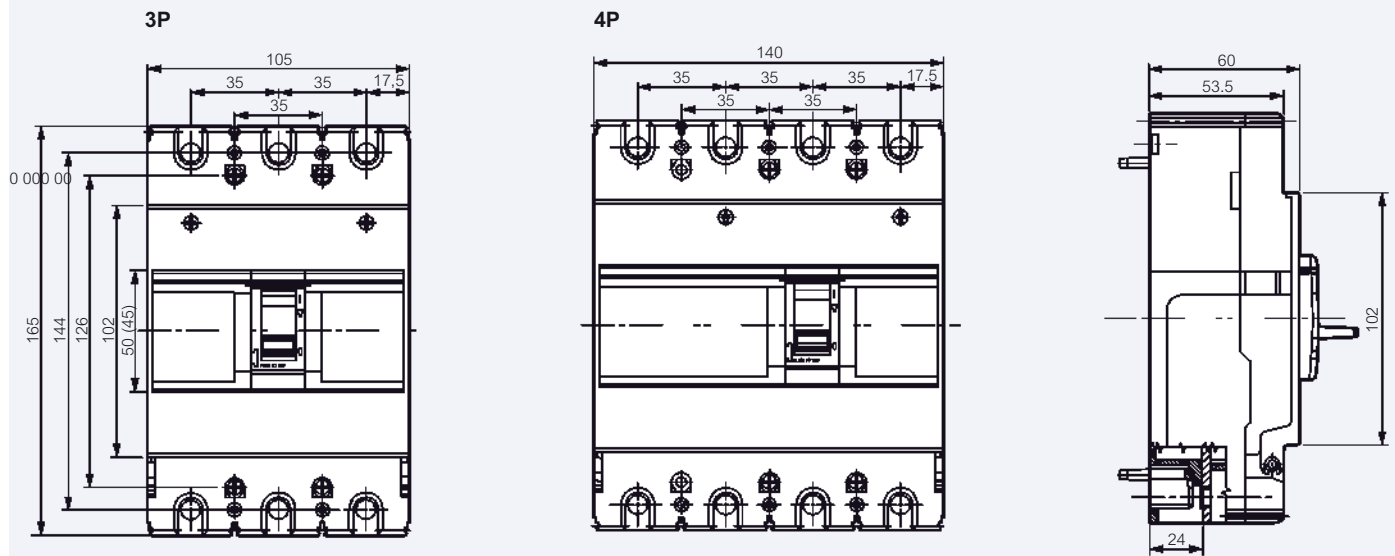

## Mounting principle

### Door cut-out

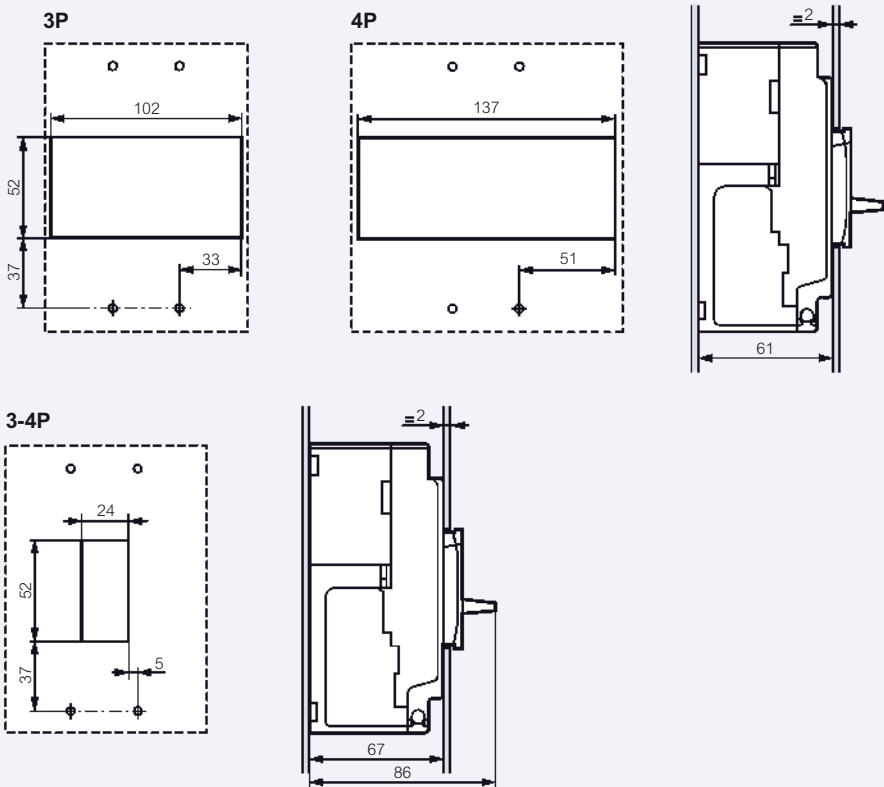

### Mounting on DIN rail with plate

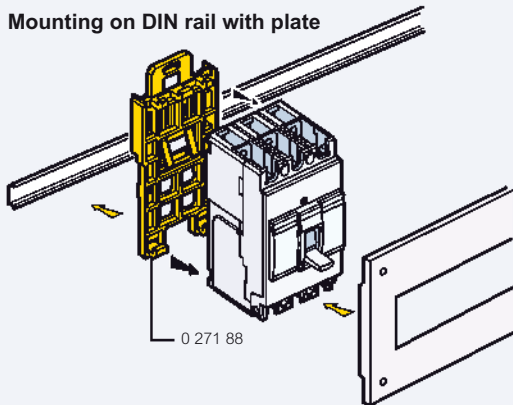

### Fixing on plate

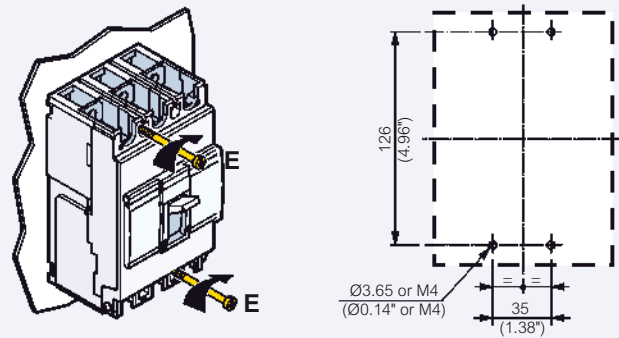

## Connection

### Connection via busbar

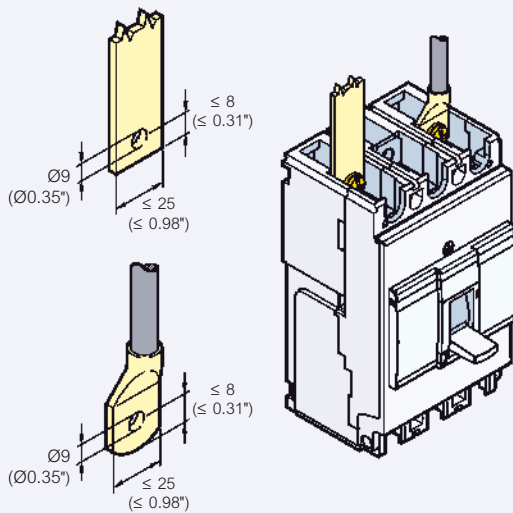

### Connection via cable

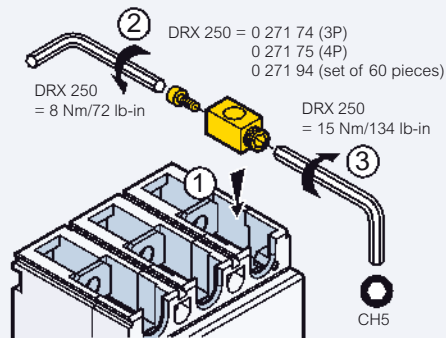

#### DRX 250 - 125 to 250 A

Flexible  
 35 mm<sup>2</sup> ⇒ 120 mm<sup>2</sup>  
 #2 ⇒ #250 MCM  
 or  
 Solid  
 35 mm<sup>2</sup> ⇒ 150 mm<sup>2</sup>  
 #2 ⇒ #300 MCM

## Auxiliary contacts

	Voltage (V)	Resistive load (A)
Vac	125	5
	250	5
Vdc	30	5
	50	1
	75	0.75
	125	0.5
	250	0.25
Mechanical endurance (No. of operations)		5 x 10 <sup>6</sup>
Temperature (°C)		- 40 to 85 °C

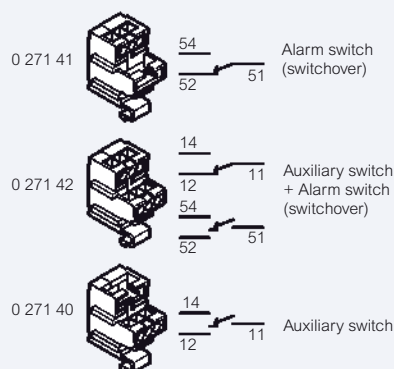



0 272 45



0 272 49



0 262 50



0 262 51



0 262 48



0 263 52

**Technical characteristics and curves p. 115 to 117**

For switching, control, isolation and protection of low-voltage electrical lines  
Can be fitted with auxiliaries

Supplied with:

- M8 terminals
- Fixing screws
- Insulating shields (2 for 3P and 3 for 4P)

Fixed thermal and magnetic

Conform to IEC 60947-2

Pack	Cat.Nos		<b>DRX 630</b>
	3P	4P	<b>Breaking capacity I<sub>cu</sub> 36 kA (415 V<sub>~</sub>)</b>
1	0 272 34	0 272 38	In
1	0 272 35	0 272 39	320 A
1	0 272 36	0 272 40	400 A
1	0 272 37	0 272 41	500 A
			<b>Breaking capacity I<sub>cu</sub> 50 kA (415 V<sub>~</sub>)</b>
1	0 272 42	0 272 46	In
1	0 272 43	0 272 47	320 A
1	0 272 44	0 272 48	400 A
1	0 272 45	0 272 49	500 A
			630 A
			<b>Rotary handles</b>
1	0 272 50		<b>Direct on DRX</b> Standard (grey)
1	0 272 51		<b>Vari-depth handle</b> Comprising: connecting rod, bracket, drilling template, mounting accessories, door locking mechanism Standard (grey)
			<b>Connection accessories</b>
1	0 262 30		<b>Insulating shields</b> Used to isolate the connection between each pole Set of 2 pieces
1	0 262 44	0 262 45	<b>Sealable terminal shields</b> Set of 2
1	4 222 34	4 222 35	<b>IP 20 terminal cover</b> Set of two terminal covers
1	0 262 50		<b>Cage terminals</b> Set of 4 cage terminals for cables
1	0 262 51		Set of 4 high capacity cage terminals for cables
1	0 262 47		<b>Extended front terminals</b> Set of 4 extended front terminals

Pack	Cat.Nos		<b>Connection accessories (continued)</b>
1	0 262 48	0 262 49	<b>3P</b>   <b>4P</b> <b>Spreaders</b> Set of incoming or outgoing spreaders
1	0 263 50	0 263 51	<b>Swivel terminals</b> Set of incoming or outgoing swivel terminals
1	0 263 52	0 263 53	<b>Flat terminals</b> Set of incoming or outgoing flat terminals
1	0 262 40		<b>Padlock for DRX 630</b> For locking on "OFF" position (up to 3 locks)
1	4 210 11		<b>Control and signalling auxiliaries for DRX 630</b> For DPX <sup>3</sup> , DPX <sup>3</sup> -I and DRX
			<b>Auxiliary contact or fault signal</b> For signalling the state of the contacts or opening of the MCCB on a fault Changeover switch 3 A - 240 V <sub>~</sub>
			<b>Shunt releases</b> Shunt inrush power 300 V <sub>~</sub> Coil voltage
1	4 222 39		24 V <sub>~</sub> and =
1	4 222 40		48 V <sub>~</sub> and =
1	4 222 41		110 V <sub>~</sub> and =
1	4 222 42		230 V <sub>~</sub> and =
1	4 222 43		400 V <sub>~</sub> and =
			<b>Undervoltage releases</b> Undervoltage power consumption 5 V <sub>~</sub> Coil voltage
1	4 222 44		24 V <sub>~</sub>
1	4 222 45		24 V <sub>~</sub>
1	4 222 46		48 V <sub>~</sub> and =
1	4 222 47		110 V <sub>~</sub> and =
1	4 222 48		230 V <sub>~</sub> and =
1	4 222 49		400 V <sub>~</sub> and =

# DRX™ 630

## technical characteristics and curves

### Curves

DRX 630  $I_{max} = 630\text{ A}$  from 36kA to 50 kA 3P - 4P

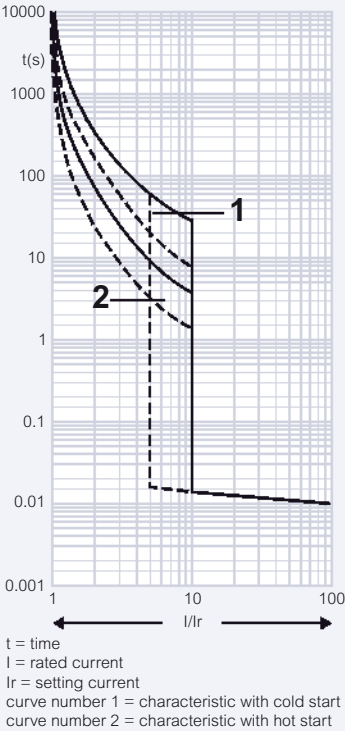

### Pass-through specific energy characteristics

DRX 630  $I_{max} = 630\text{ A}$  from 36kA to 50 kA 3P - 4P at 415 V~

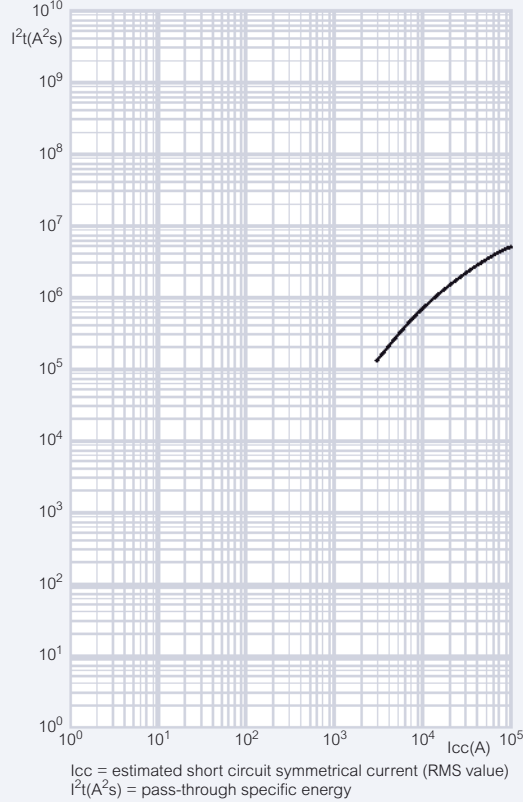

### Current limitation

DRX 630  $I_{max} = 630\text{ A}$  from 36kA to 50 kA 3P - 4P

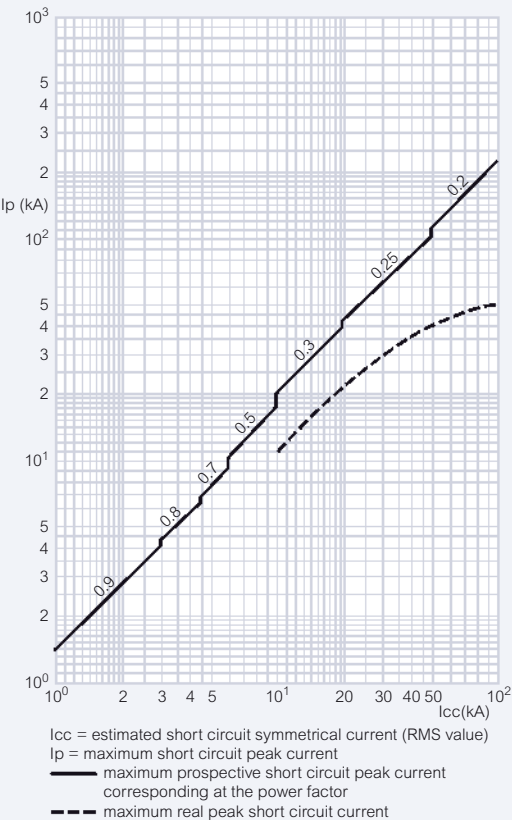

### Technical characteristics

	DRX - 36 kA	DRX - 50 kA
<b>Number of poles</b>	3P - 4P	3P - 4P
<b>Nominal current <math>I_n</math> (A)</b>	320-630	320-630
<b>Neutral protection for 4P version (%)</b>	100	100
<b>Rated insulation voltage <math>U_i</math> (V)</b>	690	690
<b>Rated impulse withstand current <math>U_{imp}</math> (kV)</b>	6	6
<b>Rated operating voltage (50/60 Hz) <math>U_e</math> (V)</b>	600	600
	220/240 V~	65
	380/415 V~	36
<b>Ultimate breaking capacity <math>I_{cu}</math> (kA) IEC 60947-2</b>	440/460 V~	30
	480/550 V~	25
	125 V=	40
	250 V=	36
<b>Ultimate breaking capacity <math>I_{cu}</math> (kA) NEMA AB-1</b>	240 V~	60
	480 V~	25
	550 V~	25
<b>Standard breaking capacity <math>I_{cs}</math> (% <math>I_{cu}</math>)</b>		50
<b>Category of use</b>		A
<b>Suitable for isolation</b>		YES
<b>Endurance (cycles)</b>	mechanical	25000
	electrical at $I_n$	8000
	electrical at 0.5 $I_n$	10000

1: 2 poles in series

### 2 poles in series

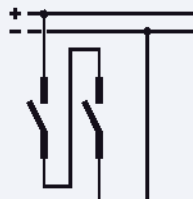

# DRX™ 630

dimensions, mounting principle and connection

## Dimensions

3P

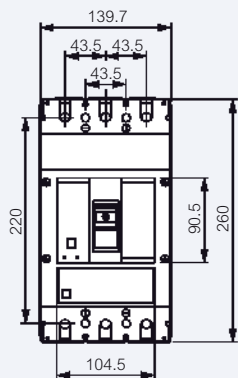

4P

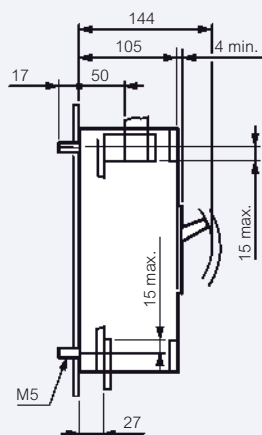
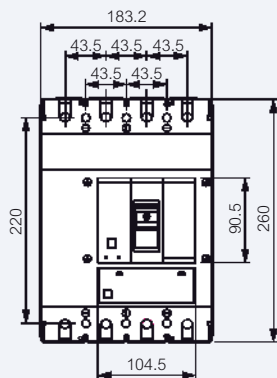

## Door cut

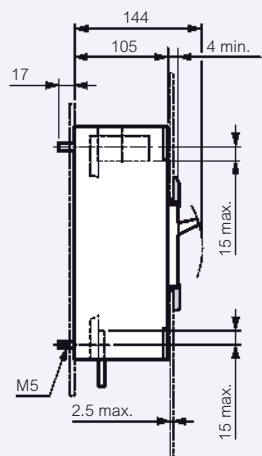
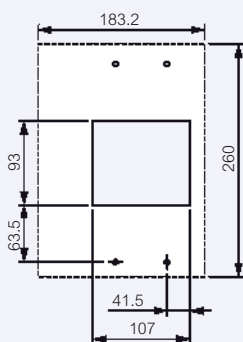
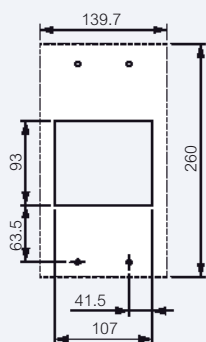

## Rotary handle-direct on DPX

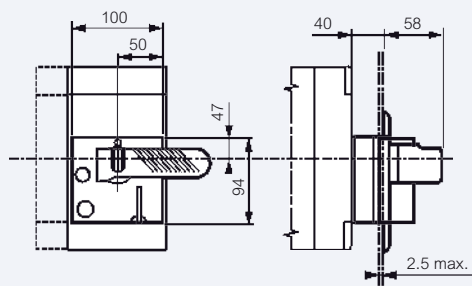

## Terminal shields

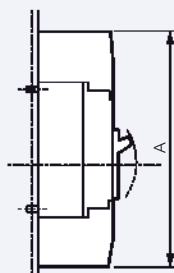

## Rotary handle-vari-depth handle on door

Mounting with flexible seal

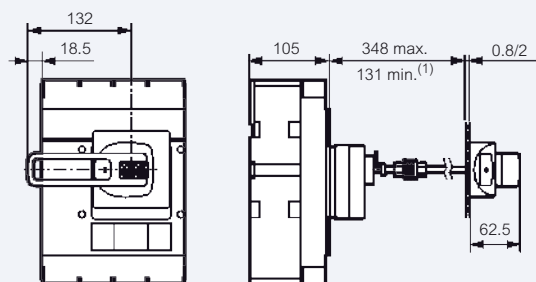

1: 75 mm without mechanical system

## Connection

### Connection via busbar

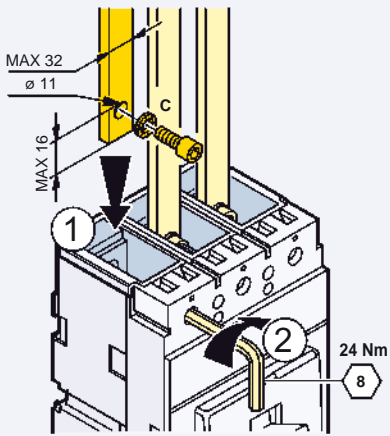





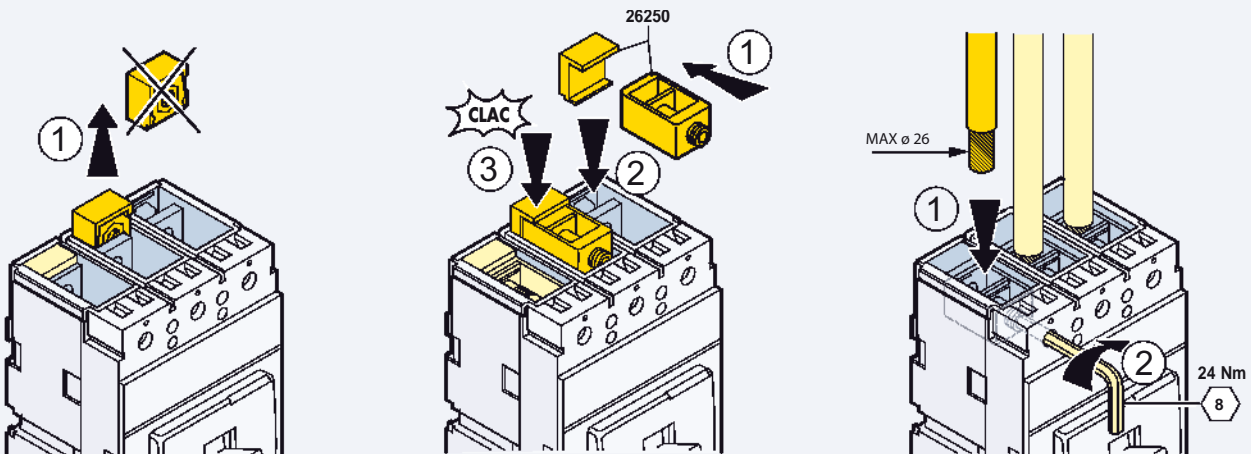

### Connection via cable

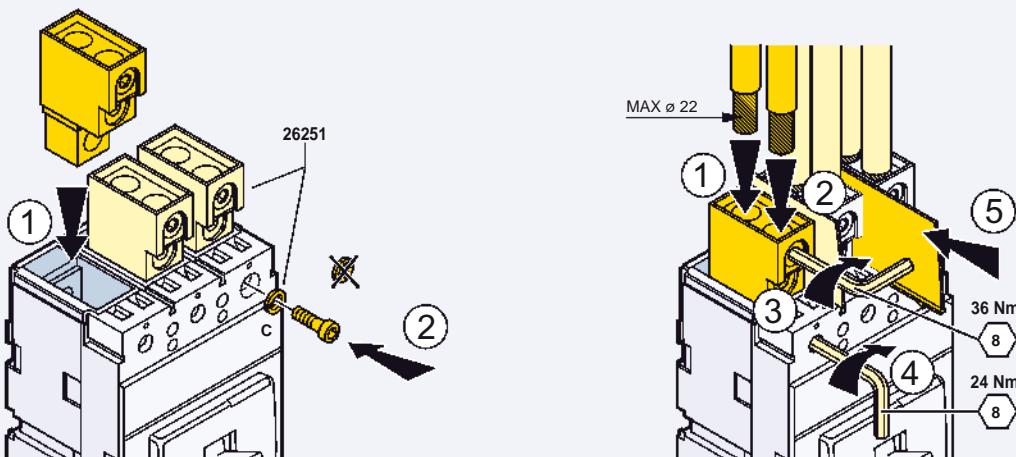
With cage terminals Cat.No 0 262 50



With high capacity cage terminals Cat.No 0 262 51

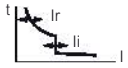
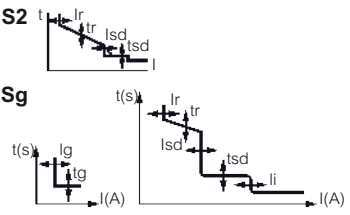

																
DEVICES	DPX <sup>3</sup> 160 thermal magnetic				DPX <sup>3</sup> 250 thermal magnetic				DPX <sup>3</sup> 250 electronic release							
Mounting	On rail  or on plate				On rail  or on plate				On rail  or on plate							
Breaking capacity (kA) (EN 60947-2 and IEC 60947-2)	16 kA	25 kA	36 kA	50 kA	25 kA	36 kA	50 kA	70 kA	25 kA	36 kA	50 kA	70 kA				
380/415 V~	16	25	36	50	25	36	50	70	25	36	50	70				
220/240 V~	25	35	50	65	40	60	100	100	40	60	100	100				
Breaking capacity (% Icu)	100	100	100	100	100	100	100	100	100	100	100	100				
Characteristic of use																
Nominal frequency	50/60 Hz															
Maximum rated operating voltage Ue	690 V (500 V with integrated e.l.c.bs)				690 V (500 V with integrated e.l.c.bs)				690 V (500 V with integrated e.l.c.bs)							
Category of use	A				A				A							
Thermal magnetic adjustment																
	Thermal	0,8 to 1 I <sub>n</sub>				0,8 to 1 I <sub>n</sub>				-						
	Magnetic	10 I <sub>n</sub> (400 A for 16 A and 25 A sizes)				5 to 10 I <sub>n</sub>				-						
Electronic protection adjustment																
																
	I <sub>r</sub> : 0,4 to 1 I <sub>n</sub> I <sub>sd</sub> : 1,5 to 10 I <sub>r</sub>															
Maximum cable cross-section																
Rigid cable	120 mm <sup>2</sup>				185 mm <sup>2</sup>				185 mm <sup>2</sup>							
Flexible cable	95 mm <sup>2</sup>				150 mm <sup>2</sup>				150 mm <sup>2</sup>							
Copper bar and lug width	18 mm				25 mm <sup>(1)</sup>				25 mm <sup>(1)</sup>							
Tightening torque	8 Nm				10 Nm				10 Nm							
Nominal current (I <sub>n</sub> ) at 40 °C (A)																
I <sub>n</sub> (A)	16	25	40	63	80	100	125	160	100	160	200	250	40	100	160	250
Phase	16	25	40	63	80	100	125	160	100	160	200	250	40	100	160	250
N	16	25	40	63	80	100	125	160	100	160	200	250	40	100	160	250
N/2	-	-	-	-	-	-	-	-	-	-	-	-	-	-	-	-
Magnetic threshold (I <sub>m</sub> ) (A) <sup>(2)</sup> of DPX <sup>3</sup> thermal magnetic	Fixed				Adjustable				Adjustable							
I <sub>n</sub> (A)	16	25	40	63	80	100	125	160	100	160	200	250	-			
Phase	400	400	400	630	800	1000	1250	1600	125-250	200-400	315-630	500-1000	-			
N	400	400	400	630	800	1000	1250	1600	125-250	200-400	315-630	500-1000	-			
N/2	-	-	-	-	-	-	-	-	-	-	-	-	-			
Endurance (cycles)																
Electrical	8000				8000				8000							
Mechanical	25000				20000				20000							
Electronic earth leakage module																
Type	without or integrated				without or integrated				without or integrated							

1: Copper bars only

2: Trip current for 50/60 Hz. For direct current, multiply by 1.5





**DPX³ 630**  
thermal magnetic

**DPX³ 630**  
electronic release

**DPX³ 1600**  
thermal magnetic

**DPX³ 1600**  
electronic release

On plate

On plate

On plate

On plate

On plate				On plate				On plate				On plate			
36 kA	50 kA	70 kA	100 kA	36 kA	50 kA	70 kA	100 kA	36 kA	50 kA	70 kA	100 kA	36 kA	50 kA	70 kA	100 kA
36	50	70	100	36	50	70	100	36	50	70	100	36	50	70	100
70	100	120	170	70	100	120	170	70	100	120	170	70	100	120	170
100	100	100	100	100	100	100	100	100	100	100	100	100	100	100	100

50/60 Hz

690 V~

690 V~

690 V~

690 V~

A

A: In 630 A - B: In 200 to 400 A

A

B

0.8 to 1 In

-

0.8 to 1 In

-

5 to 10 In

-

5 to 10 In

-

	S2	Sg
$I_r = 0.4 - 1 \times I_n$	•	•
$t_r = 3-30$ s	•	•
$I_{sd} = 1.5 - 10 I_r$	•	•
$t_{sd} (I=K) = 0-500$ ms	•	•
$t_{sd} (I^2t=K) = 0-500$ ms	•	•
$I_g = 0.2 - 1 \times I_n$	•	•
$t_g = 0.1 - 1$ s	•	•

	S2	Sg
$I_r = 0.4 - 1 \times I_n$	•	•
$t_r = 3-30$ s	•	•
$I_{sd} = 1.5 - 10 I_r$	•	•
$t_{sd} (I=K) = 0-500$ ms	•	•
$t_{sd} (I^2t=K) = 0-500$ ms	•	•
$I_g = 0.2 - 1 \times I_n$	•	•
$t_g = 0.1 - 1$ s	•	•

300 mm<sup>2</sup> or 2 x 240 mm<sup>2</sup>

300 mm<sup>2</sup> or 2 x 240 mm<sup>2</sup>

2 or 4 x 240 mm<sup>2</sup>

2 or 4 x 240 mm<sup>2</sup>

240 mm<sup>2</sup> or 2 x 185 mm<sup>2</sup>

240 mm<sup>2</sup> or 2 x 185 mm<sup>2</sup>

2 or 4 x 185 mm<sup>2</sup>

2 or 4 x 185 mm<sup>2</sup>

32 mm

32 mm

50 mm

50 mm

15 Nm

20 Nm

250	320	400	500	630	250	320	400	500	630	500	630	800	1000	1250	500	630	800	1000	1250	1600
250	320	400	500	630	250	320	400	500	630	500	630	800	1000	1250	500	630	800	1000	1250	1600
250	320	400	500	630	0 - 50 - 100 % of phase value					500	630	800	1000	1250	0 - 50 - 100 % of phase value					
-	250	250	250	320	-					-	-	-	500	630	-					

Adjustable

250	320	400	500	630	-					500	630	800	1000	1250	-				
1250-2500	1600-3200	2000-4000	2500-5000	3150-6300	-					2500-5000	3150-6300	4000-8000	5000-10000	6250-12500	-				
1250-2500	1600-3200	2000-4000	2500-5000	3150-6300	-					2500-5000	3150-6300	4000-8000	5000-10000	6250-12500	-				
-	1000-2000	1250-2500	1600-2500	2000-4000	-					-	-	-	?	?	-				

5000

5000

4000

4000

10000

20000

10000

10000

downstream e.l.c.bs.

downstream e.l.c.bs.

-

-

# DPX<sup>3</sup> 160 thermal magnetic

MCCBs from 16 to 160 A



Electrical characteristics **see e-catalogue**  
Dimensions **see e-catalogue**

Can be mounted on rail or on plate in XL<sup>3</sup> cabinets and enclosures  
MCCBs for switching, control isolation and protection of low voltage electrical lines  
Supplied with cage terminals 70 mm<sup>2</sup> max. (flexible cable) or 95 mm<sup>2</sup> max. rigid cable with accessories  
Can be fitted with accessories and DPX<sup>3</sup> common auxiliaires (p. 126)  
Conform to IEC 60947-2

Pack	Cat.Nos		MCCBs - fixed version	Pack	Cat.Nos	MCCBs with electronic earth leakage module - fixed version
			Thermal adjustable from 0,8 to 1 In Magnetic fixed at 10 In (fixed at 400 A for In 16 A and 25 A)			Thermal adjustable from 0,8 to 1 In Magnetic fixed at 10 In (fixed at 400 A for In 16 A and 25 A) Equipped with earth leakage module with LCD screen Adjustable sensitivity: 0.03 - 0.3 - 1 - 3 A Adjustable tripping: 0 - 0.3 - 1 - 3s (with 0.03 A possible only 0 s)
			<b>Breaking capacity Icu 16 kA (400 V~)</b>			<b>Breaking capacity Icu 16 kA (400 V~)</b>
			In (A)			In (A)
	3P	4P			4P	
1	4 200 00	4 200 10	16	1	4 200 30	16
1	4 200 01	4 200 11	25	1	4 200 31	25
1	4 200 02	4 200 12	40	1	4 200 32	40
1	4 200 03	4 200 13	63	1	4 200 33	63
1	4 200 04	4 200 14	80	1	4 200 34	80
1	4 200 05	4 200 15	100	1	4 200 35	100
1	4 200 06	4 200 16	125	1	4 200 36	125
1	4 200 07	4 200 17	160	1	4 200 37	160
			<b>Breaking capacity Icu 25 kA (400 V~)</b>			<b>Breaking capacity Icu 25 kA (400 V~)</b>
1	4 200 40	4 200 50	16	1	4 200 70	16
1	4 200 41	4 200 51	25	1	4 200 71	25
1	4 200 42	4 200 52	40	1	4 200 72	40
1	4 200 43	4 200 53	63	1	4 200 73	63
1	4 200 44	4 200 54	80	1	4 200 74	80
1	4 200 45	4 200 55	100	1	4 200 75	100
1	4 200 46	4 200 56	125	1	4 200 76	125
1	4 200 47	4 200 57	160	1	4 200 77	160
			<b>Breaking capacity Icu 36 kA (400 V~)</b>			<b>Breaking capacity Icu 36 kA (400 V~)</b>
1	4 200 80	4 200 90	16	1	4 201 10	16
1	4 200 81	4 200 91	25	1	4 201 11	25
1	4 200 82	4 200 92	40	1	4 201 12	40
1	4 200 83	4 200 93	63	1	4 201 13	63
1	4 200 84	4 200 94	80	1	4 201 14	80
1	4 200 85	4 200 95	100	1	4 201 15	100
1	4 200 86	4 200 96	125	1	4 201 16	125
1	4 200 87	4 200 97	160	1	4 201 17	160
			<b>Breaking capacity Icu 50 kA (400 V~)</b>			<b>Breaking capacity Icu 50 kA (400 V~)</b>
1	4 201 20	4 201 30	16	1	4 201 50	16
1	4 201 21	4 201 31	25	1	4 201 51	25
1	4 201 22	4 201 32	40	1	4 201 52	40
1	4 201 23	4 201 33	63	1	4 201 53	63
1	4 201 24	4 201 34	80	1	4 201 54	80
1	4 201 25	4 201 35	100	1	4 201 55	100
1	4 201 26	4 201 36	125	1	4 201 56	125
1	4 201 27	4 201 37	160	1	4 201 57	160

# DPX<sup>3</sup> 160 equipment and mounting accessories



# DPX<sup>3</sup> 160 connection



4 210 40



4 210 36

Pack	Cat.Nos	Equipment for plug-in version
		A plug-in version DPX <sup>3</sup> is a fixed version DPX <sup>3</sup> mounted on a plug-in base
		<b>Plug-in bases for DPX<sup>3</sup> 160</b>
1	4 210 40	Front or rear terminal mounting base For DPX <sup>3</sup> 160 - 3P
1	4 210 41	For DPX <sup>3</sup> 160 - 4P with or without earth leakage module
		<b>Connectors for auxiliary contacts</b>
1	4 210 44	Set of connectors
		<b>Padlocks for plug-in base</b>
1	4 210 45	Key barrel and flat key N° ABA90GEL6149
1	4 210 46	Key barrel and star key N° HBA90GPS6149
1	4 210 47	Padlock accessory
		<b>Connection accessories</b>
		<b>High capacity cage terminals</b>
		For Cu/Al cables, 1 x 120 mm <sup>2</sup> for flexible cables and 1 x 150 mm <sup>2</sup> for rigid cable and 18 mm bars
1	4 210 26	Set of 3 terminals
1	4 210 27	Set of 4 terminals
		<b>Cage terminals</b>
		For Cu/Al cables, 1 x 70 mm <sup>2</sup> for flexible cables and 1 x 95 mm <sup>2</sup> for rigid cables and 14 mm bars
1	4 210 93	Set of 3 terminals
1	4 210 94	Set of 4 terminals
		<b>Insulated shields</b>
1	4 210 70	Set of 3 insulated shields
		<b>Screw terminals for bars connection</b>
		For copper bars
1	4 210 28	Set of 3 terminals
1	4 210 29	Set of 4 terminals
		<b>Spreaders</b>
		For incoming bars or cable lugs
1	4 210 32	Set of 3 spreaders for DPX <sup>3</sup> 160 3P
1	4 210 33	Set of 4 spreaders for DPX <sup>3</sup> 160 4P
		<b>Rear terminals</b>
		Flat swivel terminals
		Used to convert a fixed version with front terminals to a fixed version with rear terminals
1	4 210 36	Set of 3 rear terminals for DPX <sup>3</sup> 160 3P
1	4 210 37	Set of 4 rear terminals for DPX <sup>3</sup> 160 4P
		<b>Sealable terminal shields</b>
		<b>For front terminals</b>
1	4 210 54	For DPX <sup>3</sup> 160 3P
1	4 210 55	For DPX <sup>3</sup> 160 3P
		<b>For rear terminals</b>
1	4 210 50	For DPX <sup>3</sup> 160 3P
1	4 210 51	For DPX <sup>3</sup> 160 4P
		<b>Fixing plates</b>
		For fixing DPX <sup>3</sup> 160 on L rail or on plate
1	4 210 71	For DPX <sup>3</sup> 160 3P/4P without earth leakage module
1	4 210 73	For DPX <sup>3</sup> 160 4P with earth leakage module
1	4 210 68	For DPX <sup>3</sup> 160 3P/4P with side mounting motor operator

## Connection

### Direct connection

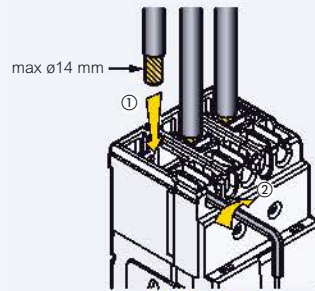

<b>Flexible</b>	
1,5	→ 70 mm <sup>2</sup>
#16	→ #2/0 AWG
or	
<b>Solid</b>	
1,5	→ 95 mm <sup>2</sup>
#16	→ #4/0 AWG

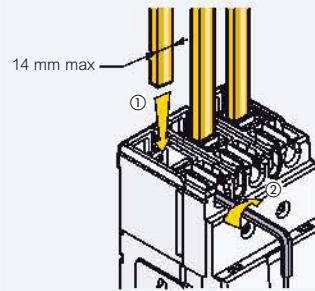

### Spreaders

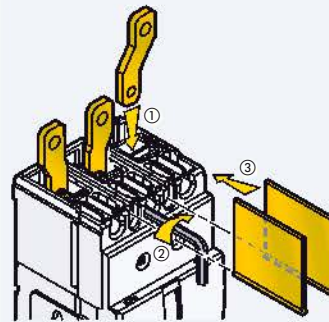

### Rear terminals

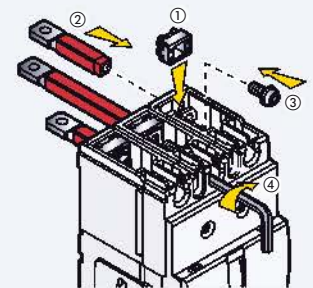

### Sealable terminal shield

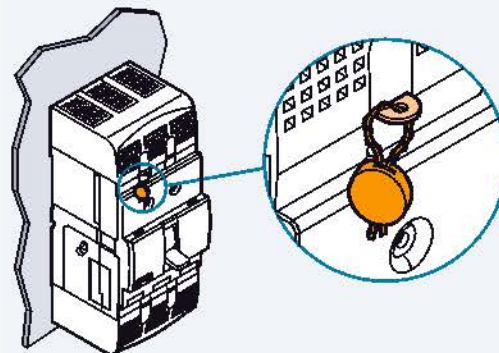

# DPX<sup>3</sup> 250 thermal magnetic

MCCBs from 100 to 250 A



4 202 05



4 202 25

Electrical characteristics **see e-catalogue**  
Dimensions **see e-catalogue**

Can be mounted on rail or on plate in XL<sup>3</sup> cabinets and enclosures  
MCCBs for switching, control isolation and protection of low voltage electrical lines  
Supplied with insulated shIELDS, cage terminals 120 mm<sup>2</sup> max. (flexible cable) or 150 mm<sup>2</sup> max. rigid cable with accessories  
Can be fitted with accessories and DPX<sup>3</sup> common auxiliaires (p. 126)  
Conform to IEC 60947-2

Pack	Cat.Nos		In (A)
	3P	4P	
	<b>MCCBs - fixed version</b>		
	Thermal adjustable from 0,8 to 1 In Magnetic adjustable from 5 to 10 In		
	<b>Breaking capacity Icu 25 kA (400 V~)</b>		
1	4 202 05	4 202 15	100
1	4 202 07	4 202 17	160
1	4 202 08	4 202 18	200
1	4 202 09	4 202 19	250
	<b>Breaking capacity Icu 36 kA (400 V~)</b>		
1	4 202 35	4 202 45	100
1	4 202 37	4 202 47	160
1	4 202 38	4 202 48	200
1	4 202 39	4 202 49	250
	<b>Breaking capacity Icu 50 kA (400 V~)</b>		
1	4 202 65	4 202 75	100
1	4 202 67	4 202 77	160
1	4 202 68	4 202 78	200
1	4 202 69	4 202 79	250
	<b>Breaking capacity Icu 70 kA (400 V~)</b>		
1	4 206 05	4 206 15	100
1	4 206 07	4 206 17	160
1	4 206 08	4 206 18	200
1	4 206 09	4 206 19	250

Pack	Cat.Nos	In (A)
	4P	
	<b>MCCBs with electronic earth leakage module - fixed version</b>	
	Thermal adjustable from 0,8 to 1 In Magnetic adjustable from 5 to 10 In Equipped with earth leakage module with LCD screen Adjustable sensitivity: 0.03 - 0.3 - 1 - 3 A Adjustable tripping: 0 - 0.3 - 1 - 3s (with 0.03 A possible only 0s)	
	<b>Breaking capacity Icu 25 kA (400 V~)</b>	
1	4 202 25	100
1	4 202 27	160
1	4 202 28	200
1	4 202 29	250
	<b>Breaking capacity Icu 36 kA (400 V~)</b>	
1	4 202 55	100
1	4 202 57	160
1	4 202 58	200
1	4 202 59	250
	<b>Breaking capacity Icu 50 kA (400 V~)</b>	
1	4 202 85	100
1	4 202 87	160
1	4 202 88	200
1	4 202 89	250
	<b>Breaking capacity Icu 70 kA (400 V~)</b>	
1	4 206 25	100
1	4 206 27	160
1	4 206 28	200
1	4 206 29	250

# DPX<sup>3</sup> 250 electronic release

MCCBs from 40 to 250 A



4 203 69



4 203 25

Electrical characteristics **see e-catalogue**  
Dimensions **see e-catalogue**

Can be mounted on rail or on plate in XL<sup>3</sup> cabinets and enclosures  
MCCBs for switching, control isolation and protection of low voltage electrical lines  
Supplied with insulated shIELDS, cage terminals 120 mm<sup>2</sup> max. (flexible cable) or 150 mm<sup>2</sup> max. rigid cable with accessories  
Can be fitted with accessories and DPX<sup>3</sup> common auxiliaires (p. 126)  
Conform to IEC 60947-2

Pack	Cat.Nos		MCCBs - fixed version
			Protection against overloads: I <sub>r</sub> adjustable from 0.4 to 1 x I <sub>n</sub> t <sub>r</sub> adjustable from 3 to 15s Protection against short circuits: I <sub>sd</sub> adjustable from 1.5 to 10 x I <sub>r</sub> t <sub>sd</sub> adjustable from 0 to 0.5s
			<b>Breaking capacity I<sub>cu</sub> 25 kA (400 V<math>\sim</math>)</b>
	3P	4P	I <sub>n</sub> (A)
1	4 203 02	4 203 12	40
1	4 203 05	4 203 15	100
1	4 203 07	4 203 17	160
1	4 203 09	4 203 19	250
			<b>Breaking capacity I<sub>cu</sub> 36 kA (400 V<math>\sim</math>)</b>
1	4 203 32	4 203 42	40
1	4 203 35	4 203 45	100
1	4 203 37	4 203 47	160
1	4 203 39	4 203 49	250
			<b>Breaking capacity I<sub>cu</sub> 50 kA (400 V<math>\sim</math>)</b>
1	4 203 62	4 203 72	40
1	4 203 65	4 203 75	100
1	4 203 67	4 203 77	160
1	4 203 69	4 203 79	250
			<b>Breaking capacity I<sub>cu</sub> 70 kA (400 V<math>\sim</math>)</b>
1	4 206 35	4 206 45	40
1	4 206 37	4 206 47	100
1	4 206 38	4 206 48	160
1	4 206 39	4 206 49	250

Pack	Cat.Nos	MCCBs with electronic earth leakage module - fixed version
		Protection against overloads: I <sub>r</sub> adjustable from 0.4 to 1 x I <sub>n</sub> t <sub>r</sub> adjustable from 3 to 15s Protection against short circuits: I <sub>sd</sub> adjustable from 1.5 to 10 x I <sub>r</sub> t <sub>sd</sub> adjustable from 0 to 0.5s Equipped with earth leakage module with LCD screen Adjustable sensitivity: 0.03 - 0.3 - 1 - 3 A Adjustable tripping: 0 - 0.3 - 1 - 3s (with 0.03 A possible only 0s)
		<b>Breaking capacity I<sub>cu</sub> 25 kA (400 V<math>\sim</math>)</b>
	4P	I <sub>n</sub> (A)
1	4 203 22	40
1	4 203 25	100
1	4 203 27	160
1	4 203 29	250
		<b>Breaking capacity I<sub>cu</sub> 36 kA (400 V<math>\sim</math>)</b>
1	4 203 52	40
1	4 203 55	100
1	4 203 57	160
1	4 203 59	250
		<b>Breaking capacity I<sub>cu</sub> 50 kA (400 V<math>\sim</math>)</b>
1	4 203 82	40
1	4 203 85	100
1	4 203 87	160
1	4 203 89	250
		<b>Breaking capacity I<sub>cu</sub> 70 kA (400 V<math>\sim</math>)</b>
1	4 206 55	40
1	4 206 57	100
1	4 206 58	160
1	4 206 59	250

# DPX<sup>3</sup> 250 electronic release

MCCBs from 40 to 250 A (continued)



4 206 79

4 204 25

Electrical characteristics **see e-catalogue**  
Dimensions **see e-catalogue**

Can be mounted on rail or on plate in XL<sup>3</sup> cabinets and enclosures  
MCCBs for switching, control isolation and protection of low voltage electrical lines  
Supplied with insulated shileds, cage terminals 120 mm<sup>2</sup> max. (flexible cable) or 150 mm<sup>2</sup> max. rigid cable with accessories  
Can be fitted with accessories and DPX<sup>3</sup> common auxiliaires (p. 126)  
Conform to IEC 60947-2

Pack	Cat.Nos		
			<b>MCCBs with energy metering central unit - fixed version</b>
			Protection against overloads: I <sub>r</sub> adjustable from 0.4 to 1 x I <sub>n</sub> t <sub>r</sub> adjustable from 3 to 15s Protection against short circuits: I <sub>sd</sub> adjustable from 1.5 to 10 x I <sub>r</sub> t <sub>sd</sub> adjustable from 0 to 0.5s Integrated energy metering central unit with LCD screen; currents, voltage, frequency, power, energy and harmonics
			<b>Breaking capacity I<sub>cu</sub> 25 kA (400 V<sub>~</sub>)</b>
	3P	4P	I <sub>n</sub> (A)
1	4 204 02	4 204 12	40
1	4 204 05	4 204 15	100
1	4 204 07	4 204 17	160
1	4 204 09	4 204 19	250
			<b>Breaking capacity I<sub>cu</sub> 36 kA (400 V<sub>~</sub>)</b>
1	4 204 32	4 204 42	40
1	4 204 35	4 204 45	100
1	4 204 37	4 204 47	160
1	4 204 39	4 204 49	250
			<b>Breaking capacity I<sub>cu</sub> 50 kA (400 V<sub>~</sub>)</b>
1	4 204 62	4 204 72	40
1	4 204 65	4 204 75	100
1	4 204 67	4 204 77	160
1	4 204 69	4 204 79	250
			<b>Breaking capacity I<sub>cu</sub> 70 kA (400 V<sub>~</sub>)</b>
1	4 206 65	4 206 75	40
1	4 206 67	4 206 77	100
1	4 206 68	4 206 78	160
1	4 206 69	4 206 79	250

Pack	Cat.Nos	
		<b>MCCBs with energy metering central unit and electronic earth leakage module - fixed version</b>
		Protection against overloads: I <sub>r</sub> adjustable from 0.4 to 1 x I <sub>n</sub> t <sub>r</sub> adjustable from 3 to 15s Protection against short circuits: I <sub>sd</sub> adjustable from 1.5 to 10 x I <sub>r</sub> t <sub>sd</sub> adjustable from 0 to 0.5s Equipped with earth leakage module with LCD screen
		Adjustable sensitivity: 0.03 - 0.3 - 1 - 3 A Adjustable tripping: 0 - 0.3 - 1 - 3s (with 0.03 A possible only 0s) Integrated energy metering central unit with LCD screen; currents, voltage, frequency, power, energy and harmonics
		<b>Breaking capacity I<sub>cu</sub> 25 kA (400 V<sub>~</sub>)</b>
	4P	I <sub>n</sub> (A)
1	4 204 22	40
1	4 204 25	100
1	4 204 27	160
1	4 204 29	250
		<b>Breaking capacity I<sub>cu</sub> 36 kA (400 V<sub>~</sub>)</b>
1	4 204 52	40
1	4 204 55	100
1	4 204 57	160
1	4 204 59	250
		<b>Breaking capacity I<sub>cu</sub> 50 kA (400 V<sub>~</sub>)</b>
1	4 204 82	40
1	4 204 85	100
1	4 204 87	160
1	4 204 89	250
		<b>Breaking capacity I<sub>cu</sub> 70 kA (400 V<sub>~</sub>)</b>
1	4 206 85	40
1	4 206 87	100
1	4 206 88	160
1	4 206 89	250

# DPX<sup>3</sup> 250 electronic release

MCCBs from 40 to 250 A (continued)



# DPX<sup>3</sup> 250 equipment and mounting accessories



4 205 49

Electrical characteristics **see e-catalogue**  
Dimensions **see e-catalogue**

Can be mounted on rail or on plate in XL<sup>3</sup> cabinets and enclosures MCCBs for switching, control isolation and protection of low voltage electrical lines

Supplied with insulated shileds, cage terminals 120 mm<sup>2</sup> max. (flexible cable) or 150 mm<sup>2</sup> max. rigid cable with accessories

Can be fitted with accessories and DPX<sup>3</sup> common auxiliaires (p. 126)

Conform to IEC 60947-2

Pack	Cat.Nos		Electronic release Sg MCCBs - fixed version
	3P	4P	
			Protection against overloads: I <sub>r</sub> adjustable from 0.4 to 1 x I <sub>n</sub> t <sub>r</sub> adjustable from 3 to 15s Protection against short circuits: I <sub>sd</sub> adjustable from 1.5 to 10 x I <sub>r</sub> t <sub>sd</sub> adjustable from 0 to 0.5s Protection against earth fault: I <sub>g</sub> adjustable: from 0.2 to 1 x I <sub>n</sub> and OFF position t <sub>g</sub> adjustable from 0.1 to 1s
			<b>Breaking capacity I<sub>cu</sub> 25 kA (400 V<sub>~</sub>)</b>
			I <sub>n</sub> (A)
1	4 205 02	4 205 12	40
1	4 205 05	4 205 15	100
1	4 205 07	4 205 17	160
1	4 205 09	4 205 19	250
			<b>Breaking capacity I<sub>cu</sub> 36 kA (400 V<sub>~</sub>)</b>
1	4 205 22	4 205 32	40
1	4 205 25	4 205 35	100
1	4 205 27	4 205 37	160
1	4 205 29	4 205 39	250
			<b>Breaking capacity I<sub>cu</sub> 50 kA (400 V<sub>~</sub>)</b>
1	4 205 42	4 205 52	40
1	4 205 45	4 205 55	100
1	4 205 47	4 205 57	160
1	4 205 49	4 205 59	250
			<b>Breaking capacity I<sub>cu</sub> 70 kA (400 V<sub>~</sub>)</b>
1	4 206 92	4 207 02	40
1	4 206 95	4 207 05	100
1	4 206 97	4 207 07	160
1	4 206 99	4 207 09	250



4 210 44



4 210 31



4 210 72

Pack	Cat.Nos	Equipment for plug-in version
		A plug-in version DPX <sup>3</sup> is a fixed version DPX <sup>3</sup> mounted on a plug-in base
		<b>Plug-in bases for DPX<sup>3</sup> 250</b>
		Front or rear terminal mounting base
1	4 210 42	For DPX <sup>3</sup> 250 - 3P
1	4 210 43	For DPX <sup>3</sup> 250 - 4P with or without earth leakage module
		<b>Connectors for auxiliary contacts</b>
1	4 210 44	Set of connectors
		<b>Padlocks for plug-in base</b>
1	4 210 45	Key barrel and flat key N° ABA90GEL6149
1	4 210 46	Key barrel and star key N° HBA90GPS6149
1	4 210 47	Padlock accessory
		<b>Connection accessories</b>
		<b>Cage terminals</b>
		For Cu/Al cables, 1 x 120 mm <sup>2</sup> for flexible cables and 1 x 150 mm <sup>2</sup> for rigid cables and lugs 28.5 x 8 x 8.5 mm
1	4 210 30	Set of 3 terminals
1	4 210 31	Set of 4 terminals
		<b>Screw terminals for bar connections</b>
1	4 210 79	Set of 3 terminals
1	4 210 80	Set of 4 terminals
		<b>Insulated shields</b>
1	4 210 70	Set of 3 insulated shields
		<b>Spreaders</b>
		For incoming bars or cable lugs
1	4 210 34	Set of 3 spreaders for DPX <sup>3</sup> 250 3P
1	4 210 35	Set of 4 spreaders for DPX <sup>3</sup> 250 4P
		<b>Rear terminals</b>
		Flat swivel terminals
		Used to convert a fixed version with front terminals to a fixed version with rear terminals
1	4 210 38	Set of 3 rear terminals for DPX <sup>3</sup> 250 3P
1	4 210 39	Set of 4 rear terminals for DPX <sup>3</sup> 250 4P
		<b>Sealable terminal shields</b>
		<b>For front terminals</b>
1	4 210 56	For DPX <sup>3</sup> 250 3P
1	4 210 57	For DPX <sup>3</sup> 250 4P
		<b>For rear terminals</b>
1	4 210 52	For DPX <sup>3</sup> 250 3P
1	4 210 53	For DPX <sup>3</sup> 250 4P
		<b>Fixing plates</b>
		For fixing DPX <sup>3</sup> 250 on  rail or on plate
1	4 210 72	For DPX <sup>3</sup> 250 3P/4P without earth leakage module
1	4 210 74	For DPX <sup>3</sup> 250 4P with earth leakage module
1	4 210 69	For DPX <sup>3</sup> 250 3P/4P with side mounting motor operator



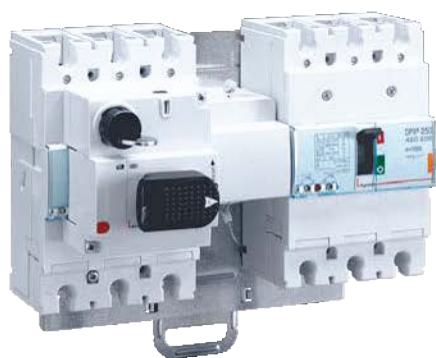

4 210 58



4 210 00



4 210 10



4 210 11



4 210 16



4 210 22

Pack	Cat.Nos	Supply inverter type
1	4 210 58	Plate for mounting and interlocking of 2 DPX <sup>3</sup> For 2 DPX <sup>3</sup> 160 or 2 DPX <sup>3</sup> 250 or 1 DPX <sup>3</sup> 160 and 1 DPX <sup>3</sup> 250
1	4 210 59	For fixed version For plug-in and draw-out version
<b>Rotary handles</b>		
<b>Direct on DPX</b>		
1	4 210 00	Standard handle for thermal magnetic DPX <sup>3</sup> without earth leakage module
1	4 210 01	Standard handle for electronic DPX <sup>3</sup> and/or with earth leakage module
1	4 210 02	Handle for emergency use for thermal magnetic DPX <sup>3</sup> without earth leakage module
1	4 210 03	Handle for emergency use for electronic DPX <sup>3</sup> and/or with earth leakage module
<b>Vari-depth handles</b>		
For all version of DPX <sup>3</sup>		
1	4 210 04	Standard handle
1	4 210 05	Handle for emergency use
<b>Locking accessories</b>		
1	4 210 06	Key barrel and flat key N° ABA90GEL6149 for direct handle
1	4 210 07	Key barrel and star key N° HBA90GPS6149 for direct handle
1	4 210 08	Key barrel and flat key N° ABA90GEL6149 for vari-depth handle
1	4 210 09	Key barrel and star key N° HBA90GPS6149 for vari-depth handle
<b>Motor-driven handles</b>		
<b>Motor operators 24 to 230 V~ / =</b>		
1	4 210 60	Side motor operator
1	4 210 61	Front motor operator
<b>Locking accessories</b>		
1	4 210 62	Key barrel and flat key N° ABA90GEL6149 for front motor operator
1	4 210 63	Key barrel and star key N° HBA90GPS6149 for front motor operator
1	4 210 64	Padlock for front motor operator
1	4 210 65	Key barrel and flat key N° ABA90GEL6149 for side motor operator
1	4 210 66	Key barrel and star key N° HBA90GPS6149 for side motor operator
1	4 210 67	Padlock for side motor operator

Pack	Cat.Nos	Auxiliaries
<b>Auxiliary contacts</b>		
1	4 210 10	1 N/C + 1 N/O auxiliary contact for rotary handles
1	4 210 11	Auxiliary contact or fault signalling contact
1	4 210 48	Signalling contact plugged-in / drawn-out (for DPX <sup>3</sup> plug-in version)
<b>Shunt releases</b>		
1	4 210 12	12 V~ / =
1	4 210 13	24 V~ / =
1	4 210 14	48 V~ / =
1	4 210 15	110-130 V~ / =
1	4 210 16	200-277 V~ / =
1	4 210 17	380-480 V~ / =
<b>Undervoltage releases</b>		
1	4 210 18	12 V~ / =
1	4 210 19	24 V~ / =
1	4 210 20	48 V~ / =
1	4 210 21	110-130 V~ / =
1	4 210 22	200-240 V~ / =
1	4 210 23	277 V~
1	4 210 24	380-415 V~
1	4 210 25	440-480 V~
<b>Locking accessory</b>		
1	4 210 49	Padlock for locking in "open" position
<b>Communication interface</b>		
1	4 210 75	Modbus



# DPX<sup>3</sup> 160/250

## installation principle

### Auxiliaries mounting

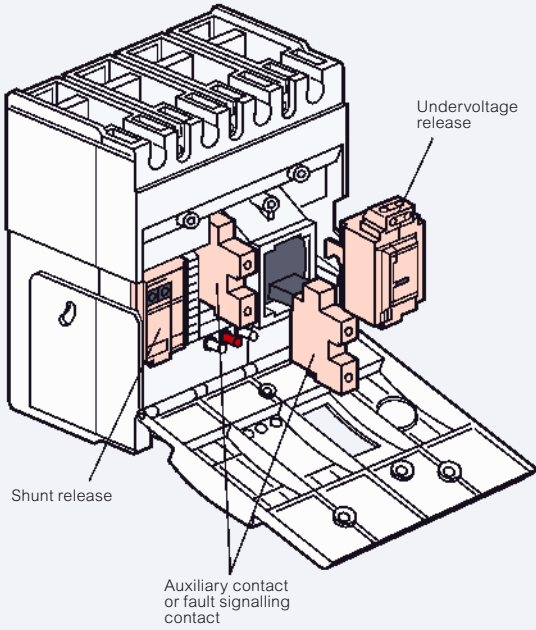

### Direct rotary handle

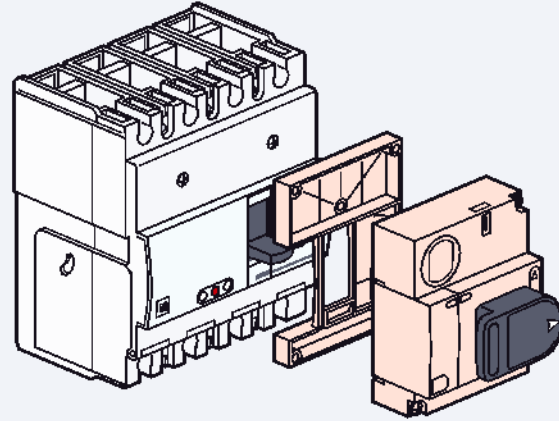

### Plug-in version

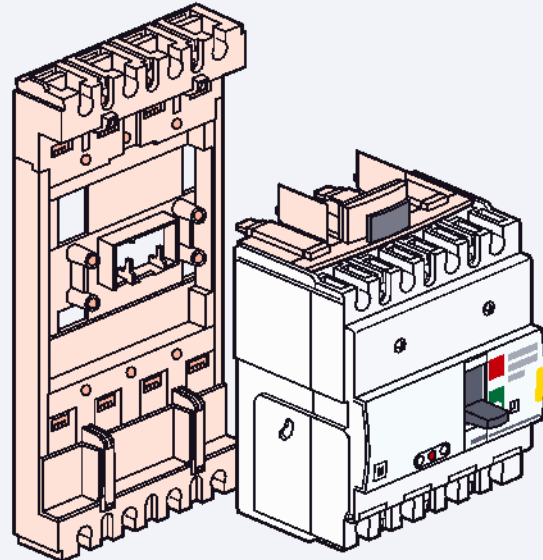

### Side mounting motor-driven handle

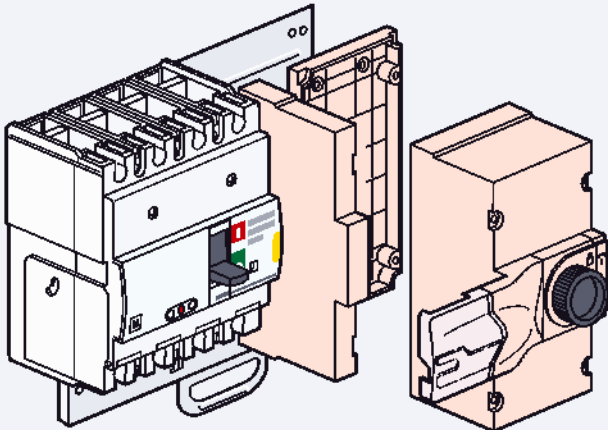

### Front mounting motor-driven handle

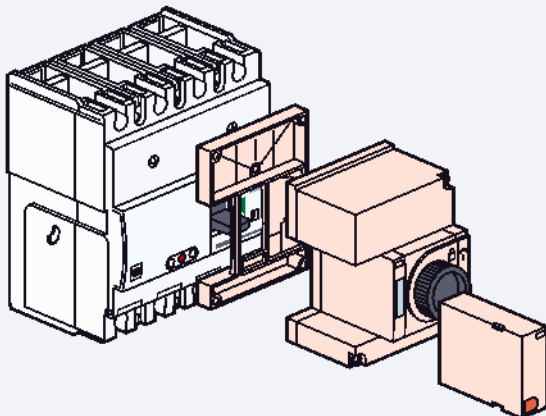

### Supply inverter type

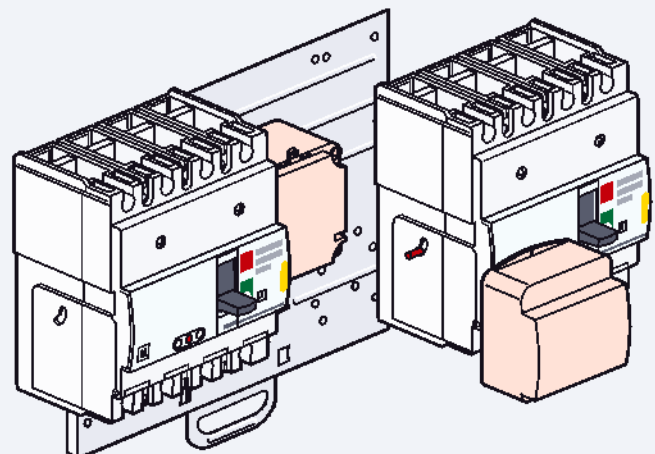

**DPX<sup>3</sup> 630**

thermal magnetic release MCCBs from 250 to 630 A



4 220 02



4 220 07

 Dimensions **see e-catalogue**  
Electrical characteristics **see e-catalogue**

Moulded case MCCBs for switching, control isolation and protection of low voltage electrical lines

Can be fitted with auxiliaries (p. 138)

Can be used with earth leakage modules (p. 132) or with residual current relays (p. 139)

Supplied complete with:

- connection plates for bars

- terminal shields

Conform to IEC 60947-2 - Sealable adjustment

Can be mounted on plate in XL<sup>3</sup> cabinets and enclosures

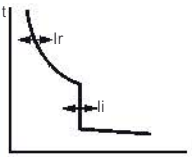
Pack	Cat.Nos		
			<b>MCCBs thermal magnetic release - fixed version</b>
			Thermal adjustable from 0.8 to 1 In Magnetic adjustable from 5 to 10 In
			
			<b>Breaking capacity Icu 36 kA (400 V~)</b>
	3P	4P	In (A)
1	4 220 00	4 220 05	250
1	4 220 01	4 220 06	320
1	4 220 02	4 220 07	400
1	4 220 03	4 220 08	500
1	4 220 04	4 220 09	630
	3P + N/2		
1	4 220 10		320
1	4 220 11		400
1	4 220 12		500
1	4 220 13		630
			<b>Breaking capacity Icu 50 kA (400 V~)</b>
	3P	4P	In (A)
1	4 220 14	4 220 19	250
1	4 220 15	4 220 20	320
1	4 220 16	4 220 21	400
1	4 220 17	4 220 22	500
1	4 220 18	4 220 23	630
	3P + N/2		
1	4 220 24		320
1	4 220 25		400
1	4 220 26		500
1	4 220 27		630

Pack	Cat.Nos		
			<b>MCCBs thermal magnetic release - fixed version (continued)</b>
			<b>Breaking capacity Icu 70 kA (400 V~)</b>
	3P	4P	In (A)
1	4 220 28	4 220 33	250
1	4 220 29	4 220 34	320
1	4 220 30	4 220 35	400
1	4 220 31	4 220 36	500
1	4 220 32	4 220 37	630
	3P + N/2		
1	4 220 38		320
1	4 220 39		400
1	4 220 40		500
1	4 220 41		630
			<b>Breaking capacity Icu 100 kA (400 V~)</b>
	3P	4P	In (A)
1	4 220 42	4 220 47	250
1	4 220 43	4 220 48	320
1	4 220 44	4 220 49	400
1	4 220 45	4 220 50	500
1	4 220 46	4 220 51	630
	3P + N/2		
1	4 220 52		320
1	4 220 53		400
1	4 220 54		500
1	4 220 55		630

# DPX<sup>3</sup> 630

S1 electronic release MCCBs from 250 to 630 A



# DPX<sup>3</sup> 630/1600

electronic release



4 225 00



4 225 05

Dimensions **see e-catalogue**  
 Electrical characteristics **see e-catalogue**

Moulded case MCCBs for switching, control isolation and protection of low voltage electrical lines  
 Can be fitted with auxiliaries (p. 138)  
 Can be used with earth leakage modules (p. 132) or with residual current relays (p. 139)  
 Supplied complete with:  
 - connection plates for bars  
 - terminal shields  
 Conform to IEC 60947-2 - Sealable adjustment  
 Can be mounted on plate in XL<sup>3</sup> cabinets and enclosures

Pack	Cat.Nos		MCCBs electronic release S1 - fixed version
	3P	4P	
	<b>AVAILABLE MARCH 2015</b>		
			<b>Breaking capacity I<sub>cu</sub> 36 kA (400 V~)</b>
			In (A)
1	4 224 98	4 225 03	250
1	4 224 99	4 225 04	320
1	4 225 00	4 225 05	400
1	4 225 01	4 225 06	500
1	4 225 02	4 225 07	630
			<b>Breaking capacity I<sub>cu</sub> 50 kA (400 V~)</b>
1	4 225 08	4 225 13	250
1	4 225 09	4 225 14	320
1	4 225 10	4 225 15	400
1	4 225 11	4 225 16	500
1	4 225 12	4 225 17	630
			<b>Breaking capacity I<sub>cu</sub> 70 kA (400 V~)</b>
1	4 225 18	4 225 23	250
1	4 225 19	4 225 24	320
1	4 225 20	4 225 25	400
1	4 225 21	4 225 26	500
1	4 225 22	4 225 27	630
			<b>Breaking capacity I<sub>cu</sub> 100 kA (400 V~)</b>
1	4 225 28	4 225 33	250
1	4 225 29	4 225 34	320
1	4 225 30	4 225 35	400
1	4 225 31	4 225 36	500
1	4 225 32	4 225 37	630

## Performance data

### S1 - Adjustment of Ir, I<sub>sd</sub>

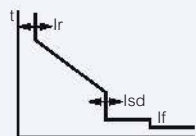

Protection against overloads:  
 - Ir adjustable from 0.4 to 1 x I<sub>n</sub>  
 Protection against short circuits:  
 - I<sub>sd</sub> adjustable from 1.5 to 10 x I<sub>r</sub>  
 Instantaneous protection I<sub>f</sub> = 5 kA

### S2 - Adjustment of Ir, tr, I<sub>sd</sub>, t<sub>sd</sub>

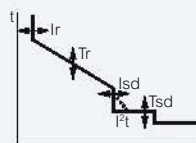

Protection against overloads:  
 - Ir adjustable from 0.4 to 1 x I<sub>n</sub>  
 - tr adjustable from 3 to 15 s  
 Protection against short circuits:  
 - I<sub>sd</sub> adjustable from 1.5 to 10 x I<sub>r</sub>  
 - t<sub>sd</sub> adjustable from 0 to 0.5 s

### Sg - Adjustment of Ir, tr, I<sub>sd</sub>, t<sub>sd</sub>, I<sub>g</sub>, t<sub>g</sub>

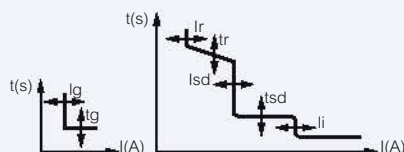

Protection against overloads:  
 - Ir adjustable from 0.4 to 1 x I<sub>n</sub>  
 - tr adjustable from 3 to 15 s  
 Protection against short circuits:  
 - I<sub>sd</sub> adjustable from 1.5 to 10 x I<sub>r</sub>  
 - t<sub>sd</sub> adjustable from 0 to 0.5 s  
 Protection against earth fault:  
 - I<sub>g</sub> adjustable: from 0.2 to 1 x I<sub>n</sub> and OFF position  
 - t<sub>g</sub> adjustable from 0.1 to 1 s

For DPX 630 electronic release S1 **please consult us**





4 220 60



4 220 65

Dimensions **see e-catalogue**  
 Electrical characteristics **see e-catalogue**

Moulded case MCCBs for switching, control isolation and protection of low voltage electrical lines

Can be fitted with auxiliaries (p. 138)

Can be used with earth leakage modules (p. 132) or with residual current relays (p. 139)

Supplied complete with:

- connection plates for bars

- terminal shields

Conform to IEC 60947-2 - Sealable adjustment

Can be mounted on plate in XL<sup>3</sup> cabinets and enclosures

Pack	Cat.Nos		
			<b>MCCBs electronic release S2 - fixed version</b>
			Adjustment of $I_r$ , $I_{sd}$ , $t_r$ , $t_{sd}$ (p. 129) Instantaneous protection $I_f = 5$ kA Green indicator lamp Connector for test unit Logic and dynamic selectivity 4P version: adjustment of neutral on front panel
			<b>Breaking capacity <math>I_{cu}</math> 36 kA (400 V<math>\sim</math>)</b>
	3P	4P	In (A)
1	4 220 56	4 220 61	250
1	4 220 57	4 220 62	320
1	4 220 58	4 220 63	400
1	4 220 59	4 220 64	500
1	4 220 60	4 220 65	630
			<b>Breaking capacity <math>I_{cu}</math> 50 kA (400 V<math>\sim</math>)</b>
1	4 220 66	4 220 71	250
1	4 220 67	4 220 72	320
1	4 220 68	4 220 73	400
1	4 220 69	4 220 74	500
1	4 220 70	4 220 75	630
			<b>Breaking capacity <math>I_{cu}</math> 70 kA (400 V<math>\sim</math>)</b>
1	4 220 76	4 220 81	250
1	4 220 77	4 220 82	320
1	4 220 78	4 220 83	400
1	4 220 79	4 220 84	500
1	4 220 80	4 220 85	630
			<b>Breaking capacity <math>I_{cu}</math> 100 kA (400 V<math>\sim</math>)</b>
1	4 220 86	4 220 91	250
1	4 220 87	4 220 92	320
1	4 220 88	4 220 93	400
1	4 220 89	4 220 94	500
1	4 220 90	4 220 95	630

Pack	Cat.Nos		
			<b>MCCBs electronic release S2 with energy metering central unit - fixed version</b>
			Adjustment of $I_r$ , $I_{sd}$ , $t_r$ , $t_{sd}$ (p. 129) Instantaneous protection $I_f = 5$ kA Green indicator lamp Connector for test unit Logic and dynamic selectivity 4P version: adjustment of neutral on front panel
			<b>Breaking capacity <math>I_{cu}</math> 36 kA (400 V<math>\sim</math>)</b>
	3P	4P	In (A)
1	4 220 96	4 221 01	250
1	4 220 97	4 221 02	320
1	4 220 98	4 221 03	400
1	4 220 99	4 221 04	500
1	4 221 00	4 221 05	630
			<b>Breaking capacity <math>I_{cu}</math> 50 kA (400 V<math>\sim</math>)</b>
1	4 221 06	4 221 11	250
1	4 221 07	4 221 12	320
1	4 221 08	4 221 13	400
1	4 221 09	4 221 14	500
1	4 221 10	4 221 15	630
			<b>Breaking capacity <math>I_{cu}</math> 70 kA (400 V<math>\sim</math>)</b>
1	4 221 16	4 221 21	250
1	4 221 17	4 221 22	320
1	4 221 18	4 221 23	400
1	4 221 19	4 221 24	500
1	4 221 20	4 221 25	630
			<b>Breaking capacity <math>I_{cu}</math> 100 kA (400 V<math>\sim</math>)</b>
1	4 221 26	4 221 31	250
1	4 221 27	4 221 32	320
1	4 221 28	4 221 33	400
1	4 221 29	4 221 34	500
1	4 221 30	4 221 35	630

# DPX<sup>3</sup> 630

Sg electronic release MCCBs from 250 to 630 A



4 221 38



4 221 43

Dimensions **see e-catalogue**  
 Electrical characteristics **see e-catalogue**

Moulded case MCCBs for switching, control isolation and protection of low voltage electrical lines

Can be fitted with auxiliaries (p. 138)

Can be used with earth leakage modules (p. 132) or with residual current relays (p. 139)

Supplied complete with:

- connection plates for bars
- terminal shields

Conform to IEC 60947-2 - Sealable adjustment

Can be mounted on plate in XL<sup>3</sup> cabinets and enclosures

Pack	Cat.Nos		
			<b>MCCBs electronic release Sg - fixed version</b>
			Adjustment of $I_r$ , $I_{sd}$ , $I_g$ , $t_r$ , $t_{sd}$ , $t_g$ (p. 129) Instantaneous protection $I_f = 5$ kA Green indicator lamp Connector for test unit Logic and dynamic selectivity 4P version: adjustment of neutral on front panel
			<b>Breaking capacity <math>I_{cu}</math> 36 kA (400 V<math>\sim</math>)</b>
	3P	4P	$I_n$ (A)
1	4 221 36	4 221 41	250
1	4 221 37	4 221 42	320
1	4 221 38	4 221 43	400
1	4 221 39	4 221 44	500
1	4 221 40	4 221 45	630
			<b>Breaking capacity <math>I_{cu}</math> 50 kA (400 V<math>\sim</math>)</b>
1	4 221 46	4 221 51	250
1	4 221 47	4 221 52	320
1	4 221 48	4 221 53	400
1	4 221 49	4 221 54	500
1	4 221 50	4 221 55	630
			<b>Breaking capacity <math>I_{cu}</math> 70 kA (400 V<math>\sim</math>)</b>
1	4 221 56	4 221 61	250
1	4 221 57	4 221 62	320
1	4 221 58	4 221 63	400
1	4 221 59	4 221 64	500
1	4 221 60	4 221 65	630
			<b>Breaking capacity <math>I_{cu}</math> 100 kA (400 V<math>\sim</math>)</b>
1	4 221 66	4 221 71	250
1	4 221 67	4 221 72	320
1	4 221 68	4 221 73	400
1	4 221 69	4 221 74	500
1	4 221 70	4 221 75	630

Pack	Cat.Nos		
			<b>MCCBs electronic release Sg with energy metering central unit - fixed version</b>
			Adjustment of $I_r$ , $I_{sd}$ , $I_g$ , $t_r$ , $t_{sd}$ , $t_g$ (p. 129) Instantaneous protection $I_f = 5$ kA Green indicator lamp Connector for test unit Logic and dynamic selectivity 4P version: adjustment of neutral on front panel
			<b>Breaking capacity <math>I_{cu}</math> 36 kA (400 V<math>\sim</math>)</b>
	3P	4P	$I_n$ (A)
1	4 221 76	4 221 81	250
1	4 221 77	4 221 82	320
1	4 221 78	4 221 83	400
1	4 221 79	4 221 84	500
1	4 221 80	4 221 85	630
			<b>Breaking capacity <math>I_{cu}</math> 50 kA (400 V<math>\sim</math>)</b>
1	4 221 86	4 221 91	250
1	4 221 87	4 221 92	320
1	4 221 88	4 221 93	400
1	4 221 89	4 221 94	500
1	4 221 90	4 221 95	630
			<b>Breaking capacity <math>I_{cu}</math> 70 kA (400 V<math>\sim</math>)</b>
1	4 221 96	4 222 01	250
1	4 221 97	4 222 02	320
1	4 221 98	4 222 03	400
1	4 221 99	4 222 04	500
1	4 222 00	4 222 05	630
			<b>Breaking capacity <math>I_{cu}</math> 100 kA (400 V<math>\sim</math>)</b>
1	4 222 06	4 222 11	250
1	4 222 07	4 222 12	320
1	4 222 08	4 222 13	400
1	4 222 09	4 222 14	500
1	4 222 10	4 222 15	630

## DPX<sup>3</sup> 630

earth leakage modules



0 260 63

Pack	Cat.Nos		Earth leakage modules
			Can be fitted onto DPX <sup>3</sup> /DPX <sup>3</sup> -I 630 Adjustable, sealable sensitivity: 0.03 - 0.3 - 1 - 3 A Adjustable, time delay: 0 - 0.3 - 1 - 3 s Test push-button Reset push-button Remote earth fault signalling contact Switch for mechanical tests (installation insulation test) Mounted underneath 230-500 V~
	3P	4P	<b>Standard</b>
1	0 260 60	0 260 61	In (A) 400
1	0 260 64	0 260 65	630
			<b>LED version</b>
			Monitors the isolation state of the installation via a series of LEDs
	4P		In (A)
1	0 260 63		400
1	0 260 67		630

## DPX<sup>3</sup> 630

equipment and accessories

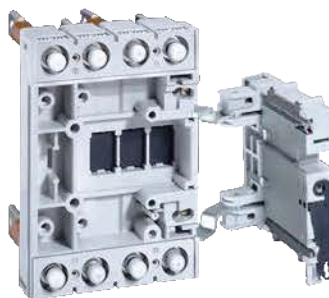

4 222 25

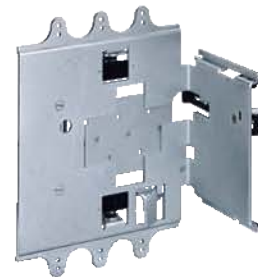

4 222 32

Pack	Cat.Nos		Plug-in version
			A plug-in is a DPX <sup>3</sup> fitted with special terminals and mounted on a plug-in base
	3P	4P	<b>Special terminals for plug-in/draw-out base</b>
1	4 222 20	4 222 21	Set of incoming and outgoing terminals (6 terminals for 3P DPX <sup>3</sup> or 8 terminals for 4P DPX <sup>3</sup> )
			<b>Bases for DPX<sup>3</sup> only</b>
			Accept DPX <sup>3</sup> /DPX <sup>3</sup> -I fitted with special terminals
1	4 222 22	4 222 23	Front terminal mounting base
1	4 222 24	4 222 25	Flat rear terminal mounting base
			<b>Bases for DPX<sup>3</sup> with earth leakage module</b>
1	4 222 26		Front terminal mounting base
1	4 222 27		Flat rear terminal mounting base
			<b>Accessories</b>
1	4 222 28		Set of 2 extractor handle
1	4 222 29		Set of connectors (24-pin)
			<b>Draw-out version</b>
			A DPX <sup>3</sup> draw-out version is a plug-in DPX <sup>3</sup> fitted with a "Debro-lift" mechanism which can be used to withdraw the DPX <sup>3</sup> while keeping it on its base
			<b>"Debro-lift" mechanism</b>
			Supplied with a rigid slide and handle for drawing-out
1	4 222 31	4 222 32	For DPX <sup>3</sup> base only
1		4 222 33	For DPX <sup>3</sup> base with earth leakage module
			<b>Key-lock for "Debro-lift" mechanism</b>
			Enable locking of DPX <sup>3</sup> in drawn-out position
			Flat key n°HBA90GPS6149
			Star key n°ABA90GEL6149
1	Flat key 0 265 76	Star key 0 263 48	One key for DPX <sup>3</sup> only
1	0 265 78	0 265 77	Two keys (one key supplied) for motorised DPX <sup>3</sup> or with rotary handle
			<b>Accessories for "Debro-lift" mechanism</b>
1	0 265 75		Handle for drawing-out
1	0 265 74		Signalling contact (plugged-in/drawn-out)
			<b>Auxiliary contacts</b>
1	4 222 30		Automatic auxiliary contacts for DPX <sup>3</sup> draw-out version (up to 2 contacts by DPX <sup>3</sup> )
			<b>Supply inverter type</b>
			Factory assembled
			A supply inverter type is composed of one plate with interlock for 2 devices
1	0 264 09		Plate for MCCB or trip-free switch fixed version
1	0 264 04		Plate for MCCB or trip-free switch plug-in and draw-out version



# DPX<sup>3</sup> 630

## equipment and accessories (continued)



0 261 40



0 262 50



0 262 51



0 262 48

Pack	Cat.Nos	Rotary handles
1	0 262 41	<b>Direct on DPX<sup>3</sup></b>
1	0 262 24	Standard (grey) For emergency use (red/yellow) - can be fitted on Cat.Nos 0 262 22, 0 262 41 or 0 262 81
		<b>Vari-depth handle IP 55</b>
		Comprising: connection rod, bracket, self-adhesive drilling template, mounting accessories and door lock mechanism
1	0 262 81	Standard (grey)
1	0 262 82	For emergency use (red/yellow) can be fitted on Cat.Nos 0 262 81 or 0 262 41
		<b>Locking accessories</b>
		For vary-depth handle
1	0 262 93	Key barrel and flat key N° ABA90GEL6149
1	0 262 94	Key barrel and star key N° HBA90GPS6149
		<b>Motor-driven handles</b>
		<b>Front operated</b>
1	0 261 40	24 V~ / =
1	0 261 41	48 V~ / =
1	0 261 44	230 V~
		<b>Accessories</b>
1	0 261 59	Lock and flat key N° ABA90GEL6149
1	0 261 58	Lock and star key N° HBA90GPS6149

Pack	Cat.Nos	Accessories
1	0 262 30	<b>Insulated shields</b> Set of 3
1	0 262 44   0 262 45	<b>Sealable terminal shields</b> Set of 2 3P   4P
1	0 262 40	<b>Padlock</b> For locking in "OPEN" position
1	0 262 50	<b>Cage terminals</b> Set of 4 terminals for cable 300 mm <sup>2</sup> max. (rigid) or 240 mm <sup>2</sup> max. (flexible)
1	0 262 51	Set of 4 high-capacity terminals for cable 2 x 240 mm <sup>2</sup> (rigid) or 2 x 185 mm <sup>2</sup> (flexible)
1	0 262 46	<b>Adaptor for lug</b> For connecting bare cables with wide lugs Set of 4 adaptors + insulated shields
1	0 262 47	<b>Extended front terminals</b> Set of 4
1	0 262 48   0 262 49	<b>Spreaders</b> Set of incoming or outgoing spreaders 3P   4P
		<b>Rear terminals</b>
		Used to convert the fixed version with front terminals to the fixed version with rear terminals
1	0 263 50   0 263 51	Set of incoming or outgoing swivel terminals
1	0 263 52   0 263 53	Set of incoming or outgoing flat terminals
1	4 222 34   4 222 35	<b>IP 20 terminal covers</b> Set of 2 terminal covers

# DPX<sup>3</sup> 1600

thermal magnetic release MCCBs from 630 to 1250 A

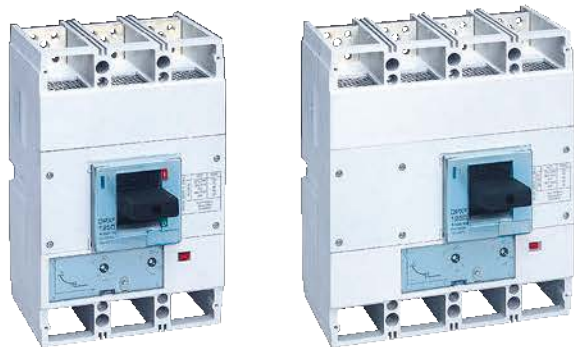

4 222 78

4 222 83

Dimensions **see e-catalogue**  
Electrical characteristics **see e-catalogue**

Moulded case MCCBs for switching, control isolation and protection of low voltage electrical lines  
Can be fitted with auxiliaries (p. 138)  
Can be used with residual current relays (p. 139)  
Supplied complete with:  
- connection plates for bars  
- terminal shields  
Conform to IEC 60947-2 - Sealable adjustment  
Can be mounted on plate in XL<sup>3</sup> cabinets and enclosures

Pack	Cat.Nos		
			<b>MCCBs thermal magnetic release fixed version</b>
			Thermal adjustable from 0.8 to 1 In Magnetic adjustable from 5 to 10 In
			<b>Breaking capacity Icu 36 kA (400 V~)</b>
	3P	4P	In (A)
1	4 222 51	4 222 56	630
1	4 222 52	4 222 57	800
1	4 222 53	4 222 58	1000
1	4 222 54	4 222 59	1250
	3P + N/2		
1	4 222 60		1000
1	4 222 61		1250
			<b>Breaking capacity Icu 50 kA (400 V~)</b>
	3P	4P	In (A)
1	4 222 63	4 222 68	630
1	4 222 64	4 222 69	800
1	4 222 65	4 222 70	1000
1	4 222 66	4 222 71	1250
	3P + N/2		
1	4 222 72		1000
1	4 222 73		1250
			<b>Breaking capacity Icu 70 kA (400 V~)</b>
	3P	4P	In (A)
1	4 222 75	4 222 80	630
1	4 222 76	4 222 81	800
1	4 222 77	4 222 82	1000
1	4 222 78	4 222 83	1250
	3P + N/2		
1	4 222 84		1000
1	4 222 85		1250
			<b>Breaking capacity Icu 100 kA (400 V~)</b>
	3P	4P	In (A)
1	4 222 87	4 222 92	630
1	4 222 88	4 222 93	800
1	4 222 89	4 222 94	1000
1	4 222 90	4 222 95	1250
	3P + N/2		
1	4 222 96		1000
1	4 222 97		1250

# DPX<sup>3</sup> 1600

S1 electronic release MCCBs from 630 to 1600 A

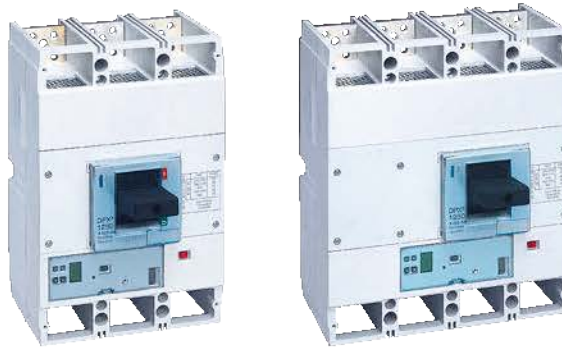

4 225 66

4 225 72

Dimensions **see e-catalogue**  
Electrical characteristics **see e-catalogue**

Moulded case MCCBs for switching, control isolation and protection of low voltage electrical lines  
Can be fitted with auxiliaries (p. 138)  
Can be used with residual current relays (p. 139)  
Supplied complete with:  
- connection plates for bars  
- terminal shields  
Conform to IEC 60947-2 - Sealable adjustment  
Can be mounted on plate in XL<sup>3</sup> cabinets and enclosures

Pack	Cat.Nos		
			<b>MCCBs electronic release S1 fixed version</b>
			Adjustment of Ir, Isd (p. 129) Instantaneous protection If = 20 kA Green indicator lamp Connector for test unit Dynamic selectivity 4P version: adjustment of neutral on front panel
			<b>Breaking capacity Icu 36 kA (400 V~)</b>
	3P	4P	In (A)
1	4 225 39	4 225 45	630
1	4 225 40	4 225 46	800
1	4 225 41	4 225 47	1000
1	4 225 42	4 225 48	1250
1	4 225 43	4 225 49	1600
			<b>Breaking capacity Icu 50 kA (400 V~)</b>
	3P	4P	In (A)
1	4 225 51	4 225 57	630
1	4 225 52	4 225 58	800
1	4 225 53	4 225 59	1000
1	4 225 54	4 225 60	1250
1	4 225 55	4 225 61	1600
			<b>Breaking capacity Icu 70 kA (400 V~)</b>
	3P	4P	In (A)
1	4 225 63	4 225 69	630
1	4 225 64	4 225 70	800
1	4 225 65	4 225 71	1000
1	4 225 66	4 225 72	1250
1	4 225 67	4 225 73	1600
			<b>Breaking capacity Icu 100 kA (400 V~)</b>
	3P	4P	In (A)
1	4 225 75	4 225 81	630
1	4 225 76	4 225 82	800
1	4 225 77	4 225 83	1000
1	4 225 78	4 225 84	1250

**AVAILABLE MARCH 2015**

For DPX 1600 electronic release S1 **please consult us**





# DPX<sup>3</sup> 1600

S2 electronic release MCCBs from 630 to 1600 A



4 223 27



4 223 33

Dimensions **see e-catalogue**  
 Electrical characteristics **see e-catalogue**

Moulded case MCCBs for switching, control isolation and protection of low voltage electrical lines

Can be fitted with auxiliaries (p. 138)

Can be used with residual current relays (p. 139)

Supplied complete with:

- connection plates for bars
- terminal shields

Conform to IEC 60947-2 - Sealable adjustment

Can be mounted on plate in XL<sup>3</sup> cabinets and enclosures

Pack	Cat.Nos		
			<b>MCCBs electronic release S2 fixed version</b>
			Adjustment of $I_r$ , $I_{sd}$ , $t_r$ , $t_{sd}$ (p. 129) Instantaneous protection $I_f = 20$ kA Green indicator lamp Connector for test unit Logic and dynamic selectivity 4P version: adjustment of neutral on front panel
			<b>Breaking capacity Icu 36 kA (400 V~)</b>
	3P	4P	$I_n$ (A)
1	4 223 99	4 223 05	630
1	4 223 00	4 223 06	800
1	4 223 01	4 223 07	1000
1	4 223 02	4 223 08	1250
1	4 223 03	4 223 09	1600
			<b>Breaking capacity Icu 50 kA (400 V~)</b>
1	4 223 11	4 223 17	630
1	4 223 12	4 223 18	800
1	4 223 13	4 223 19	1000
1	4 223 14	4 223 20	1250
1	4 223 15	4 223 21	1600
			<b>Breaking capacity Icu 70 kA (400 V~)</b>
1	4 223 23	4 223 29	630
1	4 223 24	4 223 30	800
1	4 223 25	4 223 31	1000
1	4 223 26	4 223 32	1250
1	4 223 27	4 223 33	1600
			<b>Breaking capacity Icu 100 kA (400 V~)</b>
1	4 223 35	4 223 41	630
1	4 223 36	4 223 42	800
1	4 223 37	4 223 43	1000
1	4 223 38	4 223 44	1250

Pack	Cat.Nos		
			<b>MCCBs electronic release S2 with energy metering central unit fixed version</b>
			Adjustment of $I_r$ , $I_{sd}$ , $t_r$ , $t_{sd}$ (p. 129) Instantaneous protection $I_f = 20$ kA Green indicator lamp Connector for test unit Logic and dynamic selectivity 4P version: adjustment of neutral on front panel
			<b>Breaking capacity Icu 36 kA (400 V~)</b>
	3P	4P	$I_n$ (A)
1	4 223 47	4 223 53	630
1	4 223 48	4 223 54	800
1	4 223 49	4 223 55	1000
1	4 223 50	4 223 56	1250
1	4 223 51	4 223 57	1600
			<b>Breaking capacity Icu 50 kA (400 V~)</b>
1	4 223 59	4 223 65	630
1	4 223 60	4 223 66	800
1	4 223 61	4 223 67	1000
1	4 223 62	4 223 68	1250
1	4 223 63	4 223 69	1600
			<b>Breaking capacity Icu 70 kA (400 V~)</b>
1	4 223 71	4 223 77	630
1	4 223 72	4 223 78	800
1	4 223 73	4 223 79	1000
1	4 223 74	4 223 80	1250
1	4 223 75	4 223 81	1600
			<b>Breaking capacity Icu 100 kA (400 V~)</b>
1	4 223 83	4 223 89	630
1	4 223 84	4 223 90	800
1	4 223 85	4 223 91	1000
1	4 223 86	4 223 92	1250



4 224 23



4 224 29

Dimensions **see e-catalogue**  
Electrical characteristics **see e-catalogue**

Moulded case MCCBs for switching, control isolation and protection of low voltage electrical lines

Can be fitted with auxiliaries (p. 138)

Can be used with residual current relays (p. 139)

Supplied complete with:

- connection plates for bars
- terminal shields

Conform to IEC 60947-2 - Sealable adjustment

Can be mounted on plate in XL<sup>3</sup> cabinets and enclosures

Pack	Cat.Nos		
			<b>MCCBs electronic release Sg fixed version</b>
			Adjustment of I <sub>r</sub> , I <sub>s</sub> d, I <sub>g</sub> , t <sub>r</sub> , t <sub>s</sub> d, t <sub>g</sub> (p. 129) Instantaneous protection I <sub>f</sub> = 20 kA Green indicator lamp Connector for test unit Logic and dynamic selectivity 4P version: adjustment of neutral on front panel
			<b>Breaking capacity I<sub>cu</sub> 36 kA (400 V~)</b>
	3P	4P	I <sub>n</sub> (A)
1	4 223 95	4 224 01	630
1	4 223 96	4 224 02	800
1	4 223 97	4 224 03	1000
1	4 223 98	4 224 04	1250
1	4 223 99	4 224 05	1600
			<b>Breaking capacity I<sub>cu</sub> 50 kA (400 V~)</b>
1	4 224 07	4 224 13	630
1	4 224 08	4 224 14	800
1	4 224 09	4 224 15	1000
1	4 224 10	4 224 16	1250
1	4 224 11	4 224 17	1600
			<b>Breaking capacity I<sub>cu</sub> 70 kA (400 V~)</b>
1	4 224 19	4 224 25	630
1	4 224 20	4 224 26	800
1	4 224 21	4 224 27	1000
1	4 224 22	4 224 28	1250
1	4 224 23	4 224 29	1600
			<b>Breaking capacity I<sub>cu</sub> 100 kA (400 V~)</b>
1	4 224 31	4 224 37	630
1	4 224 32	4 224 38	800
1	4 224 33	4 224 39	1000
1	4 224 34	4 224 40	1250

Pack	Cat.Nos		
			<b>MCCBs electronic release Sg with energy metering central unit fixed version</b>
			Adjustment of I <sub>r</sub> , I <sub>s</sub> d, I <sub>g</sub> , t <sub>r</sub> , t <sub>s</sub> d, t <sub>g</sub> (p. 129) Instantaneous protection I <sub>f</sub> = 20 kA Green indicator lamp Connector for test unit Logic and dynamic selectivity 4P version: adjustment of neutral on front panel
			<b>Breaking capacity I<sub>cu</sub> 36 kA (400 V~)</b>
	3P	4P	I <sub>n</sub> (A)
1	4 224 43	4 224 49	630
1	4 224 44	4 224 50	800
1	4 224 45	4 224 51	1000
1	4 224 46	4 224 52	1250
1	4 224 47	4 224 53	1600
			<b>Breaking capacity I<sub>cu</sub> 50 kA (400 V~)</b>
1	4 224 55	4 224 61	630
1	4 224 56	4 224 62	800
1	4 224 57	4 224 63	1000
1	4 224 58	4 224 64	1250
1	4 224 59	4 224 65	1600
			<b>Breaking capacity I<sub>cu</sub> 70 kA (400 V~)</b>
1	4 224 67	4 224 73	630
1	4 224 68	4 224 74	800
1	4 224 69	4 224 75	1000
1	4 224 70	4 224 76	1250
1	4 224 71	4 224 77	1600
			<b>Breaking capacity I<sub>cu</sub> 100 kA (400 V~)</b>
1	4 224 79	4 224 85	630
1	4 224 80	4 224 86	800
1	4 224 81	4 224 87	1000
1	4 224 82	4 224 88	1250

# DPX<sup>3</sup> 1600

## equipment and accessories

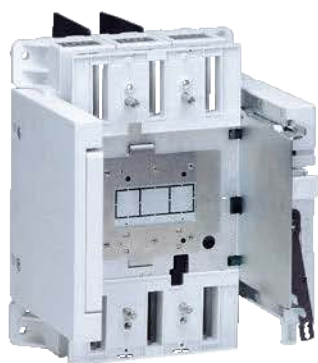

4 225 88 + 4 225 93



0 262 60



0 262 70



0 262 67 + 0 262 68

Pack	Cat.Nos	Draw-out version
1	3P 4P 4 225 86 4 225 87	A DPX <sup>3</sup> draw-out version is a DPX <sup>3</sup> fitted with draw-out base and a "Debro-lift" mechanism which can be used to withdraw the DPX <sup>3</sup> while keeping it on its base <b>Draw-out base</b> For DPX <sup>3</sup> 1600 equipped with "Debro-lift" mechanism Cat.No 4 225 93 or 4 225 94 Front terminals Rear terminals
1	4 225 88 4 225 89	
1	4 225 93 4 225 94	<b>"Debro-lift" mechanism</b> For DPX <sup>3</sup> 1600 To be fitted on a DPX <sup>3</sup> 1600 fixed version in order to obtain the movable part of a draw-out circuit breaker <b>Key-lock for "Debro-lift" mechanism</b> Enable locking of DPX <sup>3</sup> in drawn-out position Flat key n°HBA90GPS6149 Star key n°ABA90GEL6149 One key for DPX <sup>3</sup> only Two key (one key supplied) for motorised DPX <sup>3</sup> or with rotary handle
1	Flat key 0 265 76   Star key 0 263 48	
1	0 265 80   0 265 79	
1	0 265 75	<b>Accessories for "Debro-lift" mechanism</b> Handle for drawing-out Signalling contact (plugged-in/drawn-out)
1	0 265 74	
1	4 222 30	<b>Auxiliary contacts</b> Automatic auxiliary contacts for DPX <sup>3</sup> draw-out version (up to 2 contacts by DPX <sup>3</sup> )
<b>Supply inverter type</b>		
1	0 264 10	A supply inverter type is composed of one plate with interlock for 2 devices Plate for MCCBs or trip-free switch fixed version
1	0 264 05	Plate for MCCBs or trip-free switch plug-in and draw-out version
<b>Rotary handles</b>		
1	0 262 61	<b>Direct on DPX<sup>3</sup></b> Standard (black) <b>Vari-depth handle IP 55</b> Comprising: connection rod, bracket, self-adhesive drilling template, mounting accessories and door lock mechanism Standard (black) For emergency use (red/yellow)
1	0 262 83	
1	0 262 84	
1	0 262 93	<b>Locking accessories</b> Key barrel and flat key N° ABA90GEL6149
1	0 262 94	Key barrel and star key N° HBA90GPS6149

Pack	Cat.Nos	Motor-driven handles
1	0 261 54	<b>Factory assembled</b> Front operated 230 V~ <b>Customer assembled</b> Front operated 24 V~/= for In ≤ 1250 A 48 V~/= for In ≤ 1250 A 110 V~/= for In ≤ 1250 A 230 V~/= for In ≤ 1250 A 24 V~/= for In = 1600 A 48 V~/= for In = 1600 A 110 V~/= for In = 1600 A 230 V~/= for In = 1600 A
1	0 261 24	
1	0 261 25	
1	0 261 26	
1	0 261 23	
1	0 261 19	
1	0 261 28	
1	0 261 29	
1	0 261 27	
1	0 261 59	<b>Locking accessories</b> Key and flat key N° ABA90GEL6149 Key and star key N° HBA90GPS6149
1	0 261 58	
<b>Accessories</b>		
<b>Insulated shields</b> Used to isolate the connections between each pole Set of 3		
1	0 262 66	
1	3P 0 262 64   4P 0 262 65	<b>Sealable terminal shields</b> Set of 2
1	0 262 60	<b>Padlock</b> For locking in "open" position
1	0 262 69	<b>Gage terminals</b> Set of 1 terminal for cables without lug 2 x 240 mm <sup>2</sup> for rigid cable or 2 x 185 mm <sup>2</sup> for flexible cable Set of 1 high-capacity terminal for cables without lug 4 x 240 mm <sup>2</sup> for rigid cable 4 x 185 mm <sup>2</sup> for flexible cable
1	0 262 70	
1	0 262 67	<b>Extended front terminals</b> Set of 4 Short terminals for 630 - 1250 A (2 bars max. per pole) Long terminals for 1600 A (3 bars max. per pole)
1	0 262 68	
1	3P 0 262 73   4P 0 262 74	<b>Spreaders</b> Set of incoming or outgoing spreaders
1	0 263 80   0 263 82	<b>Rear terminals</b> Used to convert the fixed version with front terminals to the fixed version with rear terminals Set of incoming or outgoing rear terminals
1	0 263 81   0 263 83	Short terminals Long terminals
1	4 225 90   4 225 91	<b>IP 20 terminal covers</b> Set of 2 terminal covers
1	4 225 92	<b>External neutral</b> External neutral

For the old range of accessories for DPX 1600 draw-out version please consult us



0 261 93



0 261 78



0 261 56

Pack	Cat.Nos	Auxiliary contact or fault signal
1	4 210 11	For signalling the state of the contacts or opening of the MCCB on a fault For DPX <sup>3</sup> /DPX <sup>3</sup> -I/DPX-IS Changeover switch 3 A - 240 V~
		<b>Releases</b>
		Allow remote tripping of a DPX <sup>3</sup>
		<b>Shunt releases</b>
		For DPX-IS/DPX <sup>3</sup> -I and DPX <sup>3</sup> Shunt inrush power 300 VA
1	4 222 39	Colt voltage 24 V~ / =
1	4 222 40	Colt voltage 48 V~ / =
1	4 222 41	Colt voltage 110 V~ / =
1	4 222 42	Colt voltage 230 V~ / =
1	4 222 43	Colt voltage 400 V~ / =
		<b>Undervoltage releases</b>
		For DPX-IS/DPX <sup>3</sup> -I and DPX <sup>3</sup> Shunt inrush power 300 VA
1	4 222 44	Colt voltage 24 V=
1	4 222 45	Colt voltage 24 V~
1	4 222 46	Colt voltage 48 V~ / =
1	4 222 47	Colt voltage 110 V~ / =
1	4 222 48	Colt voltage 230 V~ / =
1	4 222 49	Colt voltage 400 V~ / =
		<b>Automation control unit</b>
		Can control supply inversion between two circuit breakers, manage generator start / stop, control single-phase, two-phase and three-phase networks, control phase-phase voltages For DPX, DPX <sup>3</sup> and DMX <sup>3</sup> circuit breakers Power supply: 230 V~ or 12/24/48 V= Plug-in terminals
1	0 261 93	Standard unit
1	0 261 94	Communicating unit, enabling data transmission (RS 485 port)

Pack	Cat.Nos	Auxiliary power supply for DPX <sup>3</sup>
1	4 210 83	For supplying DPX <sup>3</sup> electronic units when the circuit breaker is open or when the current passing through it is insufficient Input voltage 24 V~ / = 2 modules Output 250 mA: can supply several circuit breakers Consumption: - Thermal-magnetic DPX <sup>3</sup> with residual current protection: 42 mA - Electronic DPX <sup>3</sup> : 30 mA - Electronic DPX <sup>3</sup> with measurement: 54 mA - Electronic DPX <sup>3</sup> with residual current protection: 54 mA - Electronic DPX <sup>3</sup> with residual current protection and measurement: 54 mA
		<b>RS485 Modbus communication interface</b>
		<b>DPX3 electronic interface</b>
1	4 210 75	For connecting thermal-magnetic DPX <sup>3</sup> with residual current protection and electronic DPX <sup>3</sup> to an RS485 Modbus communication network All the information managed by the circuit breaker's electronic card will be shared on the Modbus network Dimension: 2 modules Power supply: 24 V~ / = RS 485 link (2-wire) Address, speed and coding can be modified with configurator kit
		<b>Modular power supply</b>
	0 035 67	230 V~ - 27 V= - 0.6 A 2 modules
		<b>Communication and supervision</b>
		<b>Web servers</b>
		Enable remote viewing, via a web browser on PCs, smartphones, web viewers, tablet computers such as iPads, Archos, etc., of values collected on electricity meters and multi-function measuring units (p. 85)
1	0 261 78	For 32 metering points (meters or multi-function measuring units)
1	0 261 79	For an unlimited number of metering points (meters or multi-function measuring units)
		<b>Legrand Software</b>
		For displaying the values collected from electricity meters or multi-function measuring units on a PC connected to the network
1	0 261 88	For 32 metering points (supplied on CD)
1	0 261 89	For an unlimited number of metering points (supplied on CD)
		<b>Panel board display</b>
1	0 261 56	Allows to check information coming from different protection devices: DX <sup>3</sup> -HP, DPX <sup>3</sup> , DMX <sup>3</sup> or EMDX <sup>3</sup> Can manage up to 8 devices Power supply: 18-30 V= For mounting on door or solid faceplate Door cut: 96 x 96 mm

## Residual current relay and coils



Add residual current protection to DPX trip-free switches and DPX MCCBs equipped with release

Pack	Cat.Nos	Residual current relay	Number of modules
1	0 260 88	<p>Detects fault currents, and, when used with a shunt trip or an undervoltage release, it gives the trip command to a MCCB or a switch</p> <ul style="list-style-type: none"> <li>Comprises:                             <ul style="list-style-type: none"> <li>- a tinged, sealable window</li> <li>- an auxiliary contact</li> <li>- a green Led indicating energisation</li> <li>- 3 yellow Leds indicating respectively the max. phase earth insulation current: 20, 40 and 60 %</li> <li>- a red Led indicating</li> </ul> </li> <li>Fixed: exceeding of the insulation fault current value</li> <li>Flashing: breaking of one of the connections between coils and relays</li> <li>For use with coils:                             <ul style="list-style-type: none"> <li>- Ø35 and 80 mm</li> <li>Adjustable sensitivity: 0.03, 0.05, 0.075, 0.1, 0.15, 0.2, 0.3, 0.5, 0.75, 1, 1.5, 2, 3, 5, 7.5, 10, 15, 20, 30 A</li> <li>- Ø110 to 210 mm</li> <li>Adjustable sensitivity: 0.3, 0.5, 0.75, 1, 1.5, 2, 3, 5, 7.5, 10, 15, 20, 30 A</li> <li>- Ø150 mm</li> <li>Adjustable sensitivity: 0.5, 0.75, 1, 1.5, 2, 3, 5, 7.5, 10, 15, 20, 30 A</li> <li>- Ø300 mm</li> <li>Adjustable sensitivity: 1, 1.5, 2, 3, 5, 7.5, 10, 15, 20, 30 A</li> </ul> </li> <li>Adjustable trip: 0, 0.15, 0.25, 0.5, 1, 2.5, 5 seconds</li> <li>Supply voltage: 230/240 V - 50/60 Hz</li> </ul>	2
<b>Coils</b>			
1	0 260 92	Coil Ø35 mm	
1	0 260 93	Coil Ø80 mm	
1	0 260 94	Coil Ø110 mm	
1	0 260 95	Coil Ø140 mm	
1	0 260 96	Coil Ø210 mm	
1	0 260 97	Coil Ø150 mm - open	
1	0 260 98	Coil Ø300 mm - open	

## Residual current relay and coils

### Residual current relay

Cat.No 0 260 88

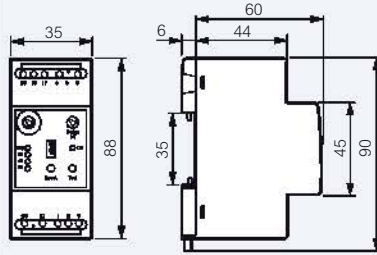

### Coils

Cat.Nos 0 260 92/93/94/95/96 Cat.No 0 260 97

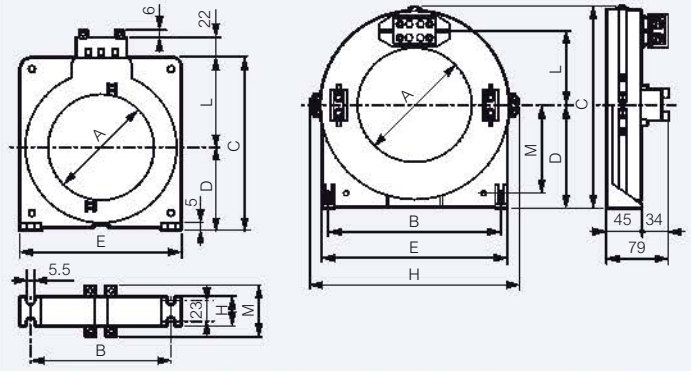

Cat.Nos	A	B	C	D	E	H	L	M
0 260 92	35	75	85	42	92	36	43	56
0 260 93	80	108	132	67	125	36	65	56
0 260 94	110	148	170	86	165	36	84	56
0 260 95	140	177	206	104	200	36	102	56
0 260 96	210	270	295	150	290	44	145	64
0 260 97	150	225	259	133	245	275	95	113

Cat.No 0 260 98

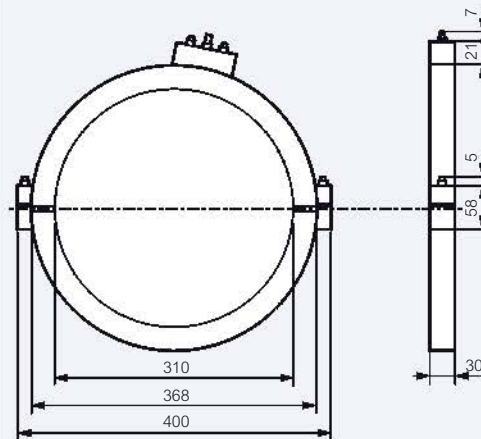

# Air circuit breakers DMX<sup>3</sup> 2500 and 4000

from 800 to 4000 A



0 286 56 + 0 288 02 (p. 141)



0 286 74 + 0 288 02 (p. 141)



0 287 56 + 0 288 02 (p. 141)

Dimensions **see e-catalogue**  
Electrical characteristics **see e-catalogue**

Automatic air circuit breakers must be equipped with electronic protection unit (p. 141), imperatively ordered together for factory assembly  
Please ask for DMX<sup>3</sup> order form

Pack	Cat.Nos	Fixed version	Pack	Cat.Nos	Draw-out version
		Supplied with - 4 auxiliary contacts: NO/NC - rear terminals for horizontal connection with bars - door sealing			Supplied with: - 4 auxiliary contacts: NO/NC - draw-out base and kit - flat rear terminals for connection with bars - door sealing
		<b>DMX<sup>3</sup> - N 2500</b> Breaking capacity Icu 50 kA (415 V <sub>~</sub> )			<b>DMX<sup>3</sup> - N 2500</b> Breaking capacity Icu 50 kA (415 V <sub>~</sub> )
		Frame 1			Frame 1
		3P   4P			3P   4P
1	0 286 21   0 286 31	800	1	0 287 21   0 287 31	800
1	0 286 22   0 286 32	1000	1	0 287 22   0 287 32	1000
1	0 286 23   0 286 33	1250	1	0 287 23   0 287 33	1250
1	0 286 24   0 286 34	1600	1	0 287 24   0 287 34	1600
1	0 286 25   0 286 35	2000	1	0 287 25   0 287 35	2000
1	0 286 26   0 286 36	2500	1	0 287 26   0 287 36	2500
		<b>DMX<sup>3</sup> - H 2500</b> Breaking capacity Icu 65 kA (415 V <sub>~</sub> )			<b>DMX<sup>3</sup> - H 2500</b> Breaking capacity Icu 65 kA (415 V <sub>~</sub> )
		Frame 1			Frame 1
		3P   4P			3P   4P
1	0 286 41   0 286 51	800	1	0 287 41   0 287 51	800
1	0 286 42   0 286 52	1000	1	0 287 42   0 287 52	1000
1	0 286 43   0 286 53	1250	1	0 287 43   0 287 53	1250
1	0 286 44   0 286 54	1600	1	0 287 44   0 287 54	1600
1	0 286 45   0 286 55	2000	1	0 287 45   0 287 55	2000
1	0 286 46   0 286 56	2500	1	0 287 46   0 287 56	2500
		<b>DMX<sup>3</sup> - L 2500</b> Breaking capacity Icu 100 kA (415 V <sub>~</sub> )			<b>DMX<sup>3</sup> - L 2500</b> Breaking capacity Icu 100 kA (415 V <sub>~</sub> )
		Frame 2			Frame 2
		3P   4P			3P   4P
1	0 286 61   0 286 71	800	1	0 287 61   0 287 71	800
1	0 286 62   0 286 72	1000	1	0 287 62   0 287 72	1000
1	0 286 63   0 286 73	1250	1	0 287 63   0 287 73	1250
1	0 286 64   0 286 74	1600	1	0 287 64   0 287 74	1600
1	0 286 65   0 286 75	2000	1	0 287 65   0 287 75	2000
1	0 286 66   0 286 76	2500	1	0 287 66   0 287 76	2500
		<b>DMX<sup>3</sup> - N 4000</b> Breaking capacity Icu 50 kA (415 V <sub>~</sub> )			<b>DMX<sup>3</sup> - N 4000</b> Breaking capacity Icu 50 kA (415 V <sub>~</sub> )
		Frame 2			Frame 2
		3P   4P			3P   4P
1	0 286 27   0 286 37	3200	1	0 287 27   0 287 37	3200
1	0 286 28   0 286 38	4000	1	0 287 28   0 287 38	4000
		<b>DMX<sup>3</sup> - H 4000</b> Breaking capacity Icu 65 kA (415 V <sub>~</sub> )			<b>DMX<sup>3</sup> - H 4000</b> Breaking capacity Icu 65 kA (415 V <sub>~</sub> )
		Frame 2			Frame 2
		3P   4P			3P   4P
1	0 286 47   0 286 57	3200	1	0 287 47   0 287 57	3200
1	0 286 48   0 286 58	4000	1	0 287 48   0 287 58	4000
		<b>DMX<sup>3</sup> - L 4000</b> Breaking capacity Icu 100 kA (415 V <sub>~</sub> )			<b>DMX<sup>3</sup> - L 4000</b> Breaking capacity Icu 100 kA (415 V <sub>~</sub> )
		Frame 2			Frame 2
		3P   4P			3P   4P
1	0 286 67   0 286 77	3200	1	0 287 67   0 287 77	3200
1	0 286 68   0 286 78	4000	1	0 287 68   0 287 78	4000

# Air circuit breakers DMX<sup>3</sup> 6300

5000 and 6300 A



0 289 51 + 0 288 02

Dimensions **see e-catalogue**  
 Electrical characteristics **see e-catalogue**

Automatic air circuit breakers must be equipped with electronic protection unit, imperatively ordered together for factory assembly  
 Please ask for DMX<sup>3</sup> order form

Pack	Cat.Nos		Fixed version
	Frame 3		Supplied with
			- 4 auxiliary contacts: NO/NC
			- rear terminals for horizontal connection with bars
			- door sealing
			<b>DMX<sup>3</sup> - L 6300</b>
			Breaking capacity Icu 100 kA (415 V~)
			In(A)
1	3P	4P	5000
1	0 289 50	0 289 60	
1	0 289 51	0 289 61	6300
	Frame 3		Supplied with:
			- 4 auxiliary contacts: NO/NC
			- draw-out base and kit
			- flat rear terminals for connection with bars
			- door sealing
			<b>DMX<sup>3</sup> - L 6300</b>
			Breaking capacity Icu 100 kA (415 V~)
			In(A)
1	3P	4P	5000
1	0 289 52	0 289 62	
1	0 289 53	0 289 63	6300

# Electronic protection units for DMX<sup>3</sup>



0 288 02



0 288 03

Settings and curves **see e-catalogue**

DMX<sup>3</sup> circuit breakers must be equipped with electronic protection units (to be ordered together for factory assembly) enabling very precise adjustments of the protection conditions, while maintaining total discrimination with downstream devices  
 All protection units are equipped with batteries for powering in case of mains fault or when the breaker is open or not connected

Pack	Cat.Nos	MP4 protection units with LCD screen
		Integrated LCD screen for displaying electrical values, settings and log Adjustment via selector switches
		<b>LI protection unit</b> Adjustment of: li, Ir, tr
1	0 288 00	
		<b>LSI protection unit</b> Adjustment of: Isd, tsd, Ir, tr and li
1	0 288 01	
		<b>LSIg protection unit</b> Adjustment of: Isd, tsd, Ir, tr, li, Ig and tg
1	0 288 02	
		<b>MP6 touch screen protection units</b> Measure and display instantaneous, maximum and average values of different electrical values and protection conditions Fault signalling and log
		<b>LSI protection unit</b> Adjustment of: Isd, tsd, Ir, tr and li
1	0 288 03	
		<b>LSIg protection unit</b> Adjustment of: Isd, tsd, Ir, tr, li, Ig and tg
1	0 288 04	
		<b>Accessories for electronic protection units</b>
1	0 288 05 <sup>1</sup>	Communication option for DMX <sup>3</sup> electronic protection units
1	0 288 06	24 V DC external auxiliary power supply
1	0 288 10 <sup>1</sup>	External neutral for DMX <sup>3</sup> 6300
1	0 288 11 <sup>1</sup>	External neutral for DMX <sup>3</sup> 2500 and 4000
1	0 288 12 <sup>1</sup>	Module programmable output

1: Optional accessories, to be ordered when ordering electronic protection unit and DMX<sup>3</sup> air circuit breakers for factory assembly

For detailed dimensions of DMX<sup>3</sup> range, **see e-catalogue**



# Trip free switches DMX<sup>3</sup>-I

from 1250 to 6300 A



0 286 96



0 287 96

Dimensions [see e-catalogue](#)

Pack	Cat.Nos	Fixed version
		Supplied with: - 4 auxiliary contacts: NO/NC - flat rear terminals for connection with bars - door sealing
		<b>DMX<sup>3</sup>-I 2500</b>
		In (A)
	Frame 1	
	3P   4P	
1	0 286 83   0 286 93	1250
1	0 286 84   0 286 94	1600
1	0 286 85   0 286 95	2000
1	0 286 86   0 286 96	2500
	Frame 2	<b>DMX<sup>3</sup>-I 4000</b>
		In (A)
	3P   4P	
1	0 286 87   0 286 97	3200
1	0 286 88   0 286 98	4000
	Frame 3	<b>DMX<sup>3</sup>-I 6300</b>
		In (A)
	3P   4P	
1	0 289 70   0 289 71	6300

Pack	Cat.Nos	Draw-out version
		Supplied with: - 4 auxiliary contacts: NO/NC - draw-out base and kit - flat rear terminals for connection with bars - door sealing
		<b>DMX<sup>3</sup>-I 2500</b>
		In (A)
	Frame 1	
	3P   4P	
1	0 287 83   0 287 93	1250
1	0 287 84   0 287 94	1600
1	0 287 85   0 287 95	2000
1	0 287 86   0 287 96	2500
	Frame 2	<b>DMX<sup>3</sup>-I 4000</b>
		In (A)
	3P   4P	
1	0 287 87   0 287 97	3200
1	0 287 88   0 287 98	4000
	Frame 3	<b>DMX<sup>3</sup>-I 6300</b>
		In (A)
	3P   4P	
1	0 289 77   0 289 78	6300

For detailed dimensions of DMX<sup>3</sup>-I range, [see e-catalogue](#)



# Trip free switches DMX<sup>3</sup>-I

from 1250 to 6300 A

## Technical characteristics

Trip free switch DMX <sup>3</sup> -I	2500	4000	6300
Frame	1	2	3
Rating I <sub>n</sub> à 40° C (A)	1250 1600 2000 2500	3200 4000	6300
Rated insulation voltage U <sub>i</sub> (V)	1000	1000	1000
Rated impulse withstand voltage U <sub>imp</sub> (kV)	12	12	12
Rated operational voltage (50/60Hz) U <sub>e</sub> (V)	690	690	690
Isolation behaviour	Yes	Yes	Yes
Short-circuit making capacity I <sub>cm</sub> (kA)	230 V~	143	220
	415 V~	143	220
	500 V~	143	220
	600 V~	132	165
	690 V~	121	143
Short time withstand current I <sub>cw</sub> (kA) pour t = 1 s	230 V~	65	85
	415 V~	65	85
	500 V~	65	85
	600 V~	60	75
	690 V~	55	65
Endurance (cycles)	mechanical	10000	10000
	electrical	5000	5000
Temperature	operation	-5°C to +70°C	-5°C to +70°C
	storage	-25°C to +85°C	-25°C to +85°C

## Temperature derating

### Fixed version

	Temperature									
	40°C		50°C		60°C		65°C		70°C	
	I <sub>max</sub> (A)	I <sub>r</sub> / I <sub>n</sub>	I <sub>max</sub> (A)	I <sub>r</sub> / I <sub>n</sub>	I <sub>max</sub> (A)	I <sub>r</sub> / I <sub>n</sub>	I <sub>max</sub> (A)	I <sub>r</sub> / I <sub>n</sub>	I <sub>max</sub> (A)	I <sub>r</sub> / I <sub>n</sub>
DMX <sup>3</sup> -I 2500	1250	1	1250	1	1250	1	1250	1	1250	1
	1600	1	1600	1	1600	1	1600	1	1600	1
	2000	1	2000	1	1960	0.98	1920	0.96	1880	0.94
	2500	1	2450	0.98	2350	0.94	2250	0.9	2150	0.86
DMX <sup>3</sup> -I 4000	3200	1	3200	1	3200	1	3136	0.98	3008	0.94
	4000	1	3920	0.98	3680	0.92	3440	0.86	3120	0.78
DMX <sup>3</sup> -I 6300	6300	1	6300	1	6048	0.96	5796	0.92	5544	0.88

### Draw-out version

	Temperature									
	40°C		50°C		60°C		65°C		70°C	
	I <sub>max</sub> (A)	I <sub>r</sub> / I <sub>n</sub>	I <sub>max</sub> (A)	I <sub>r</sub> / I <sub>n</sub>	I <sub>max</sub> (A)	I <sub>r</sub> / I <sub>n</sub>	I <sub>max</sub> (A)	I <sub>r</sub> / I <sub>n</sub>	I <sub>max</sub> (A)	I <sub>r</sub> / I <sub>n</sub>
DMX <sup>3</sup> -I 2500	1250	1	1250	1	1250	1	1250	1	1250	1
	1600	1	1600	1	1600	1	1600	1	1600	1
	2000	1	2000	1	1960	0.98	1920	0.96	1875	0.94
	2500	1	2400	0.96	2250	0.9	2100	0.84	1950	0.78
DMX <sup>3</sup> -I 4000	3200	1	3200	1	3200	1	3072	0.96	2880	0.9
	4000	1	3760	0.94	3440	0.86	3200	0.8	2960	0.74
DMX <sup>3</sup> -I 6300	6300	1	6174	0.98	5985	0.95	5796	0.92	5292	0.84



## Auxiliaries and accessories for DMX<sup>3</sup>

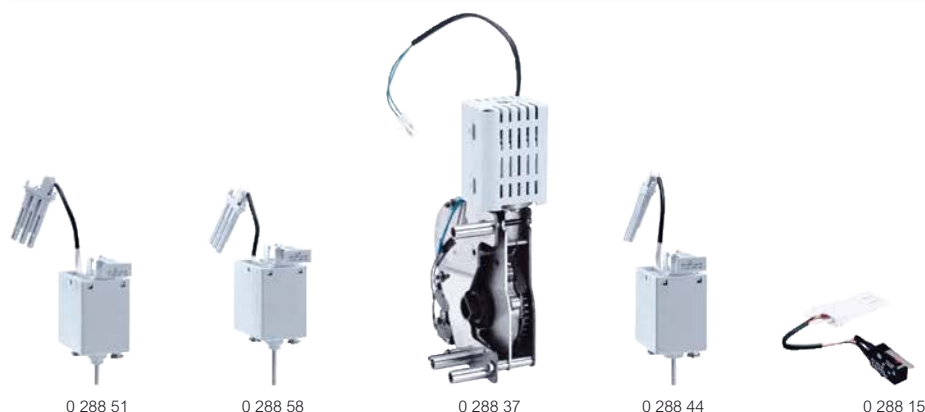

Pack	Cat.Nos	Control and signalling auxiliaries
		<b>Shunt trip</b>
		When energised the circuit breaker will be tripped
1	0 288 48	24 V~/=
1	0 288 49	48 V~/=
1	0 288 50	110 - 130 V~/=
1	0 288 51	220 - 250 V~/=
1	0 288 52	415 - 480 V~
		<b>Undervoltage releases</b>
		When the coil is de-energised, the circuit breaker will be tripped
1	0 288 55	24 V~/=
1	0 288 56	48 V~/=
1	0 288 57	110 - 130 V~/=
1	0 288 58	220 - 250 V~/=
1	0 288 59	415 - 480 V~
		<b>Module for delayed tripping</b>
		To be used with above undervoltage releases
1	0 288 62	110 V~/=
1	0 288 63	230 V~/=
		<b>Motor operators</b>
		To motorize a DMX, it is possible to attach, to the motor operators, a release coil (undervoltage or trip on energising) and a closing coil
1	0 288 34	24 V~/=
1	0 288 35	48 V~/=
1	0 288 36	110 - 130 V~/=
1	0 288 37	220 - 250 V~/=
1	0 288 38	415 - 440 V~
1	0 288 40	480 V~/=
		<b>Closing coils</b>
		Enables remote closing of the circuit breaker if the closing spring is charged
1	0 288 41	24 V~/=
1	0 288 42	48 V~/=
1	0 288 43	110 - 130 V~/=
1	0 288 44	220 - 250 V~/=
1	0 288 45	415 - 480 V~
1	0 288 16	<b>Signalling contact for auxiliaries</b> Signalling contact for shunt trips, undervoltage releases and closing coils
1	0 288 13	<b>Signalling contact for draw-out version</b> Inserted / test / draw-out signalling contact 3 changeover contacts per position

Pack	Cat.Nos	Locking
		<b>Key locking in "open" position</b>
1	0 288 30	Lock and star key N° HBA90GPS6149 - to be fitted on the frame Cat.No 0 288 28
1	0 288 31	Lock and flat key N° ABA90GEL6149 - to be fitted on the frame Cat.No 0 288 28
1	0 288 28	2 hole support frame for locks Cat.Nos 0 288 30/31
1	0 288 29	Set of 5 key barrels with flat key
		<b>Key locking in the draw-out position</b>
		Mounting of the lock on the base
1	0 288 32	Lock and star key N° HBA90GPS6149
1	0 288 33	Lock and flat key N° ABA90GEL6149
		<b>Door locking</b>
		Prevents opening of the door with the circuit breaker closed
1	0 288 20	Left-hand and right-hand side mounting
		<b>Padlocks in "open" position</b>
1	0 288 21	Padlocking system for ACB (padlock not supplied)
1	0 288 24	Padlock for buttons
1	0 288 26	Padlocking system for shutters (padlock not supplied)
		<b>Equipment for conversion of a fixed device into draw-out device</b>
		<b>Bases for draw-out device</b>
		For DMX <sup>3</sup> /DMX <sup>3</sup> -I frame 1
1	0 289 02	0 289 03
1	0 289 04	0 289 05
1	0 289 13	0 289 14
		For DMX <sup>3</sup> /DMX <sup>3</sup> -I frame 2
		For DMX <sup>3</sup> /DMX <sup>3</sup> -I frame 3
		<b>Transformation kit for draw-out version</b>
1	0 289 09	0 289 10
1	0 289 11	0 289 12
1	0 289 15	0 289 16
		For DMX <sup>3</sup> /DMX <sup>3</sup> -I frame 1
		For DMX <sup>3</sup> /DMX <sup>3</sup> -I frame 2
		For DMX <sup>3</sup> /DMX <sup>3</sup> -I frame 3
		<b>Accessories</b>
1	0 288 25	Rating mis-insertion device Prevents the insertion of a draw-out circuit breaker in an incompatible base
1	0 288 23	Operations counter Counts total number of operation cycles of the device
1	0 288 14	Contact "ready to close" with charged springs
1	0 288 15	Additional signalling contact
1	0 288 79	Lifting plate

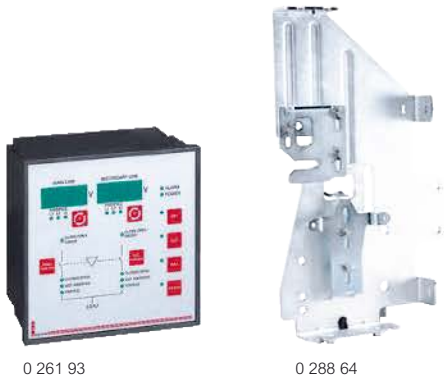

Technical characteristics **see e-catalogue**

Dimensions **see e-catalogue**

Pack	Cat.Nos	Automation control unit
1	0 261 93	Can control supply inversion between two circuit breakers, manage generator start / stop, control single-phase, two-phase and three-phase networks, control phase-phase voltages For DPX, DPX <sup>3</sup> and DMX <sup>3</sup> circuit breakers Power supply : 230 V~ or 12/24/48 V=
1	0 261 94	Plug-in terminals Standard unit Communicating unit, enabling data transmission (RS 485 port)
<b>Equipment for supply invertors</b>		
1	0 288 64	The mechanical interlock is set up using cables and can interlock 2 or 3 devices, which may be different type in a vertical or horizontal configuration The interlock unit is mounted on the right-hand side of the device Cable interlock to be ordered separately (cable length to be specified according to every configuration - see below)
1	0 288 65	Interlock for DMX <sup>3</sup> frame 1
1	0 288 66	Interlock for DMX <sup>3</sup> frame 2
<b>Cable interlock</b>		
1	0 289 20	Type 1 (2600 mm)
1	0 289 21	Type 2 (3000 mm)
1	0 289 22	Type 3 (3600 mm)
1	0 289 23	Type 4 (4000 mm)
1	0 289 24	Type 5 (4600 mm)
1	0 289 25	Type 6 (5600 mm)

Pack	Cat.Nos		Rear terminals
1	3P 0 288 84	4P 0 288 85	<b>For DMX<sup>3</sup> frame 1 fixed version</b> For flat connection with bars To be fixed onto horizontal rear terminals of the circuit breaker
1	0 288 82	0 288 83	For vertical connection with bars Those terminals are used in order to transform a flat connection into a vertical one To be fixed onto Cat.Nos 0 288 84/85 according to the number of poles
1	0 288 96	0 288 97	<b>For DMX<sup>3</sup> frame 1 draw-out version</b> For vertical or horizontal connection with bars To be fixed onto plate rear terminals of the circuit breaker
1	0 288 92	0 288 93	<b>For DMX<sup>3</sup> frame 2 and 3 fixed version</b> For flat connection with bars To be fixed onto horizontal rear terminals of the circuit breaker 2 sets are required for frame 3
1	0 288 94	0 288 95	<b>For DMX<sup>3</sup> frame 2 and 3 fixed or draw-out version</b> On DMX <sup>3</sup> fixed version: - For vertical connection with bars - To be fixed onto Cat.Nos 0 288 92/93 according to the number of poles On DMX <sup>3</sup> draw-out version: - For vertical or horizontal connection with bars - To be fixed directly onto plate rear terminals of the circuit breaker 2 sets are required for frame 3
1	3P 0 288 86	4P 0 288 87	<b>Spreaders for DMX<sup>3</sup> frame 1 fixed version</b> To be fixed onto horizontal rear terminals of the circuit breaker
1	0 288 88	0 288 89	For flat connection with bars
1	0 288 90	0 288 91	For vertical connection with bars For horizontal connection with bars

## Supply invertors equipment for DMX<sup>3</sup>

### Mounting of interlock unit

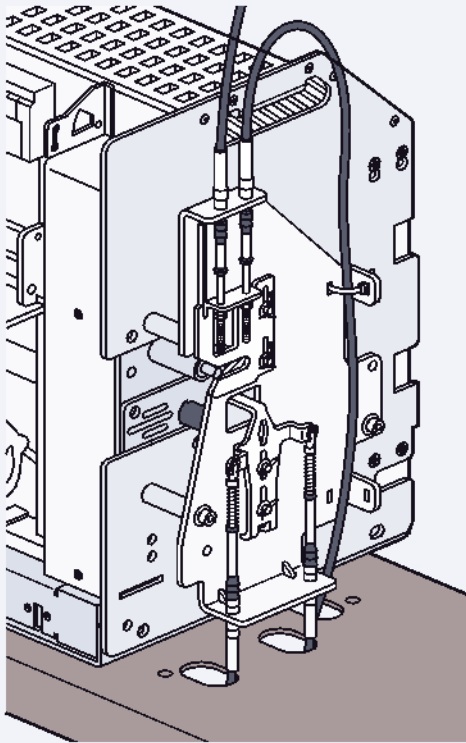

### Choice of cable interlock

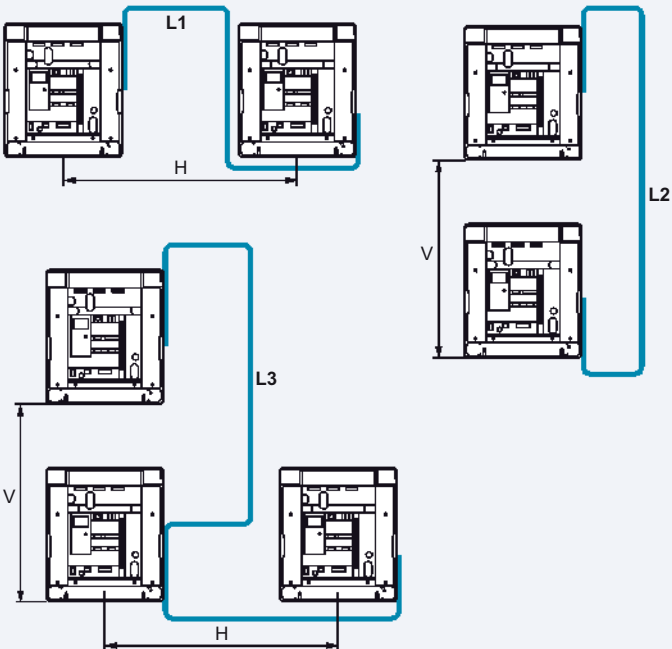

Calculation of cable length:

$$L1 = 1430 + H$$

$$L2 = 1570 + V$$

$$L3 = 1430 + V + H$$

### Functions

#### Standard unit Cat.No 0 261 93

Used to adjust and manage the source inversion operating conditions (DMX<sup>3</sup>):

- Remote control (opening/closing) of MCBs
- Microprocessor output from unit (positive safety)
- Programmable I/O
- Voltage reading: 3-phase
  - phase-neutral
  - phase-phase
- Control (on/off) of generator set
- Indication of the state of the MCBs (open/closed/tripped)
- Source inversion blocked in the event of:
  - Tripping of 1 or 2 devices
  - If a draw-out ACB is not inserted in its base, as the open/close command of the unit is inoperative

#### Communicating unit Cat.No 0 261 94

All the standard functions, plus:

- Maximum voltage reading
- Reading of phase rotation direction
- Frequency reading
- Communication: data transmission via the RS 485 port (Modbus protocol)

### Technical characteristics

Power supply: 187 to 264 V $\sim$   
9 to 65 V $\equiv$

Frequency: 45 to 65 Hz

Un: 80 to 690 V $\sim$

Control relay (1 and 4): 1 NO - 12 A - 250 V $\sim$

1 NO - 5 A - 250 V $\sim$

1 NO/NC - 5 A - 250 V $\sim$

Cable cross-section: 0.2 to 2.5 mm<sup>2</sup>

Dimensions (width x height x depth): 144 x 144 x 90 mm

Protection: IP 20 at the rear

IP 41 at the front

IP 54 at the front with protective screen

Operating temperature: - 20 °C to + 60 °C

	Operating ranges
Main/secondary minimum voltage range	70-98 % Un
Main/secondary voltage absence range	60-85 % Un
Main/secondary minimum voltage delay	0.1-900 s
Main/secondary voltage absence delay	0.1-30 s
Generator operating delay	0-900 s
Main to secondary switching delay	0.1-90 s
Main line presence delay	1-3600 s
Secondary to main switching delay	0.1-90 s
Generator set stopping delay	1-3600 s

### Dimensions and panel board faceplate cut-out

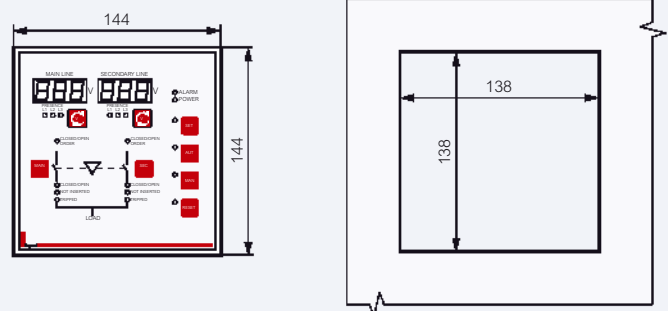

# Vistop™ isolating switches

32 to 160 A



0 225 05



0 225 15

Safety switches for on-load circuit breaking by visible isolation of the contacts  
 Double break type load switching with self cleaning contacts by rapid make and break movements  
 Fixing on rail EN 60715 or screw fixing (only on rail for Vistop 63 A)  
 Padlockable handle in open position: 1 to 3 padlocks Cat.No 0 227 97 (p. 61)  
 2 versions for mounting on faceplate:  
 • right side handle, supplied with seal to maintain the IP protection for the enclosures (up to IP 55), screws, self adhesive drilling template, extension rod (30 to 170 mm) for creating an external angle  
 • direct front handle or external (for Vistop 63 to 160 A)

Pack	Cat.Nos		32 A	Connection	No of 17.5 mm modules
	Front handle	Side handle			
1	0 224 98	0 225 03	2P	16 mm <sup>2</sup> cage terminals	4 + 3.5
1	0 225 00	0 225 05	3P		4 + 3.5
1	0 225 02	0 225 07	4P		5 + 4.5

## 63 to 160 A

Possibility to add auxiliary contact  
 Cat.No 0 227 07

Pack	Front handle	Side handle	63 A	Connection	No of 17.5 mm modules
1	0 225 12	0 225 16	3P	cage terminals	7
1	0 225 15	0 225 18	4P		7
1	0 225 20	0 225 25	3P	key	7.5
1	0 225 22	0 225 27	4P		9
1	0 225 34	0 225 44	3P	key	7.5
1	0 225 39	0 225 46	4P		9
1	0 225 51	0 225 54	3P	key	7.5
1	0 225 53	0 225 56	4P		9

## Accessories

### Front external handle for Vistop 63 to 160 A

Comprising: connection rod, bracket, self-adhesive drilling template, fixing accessories (including a seal to maintain the IP protection of enclosure up to IP 55) and locking mechanism to prevent opening of the door when the circuit is closed  
 Door distance 35 to 470 mm

### Auxiliary signalling contacts

IP 2X - 5 A - 250 V  
 To be fitted inside Vistop isolating switches  
 Main contact NO + NC  
 Additional contact NO + NC  
 To be fitted on main contact  
 Cat.No 0 227 04 in order to obtain 2 NO + 2 NC

Pack	Cat.No	Connection (mm <sup>2</sup> )
1	0 227 04	lug 2.58
1	0 227 07	lug 2.58

For detailed dimensions, see e-catalogue



# Vistop™ isolating switches

32 to 160 A

Conform to standards EN / IEC 60947-3, BS EN 60947-3, VDE 0660, NBN EN 60947-3, CNOMO E03 - 15-611 R, Veritas approved  
 Glass fibre reinforced insulating casing, self-extinguishing at 960 °C (IEC EN 60695-2-1)  
 Handle can be padlocked in open position using 1 to 3 padlocks Ø6 mm

## Electrical characteristics

Thermal rating (Ith)	32 A	63 A	100 A	125 A	160 A	
Terminals	cage	cage	cage	cage	cage	
Connection	Cu (flexible) 4 to 35 <sup>2</sup>		4 to 35 <sup>2</sup>			
	Cu (rigid) 4 to 50 <sup>2</sup>		4 to 70 <sup>2</sup>			
Insulating voltage (Ui)	690 V~	690 V~	690 V~	690 V~	800 V~	
Impulse resistant voltage (Uimp)	8 kV	8 kV	8 kV	8 kV	8 kV	
AC 22 A <sup>(1)</sup>	400 V	32 A (17 kW)	63 A (35 kW)	100 A (55 kW)	125 A (70 kW)	160 A (88 kW)
	500 V	32 A (20 kW) <sup>(2)</sup> 20 A (14 kW)	63 A (44 kW)	100 A (69 kW)	125 A (87 kW)	160 A (110 kW)
AC 23 A <sup>(1)</sup>	690 V	-	40 A (38 kW)	100 A (96 kW)	125 A (120 kW)	125 A (120 kW)
	DC 22 A/250 V <sup>(1)(3)</sup>	*	100	125	125	
DC 23 A/250 V <sup>(1)(3)</sup>	*	100	125	125		
Breaking capacity (Icu) (kA peak)	5	15	15	15	15	
1 s resistant current (Icw) (kA rms)	0.5	2.5	3.5	3.5	3.5	
Icc with fuses (kA rating)	100	100	100	100	80	
Fuse rupture capacity	32 A (gG) 20 A (aM)	63 A	100 A (gG) 63 A (aM) <sup>(4)</sup>	125 A (gG) 125 A (aM) <sup>(4)</sup>	160 A (gG) 125 A (aM)	
Short circuit capacity (kA prospective peak) (Icm)	0.75	7	12	12	12	
Mechanical endurance (No of operations)	> 10000	> 30000	> 30000	> 30000	> 30000	
Index of protection	IP 2X (16 mm <sup>2</sup> IP 3X under front plate)		IP 2X B (IP 3X C under front plates) from 6 mm <sup>2</sup>		IP 2X B (IP 3X C under front plate) from 10 mm <sup>2</sup>	

## Example of mounting with Vistop 100 to 160 A

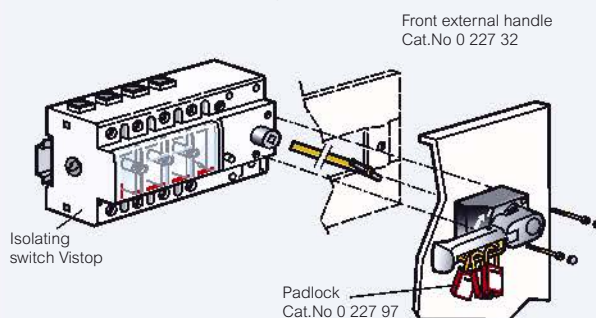

1: Test according to IEC 60947-3  
 AC 22 A / DC 22 A: resistive motor breaking  
 AC 23 A / DC 23 A: inductive motor breaking  
 2: 32 A (20 kW) for AC 22 A  
 20 A (14 kW) for AC 23 A  
 3: No of breaking contacts: 2  
 4: 100 A (aM) with blade type cartridge fuses

# DPX™-IS 250 isolating switches

63 to 250 A



Dimensions **see e-catalogue**  
Electrical characteristics **p. 150**

Isolating switches for on-load circuit breaking by visible isolation and positive action of the contacts

Padlock integrated in the handle

Connection with cage terminals

Supplied with terminal shields

Conform to IEC 60947-3

Category of use AC 23 A

Accept electrical auxiliaries (p. 149)

Can be mounted on rail or on plate in XL<sup>3</sup> enclosures

Pack	Cat.Nos		DPX-IS with release
	3P	4P	Can be associated with a residual current relay with separate coils (p. 139), supplied without shunt trip
1	0 266 30	0 266 34	<b>Front handle</b>
1	0 266 31	0 266 35	63 A
1	0 266 32	0 266 36	100 A
1	0 266 33	0 266 37	160 A
			<b>Right-hand side handle</b>
1	0 266 40	0 266 44	63 A
1	0 266 41	0 266 45	100 A
1	0 266 42	0 266 46	160 A
1	0 266 43	0 266 47	250 A
			<b>Left-hand side handle</b>
1	0 266 50	0 266 54	63 A
1	0 266 51	0 266 55	100 A
1	0 266 52	0 266 56	160 A
1	0 266 53	0 266 57	250 A

Pack	Cat.Nos		DPX-IS without release
	3P	4P	
1	0 266 02	0 266 06	<b>Front handle</b>
1	0 266 03	0 266 07	160 A
			<b>Right-hand side handle</b>
1	0 266 12	0 266 16	160 A
1	0 266 13	0 266 17	250 A
			<b>Left-hand side handle</b>
1	0 266 22	0 266 26	160 A
1	0 266 23	0 266 27	250 A

Pack	Cat.Nos	Mounting on rail
1	0 262 39	<b>Rail  fixing plate</b> For DPX-IS 250

Pack	Cat.Nos	Rotary handles
1	0 266 89	<b>Direct for emergency use</b> For mounting instead of standard handle
1	0 266 90	Front and right-hand side handle Left-hand side handle
		<b>Vari-depth handle IP 55</b> Comprising: connecting rod, bracket, self-adhesive drilling template, fixing accessories (seal to maintain the IP protection up to IP 55, door lock mechanism)
1	0 266 86	For front and side handle device
1	0 266 87	For front and side handle device for emergency use To be ordered with Cat.Nos 0 266 89 or 0 266 90

Pack	Cat.Nos	Accessories
1	0 262 88 <sup>1</sup>	<b>Cage terminals</b> Set of 4 For cable 185 mm <sup>2</sup> (rigid) or 150 mm <sup>2</sup> (flexible) for DPX 250 ER and DPX-IS 250
1	0 273 22	<b>Spreaders</b> Set of upstream and downstream spreaders
		<b>Rear terminals</b> Used to convert the fixed version with front terminals to the fixed version with rear terminals
1	0 265 10   0 265 11	3P   4P Set of upstream and downstream rear terminals
1	0 262 87	<b>Terminal shields</b> Set of 2
1	0 266 92	<b>Padlock</b> For locking mechanism in open position (factory assembled) Padlock with flat key N° ABA90GEL6149
1	0 266 94	<b>Interlock</b> Provides closing of 2 devices at the same time (factory assembled)

<sup>1</sup>: Can not be mounted on side by side mounted earth leakage modules 160 A

For detailed dimensions, **see e-catalogue**



XL<sup>3</sup> mounting accessories, **p. 206, 217, 227**



# DPX™-IS 630 isolating switches

400 to 630 A



0 266 62



0 266 70



0 262 50



0 262 51

Dimensions **see e-catalogue**  
Electrical characteristics **p. 150**

Isolating switches for on-load circuit breaking by visible isolation and positive action of the contacts

Padlock integrated in the handle

Supplied with terminal shields, and cage terminals

Conform to IEC 60947-3

Category of use AC 23 A

Accept electrical auxiliaries (p. 149)

Can be mounted on plate in XL<sup>3</sup> enclosures

Pack	Cat.Nos		<b>DPX-IS with release</b>
	3P	4P	Can be associated with a residual current relay with separate coil (p. 139), supplied without shunt trip
1	0 266 72	0 266 74	<b>Front handle</b>
1	0 266 73	0 266 75	400 A
			630 A
			<b>Right-hand side handle</b>
1	0 266 76	0 266 78	400 A
1	0 266 77	0 266 79	630 A
			<b>Left-hand side handle</b>
1	0 266 80	0 266 82	400 A
1	0 266 81	0 266 83	630 A
			<b>DPX-IS without release</b>
	3P	4P	<b>Front handle</b>
1	0 266 60	0 266 62	400 A
1	0 266 61	0 266 63	630 A
			<b>Right-hand side handle</b>
1	0 266 64	0 266 66	400 A
1	0 266 65	0 266 67	630 A
			<b>Left-hand side handle</b>
1	0 266 68	0 266 70	400 A
1	0 266 69	0 266 71	630 A
			<b>Rotary handles</b>
			<b>Direct for emergency use</b>
1	0 266 89		For mounting instead of standard handle
1	0 266 90		Front and right-hand side handle
			Left-hand side handle
			<b>Vari-depth handle IP 55</b>
			Comprising: connecting rod, bracket, self-adhesive drilling template, fixing accessories (seal to maintain the IP protection up to IP 55, door lock mechanism)
1	0 266 86		For front and side handle device
1	0 266 87		For front and side handle device for emergency use
			To be ordered with Cat.Nos 0 266 89 or 0 266 90

Pack	Cat.Nos		<b>Accessories</b>
1	0 262 50		<b>Cage terminals</b>
			Set of 4 terminals for cable 300 mm <sup>2</sup> max. (rigid) or 240 mm <sup>2</sup> max. (flexible)
1	0 262 51		Set of 4 high-capacity terminals for cable 2 x 240 mm <sup>2</sup> (rigid) or 2 x 185 mm <sup>2</sup> (flexible)
	3P	4P	<b>Spreaders</b>
1	0 262 48	0 262 49	Set of incoming or outgoing spreaders
			<b>Rear terminals</b>
			Used to convert the fixed version with front terminals to the fixed version with rear terminals
1	0 263 50	0 263 51	Set of incoming and outgoing swivel rear terminals
1	0 263 52	0 263 53	Set of incoming and outgoing flat rear terminals
			<b>Sealable terminal shields</b>
1	0 262 45		Set of 2
			<b>Padlock</b>
1	0 266 97		For locking mechanism in open position Padlock with flat key N° ABA90GEL6149



# DPX™-IS 1600 isolating switches

800 to 1600 A



0 265 98



0 262 65

Dimensions **see e-catalogue**  
Electrical characteristics **p. 150**

Isolating switches for on-load circuit breaking by visible isolation and positive action of the contacts  
Connection with cage terminals  
Padlock integrated in the handle  
Supplied with terminal shields  
Conform to IEC 60947-3  
Category of use AC 23 A  
Accept electrical auxiliaries (opposite)  
Can be mounted on plate in XL<sup>3</sup> enclosures

Pack	Cat.Nos		DPX-IS with release
1	3P	4P	Can be associated with a residual current relay with separate coil (p. 139), supplied without shunt release
1	0 265 91	0 265 95	<b>Front handle</b>
1	0 265 92	0 265 96	800 A
1	0 265 93	0 265 97	1000 A
1	0 265 94	0 265 98	1250 A
1			1600 A
1	0 265 89		<b>Van-depth handle</b>
1	0 265 90		Standard For emergency use
1	0 262 93		<b>Locking accessories</b>
1	0 262 94		Key barrel and flat key N° ABA90GEL6149 Key barrel and star key N° HBA90GPS6149
1	0 262 69		<b>Accessories</b>
1	0 262 69		<b>Cage terminals</b> Set of 1 terminal for cables without lug 2 x 240 mm <sup>2</sup> for rigid cable or 2 x 185 mm <sup>2</sup> for flexible cable
1	0 262 70		Set of 1 high-capacity terminal for cables without lug 4 x 240 mm <sup>2</sup> for rigid cable 2 x 185 mm <sup>2</sup> for flexible cable
1	3P	4P	<b>Spreaders</b>
1	0 262 73	0 262 74	Set of incoming or outgoing spreaders
1	0 263 80		<b>Rear terminals</b>
1	0 263 81		Used to convert the fixed version with front terminals to the fixed version with rear terminals
1	0 263 82		Set of incoming and outgoing rear terminals
1	0 263 83		Short terminals
1	0 262 67		Long terminals
1	0 262 68		<b>Extended front terminals</b>
1	0 262 67		Short terminals for 630 - 1250 A (2 bars max. per pole)
1	0 262 68		Long terminals for 1600 A (3 bars max. per pole)
1	3P	4P	<b>Sealable terminal shields</b>
1	0 262 64	0 262 65	Set of 2
1	0 262 66		<b>Insulation shields</b> Used to isolate the connections between each pole Set of 3

# DPX™-IS auxiliaries



0 261 60



0 261 85

Pack	Cat.Nos		Auxiliary contact or fault signal
1	0 261 60		For signalling the state of the contacts or opening of the MCCB on a fault For DPX Changeover switch 3 A - 240 V~
1	0 261 64		<b>Releases</b>
1	0 261 65		Allow remote tripping of a DPX-IS
1	0 261 66		<b>Shunt releases</b>
1	0 261 67		Shunt inrush power 300 VA
1	0 261 68		Coil voltage 24 V~/=
			Coil voltage 48 V~/=
			Coil voltage 110 V~/=
			Coil voltage 230 V~/=
			Coil voltage 400 V~/=
			<b>Undervoltage releases</b>
			Undervoltage power consumption 5 VA
			Coil voltage 24 V=
			Coil voltage 24 V~
			Coil voltage 48 V~/=
			Coil voltage 110 V~/=
			Coil voltage 230 V~/=
			Coil voltage 400 V~/=
			<b>Time-lag (ms) undervoltage releases</b>
			Allow remote tripping of a DPX-IS
			Prevent false tripping in the event of AC supply microbreaks
			Require a time-lag module connected to the undervoltage releases below
			Time-lag modules 230 V~ 3
			Time-lag modules 400 V~ 3
			Undervoltage releases
			For DPX-IS 250, 630
			Undervoltage releases
			For DPX-IS 1600

For detailed dimensions, **see e-catalogue**



# DPX™-IS isolating switches

63 to 1600 A

## Electrical characteristics

### DPX-IS 250

Rating		63 A	100 A	160 A	250 A
Connection	Cu flexible	150 mm <sup>2</sup>			
	Cu rigid / Alu	185 mm <sup>2</sup>			
Copper bar		Width max. 28 mm			
Nominal rating (Ue)		690 V~ - 250 V=			
Rated insulation voltage (Ui)		800 V~			
Rated impulse withstand voltage (Uimp)		8 kV~			
AC 23 A	400 V~	63 A	100 A	160 A	250 A
	500 V~	63 A	100 A	160 A	250 A
	690 V~	63 A	100 A	160 A	250 A
AC 22 A	690 V~	63 A	100 A	160 A	250 A
Short-circuit making capacity (kA efficient) (Icm)		40 kA			
I admissible Is (Icw)		12 kA efficient			
I admissible with fuse (Icc)		100 kA efficient			
Max. rating of fuse	gG	63 A	100 A	160 A	250 A
	aM	63 A	100 A	160 A	160 A
Rated closing capacity on short circuit (kA peak) (Icm)		40 kA			
Endurance (cycles)	mechanical	25000 operations			
	electrical (AC 23 - 400 V~)	2500 operations			
Index of protection		IP 20 front panel			

### DPX-IS 1600

Rating		800 A	1000 A	1250 A	1600 A
Connection	Cu flexible	2 x 185 mm <sup>2</sup> or 4 x 185 mm <sup>2</sup>			
	Cu rigid / Alu	2 x 240 mm <sup>2</sup> or 4 x 240 mm <sup>2</sup>			
Copper bar/lugs		50 mm or 80 mm			
Nominal rating (Ue)		690 V~			
Rated insulation voltage (Ui)		690 V~			
Rated impulse withstand voltage (Uimp)		8 kV~			
AC 23 A	400 V~	800 A	1000 A	1250 A	1600 A
	500 V~	800 A	1000 A	1250 A	1600 A
	690 V~	800 A	1000 A	1250 A	1600 A
DC 23 A	250 V~	800 A	1000 A	1250 A	1600 A
I admissible Is (Icw)		12 kA efficient			
I admissible with fuse (Icc)		100 kA efficient			
Max. rating of fuse	gG	800 A	1000 A	1250 A	1600 A
	aM	800 A	1000 A	1250 A	1600 A
Short-circuit making capacity (kA peak) (Icm)		40 kA			
Endurance	mechanical	10000			
	electrical (AC 23 - 400 V~) (Icm)	3000	3000	2000	2000
Index of protection		IP 20 front panel			

### DPX-IS 630

Rating		400 A	630 A
Connection	Cu flexible	1 x 240 or 2 x 185 mm <sup>2</sup>	
	Cu rigid / Alu	1 x 300 or 2 x 240 mm <sup>2</sup>	
Copper bar		Width max. 32 mm	
Nominal rating (Ue)		690 V~	
Rated insulation voltage (Ui)		800 V~	
Rated impulse withstand voltage (Uimp)		8 kV~	
AC 23 A	400 V~	400 A	630 A
	500 V~	400 A	630 A
	690 V~	400 A	630 A
AC 22 A	690 V~	400 A	630 A
DC 23 A	250 V=	400 A	630 A
Rated closing capacity on short circuit (kA peak) (Icm)		40 kA	
I admissible Is (Icw)		20 kA efficient	
I admissible with fuse (kA efficient) (Icc)		100 kA	
Max. rating of fuse	gG	400 A	630 A
	aM	400 A	630 A
Endurance	mechanical	15000 operations	
	electrical (AC 23 - 400 V~)	1500 operations	
Index of protection		IP 20 front panel	



# DPX<sup>3</sup>-I trip-free switches

160 to 1600 A



4 202 99

Dimensions **see e-catalogue**

Trip-free switches for on-load circuit breaking and isolation of low voltage electrical circuits

Can be associated to earth leakage modules or to corresponding DPX<sup>3</sup> residual current relays

Mount on rail up to DPX<sup>3</sup> 250 with plate Cat.No 4 210 72 (DPX<sup>3</sup>-I 160) and Cat.No 4 210 71 (DPX<sup>3</sup> 250)

Conform to IEC 60947-3

Category of use AC 23 A

Connection identical to corresponding DPX<sup>3</sup>

## Pack Cat.Nos DPX<sup>3</sup>-I 160

Pack	Cat.Nos	In (A)
1	3P   4P 4 201 98   4 201 99	160
1	4P with earth leakage module 4 201 97	160

## DPX<sup>3</sup>-I 250

Pack	Cat.Nos	In (A)
1	3P   4P 4 202 99   4 203 00	250
1	4P with earth leakage module 4 202 98	250

## DPX<sup>3</sup>-I 630

Pack	Cat.Nos	In (A)
1	3P   4P 4 222 16   4 222 18	400
1	4 222 17   4 222 19	630

## DPX<sup>3</sup>-I 1600

Pack	Cat.Nos	In (A)
1	3P   4P 4 224 90   4 224 94	630
1	4 224 91   4 224 95	800
1	4 224 92   4 224 96	1250
1	4 224 93   4 224 97	1600

# DPX<sup>3</sup>-I trip-free switches

160 to 1600 A

## Electrical characteristics

	DPX <sup>3</sup> -I 160	DPX <sup>3</sup> -I 250	DPX <sup>3</sup> -I 630	DPX <sup>3</sup> -I 1600
Rated operating voltage U <sub>e</sub> (V)	50/60 Hz	690 <sup>(1)</sup>	690 <sup>(1)</sup>	690
	direct	250	250	250
Rated insulation voltage U <sub>i</sub> (V $\sim$ )		800	800	690
Rated impulse withstand voltage U <sub>imp</sub> (kV)		8	8	8
Rated closing capacity on 400 V short circuit I <sub>cm</sub> (kA)		3	3	6.5 <sup>(3)</sup> / 13 <sup>(4)</sup>
Short-time resistive current t = 1 s I <sub>cs</sub> (kA)		1.7	1.7	4 <sup>(5)</sup> / 7.6 <sup>(4)</sup>
Endurance (o.c. cycle)	mechanical	25000	25000	15000
	electrical	8000	8000	5000
Conventional thermal current (A)		160	250	630
Nominal current of use (A) AC 23 A (690 V $\sim$ )		160 (160 V)	250 (250 V)	630
DC 23 A (250 V $\sim$ )		160	160	630

1: 500 V for DPX<sup>3</sup>-I with earth leakage module

2: Up to 1250 A

3: I<sub>n</sub> = 400 A

4: I<sub>n</sub> = 630 A

5: I<sub>n</sub> = 800 A

6: I<sub>n</sub> = 1250 A

7: I<sub>n</sub> = 1600 A

## Dimensions

Dimensions of DPX<sup>3</sup>-I identical to corresponding DPX<sup>3</sup>

DPX <sup>3</sup> -I	Dimensions
DPX <sup>3</sup> -I 160	DPX <sup>3</sup> 160 (see e-catalogue)
DPX <sup>3</sup> -I 250	DPX <sup>3</sup> 250 (see e-catalogue)
DPX <sup>3</sup> -I 630	DPX <sup>3</sup> 630 (see e-catalogue)
DPX <sup>3</sup> -I 1600	DPX <sup>3</sup> 1600 (see e-catalogue)

## Choice of faceplates and distribution equipment

Equipment of DPX<sup>3</sup>-I identical to corresponding DPX<sup>3</sup>

Devices	XL <sup>3</sup> 400	XL <sup>3</sup> 800	XL <sup>3</sup> 4000
DPX <sup>3</sup> /DPX <sup>3</sup> -I 160	(p. 206)	(p. 217, 218)	(p. 227, 228)
DPX <sup>3</sup> /DPX <sup>3</sup> -I 250	(p. 206)	(p. 217, 218)	(p. 227, 228)
DPX <sup>3</sup> /DPX <sup>3</sup> -I 630	(p. 207)	(p. 218)	(p. 228)
DPX <sup>3</sup> /DPX <sup>3</sup> -I 1600		(p. 218)	(p. 228)

# DCX-M changeover switches

from 40 to 1600 A



4 311 21



4 311 24



4 311 26



4 311 29

Technical characteristics **see e-catalogue**

Conform to IEC EN 60947-3

Moulded case design with frame parts of non - flammable glass fibre reinforced polyester with high mechanical and electrical track resistance and with low water absorption

Knife - type contacts with self - wiping action on the contact surfaces, providing:

- under heavy starting currents or with short - circuit conditions, the contact pressure is increased

- shock and vibration proof contacts

Four breaking points per pole with two double - break contacts

Pack	Cat.Nos		Changeover switches		
			<b>Size 1</b>		
			Cage terminals		
	3P	3P+N	Intensity	Handle position	Connection
1	4 311 00	4 311 20	40 A	I - O - II	
1	4 311 01	4 311 21	63 A	I - O - II	
			<b>Size 2</b>		
			Connection with lugs		
1	4 311 02	4 311 22	100 A	I - O - II	
1	4 311 03	4 311 23	125 A	I - O - II	
1	4 311 04	4 311 24	160 A	I - O - II	
			<b>Size 3</b>		
			Connection with lugs		
1	4 311 05	4 311 25	200 A	I - O - II	
1	4 311 06	4 311 26	250 A	I - O - II	
1	4 311 07	4 311 27	315 A	I - O - II	
1	4 311 08	4 311 28	400 A	I - O - II	
			<b>Size 4</b>		
			Connection with lugs		
1	4 311 09	4 311 29	630 A	I - O - II	
1	4 311 10	4 311 30	800 A	I - O - II	

Pack	Cat.Nos		Changeover switches (continued)		
			<b>Size 5</b>		
			Connection with lugs		
	3P	3P+N	Intensity	Handle position	Connection
1	4 311 11	4 311 31	1000 A	I - O - II	
1	4 311 12	4 311 32	1250 A	I - O - II	
			<b>Size 6</b>		
			Connection with lugs		
1	4 311 13	4 311 33	1600 A	I - O - II	

# DCX-M changeover switches

## auxiliaries and accessories



4 311 40



4 311 42



4 311 55



4 311 60



4 311 61

Pack	Cat.Nos	Direct handles
20	4 311 45	Black rotary handles For DCX-M between 40 A and 160 A
20	4 311 46	For DCX-M between 200 A and 400 A
1	4 311 47	For DCX-M 630 A and 800 A
5	4 311 48	For DCX-M 1000 A and 1250 A
2	4 311 49	For DCX-M 1600 A

Pack	Cat.Nos	External handles
1	4 311 40	Black rotary handles Supplied with standard rod For DCX-M between 40 A and 160 A
20	4 311 41	For DCX-M between 200 A and 400 A
10	4 311 42	For DCX-M 630 A and 800 A
5	4 311 43	For DCX-M 1000 A and 1250 A
2	4 311 44	For DCX-M 1600 A

Pack	Cat.Nos	Extended shafts
1	4 311 50	Replace the standard rods supplied with the external handles, when required by the door distance For DCX-M between 40 A and 160 A
10	4 311 51	For DCX-M between 200 A and 400 A
10	4 311 52	For DCX-M 630 A and 800 A
10	4 311 53	For DCX-M 1000 A and 1250 A

Pack	Cat.Nos	Safety key lock devices
<b>Simple lock devices</b>		
2	4 311 70	For DCX-M between 40 A and 160 A
2	4 311 71	For DCX-M between 200 A and 400 A
2	4 311 72	For DCX-M 630 A and 800 A
2	4 311 73	For DCX-M 1000 A and 1250 A
2	4 311 74	For DCX-M 1600 A
<b>Double lock devices</b>		
2	4 311 75	For DCX-M between 40 A and 160 A
2	4 311 76	For DCX-M between 200 A and 400 A
2	4 311 77	For DCX-M 630 A and 800 A
2	4 311 78	For DCX-M 1000 A and 1250 A
2	4 311 79	For DCX-M 1600 A

Pack	Cat.Nos	Auxiliary contacts
<b>For DCX-M between 40 and 1250 A</b>		
10	4 311 55	1 NO + 1 NC
10	4 311 56	2 NO + 2 NC
<b>For DCX-M 1600 A</b>		
10	4 311 57	1 NO + 1 NC
10	4 311 58	2 NO + 2 NC

Pack	Cat.Nos	Bridging links
5	4 311 60	For DCX-M 40 A and 63 A
5	4 311 61	For DCX-M 100 A and 125 A
3	4 311 62	For DCX-M 1600 A

Pack	Cat.Nos	Rear protective plates
5	4 311 65	For DCX-M between 200 A and 400 A
5	4 311 66	For DCX-M 630 A and 800 A
5	4 311 67	For DCX-M 1000 A and 1250 A

Pack	Cat.Nos	Mounting kits for DCX-M
Kit comprising plate and faceplate for fixing DCX-M		
<b>For vertical mounting in XL<sup>3</sup> 800 and XL<sup>3</sup> 4000 enclosures</b>		
1	0 211 20	For DCX-M 40 A and 63 A
1	0 211 21	For DCX-M 100 A and 160 A
1	0 211 22	For DCX-M 200 A and 400 A
<b>For horizontal mounting in XL<sup>3</sup> 800 and XL<sup>3</sup> 4000 enclosures</b>		
1	0 211 27	For DCX-M 100 A and 160 A
1	0 211 28	For DCX-M 200 A and 400 A
<b>For vertical mounting in XL<sup>3</sup> 4000 enclosures</b>		
1	0 211 23	For DCX-M 630 A and 800 A
1	0 211 24	For DCX-M 1000 A and 1250 A
1	0 211 25	For DCX-M 1600 A
<b>For horizontal mounting in XL<sup>3</sup> 4000 enclosures</b>		
1	0 211 29	For DCX-M 630 A and 800 A

## DCX-M handles and accessories selection chart

								
A	Size	Connection	Changeover switch I-O-II		Direct handle	External handle		
			3P	4P		Cat.Nos	L (mm)	D (mm)
40	1	cage terminals	4 311 00	4 311 20	4 311 45	4 311 40	137	90 - 180
63	1	cage terminals	4 311 01	4 311 21	4 311 45	4 311 40	137	90 - 180
100	2	lugs	4 311 02	4 311 22	4 311 45	4 311 40	137	161 - 250
125	2	lugs	4 311 03	4 311 23	4 311 45	4 311 40	137	161 - 250
160	2	lugs	4 311 04	4 311 24	4 311 45	4 311 40	137	161 - 250
200	3	lugs	4 311 05	4 311 25	4 311 46	4 311 41	161	158 - 254
250	3	lugs	4 311 06	4 311 26	4 311 46	4 311 41	161	158 - 254
315	3	lugs	4 311 07	4 311 27	4 311 46	4 311 41	161	158 - 254
400	3	lugs	4 311 08	4 311 28	4 311 46	4 311 41	161	158 - 254
630	4	lugs	4 311 09	4 311 29	4 311 47	4 311 42	151	187 - 255
800	4	lugs	4 311 10	4 311 30	4 311 47	4 311 42	151	187 - 255
1000	5	lugs	4 311 11	4 311 31	4 311 48	4 311 43	125	215 - 264
1250	5	lugs	4 311 12	4 311 32	4 311 48	4 311 43	125	215 - 264
1600	6	lugs	4 311 13	4 311 33	4 311 49	4 311 44	204	413 - 573

Auxiliary contacts		Bridging links	Shaft extensions			Rear protective plate	Safety lock device	
1 NO + 1 NC	2 NO + 2 NC		Cat.Nos	L (mm)	D (mm)		Simple	Double
								
4 311 55	4 311 56	4 311 60	4 311 50	187	90 - 240	-	4 311 70	4 311 75
4 311 55	4 311 56	4 311 60	4 311 50	187	90 - 240	-	4 311 70	4 311 75
4 311 55	4 311 56	4 311 61	4 311 50	187	161 - 306	-	4 311 70	4 311 75
4 311 55	4 311 56	4 311 61	4 311 50	187	161 - 306	-	4 311 70	4 311 75
4 311 55	4 311 56	-	4 311 50	187	161 - 306	-	4 311 70	4 311 75
4 311 55	4 311 56	-	4 311 51	305	158 - 414	4 311 65	4 311 71	4 311 76
4 311 55	4 311 56	-	4 311 51	305	158 - 414	4 311 65	4 311 71	4 311 76
4 311 55	4 311 56	-	4 311 51	305	158 - 414	4 311 65	4 311 71	4 311 76
4 311 55	4 311 56	-	4 311 51	305	158 - 414	4 311 65	4 311 71	4 311 76
4 311 55	4 311 56	-	4 311 52	290	187 - 405	4 311 66	4 311 72	4 311 77
4 311 55	4 311 56	-	4 311 52	290	187 - 405	4 311 66	4 311 72	4 311 77
4 311 55	4 311 56	-	4 311 53	275	215 - 414	4 311 67	4 311 73	4 311 78
4 311 55	4 311 56	-	4 311 53	275	215 - 414	4 311 67	4 311 73	4 311 78
4 311 57	4 311 58	4 311 62	consult us	consult us	consult us	-	4 311 74	4 311 79



0 221 71



0 227 00



0 222 82

Technical characteristics **see e-catalogue**

Safety switch for disconnection and isolation of phases  
 IP 2X  
 Double breaking on each phase  
 Red rotary handle on yellow plate  
 Immediate display of position  
 - horizontal: open (O)  
 - vertical: closed (I)  
 Equipped with non reversible terminals  
 Conform to IEC EN 60947-3  
 UL-cUL (USA and Canada) agreements (except boxes)  
 IP 65 - IK 07 for boxes

Pack	Cat.Nos	Proximity switching
		Can be equipped with auxiliary contact Cat.No 0 227 00 Padlockable boxes for on-load breaking, isolation and locking in O position Equipment located remotely from a control cabinet Applications: breaking of CMV (controlled mechanical ventilation), motors, fixed or moving machines, air-conditioners
		<b>3P</b>
1	0 221 71	16 A
1	0 221 72	20 A
1	0 221 73	25 A
1	0 221 74	40 A
1	0 221 75	50 A
1	0 221 76	63 A
1	0 221 77	80 A
		<b>3P + N/O + N/C</b>
1	0 221 89	16 A
1	0 221 79	20 A
1	0 221 88	25 A

Pack	Cat.Nos	Proximity switching (continued)
		<b>4P - neutral on left-hand side</b>
1	0 221 81	16 A
1	0 221 82	20 A
1	0 221 83	25 A
1	0 221 84	40 A
1	0 221 85	50 A
1	0 221 86	63 A
1	0 221 87	80 A
		<b>Accessories</b>
		<b>Auxiliary contact</b>
1	0 227 00	N/O + N/C
		<b>Labels</b>
5	0 222 82	Marked "Main switch" Duty label for padlockable faceplate



## Proximity switching 32 to 160 A

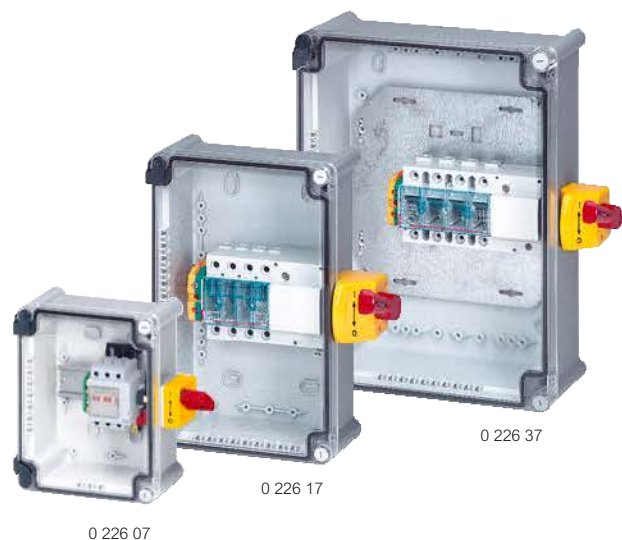

For on-load circuit breaking, isolation and locking in 0 position equipment located remotely

Applications:

- breaking of CMV (controlled mechanical ventilation) motors, fixed or moving machines, air-conditioners)

Can also be used as a:

- general switch
- emergency stop

IP 65

### Pack Cat.Nos Full load switch units 32 to 160 A

Pack	Cat.Nos	Full load switch units 32 to 160 A		
		Comprising:		
		- IP 65 plastic box with transparent hinged cover equipped with a Vistop with side red handle, yellow front plate with N/C + N/O auxiliary contact		
		- earth terminal (Viking 3)		
		<b>32 A - IK 07</b>		
		Supplied with 2 cable glands 21P - ISO 25		
		Connection	Earth terminal nominal capacity	
1	0 226 05	3P	16 mm <sup>2</sup> cage terminals	
1	0 226 07	4P	10 mm <sup>2</sup>	
		<b>63 A - IK 07</b>		
		Supplied with 2 cable glands 29P - ISO 32		
1	0 226 15	3P	cage terminals	
1	0 226 17	4P	50 mm <sup>2</sup> flexible	
			70 mm <sup>2</sup> rigid	
		<b>100 A - IK 07</b>		
		Supplied with 2 cable glands 36P - ISO 50		
1	0 226 25	3P	cage terminals	
1	0 226 27	4P	50 mm <sup>2</sup> flexible	
			70 mm <sup>2</sup> rigid	
		<b>125 A - IK 07</b>		
		Supplied with 2 cable glands 36P - ISO 50		
1	0 226 33	3P	cage terminals	
1	0 226 34	4P	50 mm <sup>2</sup> flexible	
			70 mm <sup>2</sup> rigid	
		<b>160 A - IK 07</b>		
		Supplied with 2 cable glands 36P - ISO 50		
1	0 226 35	3P	cage terminals	
1	0 226 37	4P	50 mm <sup>2</sup> flexible	
			70 mm <sup>2</sup> rigid	

## Proximity switching 32 to 160 A

### Full load switch units 32 to 160 A

#### Electrical characteristics

Identical to corresponding Vistop isolating switch

Switch units	Cat.Nos	Characteristics
32 A	0 226 05/07	Vistop 32 A p. 166
63 A	0 226 15/17	Vistop 63 A p. 166
100 A	0 226 25/27	Vistop 100 A p. 166
125 A	0 226 33/34	Vistop 125 A p. 166
160 A	0 226 35/37	Vistop 160 A p. 166

#### Dimensions

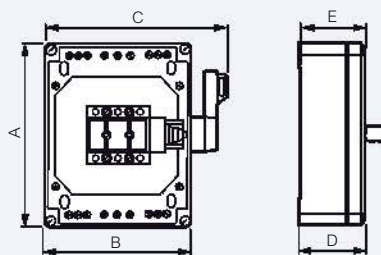

Cat.Nos	A	B	C	D	E
0 226 05/07 32 A	200	160	218	93	93
0 226 15/17 63 A	290	190	263	95	102
0 226 25/27/33/34 100/125 A	332	262	316	132	132
0 226 35/37 160 A	382	292	346	132	132

## SP fuse carriers

with protected terminals

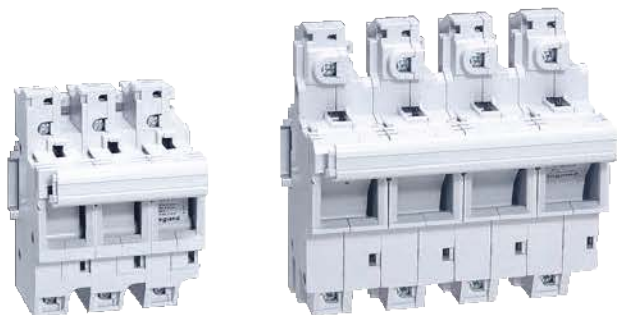

0 215 04

0 216 05

Conform to IEC 60269-2

Veritas approved

Height under front plate 44 mm

Mixed socket screw head for easier cable clamping

Screw or rail and mounting

Pack	Cat.Nos	SP 38 for HRC fuses 10 x 38		No of modules
3	0 214 04	Without microswitch	Connection	3
	0 214 05	3P	1 x 16 mm <sup>2</sup>	
2	0 214 05	3P + equipped neutral	or 2 x 10 mm <sup>2</sup>	4
<b>SP 51 for HRC fuses 14 x 51</b>				
1	0 215 04	Without microswitch	Connection	4.5
	0 215 05	3P	1 x 35 mm <sup>2</sup>	
1	0 215 05	3P + equipped neutral	or 2 x 16 mm <sup>2</sup>	6
<b>SP 58 for HRC fuses 22 x 58</b>				
1	0 216 04	Without microswitch	Connection	6
	0 216 05	3P	1 x 50 mm <sup>2</sup>	
1	0 216 05	3P + equipped neutral	or 2 x 25 mm <sup>2</sup>	8

## SP fuse carriers

with protected terminals

### Choice of equipment

Type	Rated current	Maximum cartridge rating					
		400 V~		500 V~		690 V~	
		gG	aM	gG	aM	gG	aM
SP 38	25 A	25	16	25	16	-	-
SP 51	50 A	50	50	50	40	25	25
SP 58	100 A (125 A in 400 V)	125	125	100	100	50	50

These values are standardized according to IEC 60269-2/2-1

They can be reduced or increased under certain specific applications

**Index of protection:** IP 2X - IP 2XC - under front plate

### Equipment derating

Recommended for equipment exposed to high temperatures:

- Ambient temperature over 35 °C: derate fuse by one rating per 10 °C (UTE C 20-051 / IEC 60943)
- Side-by-side equipment and simultaneous function

2 - 3 devices	0.9 x I <sub>n</sub>
4 - 5 devices	0.8 x I <sub>n</sub>
6 - 7 - 8 - 9 devices	0.7 x I <sub>n</sub>
≥ 10 devices	0.6 x I <sub>n</sub>

This coefficient is to be applied on the nominal rating of the base (IEC 60439-1)

- Uninterrupted usage: it may be necessary to upgrade the bases by one size

### Dimensions (mm)

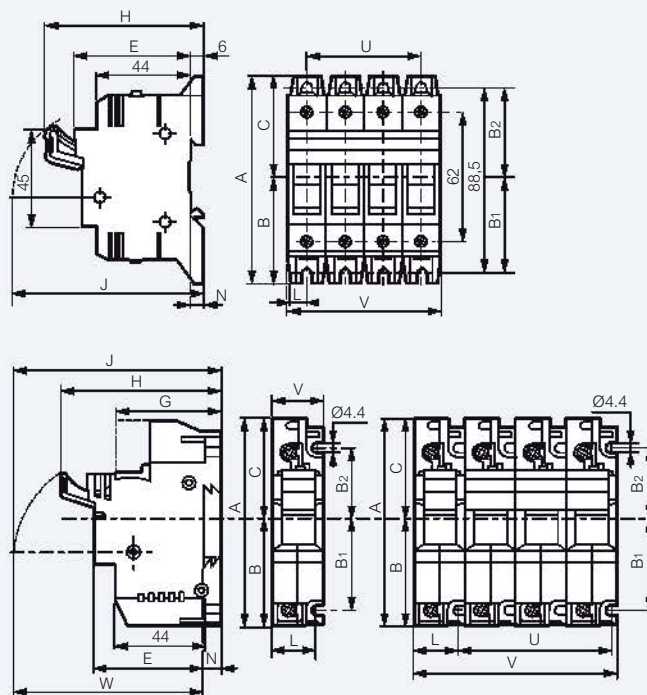

	A	B	B <sub>1</sub>	B <sub>2</sub>	C	E	G	H
SP 38	100	51	46	42.5	48.5	52	-	76
SP 51	106	54.5	45	35	51.5	55	53	84
SP 58	140	74	65	45	66	59	53	90

	J	L	N	U		V		W
				3P	3P+N	3P	3P+N	3P
SP 38	86	9	6	35.4	53.1	53.1	70.8	80
SP 51	99	20.7	9	53	79.5	79.5	106	90
SP 58	114	27	9	72	108	108	144	109



# HRC cartridge fuses



0 133 08      0 153 96      0 120 04      0 140 12      0 151 50

Technical data and dimensions [see e-catalogue](#)

Pack	Cat.Nos.		<b>Cylindrical type gG</b>				
	Conform to EN 60269-1, IEC 60269-1 and 2 Veritas approved						
	<b>8 x 32 (previously 8.5 x 31.5)</b>						
	Without indicator	With indicator	Rating (Amps)	Voltage ~ (Volts)	Rupture capacity (Amps)		
10	0 123 01		1	400	20000		
10	0 123 02	0 124 02	2				
10	0 123 04	0 124 04	4				
10	0 123 06	0 124 06	6				
10	0 123 10		10				
10		0 124 10	10				
10 100	0 123 16	0 124 16	16				
	Without indicator	With indicator	<b>10 x 38 HRC</b>				
10	0 133 94		0.5	500	100000		
10	0 133 01		1				
10	0 133 02	0 134 02	2				
10	0 133 04	0 134 04	4				
10	0 133 06	0 134 06	6				
10	0 133 08	0 134 08	8				
10	0 133 10	0 134 10	10				
10	0 133 16	0 134 16	16				
10	0 133 20	0 134 20	20				
10	0 133 25	0 134 25	25				
	Without striker	With striker	<b>14 x 51 HRC</b>				
10	0 143 06		6	500	100000		
10	0 143 10		10				
10	0 143 16	0 145 16	16				
10	0 143 20	0 145 20	20				
10	0 143 25	0 145 25	25				
10	0 143 32	0 145 32	32				
10	0 143 40	0 145 40	40				
10	0 143 50	0 145 50	50				
	Without striker	With striker	<b>22 x 58 HRC</b>				
10	0 153 16		16			500	100000
10	0 153 20		20				
10	0 153 25		25				
10	0 153 32		32				
10	0 153 40		40				
10	0 153 50	0 155 50	50				
10	0 153 63	0 155 63	63				
10	0 153 80	0 155 80	80				
10	0 153 96	0 155 96	100				
10	0 153 97 <sup>1</sup>	0 155 97 <sup>1</sup>	125	400			

Pack	Cat.Nos.		<b>Cylindrical type aM (motor rated)</b>			
	Conform to EN 60269-1, IEC 60269-1 and 2 Veritas approved					
	<b>8 x 32 (previously 8.5 x 31.5)</b>					
	Without indicator		Rating (Amps)	Voltage ~ (Volts)	Rupture capacity (Amps)	
10	0 120 04		4	400	20000	
10	0 120 06		6			
10	0 120 08		8			
10	0 120 10		10			
	Without indicator		<b>10 x 38 HRC</b>			
10	0 130 95		0.50	500	100000	
10	0 130 01		1			
10	0 130 02		2			
10	0 130 04		4			
10	0 130 06		6			
10	0 130 08		8			
10	0 130 10		10			
10	0 130 12		12			
10	0 130 16		16			
10	0 130 20		20			
10	0 130 25		25	400		
	Without striker	With striker	<b>14 x 51 HRC</b>			
10		0 141 02	2	500	100000	
10		0 141 04	4			
10		0 141 06	6			
10		0 141 08	8			
10	0 140 10	0 141 10	10			
10	0 140 12	0 141 12	12			
10	0 140 16	0 141 16	16			
10	0 140 20	0 141 20	20			
10	0 140 25	0 141 25	25			
10	0 140 32	0 141 32	32			
10	0 140 40	0 141 40	40			
10	0 140 50 <sup>1</sup>	0 141 50 <sup>1</sup>	50	400		
	Without striker	With striker	<b>22 x 58 HRC</b>			
10	0 150 25	0 151 25	25	500	100000	
10	0 150 32	0 151 32	32			
10	0 150 40	0 151 40	40			
10	0 150 50	0 151 50	50			
10	0 150 63	0 151 63	63			
10	0 150 80	0 151 80	80			
10	0 150 96	0 151 96	100			
10	0 150 97 <sup>1</sup>	0 151 97 <sup>1</sup>	125			400

<b>Neutral links</b>		
10	0 123 00	8 x 32 (previously 8.5 x 31.5)
10	0 133 00	10 x 38
10	0 143 00	14 x 51
10	0 153 00	22 x 58

1: Overrating not described by standards

For technical data and dimensions, [see e-catalogue](#)



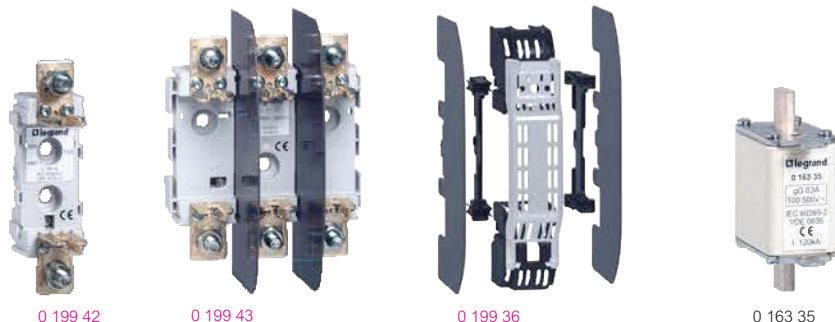

Conform to IEC 60269-2

Pack	Cat.Nos	Bases for blade type cartridge fuses			
		Self-extinguishing plastic bases Contact points are sprung			
		<b>Bare</b>			
		Size	In (A)	Mounting	Connection
3	1P	000/00	100	screw or	M8
3	3P	000/00	160	rail	M8
3	1P	0	160	screw or	M8
3	1P	1	250	rail	M10
3	1P	2	400	rail	M10
		<b>With micro-switch</b>			
		Equipped with "present cartridge" and "blown fuse" indicator for cartridge fuses with striker			
3	1P	0	160	screw or	M8
1	1P	1	250	rail	M10
1	1P	2	400	rail	M10
		<b>Handle</b>			
5	0 199 02	For all sizes			
		<b>Accessories</b>			
		<b>Separation dividers and joining accessories kits</b>			
		Base Size	Number of dividers	Number of joining accessories	For base Cat.No
5	0 199 30 <sup>2</sup>	000/00	2	0	0 199 42/44
5	0 199 31	0	2	2	0 199 46/47
5	0 199 32	1/2	2	2	0 199 48/49 /50/51
		<b>Protection kits</b>			
		For protection against accidental contacts, Kits consisting of : separation dividers, joining accessories, terminal shields and fuse covers			
5	1P	0 199 35 <sup>2</sup> For bases size 00 Cat.No 0 199 42/44			
5	1P	0 199 36 For bases size 0 Cat.No 0 199 46			
5	1P	0 199 37 For bases size 1 Cat.No 0 199 48			
5	1P	0 199 38 For bases size 2 Cat.No 0 199 50			
5	3P	0 199 39 <sup>2</sup> For bases size 00 Cat.No 0 199 43/45			
		1: Supplied with 2 separation dividers 2: Supplied without joining accessories (separation dividers are fixed directly on the base of)			

Pack	Cat.Nos	Type gG / gL		
		Conform to IEC 60269-2 For protection against accidental contacts, use terminal shields and fuse covers supplied with protection kits		
		<b>Size 00</b>		
		Rating (Amps)	Voltage ~ (Volts)	Breaking capacity (Amps)
10	0 163 18	25	500	120000
10	0 163 20	32		
10	0 163 22	35		
10	0 163 25	40		
10	0 163 30	50		
10	0 163 35	63		
10	0 163 40	80		
10	0 163 45	100		
10	0 163 50	125		
10	0 163 55	160		
		<b>Size 0</b>		
3	0 168 35	63	500	120000
3	0 168 40	80		
3	0 168 45	100		
3	0 168 50	125		
3	0 168 55	160		
		<b>Size 1</b>		
3	0 173 50	125	500	120000
3	0 173 55	160		
3	0 173 60	200		
3	0 173 65	250		
		<b>Size 2</b>		
3	0 178 60	200	500	120000
3	0 178 65	250		
3	0 178 70	315		
3	0 178 75	400		
		<b>Type aM (motor rated)</b>		
		Conform to EN 60269-1 IEC 60269-1, 2 and VDE 0636-1 Fully insulated end plate and handle lugs		
		<b>Size 00</b>		
		Rating (Amps)	Voltage ~ (Volts)	Breaking capacity (Amps)
3	0 160 35	63	500	120000
3	0 160 40	80		
3	0 160 45	100		
3	0 160 50	125		
		<b>Size 0</b>		
3	0 166 35	63	500	120000
3	0 166 40	80		
3	0 166 45	100		
3	0 166 50	125		
3	0 166 55	160		
		<b>Size 1</b>		
3	0 171 50	125	500	120000
3	0 171 55	160		
3	0 171 60	200		
3	0 171 65	250		
		<b>Size 2</b>		
3	0 176 60	200	500	120000
3	0 176 65	250		
3	0 176 70	315		
3	0 176 75	400		

For technical data and dimensions, see e-catalogue





# MPX<sup>3</sup>, CTX<sup>3</sup>, RTX<sup>3</sup>

a complete range of devices  
for protection and control  
of motors



## MPX<sup>3</sup> MPCBs

- Compact design
- Rated current up to 100 A
- High breaking capacity range : 100 kA at 230 V for all rated currents
- Complete range of common control and signalling auxiliaries and accessories

## CTX<sup>3</sup> CONTACTORS

- Compact design
- 3-pole and 4-pole
- Operating current from 9 to 800 A
- Screw and lug terminals
- Complete range of auxiliaries and accessories

STANDARD BREAKING CAPACITY	HIGH BREAKING CAPACITY	MAGNETIC ONLY
----------------------------	------------------------	---------------



MPX<sup>3</sup> 32S



MPX<sup>3</sup> 32H



MPX<sup>3</sup> 63H



MPX<sup>3</sup> 100 H



MPX<sup>3</sup> 32MA





- RTX<sup>3</sup> thermal overload relays
- Differential and non-differential versions
  - Direct connection on CTX<sup>3</sup> contactors
  - Mounting units available for mounting separately from contactors



4-pole CTX<sup>3</sup> contactors from 40 to 800 A

# MPCBs MPX<sup>3</sup>

## technical characteristics

																							
<b>MPCB</b>		<b>MPX<sup>3</sup> 32S</b>										<b>MPX<sup>3</sup> 32H</b>											
	<b>Size</b>	1										2											
	<b>Type</b>	Thermal magnetic										Thermal magnetic											
	<b>Breaking capacity</b>	Standard										High											
	<b>Handle type</b>	Toggle										Rotary											
	<b>Number of poles</b>	3										3											
<b>Characteristics of use</b>																							
	<b>Rated operational voltage (Ue)</b>	Up to 690 V										Up to 690 V											
	<b>Rated frequency</b>	50/60 Hz										50/60 Hz											
	<b>Rated insulation voltage (Ui)</b>	690 V										690 V											
	<b>Rated impulse voltage (Uimp)</b>	6 kV										6 kV											
<b>Utilisation category</b>	<b>IEC 60947-2 (breaker)</b>	Cat. A										Cat. A											
	<b>IEC 60947-4 (Motor starter)</b>	AC3										AC3											
	<b>Mechanical endurance (Operating)</b>	100000										100000											
	<b>Electric endurance (Cycles)</b>	100000										100000											
	<b>Max operating frequency per hour (Ope./h)</b>	25										25											
	<b>Temperature compensation</b>	-20 to +60°C										-20 to +60°C											
	<b>Instantaneous short circuit release</b>	13 x I <sub>e</sub> max.										13 x I <sub>e</sub> max.											
	<b>Trip class</b>	10										10											
	<b>Overload protection</b>	•										•											
	<b>Phase failure protection</b>	•										•											
	<b>Trip indicating function</b>	with alarm contact 4 174 06/07										with alarm contact 4 174 06/07											
	<b>Test function</b>	•										•											
	<b>Weight (g)</b>	320										360											
<b>Rated breaking capacity (kA)</b>	<b>Rated operational current I<sub>e</sub> (A)</b>	<b>Thermal release adjustment range (A)</b>	<b>240V 230V 220V</b>		<b>415V 400V</b>		<b>460V 440V</b>		<b>525V 500V</b>		<b>690V 600V</b>		<b>240V 230V 220V</b>		<b>415V 400V</b>		<b>460V 440V</b>		<b>525V 500V</b>		<b>690V 600V</b>		
			<b>I<sub>cu</sub></b>	<b>I<sub>cs</sub></b>	<b>I<sub>cu</sub></b>	<b>I<sub>cs</sub></b>	<b>I<sub>cu</sub></b>	<b>I<sub>cs</sub></b>	<b>I<sub>cu</sub></b>	<b>I<sub>cs</sub></b>	<b>I<sub>cu</sub></b>	<b>I<sub>cs</sub></b>	<b>I<sub>cu</sub></b>	<b>I<sub>cs</sub></b>	<b>I<sub>cu</sub></b>	<b>I<sub>cs</sub></b>	<b>I<sub>cu</sub></b>	<b>I<sub>cs</sub></b>	<b>I<sub>cu</sub></b>	<b>I<sub>cs</sub></b>	<b>I<sub>cu</sub></b>	<b>I<sub>cs</sub></b>	<b>I<sub>cu</sub></b>
	0.16	0.1 to 0.16	100	100	100	100	100	100	100	100	100	100	100	100	100	100	100	100	100	100	100	100	100
	0.25	0.16 to 0.25	100	100	100	100	100	100	100	100	100	100	100	100	100	100	100	100	100	100	100	100	100
	0.4	0.25 to 0.4	100	100	100	100	100	100	100	100	100	100	100	100	100	100	100	100	100	100	100	100	100
	0.63	0.4 to 0.63	100	100	100	100	100	100	100	100	100	100	100	100	100	100	100	100	100	100	100	100	100
	1	0.63 to 1	100	100	100	100	100	100	100	100	100	100	100	100	100	100	100	100	100	100	100	100	100
	1.6	1 to 1.6	100	100	100	100	100	100	100	100	3	3	100	100	100	100	100	100	100	100	100	100	100
	2.5	1.6 to 2.5	100	100	100	100	100	100	50	38	3	3	100	100	100	100	100	100	100	100	8	8	
	4	2.5 to 4	100	100	100	100	50	38	15	11	3	3	100	100	100	100	100	100	100	100	8	8	
	6	4 to 6	100	100	100	100	15	11	10	8	3	3	100	100	100	100	100	100	100	100	6	6	
	8	5 to 8	100	100	100	100	15	11	10	8	3	3	100	100	100	100	50	38	50	38	6	6	
	10	6 to 10	100	100	50	38	15	11	6	5	3	3	100	100	100	100	50	38	50	38	6	6	
	13	9 to 13	100	100	50	38	10	8	6	5	3	3	100	100	100	100	50	38	42	32	6	6	
	17	11 to 17	50	38	20	15	10	8	6	5	3	3	100	100	50	38	20	15	10	8	4	4	
	22	14 to 22	40	30	15	11	8	6	6	5	3	3	100	100	50	38	20	15	10	8	4	4	
	26	18 to 26	40	30	15	11	8	6	5	4	3	3	100	100	50	38	20	15	10	8	4	4	
	32	22 to 32	30	22	15	11	6	4	5	4	3	3	100	100	50	38	20	15	10	8	4	4	
	40	28 to 40	-	-	-	-	-	-	-	-	-	-	-	-	-	-	-	-	-	-	-	-	
	50	34 to 50	-	-	-	-	-	-	-	-	-	-	-	-	-	-	-	-	-	-	-	-	
	63	45 to 63	-	-	-	-	-	-	-	-	-	-	-	-	-	-	-	-	-	-	-	-	
	75	55 to 75	-	-	-	-	-	-	-	-	-	-	-	-	-	-	-	-	-	-	-	-	
	90	70 to 90	-	-	-	-	-	-	-	-	-	-	-	-	-	-	-	-	-	-	-	-	
	100	80 to 100	-	-	-	-	-	-	-	-	-	-	-	-	-	-	-	-	-	-	-	-	



**MPX³ 32MA**

2  
Magnetic only  
High  
Rotary  
3



**MPX³ 63H**

3  
Thermal magnetic  
High  
Rotary  
3



**MPX³ 100H**

4  
Thermal magnetic  
High  
Rotary  
3

Up to 690 V

50/60 Hz

690 V

6 kV

Cat. A

AC3

100000

100000

25

-20 to +60°C

13 x I<sub>e</sub> max.

0

-

-

with alarm contact 4 174 06/07

•

360

Up to 690 V

50/60 Hz

1000 V

8 kV

Cat. A

AC3

50000

25000

25

-20 to +60°C

13 x I<sub>e</sub> max.

10

•

•

with alarm contact 4 174 06/07

•

1000

Up to 690 V

50/60 Hz

1000 V

8 kV

Cat. A

AC3

50000

25000

25

-20 to +60°C

13 x I<sub>e</sub> max.

10

•

•

with alarm contact 4 174 06/07

•

2200

240V 230V 220V		415V 400V		460V 440V		525V 500V		690V 600V		240V 230V 220V		415V 400V		460V 440V		525V 500V		690V 600V		240V 230V 220V		415V 400V		460V 440V		525V 500V		690V 600V	
I <sub>cu</sub>	I <sub>cs</sub>	I <sub>cu</sub>	I <sub>cs</sub>	I <sub>cu</sub>	I <sub>cs</sub>	I <sub>cu</sub>	I <sub>cs</sub>	I <sub>cu</sub>	I <sub>cs</sub>	I <sub>cu</sub>	I <sub>cs</sub>	I <sub>cu</sub>	I <sub>cs</sub>	I <sub>cu</sub>	I <sub>cs</sub>	I <sub>cu</sub>	I <sub>cs</sub>	I <sub>cu</sub>	I <sub>cs</sub>	I <sub>cu</sub>	I <sub>cs</sub>	I <sub>cu</sub>	I <sub>cs</sub>	I <sub>cu</sub>	I <sub>cs</sub>	I <sub>cu</sub>	I <sub>cs</sub>	I <sub>cu</sub>	I <sub>cs</sub>
100	100	100	100	100	100	100	100	100	100	-	-	-	-	-	-	-	-	-	-	-	-	-	-	-	-	-	-	-	-
100	100	100	100	100	100	100	100	100	100	-	-	-	-	-	-	-	-	-	-	-	-	-	-	-	-	-	-	-	-
100	100	100	100	100	100	100	100	100	100	-	-	-	-	-	-	-	-	-	-	-	-	-	-	-	-	-	-	-	-
100	100	100	100	100	100	100	100	100	100	-	-	-	-	-	-	-	-	-	-	-	-	-	-	-	-	-	-	-	-
100	100	100	100	100	100	100	100	100	100	-	-	-	-	-	-	-	-	-	-	-	-	-	-	-	-	-	-	-	-
100	100	100	100	100	100	100	100	100	100	-	-	-	-	-	-	-	-	-	-	-	-	-	-	-	-	-	-	-	-
100	100	100	100	100	100	100	100	100	8	8	-	-	-	-	-	-	-	-	-	-	-	-	-	-	-	-	-	-	-
100	100	100	100	100	100	100	100	100	8	8	-	-	-	-	-	-	-	-	-	-	-	-	-	-	-	-	-	-	-
100	100	100	100	100	100	100	100	6	6	-	-	-	-	-	-	-	-	-	-	-	-	-	-	-	-	-	-	-	-
100	100	100	100	50	38	50	38	6	6	-	-	-	-	-	-	-	-	-	-	-	-	-	-	-	-	-	-	-	-
100	100	100	100	50	38	50	38	6	6	100	100	100	100	50	38	50	38	6	5	-	-	-	-	-	-	-	-	-	-
100	100	100	100	50	38	42	32	6	6	100	100	100	100	50	38	42	32	6	5	-	-	-	-	-	-	-	-	-	-
100	100	50	38	20	15	10	8	4	4	100	100	50	50	50	38	12	9	5	5	100	100	100	100	50	38	35	27	12	9
100	100	50	38	20	15	10	8	4	4	100	100	50	50	50	38	12	9	5	5	100	100	100	100	50	38	35	27	12	9
100	100	50	38	20	15	10	8	4	4	100	100	50	50	35	27	12	9	5	5	100	100	100	100	50	38	35	27	12	9
100	100	50	38	20	15	10	8	4	4	100	100	50	50	35	27	10	8	5	5	100	100	100	100	50	38	25	19	12	9
-	-	-	-	-	-	-	-	-	-	100	100	50	50	35	27	10	8	5	5	100	100	100	100	50	38	20	15	12	9
-	-	-	-	-	-	-	-	-	-	100	100	50	50	35	27	10	8	5	5	100	100	100	100	50	38	15	11	10	8
-	-	-	-	-	-	-	-	-	-	100	100	50	50	35	27	10	8	5	5	100	100	100	100	50	38	15	11	8	6
-	-	-	-	-	-	-	-	-	-	-	-	-	-	-	-	-	-	-	-	100	100	75	50	50	38	12	9	6	6
-	-	-	-	-	-	-	-	-	-	-	-	-	-	-	-	-	-	-	-	100	100	75	50	50	38	12	9	6	6
-	-	-	-	-	-	-	-	-	-	-	-	-	-	-	-	-	-	-	-	100	100	75	50	50	38	12	9	6	6

# MPCBs MPX<sup>3</sup>

motor protection circuit breakers from 0.16 A to 100 A

**N** AVAILABLE  
SEPT 2014



4 173 08

4 173 68

4 173 79

4 173 48

Technical characteristics **p. 166**  
Dimensions and wiring capacity chart **see e-catalogue**

Conform to IEC 60947-1, IEC 60947-2, IEC 60947-4

Pack	Cat. Nos	Thermal magnetic MPCBs			
		Adjustable thermal release Magnetic release 13 le max.			
		<b>MPX<sup>3</sup> 32S</b>			
		Standard breaking capacity With toggle handle Fixing on rail			
		Rated operational current I <sub>e</sub> (A)	Thermal release adjustment range (A)	Magnetic release operating current (A)	415 V breaking capacity I <sub>cu</sub> (kA)
	3P				
1	4 173 00	0.16	0.1 to 0.16	2.1	100
1	4 173 01	0.25	0.16 to 0.25	3.3	100
1	4 173 02	0.4	0.25 to 0.4	5.2	100
1	4 173 03	0.63	0.4 to 0.63	8.2	100
1	4 173 04	1	0.63 to 1	13	100
1	4 173 05	1.6	1 to 1.6	20.8	100
1	4 173 06	2.5	1.6 to 2.5	32.5	100
1	4 173 07	4	2.5 to 4	52	100
1	4 173 08	6	4 to 6	78	100
1	4 173 09	8	5 to 8	104	100
1	4 173 10	10	6 to 10	130	50
1	4 173 11	13	9 to 13	169	50
1	4 173 12	17	11 to 17	221	20
1	4 173 13	22	14 to 22	286	15
1	4 173 14	26	18 to 26	338	15
1	4 173 15	32	22 to 32	416	15
		<b>MPX<sup>3</sup> 32H</b>			
		High breaking capacity With rotary handle Fixing on rail			
1	4 173 20	0.16	0.1 to 0.16	2.1	100
1	4 173 21	0.25	0.16 to 0.25	3.3	100
1	4 173 22	0.4	0.25 to 0.4	5.2	100
1	4 173 23	0.63	0.4 to 0.63	8.2	100
1	4 173 24	1	0.63 to 1	13	100
1	4 173 25	1.6	1 to 1.6	20.8	100
1	4 173 26	2.5	1.6 to 2.5	32.5	100
1	4 173 27	4	2.5 to 4	52	100
1	4 173 28	6	4 to 6	78	100
1	4 173 29	8	5 to 8	104	100
1	4 173 30	10	6 to 10	130	100
1	4 173 31	13	9 to 13	169	100
1	4 173 32	17	11 to 17	221	50
1	4 173 33	22	14 to 22	286	50
1	4 173 34	26	18 to 26	338	50
1	4 173 35	32	22 to 32	416	50
		<b>MPX<sup>3</sup> 63H</b>			
		High breaking capacity With rotary handle Fixing on rail  or by screw			
1	4 173 60	10	6 to 10	130	100
1	4 173 61	13	9 to 13	169	100
1	4 173 62	17	11 to 17	221	50
1	4 173 63	22	14 to 22	286	50
1	4 173 64	26	18 to 26	338	50
1	4 173 65	32	22 to 32	416	50
1	4 173 66	40	28 to 40	520	50
1	4 173 67	50	34 to 50	650	50
1	4 173 68	63	45 to 63	819	50

Pack	Cat. Nos	Thermal magnetic MPCBs (continued)			
		<b>MPX<sup>3</sup> 100H</b>			
		High breaking capacity With rotary handle Fixing on rail  or by screw			
		Rated operational current I <sub>e</sub> (A)	Thermal release adjustment range (A)	Magnetic release operating current (A)	415 V breaking capacity I <sub>cu</sub> (kA)
	3P				
1	4 173 70	17	11 to 17	221	100
1	4 173 71	22	14 to 22	286	100
1	4 173 72	26	18 to 26	338	100
1	4 173 73	32	22 to 32	416	100
1	4 173 74	40	28 to 40	520	100
1	4 173 75	50	34 to 50	650	100
1	4 173 76	63	45 to 63	819	100
1	4 173 77	75	55 to 75	975	75
1	4 173 78	90	70 to 90	1170	75
1	4 173 79	100	80 to 100	1300	75
		<b>Magnetic only MPCBs</b>			
		Without thermal release Magnetic release 13 x I <sub>e</sub> max.			
		<b>MPX<sup>3</sup> 32MA</b>			
		High breaking capacity With rotary handle Fixing on rail			
		Rated operational current I <sub>e</sub> (A)	Magnetic release operating current (A)	415 V breaking capacity I <sub>cu</sub> (kA)	
	3P				
1	4 173 40	0.16	2.1	100	
1	4 173 41	0.25	3.3	100	
1	4 173 42	0.4	5.2	100	
1	4 173 43	0.63	8.2	100	
1	4 173 44	1	13	100	
1	4 173 45	1.6	20.8	100	
1	4 173 46	2.5	32.5	100	
1	4 173 47	4	52	100	
1	4 173 48	6	78	100	
1	4 173 49	8	104	100	
1	4 173 50	10	130	100	
1	4 173 51	13	169	100	
1	4 173 52	17	221	50	
1	4 173 53	22	286	50	
1	4 173 54	26	338	50	
1	4 173 55	32	416	50	

For dimensions and wiring capacity  
**see e-catalogue**



# MPCBs MPX<sup>3</sup>

accessories

**N** AVAILABLE SEPT 2014

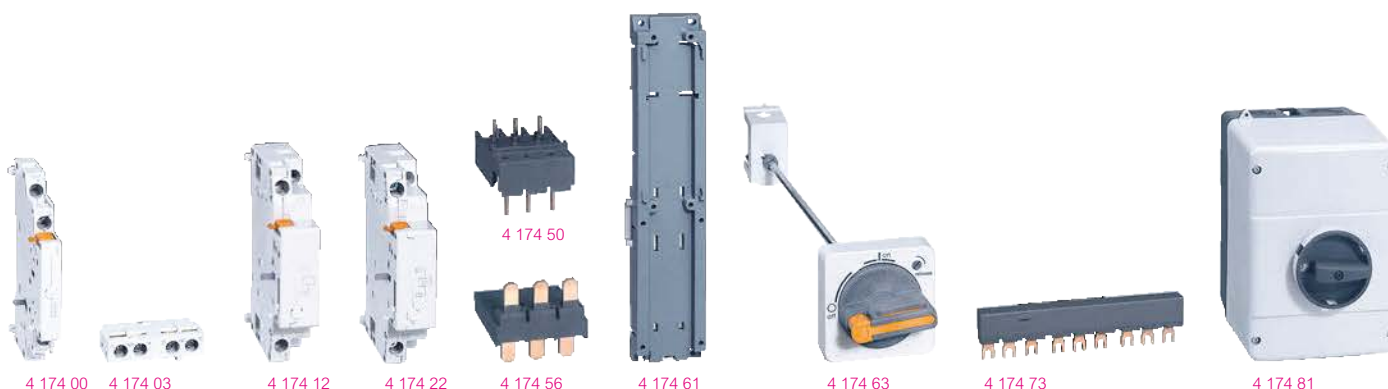

Pack	Cat. Nos	Accessories	Pack	Cat. Nos	Accessories
		<b>Auxiliary contacts</b>			<b>Direct adaptator and mounting unit</b>
		2-pole			For mounting CTX <sup>3</sup> contactors under MPX <sup>3</sup> MPCBs
		<b>Side mounting</b>			<b>Direct adaptators</b>
		Mounting on the left side of MPCBs			Used to connect MPX <sup>3</sup> directly with the contactor
1	4 174 00	One module per MPCB	1	4 174 48	For MPX <sup>3</sup> 32S with CTX <sup>3</sup> 22 AC (p. 170)
1	4 174 01	1 NO + 1 NC	1	4 174 49	For MPX <sup>3</sup> 32S with CTX <sup>3</sup> 22 DC (p. 170)
1	4 174 02	2 NO	1	4 174 50	For MPX <sup>3</sup> 32H/32MA with CTX <sup>3</sup> 22 AC (p. 170)
		2 NC	1	4 174 51	For MPX <sup>3</sup> 32H/32MA with CTX <sup>3</sup> 22 DC (p. 170)
		<b>Front mounting</b>	1	4 174 52	For MPX <sup>3</sup> 32S with CTX <sup>3</sup> 40 AC (p. 170)
		One module per MPCB	1	4 174 53	For MPX <sup>3</sup> 32S with CTX <sup>3</sup> 40 DC (p. 170)
1	4 174 03	1 NO + 1 NC	1	4 174 54	For MPX <sup>3</sup> 32H/32MA with CTX <sup>3</sup> 40 AC (p. 170)
1	4 174 04	2 NO	1	4 174 55	For MPX <sup>3</sup> 32H/32MA with CTX <sup>3</sup> 40 DC (p. 170)
1	4 174 05	2 NC	1	4 174 56	For MPX <sup>3</sup> 63H with CTX <sup>3</sup> 65 AC with lug type terminals (p. 170)
		<b>Alarm contacts</b>	1	4 174 57	For MPX <sup>3</sup> 63H with CTX <sup>3</sup> 65 DC with lug type terminals (p. 170)
		2-pole	1	4 174 58	For MPX <sup>3</sup> 100H with CTX <sup>3</sup> 100 AC with lug type terminals (p. 170)
		<b>Any trip alarm contact</b>	1	4 174 59	For MPX <sup>3</sup> 100H with CTX <sup>3</sup> 100 DC with lug type terminals (p. 170)
		Operate in case of trip			<b>Mounting unit</b>
		Mounting on the left side of MPCBs			This device is used for joining together MPX <sup>3</sup> MCPBs and CTX <sup>3</sup> contactors
		Set alarm contact first in case of using auxiliary contact together (MPX <sup>3</sup> 63H can not accept auxiliary contact and alarm contact together)			Screws not supplied
1	4 174 06	1 NO + 1 NC	1	4 174 60	For MPX <sup>3</sup> 32S/32H/32MA
		<b>Magnetic trip alarm contact</b>	1	4 174 61	For MPX <sup>3</sup> 63H
		Operate in case of instantaneous trip	1	4 174 62	For MPX <sup>3</sup> 100H
		Mounting on the left side of MPCBs			<b>Rotary handle</b>
		Set alarm contact first in case of using auxiliary contact together			Mounting on panel's door to control the MPX <sup>3</sup>
1	4 174 07	1 NO + 1 NC	1	4 174 63	For MPX <sup>3</sup> 32H and 32 MA
		<b>Shunt release</b>	1	4 174 64	For MPX <sup>3</sup> 63H
		Mounting on the right side of MPCBs	1	4 174 65	For MPX <sup>3</sup> 100H
		One release per MPCB			<b>Phase busbar</b>
1	4 174 10	24 V - 50 Hz / 28 V - 60 Hz			For parallel connection of MPX <sup>3</sup>
1	4 174 11	110 V - 50 Hz / 120 V - 60 Hz			<b>For MPX<sup>3</sup> 32S, 32H and 32MA</b>
1	4 174 12	220-230 V - 50 Hz / 240-260 V - 60 Hz			Rated current 63 A
1	4 174 13	380-400 V - 50 Hz / 440-460 V - 60 Hz	1	4 174 71	2 devices
		<b>Undervoltage release</b>	1	4 174 73	3 devices
		Mounting on the right side of MPCBs	1	4 174 75	4 devices
		One release per MPCB	1	4 174 76	5 devices
		<b>Without auxiliary contact</b>	1	4 174 77	Feeder for phase busbar
1	4 174 20	24 V - 50 Hz / 28 V - 60 Hz			<b>For MPX<sup>3</sup> 63H</b>
1	4 174 21	110 V - 50 Hz / 120 V - 60 Hz			Rated current 108 A
1	4 174 22	220-230 V - 50 Hz / 240-260 V - 60 Hz	1	4 174 72	2 devices
1	4 174 23	380-400 V - 50 Hz / 440-460 V - 60 Hz	1	4 174 74	3 devices
		<b>With 2 NO auxiliary contacts</b>			<b>Enclosures for MPX<sup>3</sup> 32H and 32MA</b>
		Can not attach to MPX <sup>3</sup> 32S			IP 65 enclosure to use in dusty areas as well as in presence of corrosive gas or liquid
1	4 174 30	24 V - 50 Hz / 28 V - 60 Hz	1	4 174 80	With yellow/red rotary handle
1	4 174 31	110 V - 50 Hz / 120 V - 60 Hz	1	4 174 81	With black rotary handle
1	4 174 32	220-230 V - 50 Hz / 240-260 V - 60 Hz			
1	4 174 33	380-400 V - 50 Hz / 440-460 V - 60 Hz			
		<b>Dial Cover</b>			
		Sealable cover to protect the set value from the operation that is not intended			
1	4 174 79	For all types of MPX <sup>3</sup>			

# MPCBs MPX<sup>3</sup>

## technical characteristics

### Mounting

MPX<sup>3</sup> 32: 35 mm rail (depth 15 mm)  
 MPX<sup>3</sup> 63: 35 mm rail (depth 15 mm) or screws  
 MPX<sup>3</sup> 100: 35 mm (depth 15 mm) or 75 mm rail or screws

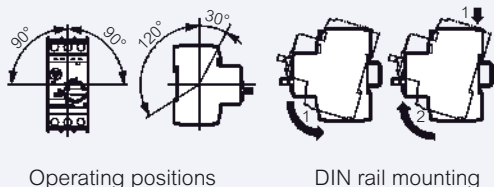

### Caution for thermal adjustments

1. Keep the setting range as shown below
2. Moving counterclockwise out of the setting range may cause the damage of the device

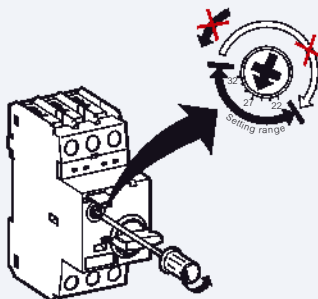

Dial setting method

3. Calibration by ambient air temperature



### Environment

Ambient air temperature:  
 - storage: -50...+80°C  
 - operation: -20...+60°C  
 Ambient temperature compensation: -20...+60°C  
 Maximum operating altitude: 2000 m  
 Protection degree: IP20  
 Shock resistance: 25 g  
 Vibration resistance: 5~150 Hz

### Power consumption

	MPX <sup>3</sup> 32S	MPX <sup>3</sup> 32H/MA	MPX <sup>3</sup> 63H	MPX <sup>3</sup> 100H
<b>Total power loss Pv</b>	In = 0.16 to 1.6 A: 4.4	In = 0.16 to 1.6 A: 4.4	In = 10 to 22 A: 10.2	In = 17 to 32 A : 15
<b>Circuit breaker at rated load operating temperature (W)</b>	In = 2.5 to 26 A : 7.4 In = 32 A : 4.0	In = 2.5 to 26 A : 7.4 In = 32 A : 4.0	In = 26 to 63 A: 9.7	In = 40 to 63 A : 21.8 In = 75 to 100 A: 17.8

### MPX<sup>3</sup> 32S

Rated operational current I <sub>e</sub> (A)	0.16	0.25	0.4	0.63	1	1.6	2.5	4	6	8	10	13	17	22	26	32
<b>Switching of standard three-phase motors AC-2, AC-3</b>																
230/240V (kW)	-	0.03	0.06	0.09	0.12	0.18/0.25	0.37	0.55/0.75	1.1/1.5	1.5	2.2/3	3	3.7/4	4	5.5	7.5
400/415V (kW)	0.02	0.06	0.09	0.12	0.18/0.25	0.37/0.55	0.75	1.1/1.5	2.2	3	3.7/4	5.5	7.5	7.5	11	15
500V (kW)	-	-	-	0.25	0.37	0.55/0.75	1.1	1.5/2.2	3	3.7	4/5.5	7.5	11	11	15	18.5
690V (kW)	-	-	-	0.25	0.37/0.55	0.75/1.1	1.5	2.2/3	3.7/4	5.5	7.5	11	11	15	18.5	22
<b>Back-up fuses gG, gL, only if I<sub>cc</sub> &gt; I<sub>cu</sub> (* = no back up fuse required)</b>																
230/240V (A)	*	*	*	*	*	*	*	*	*	*	*	*	*	125	125	125
400/415V (A)	*	*	*	*	*	*	*	*	*	*	*	80	100	100	100	100
440/460V (A)	*	*	*	*	*	*	*	50	50	63	63	80	80	100	100	100
500V (A)	*	*	*	*	*	*	50	40	50	63	63	80	80	80	80	80
690V (A)	*	*	*	*	*	20	35	40	50	63	63	63	63	63	63	63

### MPX<sup>3</sup> 32H

Rated operational current I <sub>e</sub> (A)	0.16	0.25	0.4	0.63	1	1.6	2.5	4	6	8	10	13	17	22	26	32
<b>Switching of standard three-phase motors AC-2, AC-3</b>																
230/240V (kW)	-	0.03	0.06	0.09	0.12	0.18/0.25	0.37	0.55/0.75	1.1/1.5	1.5	2.2/3	3	3.7/4	4	5.5	7.5
400/415V (kW)	0.02	0.06	0.09	0.12	0.18/0.25	0.37/0.55	0.75	1.1/1.5	2.2	3	3.7/4	5.5	7.5	7.5	11	15
500V (kW)	-	-	-	0.25	0.37	0.55/0.75	1.1	1.5/2.2	3	3.7	4/5.5	7.5	11	11	15	18.5
690V (kW)	-	-	-	0.25	0.37/0.55	0.75/1.1	1.5	2.2/3	3.7/4	5.5	7.5	11	11	15	18.5	22
<b>Back-up fuses gG, gL, only if I<sub>cc</sub> &gt; I<sub>cu</sub> (* = no back up fuse required)</b>																
230/240V (A)	*	*	*	*	*	*	*	*	*	*	*	*	*	*	*	*
400/415V (A)	*	*	*	*	*	*	*	*	*	*	*	*	100	125	125	125
440/460V (A)	*	*	*	*	*	*	*	*	*	80	80	80	80	100	100	100
500V (A)	*	*	*	*	*	*	*	*	*	63	80	80	80	80	80	80
690V (A)	*	*	*	*	*	*	35	40	50	63	63	63	63	63	63	63



### MPX<sup>3</sup> 32MA

Rated operational current I <sub>e</sub> (A)	0.16	0.25	0.4	0.63	1	1.6	2.5	4	6	8	10	13	17	22	26	32
<b>AC-2, AC-3</b>																
230/240V (kW)	-	0.03	0.06	0.09	0.12	0.18/0.25	0.37	0.55/0.75	1.1/1.5	1.5	2.2/3	3	3.7/4	4	5.5	7.5
400/415V (kW)	0.02	0.06	0.09	0.12	0.18/0.25	0.37/0.55	0.75	1.1/1.5	2.2	3	3.7/4	5.5	7.5	7.5	11	15
500V (kW)	-	-	-	0.25	0.37	0.55/0.75	1.1	1.5/2.2	3	3.7	4/5.5	7.5	11	11	15	18.5
690V (kW)	-	-	-	0.25	0.37/0.55	0.75/1.1	1.5	2.2/3	3.7/4	5.5	7.5	11	11	15	18.5	22
<b>Back-up fuses gG, gL, only if I<sub>cc</sub> &gt; I<sub>cu</sub> (* = no back up fuse required)</b>																
230/240V (A)	*	*	*	*	*	*	*	*	*	*	*	*	*	*	*	*
400/415V (A)	*	*	*	*	*	*	*	*	*	*	*	*	100	125	125	125
440/460V (A)	*	*	*	*	*	*	*	*	*	80	80	80	80	100	100	100
500V (A)	*	*	*	*	*	*	*	*	*	63	80	80	80	80	80	80
690V (A)	*	*	*	*	*	*	35	40	50	63	63	63	63	63	63	63

### MPX<sup>3</sup> 63H

Rated operational current I <sub>e</sub> (A)	10	13	17	22	26	32	40	50	63
<b>Switching of standard three-phase motors AC-2, AC-3</b>									
230/240V (kW)	2.2/3	3	3.7/4	4	5.5	7.5	7.5	11	15
400/415V (kW)	3.7/4	5.5	7.5	7.5	11	15	18.5	22	30
500V (kW)	4/5.5	7.5	11	11	15	18.5	22	30	37
690V (kW)	7.5	11	11	15	18.5	22	30	45	55
<b>Back-up fuses gG, gL, only if I<sub>cc</sub> &gt; I<sub>cu</sub> (* = no back up fuse required)</b>									
230/240V (A)	*	*	*	*	*	*	*	*	*
400/415V (A)	*	*	100	125	125	125	160	160	160
440/460V (A)	100	100	100	125	125	125	125	125	160
500V (A)	100	100	100	100	100	100	100	100	100
690V (A)	63	63	63	80	80	80	80	80	80



### MPX<sup>3</sup> 100H



Rated operational current I <sub>e</sub> (A)	17	22	26	32	40	50	63	75	90	100
<b>Switching of standard three-phase motors AC-2, AC-3</b>										
230/240V (kW)	3.7/4	4	5.5	7.5	7.5	11	15	22	30	30
400/415V (kW)	7.5	7.5	11	15	18.5	22	30	37	45	45
500V (kW)	11	11	15	18.5	22	30	37	45	55	63
690V (kW)	11	15	18.5	22	30	45	55	63	75	90
<b>Back-up fuses gG, gL, only if I<sub>cc</sub> &gt; I<sub>cu</sub> (* = no back up fuse required)</b>										
230/240V (A)	*	*	*	*	*	*	*	*	*	*
400/415V (A)	*	*	*	*	*	*	*	*	*	*
440/460V (A)	125	125	125	160	160	160	200	200	200	200
500V (A)	100	125	125	125	160	160	160	160	160	160
690V (A)	80	80	80	80	80	100	100	125	160	160













## 3-pole contactors CTX<sup>3</sup> and thermal overload relays RTX<sup>3</sup>

### technical characteristics

										
Contactor		CTX <sup>3</sup> 22				CTX <sup>3</sup> 40		CTX <sup>3</sup> 65		
	Size	2				3		4		
	Terminals type	screw				screw		screw or lug		
	Rated operational voltage, U <sub>e</sub>	690 V				690 V		690 V		
	Rated insulation voltage, U <sub>i</sub>	690 V				1000 V		1000 V		
	Rated frequency	50/60 Hz				50/60 Hz		50/60 Hz		
	Rated impulse withstand voltage, U <sub>imp</sub>	6 kV				8 kV		8 kV		
	Max. operating rate in operation cycle per hour (AC3)	1200				1800		1800		
Durability in millions of operations	Mechanical	15				12		12		
	Electrical	2.5				2		2		
	Type	9 A	12 A	18 A	22 A	32 A	40 A	50 A	65 A	
Current and power	AC-1	Thermal current (A)	25	25	40	40	50	60	70	100
		AC-3	200/240 V (kW)	2.5	3.5	4.5	5.5	7.5	11	15
	(A)		11	13	18	22	32	40	55	65
	380/440 V (kW)	(A)	4	5.5	7.5	11	15	18.5	22	30
		(A)	9	12	18	22	32	40	50	65
	500/550 V (kW)	(A)	4	7.5	7.5	15	18.5	22	30	33
		(A)	7	12	13	20	28	32	43	60
	690 V (kW)	(A)	4	7.5	7.5	15	18.5	22	30	33
		(A)	5	9	9	18	20	23	28	35
	UL rating 50/60 Hz	Continuous current (A)		25	25	40	40	50	60	70
Single phase		110/220 V (HP)	0.5	0.75	1	2	2	3	3	5
		220/240 V (HP)	1.5	2	3	3	5	7.5	10	15
Three phase		200/208 V (HP)	2	3	5	7.5	7.5	15	20	25
		220/240 V (HP)	3	5	7.5	10	10	15	25	30
		440/480 V (HP)	5	7.5	10	15	20	30	40	50
550/600 V (HP)		7.5	10	15	20	25	30	50	60	
NEMA size		00	00	0	1	1	1	2	2	
Weight and size	Weight (kg)		0.34				0.4		0.9	
	AC control	Size (W x H x D) (mm)	45 × 73.5 × 87.4				45 × 83 × 90		55 × 106 × 119	
		Weight (kg)		0.41				0.6		1.2
	DC control	Size (W x H x D) (mm)	45 × 73.5 × 103.6				45 × 83 × 117.1		55 × 106 × 146.4	
Integrated auxiliary contacts		1 NO + 1 NC				2 NO + 2 NC		2 NO + 2 NC		
Add on auxiliary block	Side mounting		Yes				Yes		Yes	
	Front mounting		Yes				Yes		Yes	

Thermal overload relay		RTX <sup>3</sup> 40				RTX <sup>3</sup> 40		RTX <sup>3</sup> 65		
										
Terminals type	Non differential RTX <sup>3</sup>	screw				screw		screw		
	Differential RTX <sup>3</sup>	screw				screw		lug		
	Rated operational voltage, U <sub>e</sub>	690 V				690 V		690 V		
	Rated insulation voltage, U <sub>i</sub>	690 V				690 V		690 V		
	Rated impulse withstand voltage, U <sub>imp</sub>	6 kV				6 kV		6 kV		
	Trip class	10 A				10 A		10 A		
	Setting	0.1 to 40 A				0.1 to 40 A		9 to 65 A		
Weight and size	Weight (kg)		0.17				0.17		0.31/0.33	
	Size (W x H x D) (mm)		45 × 75 × 90				45 × 75 × 90		55 × 81 × 100	

														
CTX³ 100			CTX³ 150			CTX³ 225			CTX³ 400			CTX³ 800		
5			6			7			8			9		
screw or lug			screw or lug			screw			screw			screw		
690 V			690 V			690 V			690 V			690 V		
1000 V			1000 V			1000 V			1000 V			1000 V		
50/60 Hz			50/60 Hz			50/60 Hz			50/60 Hz			50/60 Hz		
8 kV			8 kV			8 kV			8 kV			8 kV		
1800			1200			1200			1200			1200		
12			5			5			5		2.5	2.5		
2			1			1			1		0.5	0.5		
75 A	85 A	100 A	130 A	150 A	185 A	225 A	265 A	330 A	400 A	500 A	630 A	800 A		
110	135	160	160	210	230	275	300	350	450	580	660	900		
22	25	30	37	45	55	75	80	90	125	147	190	220		
75	85	105	130	150	185	225	265	330	400	500	630	800		
37	45	55	60	75	90	132	147	160	200	265	330	440		
75	85	105	130	150	185	225	265	330	400	500	630	800		
37	45	55	60	70	110	132	147	160	225	265	330	500		
64	75	85	90	100	180	200	225	280	350	400	500	720		
37	45	55	55	55	110	140	160	200	250	300	400	500		
42	45	65	60	60	120	150	185	225	300	380	420	630		
110	135	160	160	210	230	275	300	350	450	580	660	900		
5	7.5	10	10	15	15	15	-	-	-	-	-	-		
15	15	20	20	25	30	40	-	-	-	-	-	-		
25	30	30	40	40	60	60	75	100	125	150	200	200		
30	40	40	40	50	60	75	100	125	150	200	250	300		
50	60	75	75	100	125	150	200	250	300	400	500	600		
60	75	75	75	75	125	150	200	250	300	400	500	600		
2	3	3	3	4	4	4	5	5	5	6	6	7		
1.6			2.4			5.4			9.2			22.4		
70 × 140 × 135.8			95 × 158 × 130.3			138 × 203 × 185.1			163 × 243 × 204.4			285 × 312 × 245.3		
2.6			2.4			5.4			9.2			22.4		
70 × 140 × 172.3			95 × 158 × 130.3			138 × 203 × 185.1			163 × 243 × 204.4			285 × 312 × 245.3		
2 NO + 2 NC			2 NO + 2 NC			2 NO + 2 NC			2 NO + 2 NC			2 NO + 2 NC		
Yes			Yes			Yes			Yes			Yes		
Yes			Yes			No			No			No		

														
RTX³ 100			RTX³ 150			RTX³ 225			RTX³ 400			RTX³ 800		
screw			screw			-			-			-		
lug			lug			screw			screw			screw		
690 V			690 V			690 V			690 V			690 V		
690 V			690 V			690 V			690 V			690 V		
6 kV			6 kV			6 kV			6 kV			6 kV		
10 A			10 A			10 A			10 A			10 A		
18 to 100 A			45 to 150 A			65 to 240 A			85 to 400 A			200 to 800 A		
0.48/0.5			0.67			2.5			2.6			11.5		
70 × 97 × 110			95 × 109 × 113			147 × 141 × 184			151 × 171 × 198			360 × 530 × 212		

# 3-pole contactors CTX<sup>3</sup>

9 A to 100 A industrial contactors

**N** AVAILABLE  
SEPT 2014



4 160 96      4 161 26      4 161 46      4 161 56      4 161 86      4 161 96

Technical characteristics **p. 175-177**  
Dimensions and coordination with circuit breakers **see e-catalogue**

Conform to IEC 60947-1, IEC 60947-4-1  
Can be equipped with RTX<sup>3</sup> thermal relays (p. 172) add-on auxiliary contact blocks, time delay blocks, capacitor switching units and CTX<sup>3</sup> interlocking (p. 174)

Pack	Cat.Nos	CTX <sup>3</sup> 22		
		With integrated auxiliary contacts Power terminals: screw terminals		
		<b>9 A</b>		
		Max. operating current AC 3	Control Voltage	Integrated auxiliary contacts
1	4 160 80	9 A	24 V $\sim$	1 NO + 1 NC
1	4 160 81	9 A	24 V $\equiv$	1 NO + 1 NC
1	4 160 84	9 A	110 V $\sim$	1 NO + 1 NC
1	4 160 86	9 A	230 V $\sim$	1 NO + 1 NC
1	4 160 89	9 A	415 V $\sim$	1 NO + 1 NC
		<b>12 A</b>		
1	4 160 90	12 A	24 V $\sim$	1 NO + 1 NC
1	4 160 91	12 A	24 V $\equiv$	1 NO + 1 NC
1	4 160 94	12 A	110 V $\sim$	1 NO + 1 NC
1	4 160 96	12 A	230 V $\sim$	1 NO + 1 NC
1	4 160 99	12 A	415 V $\sim$	1 NO + 1 NC
		<b>18 A</b>		
1	4 161 00	18 A	24 V $\sim$	1 NO + 1 NC
1	4 161 01	18 A	24 V $\equiv$	1 NO + 1 NC
1	4 161 04	18 A	110 V $\sim$	1 NO + 1 NC
1	4 161 06	18 A	230 V $\sim$	1 NO + 1 NC
1	4 161 09	18 A	415 V $\sim$	1 NO + 1 NC
		<b>22 A</b>		
1	4 161 10	22 A	24 V $\sim$	1 NO + 1 NC
1	4 161 11	22 A	24 V $\equiv$	1 NO + 1 NC
1	4 161 14	22 A	110 V $\sim$	1 NO + 1 NC
1	4 161 16	22 A	230 V $\sim$	1 NO + 1 NC
1	4 161 19	22 A	415 V $\sim$	1 NO + 1 NC
		<b>CTX<sup>3</sup> 40</b>		
		With integrated auxiliary contacts Power terminals: screw terminals		
		<b>32 A</b>		
		Max. operating current AC 3	Control Voltage	Integrated auxiliary contacts
1	4 161 20	32 A	24 V $\sim$	2 NO + 2 NC
1	4 161 21	32 A	24 V $\equiv$	2 NO + 2 NC
1	4 161 24	32 A	110 V $\sim$	2 NO + 2 NC
1	4 161 26	32 A	230 V $\sim$	2 NO + 2 NC
1	4 161 29	32 A	415 V $\sim$	2 NO + 2 NC
		<b>40 A</b>		
1	4 161 30	40 A	24 V $\sim$	2 NO + 2 NC
1	4 161 31	40 A	24 V $\equiv$	2 NO + 2 NC
1	4 161 34	40 A	110 V $\sim$	2 NO + 2 NC
1	4 161 36	40 A	230 V $\sim$	2 NO + 2 NC
1	4 161 39	40 A	415 V $\sim$	2 NO + 2 NC

Pack	Cat.Nos		CTX <sup>3</sup> 65		
			With integrated auxiliary contacts		
			<b>50 A</b>		
			Max. operating current AC 3	Control Voltage	Integrated auxiliary contacts
1	Screw terminals	Lug terminals	50 A	24 V $\sim$	2 NO + 2 NC
1	4 161 40	4 161 50	50 A	24 V $\equiv$	2 NO + 2 NC
1	4 161 41	4 161 51	50 A	110 V $\sim$	2 NO + 2 NC
1	4 161 44	4 161 54	50 A	230 V $\sim$	2 NO + 2 NC
1	4 161 46	4 161 56	50 A	415 V $\sim$	2 NO + 2 NC
1	4 161 49	4 161 59	50 A	415 V $\sim$	2 NO + 2 NC
			<b>65 A</b>		
1	4 161 60	4 161 70	65 A	24 V $\sim$	2 NO + 2 NC
1	4 161 61	4 161 71	65 A	24 V $\equiv$	2 NO + 2 NC
1	4 161 64	4 161 74	65 A	110 V $\sim$	2 NO + 2 NC
1	4 161 66	4 161 76	65 A	230 V $\sim$	2 NO + 2 NC
1	4 161 69	4 161 79	65 A	415 V $\sim$	2 NO + 2 NC
			<b>CTX<sup>3</sup> 100</b>		
			With integrated auxiliary contacts		
			<b>75 A</b>		
			Max. operating current AC 3	Control Voltage	Integrated auxiliary contacts
1	Screw terminals	Lug terminals	75 A	24 V $\sim$	2 NO + 2 NC
1	4 161 80	4 161 90	75 A	24 V $\equiv$	2 NO + 2 NC
1	4 161 81	4 161 91	75 A	110 V $\sim$	2 NO + 2 NC
1	4 161 84	4 161 94	75 A	230 V $\sim$	2 NO + 2 NC
1	4 161 86	4 161 96	75 A	415 V $\sim$	2 NO + 2 NC
1	4 161 89	4 161 99	75 A	415 V $\sim$	2 NO + 2 NC
			<b>85 A</b>		
1	4 162 00	4 162 10	85 A	24 V $\sim$	2 NO + 2 NC
1	4 162 01	4 162 11	85 A	24 V $\equiv$	2 NO + 2 NC
1	4 162 04	4 162 14	85 A	110 V $\sim$	2 NO + 2 NC
1	4 162 06	4 162 16	85 A	230 V $\sim$	2 NO + 2 NC
1	4 162 09	4 162 19	85 A	415 V $\sim$	2 NO + 2 NC
			<b>100 A</b>		
1	4 162 20	4 162 30	100 A	24 V $\sim$	2 NO + 2 NC
1	4 162 21	4 162 31	100 A	24 V $\equiv$	2 NO + 2 NC
1	4 162 24	4 162 34	100 A	110 V $\sim$	2 NO + 2 NC
1	4 162 26	4 162 36	100 A	230 V $\sim$	2 NO + 2 NC
1	4 162 29	4 162 39	100 A	415 V $\sim$	2 NO + 2 NC

Add-on auxiliary contact blocks **p. 174**



For dimensions, wiring capacity and coordination with circuit breakers **see e-catalogue**



# 3-pole contactors CTX<sup>3</sup>

130 A to 800 A industrial contactors

**N** AVAILABLE  
SEPT 2014



4 162 46



4 162 56



4 162 96



4 163 56

Technical characteristics **p. 175-177**  
Dimensions and coordination with circuit breakers **see e-catalogue**

Conform to IEC 60947-1, IEC 60947-4-1

Can be equipped with RTX<sup>3</sup> thermal relays (p. 172-173) add-on auxiliary contact blocks, time delay blocks (except CTX<sup>3</sup> 225/400/800) and CTX<sup>3</sup> interlocking (p. 174)

Pack	Cat.Nos		<b>CTX<sup>3</sup> 150</b>		
			With integrated auxiliary contacts		
			<b>130 A</b>		
	Screw terminals	Lug terminals	Max. operating current AC 3	Control Voltage	Integrated auxiliary contacts
1	4 162 40	4 162 50	130 A	24 V $\sim$	2 NO + 2 NC
1	4 162 41	4 162 51	130 A	24 V $\equiv$	2 NO + 2 NC
1	4 162 46	4 162 56	130 A	100-240 V $\sim/\equiv$	2 NO + 2 NC
1	4 162 49	4 162 59	130 A	400-440 V $\sim$	2 NO + 2 NC
			<b>150 A</b>		
1	4 162 60	4 162 70	150 A	24 V $\sim$	2 NO + 2 NC
1	4 162 61	4 162 71	150 A	24 V $\equiv$	2 NO + 2 NC
1	4 162 66	4 162 76	150 A	100-240 V $\sim/\equiv$	2 NO + 2 NC
1	4 162 69	4 162 79	150 A	400-440 V $\sim$	2 NO + 2 NC

Pack	Cat.Nos		<b>CTX<sup>3</sup> 225</b>		
			With integrated auxiliary contacts		
			<b>185 A</b>		
	Screw terminals		Max. operating current AC 3	Control Voltage	Integrated auxiliary contacts
1	4 162 80		185 A	24 V $\sim/\equiv$	2 NO + 2 NC
1	4 162 86		185 A	100-240 V $\sim/\equiv$	2 NO + 2 NC
1	4 162 89		185 A	380-450 V $\sim$	2 NO + 2 NC
			<b>225 A</b>		
1	4 162 90		225 A	24 V $\sim/\equiv$	2 NO + 2 NC
1	4 162 96		225 A	100-240 V $\sim/\equiv$	2 NO + 2 NC
1	4 162 99		225 A	380-450 V $\sim$	2 NO + 2 NC

Pack	Cat.Nos		<b>CTX<sup>3</sup> 400</b>		
			With integrated auxiliary contacts		
			<b>265 A</b>		
	Screw terminals		Max. operating current AC 3	Control Voltage	Integrated auxiliary contacts
1	4 163 06		265 A	100-240 V $\sim/\equiv$	2 NO + 2 NC
1	4 163 09		265 A	380-450 V $\sim$	2 NO + 2 NC
			<b>330 A</b>		
1	4 163 16		330 A	100-240 V $\sim/\equiv$	2 NO + 2 NC
1	4 163 19		330 A	380-450 V $\sim$	2 NO + 2 NC
			<b>400 A</b>		
1	4 163 26		400 A	100-240 V $\sim/\equiv$	2 NO + 2 NC
1	4 163 29		400 A	380-450 V $\sim$	2 NO + 2 NC

Pack	Cat.Nos	<b>CTX<sup>3</sup> 800</b>		
		With integrated auxiliary contacts		
		<b>500 A</b>		
	Screw terminals	Max. operating current AC 3	Control Voltage	Integrated auxiliary contacts
1	4 163 36	500 A	200-240 V $\sim/\equiv$	2 NO + 2 NC
1	4 160 39	500 A	380-450 V $\sim$	2 NO + 2 NC
		<b>630 A</b>		
1	4 163 46	630 A	200-240 V $\sim/\equiv$	2 NO + 2 NC
1	4 163 49	630 A	380-450 V $\sim$	2 NO + 2 NC
		<b>800 A</b>		
1	4 163 56	800 A	200-240 V $\sim/\equiv$	2 NO + 2 NC
1	4 163 59	800 A	380-450 V $\sim$	2 NO + 2 NC

Add-on auxiliary contact blocks **p. 174**



Mini contactors 6 to 16 A, spare coils  
**Please, consult us**

# Thermal relays RTX<sup>3</sup>

for CTX<sup>3</sup> 3-pole industrial contactors

**N** AVAILABLE  
SEPT 2014



Technical characteristics **p. 175-177**  
Dimensions and coordination with circuit breakers **see e-catalogue**

Thermal protection against overloads, long starting times and lasting stalling of the motor  
Differential type ensures a better protection in case of one phase failure thanks to faster tripping  
Conform to IEC 60 947-1, IEC 60 947-4-1

Pack	Cat. Nos		Thermal overload relays		
			Class 10A Integrated auxiliary contacts 1 NO + 1 NC		
			<b>RTX<sup>3</sup> 40</b>		
			For CTX <sup>3</sup> 22 and 40 With screw terminals		
			Adjustment range		
	Type		I min. (A)	I max. (A)	
	non diff.	diff.			
1	4 166 40	4 166 60	0.1	0.16	
1	4 166 41	4 166 61	0.16	0.25	
1	4 166 42	4 166 62	0.25	0.4	
1	4 166 43	4 166 63	0.4	0.63	
1	4 166 44	4 166 64	0.63	1	
1	4 166 45	4 166 65	1	1.6	
1	4 166 46	4 166 66	1.6	2.5	
1	4 166 47	4 166 67	2.5	4	
1	4 166 48	4 166 68	4	6	
1	4 166 49	4 166 69	5	8	
1	4 166 50	4 166 70	6	9	
1	4 166 51	4 166 71	7	10	
1	4 166 52	4 166 72	9	13	
1	4 166 53	4 166 73	12	18	
1	4 166 54	4 166 74	16	22	
1	4 166 55	4 166 75	18	25	
1	4 166 56	4 166 76	22	32	
1	4 166 57	4 166 77	28	40	
			<b>RTX<sup>3</sup> 65</b>		
			For CTX <sup>3</sup> 65 Non differential type with screw terminals Differential type with lug terminals		
1	4 166 83	4 167 03	9	13	
1	4 166 84	4 167 04	12	18	
1	4 166 85	4 167 05	16	22	
1	4 166 86	4 167 06	18	25	
1	4 166 87	4 167 07	24	36	
1	4 166 88	4 167 08	28	40	
1	4 166 89	4 167 09	34	50	
1	4 166 90	4 167 10	45	65	

Pack	Cat. Nos		Thermal overload relays (continued)		
			Class 10A Integrated auxiliary contacts 1 NO + 1 NC		
			<b>RTX<sup>3</sup> 100</b>		
			For CTX <sup>3</sup> 100 Non differential type with screw terminals Differential type with lug terminals		
			Adjustment range		
	Type		I min. (A)	I max. (A)	
	non diff.	diff.			
1	4 167 23	4 167 43	18	25	
1	4 167 24	4 167 44	24	36	
1	4 167 25	4 167 45	28	40	
1	4 167 26	4 167 46	34	50	
1	4 167 27	4 167 47	45	65	
1	4 167 28	4 167 48	54	75	
1	4 167 29	4 167 49	63	85	
1	4 167 30	4 167 50	70	95	
1	4 167 31	4 167 51	80	100	
			<b>RTX<sup>3</sup> 150</b>		
			For CTX <sup>3</sup> 150 Non differential type with screw terminals Differential type with lug terminals		
1	4 167 60	4 167 70	45	65	
1	4 167 61	4 167 71	54	75	
1	4 167 62	4 167 72	63	85	
1	4 167 63	4 167 73	80	105	
1	4 167 64	4 167 74	95	130	
1	4 167 65	4 167 75	110	150	
			<b>Separate mounting units</b>		
			To mount the relays separately from contactors, on DIN rail or panel by fixing screws		
1	4 165 91		For RTX <sup>3</sup> 40 up to 32 A		
1	4 165 92		For RTX <sup>3</sup> 40 40 A		
1	4 165 93		For RTX <sup>3</sup> 65 with screw terminals		
1	4 165 94		For RTX <sup>3</sup> 65 with lug terminals		
1	4 165 95		For RTX <sup>3</sup> 100 with screw terminals		
1	4 165 96		For RTX <sup>3</sup> 100 with lug terminals		
1	4 165 97		For RTX <sup>3</sup> 150 with screw terminals		
1	4 165 98		For RTX <sup>3</sup> 150 with lug terminals		



## Thermal relays RTX<sup>3</sup>

for CTX<sup>3</sup> 3-pole industrial contactors

**N** AVAILABLE  
SEPT 2014

## 4-pole contactors CTX<sup>3</sup>

22 A to 800 A industrial contactors

**N** AVAILABLE  
SEPT 2014



4 167 84

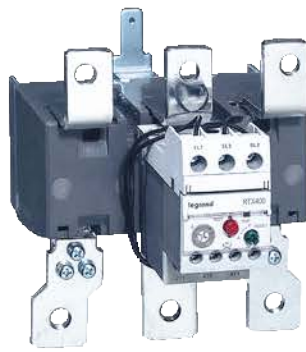

4 167 91



4 164 36



4 164 56



4 164 86

Technical characteristics **p. 175-177**  
Dimensions and coordination with circuit breakers **see e-catalogue**

Conform to IEC 60 947-1, IEC 60 947-4-1

Technical characteristics **p. 175-177**  
Dimensions and coordination with circuit breakers **see e-catalogue**

Conform to IEC 60 947-1, IEC 60 947-4-1

Pack	Cat. Nos	Thermal overload relays		
		Class 10A Integrated auxiliary contacts 1 NO + 1 NC		
		<b>RTX<sup>3</sup> 225</b>		
		For CTX <sup>3</sup> 225 With screw terminals		
		Type diff	Adjustment range	
			I min. (A)   I max. (A)	
1	4 167 80		65   100	
1	4 167 81		85   125	
1	4 167 82		100   160	
1	4 167 83		120   185	
1	4 167 84		160   240	
		<b>RTX<sup>3</sup> 400</b>		
		For CTX <sup>3</sup> 400 With screw terminals		
1	4 167 86		85   125	
1	4 167 87		100   160	
1	4 167 88		120   185	
1	4 167 89		160   240	
1	4 167 90		200   330	
1	4 167 91		260   400	
		<b>RTX<sup>3</sup> 800</b>		
		For CTX <sup>3</sup> 800 With screw terminals		
1	4 167 92		200   300	
1	4 167 93		260   400	
1	4 167 94		400   600	
1	4 167 95		520   800	
		<b>RTX<sup>3</sup> remote reset unit</b>		
		Flexible cable to reset the relay on the panel door For RTX <sup>3</sup> 40/65/100		
1	4 168 92	Length 400 mm		
1	4 168 93	Length 500 mm		
1	4 168 94	Length 600 mm		

Pack	Cat. Nos	Contactors CTX <sup>3</sup>		
		Power terminals: screw terminals		
		<b>Without integrated auxiliary contact</b>		
		Max. operating current AC 1	Max. operating current AC 3	Control Voltage
1	4 164 26	40 A	22 A	230 V~
1	4 164 36	60 A	40 A	230 V~
1	4 164 46	100 A	65 A	230 V~
1	4 164 56	135 A	85 A	230 V~
		<b>With integrated auxiliary contacts</b>		
		Auxiliary contacts: 2 NO + 2 NC		
1	4 164 66	155 A	120 A	100-240 V~/=
1	4 164 76	200 A	150 A	100-240 V~/=
1	4 164 86	260 A	225 A	100-240 V~/=
1	4 164 96	350 A	330 A	100-240 V~/=
1	4 165 06	420 A	400 A	100-240 V~/=
1	4 165 16	660 A	630 A	200-240 V~/=
1	4 165 26	800 A	800 A	200-240 V~/=

Mechanical interlocks  
**p. 174**



For dimensions of 4 pole contactors  
**see e-catalogue**





Technical characteristics **p. 175-177**  
 Dimensions **see e-catalogue**

Pack	Cat. Nos	CTX <sup>3</sup> add-on auxiliary contact blocks
		<b>Front mounting</b>
		For contactors CTX <sup>3</sup> 22/40/65/100/150 2 and 4 pole Ith: 16 A
1	4 168 50	1 NO + 1 NC
1	4 168 51	2 NO
1	4 168 52	2 NC
1	4 168 53	4 NO
1	4 168 54	3 NO + 1 NC
1	4 168 55	2 NO + 2 NC
1	4 168 56	1 NO + 3 NC
1	4 168 57	4 NC
		<b>Side mounting</b>
		2-pole Mounting on both sides
1	4 168 58	For contactors CTX <sup>3</sup> 22/40/65/100/150 1 NO + 1 NC - Ith: 16 A
1	4 168 59	For contactors CTX <sup>3</sup> 225/400/800 1 NO + 1 NC - Ith: 16 A
1	4 168 49	For contactors CTX <sup>3</sup> 4P from 40 A to 135 A (AC-1) 1 NO + 1 NC - Ith: 16 A
		<b>CTX<sup>3</sup> time delay blocks</b>
		For contactors CTX <sup>3</sup> 22/40/65/100/150 Time delay: 1 to 30 s Front mounting
		<b>On delay</b>
1	4 168 70	24-48 V $\sim$ /=
1	4 168 71	110-230 V $\sim$
		<b>Off delay</b>
1	4 168 72	24-48 V $\sim$ /=
1	4 168 73	110-230 V $\sim$
		<b>CTX<sup>3</sup> capacitor switching units</b>
1	4 168 74	6 to 40 A, for contactors CTX <sup>3</sup> 22/40 (technical characteristics and dimensions p. 177)
1	4 168 75	50 to 100 A, for contactors CTX <sup>3</sup> 65/100 (technical characteristics and dimensions p. 177)
		<b>CTX<sup>3</sup> interlocking</b>
		Component parts for assembling by customer Horizontal mounting
		<b>Interlock units</b>
1	4 168 79	Mechanical interlocks for CTX <sup>3</sup> 4P from 40 to 135 A (AC-3) (p. 173)
1	4 168 80	Mechanical interlocks for CTX <sup>3</sup> 22/40/65/100/150 (p. 170-171)
1	4 168 87	Provides 2 NC contacts for use in electrical interlocking Mechanical interlocks for CTX <sup>3</sup> 3P and 4P 180 to 400 A (p. 171 and 173)
1	4 168 88	Mechanical interlocks for CTX <sup>3</sup> 3P 500 to 800 A (p. 171)
1	4 168 89	Mechanical interlocks for CTX <sup>3</sup> 4P 500 to 800 A (p. 173)
		<b>Wire kits</b>
		Used for making reversing between two contactors
1	4 168 82	For CTX <sup>3</sup> 22
1	4 168 83	For CTX <sup>3</sup> 40
1	4 168 84	For CTX <sup>3</sup> 65
1	4 168 85	For CTX <sup>3</sup> 100

Pack	Cat. Nos	Boxes for motor starter
1	4 168 90	For CTX <sup>3</sup> 22 equipped with RTX <sup>3</sup> 40 (0.1 - 22 A) Without pushbuttons
1	4 168 91	With pushbuttons
		<b>CTX<sup>3</sup> transient voltage suppressor blocks</b>
		Absorbs the surge arisen out of the coil of the contactor
1	4 168 95	24-48 V V $\sim$ /=
1	4 168 96	100-125 V $\sim$ /=
1	4 168 97	200-240 V $\sim$ /=
1	4 168 98	380-400 V $\sim$
		<b>CTX<sup>3</sup> terminals covers</b>
1	4 168 42	For CTX <sup>3</sup> 225 3P
1	4 168 43	For CTX <sup>3</sup> 400 3P
1	4 168 44	For CTX <sup>3</sup> 800 3P
1	4 168 45	For CTX <sup>3</sup> 225 4P
1	4 168 46	For CTX <sup>3</sup> 400 4P
1	4 168 47	For CTX <sup>3</sup> 800 4P
		<b>CTX<sup>3</sup> safety front cover</b>
1	4 168 40	For CTX <sup>3</sup> 22/40/65/100/150
1	4 168 41	For CTX <sup>3</sup> 225/400/800



# Control relays CTX<sup>3</sup>



# Contactors CTX<sup>3</sup>

## technical characteristics



4 168 10

Technical characteristics p. 175-177  
Dimensions see e-catalogue

Pack	Cat. Nos	CTX <sup>3</sup> control relays
		4-pole Conform to IEC 60 947 I <sub>th</sub> = 16 A Low consumption coil
		<b>4 NO</b>
1	4 168 00	24 V~
1	4 168 01	24 V=
1	4 168 04	110 V~
1	4 168 06	230 V~
1	4 168 09	415 V~
		<b>3 NO + 1 NC</b>
1	4 168 10	24 V~
1	4 168 11	24 V=
1	4 168 14	110 V~
1	4 168 16	230 V~
1	4 168 19	415 V~
		<b>2 NO + 2 NC</b>
1	4 168 20	24 V~
1	4 168 21	24 V=
1	4 168 24	110 V~
1	4 168 26	230 V~
1	4 168 29	415 V~

### Accessory

#### Interlock unit, Cat.No 4 168 80

The mechanical interlock unit provides 2NC contacts for use in electrical interlocking of two contactors

#### Wire kits

Used for making reversing circuit between two contactors

Contactor	Wire kit		Interlock unit	
	Cat.No	Weight	Cat.No	Weight
CTX <sup>3</sup> 22	4 168 82	0.04 kg	4 168 80	0.06 kg
CTX <sup>3</sup> 40	4 168 83	0.05 kg		
CTX <sup>3</sup> 65	4 168 84	0.12 kg		
CTX <sup>3</sup> 100	4 168 85	0.33 kg		
CTX <sup>3</sup> 150	-	-		

### Rating of the contacts in the interlocks

Rated operation voltage (V)	600	
Rated insulation voltage (V)	600	
Rated frequency (Hz)	50/60	
Rated thermal current (A)	10	
Rated operation current (A)		
AC15 duty (A600)	120 V	6
	240 V	3
	380 V	1.9
	480 V	1.5
	500 V	1.4
	600 V	1.2
DC13 duty (Q300)	125 V	0.55
	250 V	0.27

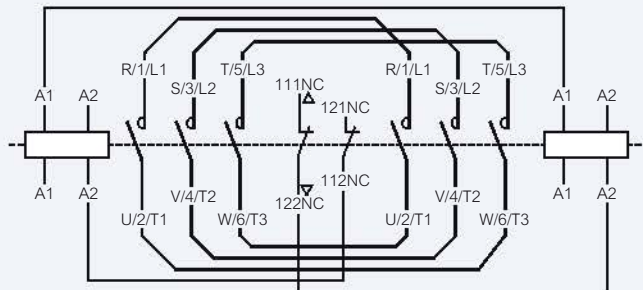

CTX<sup>3</sup> 9 A - 150 A typical circuit diagram for reversing contactor

### Time delay blocks Cat.No 4 168 70/71/72/73

Applying contactors	Cat.No	Rated voltage	Performance
CTX <sup>3</sup> 22 to CTX <sup>3</sup> 150	On delay	4 168 70	AC/DC 24 to 48 V
		4 168 71	AC 110 to 230 V
	Off delay	4 168 72	AC/DC 24 to 48 V
		4 168 73	AC 110 to 230 V

- Mounting: Head on
- Contact: 1 NC
- Time delay: 1s to 30s On delay, Off delay
- Frequency: AC 50/60 hz
- Operation: Min. voltage 85%  
Max. voltage 110%
- Accuracy of setting time: ± 20 %

# Contactors CTX<sup>3</sup>

## technical characteristics

### ■ Type 2 coordination with MPCBs MPX<sup>3</sup>

According to IEC 60947-4-1

Short circuit current I<sub>q</sub> = 50 kA

Voltage 400/415 V~ 50/60 Hz

Standard motors AC-3 at 400/415 V 1500 rpm		MPCB type		Manual motor starter		Contactor	
Rated Power (kW)	Current (A)	Type	Rating (A)	Thermal overload release setting range (A)	Magnetic release response current (A)	Contactor	
						Type	Rating (A)
-	-	MPX <sup>3</sup> 32S	0.16	0.1 - 0.16	2.08	CTX <sup>3</sup> 22	9
0.06	0.20	MPX <sup>3</sup> 32S	0.25	0.16 - 0.25	3.25	CTX <sup>3</sup> 22	9
0.09	0.30	MPX <sup>3</sup> 32S	0.40	0.25 - 0.4	5.2	CTX <sup>3</sup> 22	9
0.12	0.40	MPX <sup>3</sup> 32S	0.63	0.4 - 0.63	8.19	CTX <sup>3</sup> 22	9
0.18	0.60	MPX <sup>3</sup> 32S	0.63	0.4 - 0.63	8.19	CTX <sup>3</sup> 22	9
0.25	0.80	MPX <sup>3</sup> 32S	1	0.63 - 1	13	CTX <sup>3</sup> 22	9
0.37	1.1	MPX <sup>3</sup> 32S	1.6	1 - 1.6	20.8	CTX <sup>3</sup> 22	9
0.55	1.5	MPX <sup>3</sup> 32S	1.6	1 - 1.6	20.8	CTX <sup>3</sup> 22	9
0.75	1.9	MPX <sup>3</sup> 32S	2.5	1.6 - 2.5	32.5	CTX <sup>3</sup> 22	12
1.1	2.7	MPX <sup>3</sup> 32S	4	2.5 - 4	52	CTX <sup>3</sup> 22	18
1.5	3.6	MPX <sup>3</sup> 32S	4	2.5 - 4	52	CTX <sup>3</sup> 22	18
2.2	5.2	MPX <sup>3</sup> 32S	6	4 - 6	78	CTX <sup>3</sup> 22	18
3	6.8	MPX <sup>3</sup> 32S	8	5 - 8	104	CTX <sup>3</sup> 22	18
4	9	MPX <sup>3</sup> 32S	10	6 - 10	130	CTX <sup>3</sup> 22	18
5.5	11.5	MPX <sup>3</sup> 32H	13	9 - 13	169	CTX <sup>3</sup> 22	22
7.5	15.5	MPX <sup>3</sup> 32H	17	11 - 17	221	CTX <sup>3</sup> 22	22
10	20	MPX <sup>3</sup> 32H	22	14 - 22	286	CTX <sup>3</sup> 40	32
11	22	MPX <sup>3</sup> 32H	25	18 - 26	338	CTX <sup>3</sup> 40	32
15	29	MPX <sup>3</sup> 32H	32	22 - 32	416	CTX <sup>3</sup> 40	32
18.5	35	MPX <sup>3</sup> 63H	40	28 - 40	520	CTX <sup>3</sup> 65	50
22	41	MPX <sup>3</sup> 63H	50	34 - 50	650	CTX <sup>3</sup> 65	50
30	55	MPX <sup>3</sup> 63H	63	45 - 63	819	CTX <sup>3</sup> 65	65
37	67	MPX <sup>3</sup> 100H	75	55 - 75	975	CTX <sup>3</sup> 100	75
-	-	MPX <sup>3</sup> 100H	90	70 - 90	1170	CTX <sup>3</sup> 100	85
45	80	MPX <sup>3</sup> 100H	100	80 - 100	1300	CTX <sup>3</sup> 100	85

#### Definition type 2 coordination according to IEC 947-4-1:

- The contactor or the starter must not endanger persons or systems in the event of a short-circuit.
- The contactor or the starter must be suitable for further use.
- No damage to the overload relay or other parts may occur with the exception of welding of the contactor or starter contacts provided that these can be easily separated without significant deformation (such as with a screwdriver).

### ■ CTX<sup>3</sup> capacitor switching units Cat.No 4 168 74/75

Capacitor unit is connected to the terminals of the contactor to reduce the high inrush current.  
IEC 60947-4-1 AC 6b

Type	Contactor		Maximum operating power (kvar)			Max. Peak current (A)
			220 - 240 V	400 - 440 V	500 - 550 V	
4 168 74	CTX <sup>3</sup> 22	9 A	5	9.7	14	560
	CTX <sup>3</sup> 22	12 A	6.7	12.5	18	560
	CTX <sup>3</sup> 22	18 A	8.5	16.7	24	850
	CTX <sup>3</sup> 22	22 A	10	18	26	1250
	CTX <sup>3</sup> 40	32 A	15	25	36	1900
	CTX <sup>3</sup> 40	40 A	20	33.3	48	2160
4 168 75	CTX <sup>3</sup> 65	50 A	20	40	58	2160
	CTX <sup>3</sup> 65	65 A	25	45.7	66	3040
	CTX <sup>3</sup> 100	75 A	29.7	54	78	3040
	CTX <sup>3</sup> 100	85 A	35	60	92	3040
	CTX <sup>3</sup> 100	100 A	37	62	94	3040

Note: - When the switch is closed capacitor must be discharged before recharged. (Maximum residual voltage at terminals  $\leq 50$  V)  
- To prevent short current, gG type fuse must be 1.5 - 2 times than rated current

### Features of capacitor unit (Pre-loading resistor)

- Damping resistor that can limit the inrush current up to  $60 \times I_n$  by closing earlier than the main contact of the contactor
- No heat loss by the serial resistor
- Eliminates the switching surge
- Improves the performance of the capacitor system

### Operation sequence

Capacitor unit: OFF  
Contactor: OFF

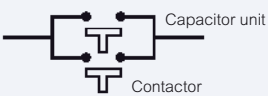

Fig.1

Capacitor unit: ON  
Contactor: OFF

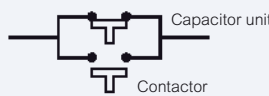

Fig.2

Capacitor unit: OFF  
Contactor: ON

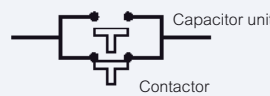
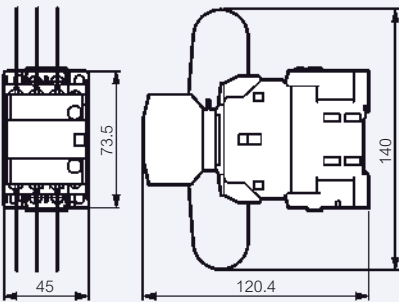

Fig.3

Note - Closing sequence: Fig.1 => Fig.2 => Fig.3  
Opening sequence: Fig.3 => Fig.1

### Overall dimensions of contactors equipped with CTX<sup>3</sup> switching units

Cat.No 4 168 74 on CTX<sup>3</sup> 22



Cat.No 4 168 75 on CTX<sup>3</sup> 65

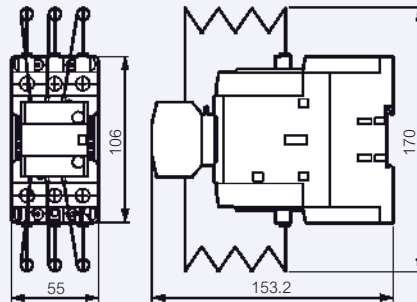

Cat.No 4 168 74 on CTX<sup>3</sup> 40

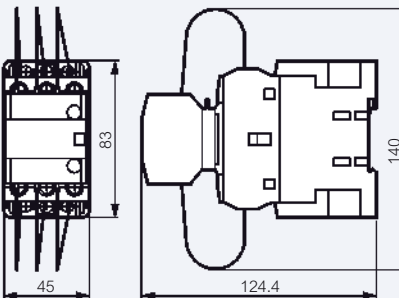

Cat.No 4 168 75 on CTX<sup>3</sup> 100

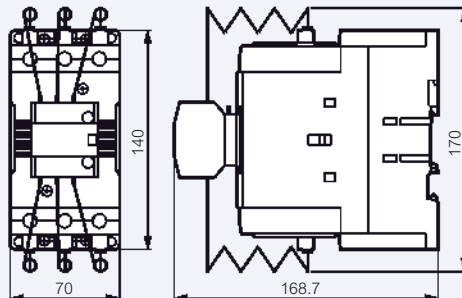

## Supply busbars and distribution blocks

### SUPPLY BUSBARS FROM 63 TO 90 A

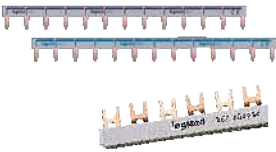
<p>• Isc peak 17 kA</p> 	Lenght	Universal 1-pole + neutral or 1-pole	2-pole	2-pole balanced on 3-phase	3-pole	4-pole
	Prong-type					
	1 row	4 049 26	4 049 38	4 049 40	4 049 42	4 049 44
	meter	4 049 37	4 049 39	4 049 41	4 049 43	4 049 45
	Fork-type					
	1 row	4 049 11	-		4 049 17	-
meter	4 049 12	4 049 14		4 049 18	4 049 20	

### DISTRIBUTION TERMINAL BLOCKS FROM 63 TO 100 A

<p>• Isc peak 10 kA</p> 	Number of outputs	Bar terminal blocks		Insulated terminal blocks IP 2X (XXB)		
		with screws	on support	black	blue	green
	4	0 048 01	0 048 20	0 048 50	0 048 40	0 048 30
	6			0 048 16	0 048 15	
	8	0 048 03	0 048 22	0 048 52	0 048 42	0 048 32
	12		0 048 24	0 048 54	0 048 44	0 048 34
	14	0 048 05				
	16		0 048 25		0 048 45	0 048 35
	19	0 048 06				
	21		0 048 26		0 048 46	0 048 36
24	0 048 07					
33		0 048 28		0 048 48	0 048 38	

### MODULAR DISTRIBUTION BLOCKS FROM 40 TO 250 A

<p>• Isc peak 14.5 to 42 kA</p> 	Admissible maximum rating (A)	2-pole			4-pole			Terminal blocks IP 2X		
		Number and section of flexible conductors (mm <sup>2</sup> )			Number and section of flexible conductors (mm <sup>2</sup> )			Additional outputs		
		Cat.Nos	Inputs	Outputs	Cat.Nos	Inputs	Outputs	Earth	Neutral	(mm <sup>2</sup> )
	40	0 048 81	2 x 10	11 x 4	0 048 85	2 x 10	11 x 4	0 048 34	0 048 44	12 x 6
	100	0 048 80	2 x 16	5 x 10	0 048 84	2 x 16	5 x 10	0 048 32	0 048 42	8 x 6
	125	0 048 82	2 x 25	2 x 16 + 11 x 10	0 048 88	2 x 25	2 x 25 + 11 x 10	0 048 35	0 048 45	16 x 6
					0 048 86	2 x 25	2 x 16 + 7 x 10	0 048 34	0 048 44	12 x 6
					0 048 76	1 x 35	1 x 25 + 1 x 16 + 14 x 10	0 048 36	0 048 46	21 x 6
	160				0 048 79	1 x 70	2 x 25 + 4 x 16 + 8 x 10	0 048 35	0 048 45	16 x 6
	250				0 048 77	1 x 120	1 x 35 + 2 x 25 + 2 x 16 + 6 x 10			

### SINGLE POLE MODULAR DISTRIBUTION BLOCKS AND DISTRIBUTION TERMINALS FROM 125 TO 250 A

<p>• Isc peak 27 to 60 kA</p> 	Admissible maximum rating (A)	Cat.Nos	Number and section of conductors per pole (mm <sup>2</sup> )	
			Inputs	Outputs
	125	0 048 71	4 x 35	12 x 10
	160	0 048 83	1 x 50 (flexible bar 13 mm max.)	3 x 25 + 2 x 16 + 7 x 10
		0 048 67 (distribution terminal)	Direct into the downstream terminal	6 x 25
250	0 048 73	1 x 120 (flexible bar 16 mm max.)	6 x 25 + 4 x 10	
	0 048 68 (distribution terminal)	Direct into the downstream terminal	4 x 35 + 2 x 25	

### POWER DISTRIBUTION BLOCKS FROM 125 TO 400 A

<p>• Isc peak 20 to 75 kA</p> 	Admissible maximum rating (A)	Extra-flat			Stepped		
		Number and section of conductors per pole (mm <sup>2</sup> )			Number and section of conductors per pole (mm <sup>2</sup> )		
		Cat.Nos	Inputs	Outputs	Cat.Nos	Inputs	Outputs
	125	0 374 47	1 x 35	10 x 16 (Ph) 17 x 16 (N)	0 373 95	4 bars 12 x 4 mm receiving 5 connectors 2 x 10 each	
					0 374 30	1 x 35	5 x 25
	160				0 374 31	1 x 70	5 x 35
	250	0 374 00	1 x 150	1 x 70 or 1 x 50 + 1 x 35 or 2 x 35	0 374 35	1 x 120	5 x 50
400				0 373 08	2 x Ø8.5 mm	21 holes M6 70 mm <sup>2</sup> max. connectors	
				0 374 42	2 x 185	15 holes M6 15 holes M8	

## Supply busbars, entry terminals

"standard" distribution

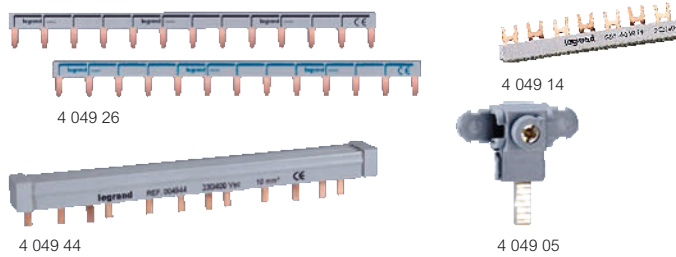

Pack	Cat.Nos	Prong-type supply busbars	
		<b>Universal single pole + neutral</b> Reversible: blue for neutral, black for live	
		Length	Max. number of devices connected
20	4 049 26	1 row	13
10	4 049 37	Meter	57
		<b>Double pole</b>	
50	4 049 38 <sup>1</sup>	1 row	6
10	4 049 39	Meter	28
		<b>Double pole balanced on 3 phases</b>	
3	4 049 40 <sup>1</sup>	1 row	6
10	4 049 41	Meter	28
		<b>Triple pole</b>	
40	4 049 42 <sup>1</sup>	1 row	4
10	4 049 43	Meter	19
		<b>Four pole</b>	
30	4 049 44	1 row	3
10	4 049 45	Meter	14

Pack	Cat.Nos	Fork-type supply busbars	
		<b>Single pole</b>	
		Length	Max. number of devices connected
20	4 049 11	1 row	12
10	4 049 12	Meter	57
		<b>Double pole</b>	
10	4 049 14	Meter	28
		<b>Triple pole</b>	
5	4 049 17	1 row	4
10	4 049 18	Meter	19
		<b>Four pole</b>	
10	4 049 20	Meter	14

Pack	Cat.Nos	Protection	
		<b>Protection of prongs</b>	
20	4 049 88	12 modules	Can be cut to length
		<b>Protection of supply busbar ends</b>	
40	4 049 89	For single pole/single pole + neutral	
20	4 049 90	For double pole length 1 m and triple pole	
20	4 049 91	For four-pole	

Pack	Cat.Nos	Entry terminals	
20	4 049 05	For universal single pole + neutral or single pole supply busbars Cross section: 4 to 25 mm <sup>2</sup> - IP 2X	
20	4 049 06	For all supply busbars Cross section: 6 to 35 mm <sup>2</sup>	

1: Filled with end protection

## Supply busbars, entry terminals

"standard" distribution

### Technical characteristics

	Busbars type	Max number of devices connected	Length in number of 17.5 mm modules	Cross section (mm <sup>2</sup> )	Permissible current	
					1 central power supply point	2 power supply point
Single pole or Single pole + neutral	1 row	13	13	16 <sup>2</sup>	80	100
	Meter	57	57			
Double pole	1 row	6	12	10 <sup>2</sup>	63	90
	Meter	28	56			
Double pole balanced on 3-phases	1 row	6	12	10 <sup>2</sup>	63	90
	Meter	28	56			
Triple pole	1 row	4	12	10 <sup>2</sup>	63	90
	Meter	19	57			
Four pole	1 row	3	12	10 <sup>2</sup>	63	90
	Meter	14	56			

### Use of supply busbars

#### Universal single phase + neutral

- blue for neutral  
- black for live

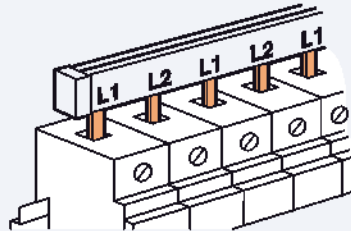

#### Entry terminal

Power supply at the rear of the busbar  
For all devices with moving cage terminals

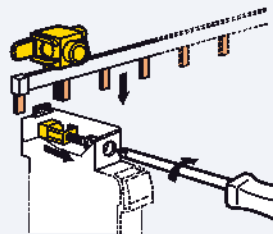

Power supply at the front of the busbar  
For all devices with fixed cage terminals

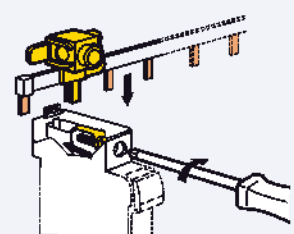

#### Four pole busbar

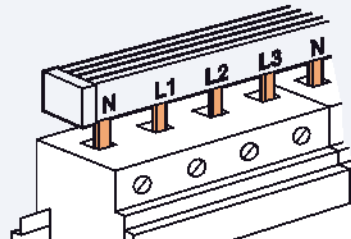

## Distribution terminal blocks



0 048 03



0 048 22



0 048 15

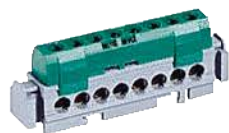

0 048 32

Pack	Cat. Nos	Distribution terminal blocks		
		Conform to standard IEC 60998-2-1 Supplied ready for use (screws not tightened) 100 A max. - 400 V~ with 25 mm <sup>2</sup> input 80 A max. - 400 V~ with 16 mm <sup>2</sup> input		
		<b>Screw terminal blocks</b> Fit with Ø M4 screws		
		Number of connections (mm <sup>2</sup> )	Length (mm)	
10	0 048 01	1 x 6 to 25 + 4 x 1.5 to 16	45	
10	0 048 03	1 x 6 to 25 + 8 x 1.5 to 16	73	
10	0 048 05	1 x 6 to 25 + 14 x 1.5 to 16	122	
10	0 048 06	1 x 6 to 25 + 19 x 1.5 to 16	157	
10	0 048 07	1 x 6 to 25 + 25 x 1.5 to 16	192	
		<b>Terminal blocks on support</b> Mounting on  or  rail with universal support Cat.No 0 048 11, or on 12 x 2 flat bar Supplied with Duplix markers		
10	0 048 20 <sup>1</sup>	4 x 1.5 to 16	47	
10	0 048 22 <sup>1</sup>	8 x 1.5 to 16	75	
10	0 048 24 <sup>1</sup>	1 x 6 to 25 + 12 x 1.5 to 16	113	
10	0 048 25 <sup>1</sup>	1 x 6 to 25 + 16 x 1.5 to 16	141	
10	0 048 26 <sup>1</sup>	1 x 6 to 25 + 21 x 1.5 to 16	176	
10	0 048 28 <sup>1</sup>	1 x 6 to 25 + 33 x 1.5 to 16	276	
		<b>IP 2X terminal blocks</b> Mounting on  or  rail with universal support Cat.No 0 048 11, or on 12 x 2 flat bar		
10	Phase (black) 0 048 16	Neutral (blue) 0 048 15	1 x 10 to 35 + 5 x 6 to 25	62
10	0 048 50	0 048 40	4 x 1.5 to 16	47
10	0 048 52	0 048 42	8 x 1.5 to 16	75
10	0 048 54	0 048 44	1 x 6 to 25 + 12 x 1.5 to 16	113
10		0 048 45	1 x 6 to 25 + 16 x 1.5 to 16	141
10		0 048 46	1 x 6 to 25 + 21 x 1.5 to 16	176
10		0 048 48	2 x 6 to 25 + 33 x 1.5 to 16	276
		<b>Earth (green)</b>		
10	0 048 30		4 x 1.5 to 16	47
10	0 048 32		8 x 1.5 to 16	75
10	0 048 34		1 x 6 to 25 + 12 x 1.5 to 16	113
10	0 048 35		1 x 6 to 25 + 16 x 1.5 to 16	141
10	0 048 36		1 x 6 to 25 + 21 x 1.5 to 16	176
10	0 048 38		2 x 6 to 25 + 33 x 1.5 to 16	276
		<b>Supports for terminal blocks</b>		
1	0 048 10	Distribution block support for connecting up to 4 IP 2X terminal block of the same size to create a distribution block		
5	0 048 11	Universal support for mounting an terminal blocks on  or  rail		
5	0 048 17	35-holes empty support, for screw terminal blocks Length: 276 mm		
		<b>Flat bar 12 x 2</b>		
10	0 048 19	Length: 1 meter		

1: Each terminal block is supplied with:  
- 2 green Duplix marked +  
- 2 blue Duplix marked N  
- 2 red Duplix marked L

## Distribution terminal blocks

### Mounting of terminal blocks on support

#### On 12 x 2 flat bar



#### On support for terminal blocks Cat.No 0 048 17

Enables you to make exactly the right number of connections

• Example:



#### Universal support Cat.No 0 048 11

Mounted on or rail, takes all terminal blocks

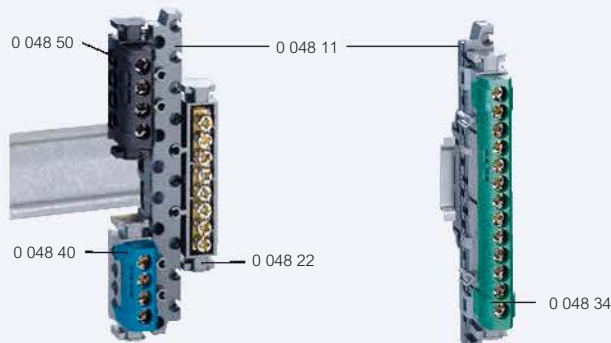

#### On distribution block support Cat.No 0 048 10

Possibility of forming a 2P, 3P or 4P distribution block by associating IP 2X terminal blocks

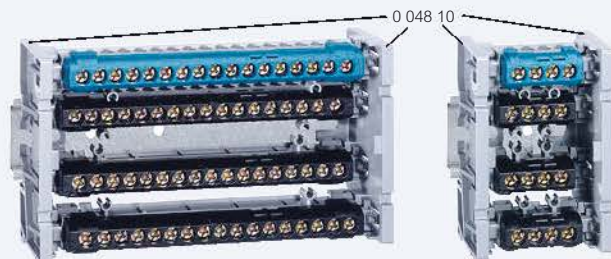

## Modular distribution blocks 40 to 250 A

## Modular distribution blocks 40 to 250 A



Dimensions [see e-catalogue](#)

Standard distribution  
Connection with or without Starfix ferrules (p. 292)  
Self-extinguishing, according to EN 60695-2-11: 960 °C on active part supports

Pack	Cat. Nos	Monobloc modular distribution blocks			
		Mounting on rail  or on plate with 2 screws Supplied with insulated back plate and transparent protective front cover Each bar can be labelled using CAB 3 Possible to add IP 2X terminal block (except Cat.No 0 048 77)			
		<b>Double pole</b> Equipped with 2 bars			
		Rating (A)	Isc peak (kA)	Icw (kA)	Number of modules
5	0 048 81	40	20	3	6
10	0 048 80	100	20	4.5	4
5	0 048 82	125	18	4.5	8
		<b>Four pole</b> Equipped with 4 bars			
5	0 048 85	40	20	3	6
10	0 048 84	100	20	4.5	4
5	0 048 86	125	20	4.5	6
5	0 048 88 <sup>1</sup>	125	14.5	4.2	8
1	0 048 76 <sup>2</sup>	125	20	4.5	10
1	0 048 79 <sup>1</sup>	160	27	8.4	10
1	0 048 77	250	42	14.4	9

**Modular distribution blocks**  
Mounting on rail   
Fitted with Lexic label holder  
Can be joined together  
Possibility of forming a four pole distribution block by adding modules

Single pole				
		Rating (A)	Isc peak (kA)	Number of modules
4	0 048 71	125	35	2
4	0 048 83	160	27	2
4	0 048 73	250	60	2

**Distribution terminals**

1	0 048 67	160 A - 6 outputs 25 mm <sup>2</sup> flexible - Isc peak 30 kA Can be fitted directly onto downstream terminal of Vistop 100/160 A
1	0 048 68	250 A - 4 outputs 35 mm <sup>2</sup> flexible and 2 outputs 25 mm <sup>2</sup> flexible - Isc peak 36 kA Can be fitted directly onto downstream terminal of DPX-IS 250

1: With short ferrule supplied for flexible connection 25 mm<sup>2</sup>  
2: Incoming conductors must be equipped with ferrules (p. 292)  
Connection: 25 mm<sup>2</sup> with ferrules without insulating flange

### Standards

Conform to EN 60947-1  
Insulating voltage according to EN 60947-1/IEC 60664-1: 500 V  
Impulse voltage (Uimp): 8 kV - Degree of pollution: 3

### Section for connecting rigid or flexible conductors (with Starfix ferrules)

Distribution Blocks Cat.Nos	Connections per bar		Rigid conductors Section (mm <sup>2</sup> )	Flexible conductors with ferrules	
	Number	Ø (mm)		Section (mm <sup>2</sup> )	Starfix ferrules Cat.Nos
0 048 67	6	8.5		6 to 25	0 376 68 to 71
0 048 68	4	10		6 to 35	0 376 68 to 77
	2	8.9		6 to 25	0 376 68 to 71
0 048 71	12	5.3	1.5 to 10	1.5 to 10	0 376 64 to 69
	4	10	16 to 50	16 to 35	0 376 70 to 77
0 048 73	4	6	2.5 to 16	2.5 to 10	0 376 66 to 69
	6	8.5	10 to 35	10 to 25	0 376 69 to 72
	1	-	70 to 150	70 to 120	-
0 048 80	5	5.3	2.5 to 10	1.5 to 10	0 376 64 to 69
	2	7.5	10 to 25	6 to 16	0 376 68 to 70/72
0 048 81	11	4.3	1.5 to 4	0.75 to 4	0 376 62 to 67
	2	6	6 to 16	4 to 10	0 376 67/68/69
0 048 82	11	5.3	2.5 to 10	1.5 to 10	0 376 64 to 69
	2	7.5	10 to 25	6 to 16	0 376 68 to 70/72
	2	9	10 to 35	10 to 25	0 376 69/72/71
0 048 83	7	5.3	2.5 to 10	1.5 to 6	0 376 64 to 69
	2	7.5	6 to 25	6 to 16	0 376 68/69/72
	3	8.9	10 to 35	10 to 25	0 376 69/72
	1	-	35 to 70	25 to 50	0 376 71 to 77/78
0 048 84	5	5.3	2.5 to 10	1.5 to 10	0 376 64 to 69
	2	7.5	10 to 25	6 to 16	0 376 68 to 70/72
0 048 85	11	4.3	1.5 to 4	0.75 to 4	0 376 62 to 67
	2	6	6 to 16	4 to 10	0 376 67/68/69
0 048 86	7	5.3	2.5 to 10	1.5 to 10	0 376 64 to 69
	2	7.5	10 to 25	6 to 16	0 376 68 to 70/72
	2	9	10 to 35	10 to 25	0 376 69/72
0 048 88	11	5.3	2.5 to 10	1.5 to 10	0 376 64 to 69
	4	8.5	10 to 35	6 to 25	0 376 68 to 71
0 048 79	1	-	35 to 70	35 to 70	0 376 77/78
	8	5.3	2.5 to 10	1.5 to 10	0 376 64 to 69
	4	7.5	10 to 25	6 to 16	0 376 68 to 70/72
	2	8.5	10 to 35	10 to 25	0 376 69/72
0 048 76	14	5.3	2.5 to 10	1.5 to 10	0 376 64 to 69
	1	7.5	10 to 25	6 to 16	0 376 68 to 70/72
	1	8.5	10 to 35	6 to 25	0 376 68 to 70/72
	1	-	-	16 to 35	0 376 70 to 77
0 048 77	6	6	2.5 to 16	2.5 to 10	0 376 66 to 69
	2	7.5	10 to 25	6 to 16	0 376 68 to 70/72
	2	8.5	10 to 35	10 to 25	0 376 69 to 72
	1	10	16 to 50	16 to 35	0 376 70 to 72/77
	1	-	50 to 120	50 to 120	0 376 78

### Characteristics of distribution blocks for use in photovoltaic installations

No of 18 mm modules	Cat.No	Max. cross-section for "solar cable"	Max. I <sub>e</sub> (A) current T = (+40°C/+60°C) IEC 60364-1	U <sub>i</sub> (V) Degree of pollution 2 IEC 60664-1	Impulse voltage U <sub>imp</sub> IEC 60664-1
<b>Single pole distribution block</b>					
2	0 048 71	4 x 16 to 25 mm <sup>2</sup> 12 x 1.5 to 6 mm <sup>2</sup> or 6 x 10 mm <sup>2</sup>	125/100	1000 V <sup>(1)</sup>	8 kV <sup>(2)</sup>
<b>Double pole distribution blocks</b>					
4	0 048 80	5 x 1.5 to 6 mm <sup>2</sup> 2 x 6 to 16 mm <sup>2</sup>	100/80	800 V <sup>(1)</sup>	8 kV <sup>(2)</sup>
8	0 048 82	11 x 1.5 to 6 mm <sup>2</sup> 2 x 6 to 16 mm <sup>2</sup> 2 x 10 to 25 mm <sup>2</sup>	125/100	800 V <sup>(1)</sup>	8 kV <sup>(2)</sup>

1: Supplementary insulation provided for the support rail in the context of application of UTE C 15712 double insulation  
2: Impulse voltage tested at 12 kV in the context of application of UTE C 15712 double insulation

Optimised and increased safety distribution systems, [see Product Guide](#)



For detailed dimensions, [see e-catalogue](#)



## Power distribution blocks

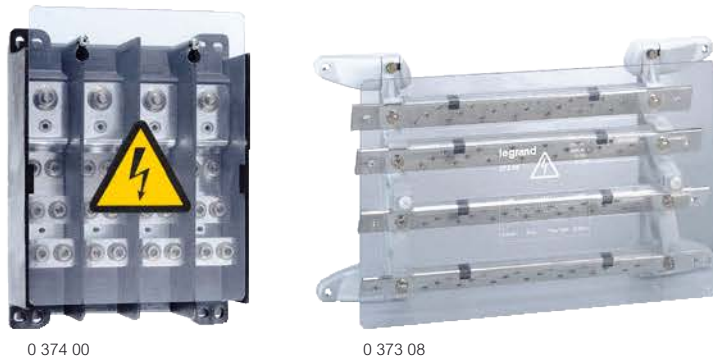

"Standard" distribution  
Supplied with screen protection

Pack	Cat. Nos	Extra-flat for lugs
1	0 374 47	<b>125 A</b> Fixing on rail EN 60715  or on plate with M6 screws. Equipped with: - 1 incoming 35 mm <sup>2</sup> (possible tapp-off) - 10 phase outgoing 16 mm <sup>2</sup> - M5 screws - 17 neutral outgoing 16 mm <sup>2</sup> - M5 screws Connection possible using connector Cat.No 0 373 65 (p. 209)
1	0 374 00	<b>250 A</b> Fixing on plain plate or on plate with M6 screws Distribution block 1 incoming 150 mm <sup>2</sup> per pole: - 1 pole is composed of 3 parts - Each part can receive: 1 x 70 mm <sup>2</sup> or 1 x 50 mm <sup>2</sup> and 1 x 35 mm <sup>2</sup> , or 2 x 35 mm <sup>2</sup> or 1 connector with 3 outgoing terminals Cat.No 0 374 03 (p. 183)
<b>Stepped for lugs</b>		
1	0 373 95	<b>125 A</b> Fixing on rail EN 60715  depth 15 mm or on plate with screws Ø 4 mm (by removing claws) 4 bars 12 x 4 mm with five connectors 2 x 10 mm <sup>2</sup> /bar (not mounted)
1	0 374 30	Fixing on rail EN 60715 , with claws Cat.No 0 374 39 (p. 261) or on plate with M6 screws 4 bars 15 x 4 mm supplied with: - 1 incoming 35 mm <sup>2</sup> - M8 screws - 5 outgoing 25 mm <sup>2</sup> - M6 screws
1	0 374 31	<b>160 A</b> Fixing on rail EN 60715 , with claws Cat.No 0 374 39 (p. 261) or on plate with M6 screws 4 bars 18 x 4 mm supplied with: - 1 incoming 70 mm <sup>2</sup> max. - M8 screws - 5 outgoing 35 mm <sup>2</sup> - M6 screws
1	0 374 35	<b>250 A</b> Fixing on rail EN 60715 , with claws Cat.No 0 374 39 (p. 261) or on plate with M6 screws 4 bars 25 x 4 mm supplied with: - 1 incoming 120 mm <sup>2</sup> - M10 screws - 5 outgoing 50 mm <sup>2</sup> - M8 screws
1	0 373 08	<b>400 A</b> Horizontal mounting in XL <sup>3</sup> 400 cabinets, vertical in XL <sup>3</sup> 400 cable sleeve, vertical in XL <sup>3</sup> 800 internal cable sleeve or on solid plate using the M6 screws supplied Distribution block consisting of 4 tin-coated bars 32 x 5 mm with insulated protection Composition of each bar: - 2 x Ø 8.5 mm untapped holes for power supply (flexible bars, ...) - 21 outgoing M6 holes (70 mm <sup>2</sup> lugs max.)
1	0 374 42	Fixing on rail EN 60715 , with claws Cat.No 0 374 39 (p. 261) Distribution block consisting of 4 bars 32 x 5 mm Composition of each bar: - 2 x Ø 10.5 mm untapped holes for power supply (185 mm <sup>2</sup> max.) - 15 outgoing M6 holes, 4 outgoing M8 holes

## Power distribution blocks

### Extra-flat for lugs

Self extinguishing: 960 °C according to EN 60695-2-11

**125 A** Cat.No 0 374 47 - Isc peak 25 kÅ

Insulating voltage according to EN 60947-1 / IEC 60664-1: 500 V

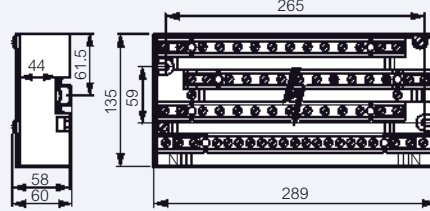

**250 A** Cat.No 0 374 00 - Isc peak 60 kÅ

Insulating voltage according to EN 60947-1 / IEC 60664-1: 1000 V

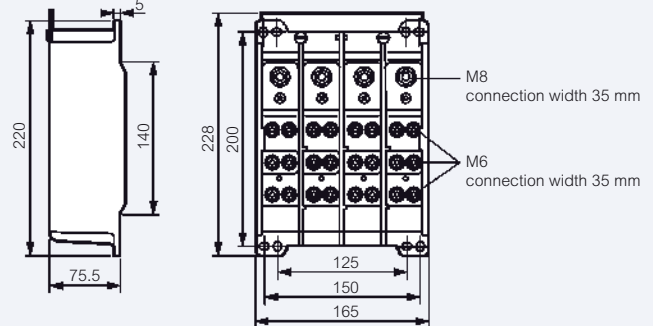

### Stepped for lugs

**125 A** Cat.No 0 373 95 - Isc peak 20 kÅ

Insulating voltage according to EN 60947-1 / IEC 60664-1: 600 V

Self extinguishing: 850 °C according to EN 60695-2-11

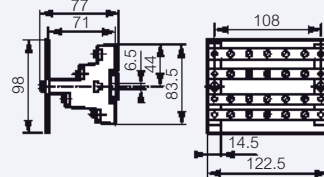

**125/160/250 A** Cat.Nos 0 374 30/31/35 - Isc peak 35 kÅ

Insulating voltage according to EN 60947-1 / IEC 60664-1: 1000 V

Self extinguishing: 850 °C according to EN 60695-2-11

Uimp: 12 kV, degree of pollution: 3

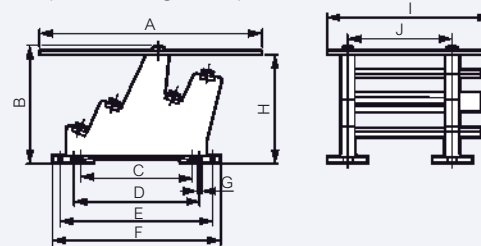

Dimensions (mm)

Distribution blocks	A	B	C	D	E	F	G	H	I	J
<b>125 A</b>	225	125	110	125	165	189	6.5	117.5	165	108
<b>160 A</b>	240	125	110	125	165	189	6.5	117.5	180	120
<b>250 A</b>	260	155	110	125	185	209	6.5	147.5	195	120

**400 A<sup>(1)</sup> Cat.No 0 373 08** - Isc peak 42 kÅ. Insulating voltage according to EN 60947-1 / IEC 60664-1: 1000 V. Uimp: 12 kV, degree of pollution: 3  
Self extinguishing: 960 °C according to EN 60695-2-11

**Cat.No 0 374 42** - Isc peak 50/75 kÅ. Insulating voltage according to EN 60947-1 / IEC 60664-1: 1000 V fixing centres 50 mm, 1500 V fixing centres 75 mm. Uimp: 8 kV fixing centres 50 mm, 12 kV fixing centres 75 mm. Degree of pollution: 3

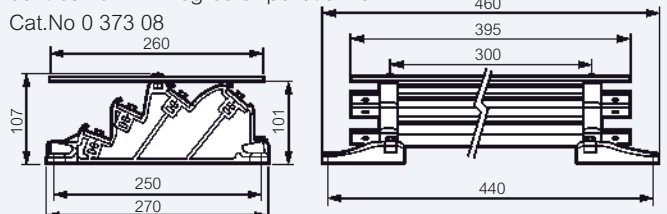



## Connection



0 374 05 on copper bar 0 374 00

0 330 74

"Standard" distribution

Pack	Cat. Nos	Connectors															
10	0 374 03	<b>With 3 outgoing terminals 200 A</b> Fits onto flat copper bars and distribution block Cat.No 0 374 00 (p. 182) Capacity: - 1 x Ø 5.3 mm outgoing terminal for 1.5 to 6 mm <sup>2</sup> connection - 2 x Ø 7.5 mm outgoing terminals for 6 to 16 mm <sup>2</sup> connection															
4	0 373 99	<b>With 6 outgoing terminals 250 A</b> Fits onto C section aluminium bars with M10 hammer head bolt Cat.No 0 373 59 or onto flat copper bars Capacity: - 4 x 6 to 35 mm <sup>2</sup> - 2 x 6 to 25 mm <sup>2</sup>															
5	0 374 05	<b>With 7 outgoing terminals 400 A</b> Fits onto flat copper bars Capacity: - 4 x Ø 5.3 mm outgoing terminals for 1.5 to 6 mm <sup>2</sup> connection - 3 x Ø 7.5 mm outgoing terminals for 6 to 16 mm <sup>2</sup> connection															
		<b>Aluminium/copper distribution boxes up to 300 mm<sup>2</sup></b> Adapt the cross-section of the incoming or outgoing cable in order to connect a device IP 2X box, self-extinguishing transparent cover Universal fixing on rail or on plate Reversible sealable cover with area for label Operational voltage: U <sub>e</sub> = 690 V~ according to EN 60947-1/IEC 60664-1 • Aluminium connection Conform to standard NFC 63-061 class B • Copper connection Conform to standard EN 60947-7-1 Supplied with copper coupling strip															
5	0 374 80	Aluminium/copper 120 mm <sup>2</sup> distribution box 300 A max. Incoming: 16 to 120 mm <sup>2</sup> Aluminium or 16 to 120 mm <sup>2</sup> copper Outgoing: 16 to 70 mm <sup>2</sup> copper															
4	0 374 81	Aluminium/copper 300 mm <sup>2</sup> distribution box 540 A max. Incoming: 70 to 300 mm <sup>2</sup> Aluminium or 70 to 185 mm <sup>2</sup> copper Outgoing: 70 to 150 mm <sup>2</sup> copper															
		<b>Junction boxes IP 30 - IK 07</b> For copper cables 4 connections per pole Reversible stirrup for zero clamping Fitted with 4 or 5 junction blocks mounted on an insulated strip with a sheet steel cover Knock-out entries for conduits Ø 9 and 21 mm Sealable cover screws RAL 7035															
1	0 330 44	<table border="1"> <thead> <tr> <th>Poles</th> <th>Cable section (mm<sup>2</sup>)</th> <th>Rated current (A)</th> </tr> </thead> <tbody> <tr> <td>4</td> <td>35</td> <td>125</td> </tr> <tr> <td>4</td> <td>70</td> <td>192</td> </tr> <tr> <td>4</td> <td>150</td> <td>309</td> </tr> <tr> <td>4</td> <td>240</td> <td>415</td> </tr> </tbody> </table>	Poles	Cable section (mm <sup>2</sup> )	Rated current (A)	4	35	125	4	70	192	4	150	309	4	240	415
Poles	Cable section (mm <sup>2</sup> )	Rated current (A)															
4	35	125															
4	70	192															
4	150	309															
4	240	415															

## Connection

### Connectors

Cat.No 0 374 03

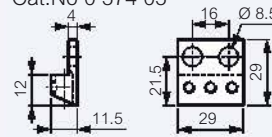

Cat.No 0 374 05

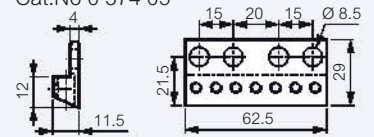

Cat.No 0 373 99

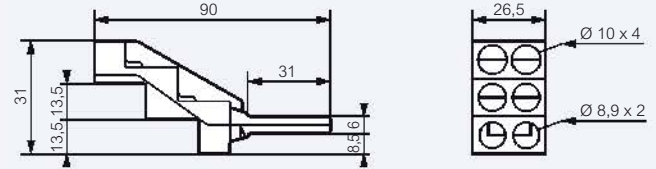

### Aluminium/copper distribution boxes

#### Technical characteristics

	Cat.No 0 374 80	Cat.No 0 374 81
Impulse voltage (U <sub>imp</sub> )	10 kV	12 kV
Short-circuit current I <sub>sc</sub> for 1 second	14.5 kA	22.2 kA
Tightening torque	14 Nm	30 Nm

#### Dimensions

Cat.No 0 374 80

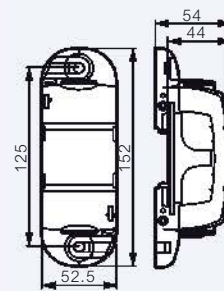

Cat.No 0 374 81

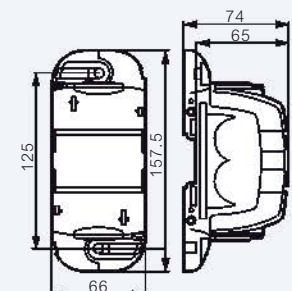

#### Connection

##### Junction

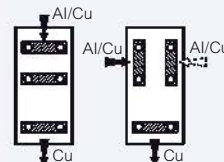

##### Distribution

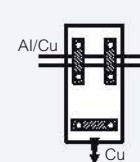

#### Connecting in series

This bridging is made with 2 copper bars (supplied with each product) and accept max. rating of incoming cable for tap-off between 2 distributions boards

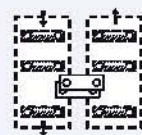



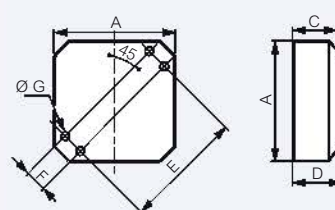



### Junction boxes



Cat.Nos	A (mm)	C (mm)	D (mm)	E (mm)	F (mm)	G (mm)
0 330 44	236	75	89	264	40	6
0 330 54	276	84	99	314	40	7
0 330 74	319	103	118	361	50	7
0 330 84	510	129	144	613	65	9

# Flat copper bars selection

standard distribution

			≤ 400 A				≤ 800 A		≤ 1000 A		≤ 1600 A			
Flat busbars supports														
			Cat.No 0 373 10		Cat.No 0 373 15		Cat.No 0 373 20		Cat.No 0 373 21		Cat.Nos 0 373 22/23			
											Bar mounting: edgewise		Bar mounting: flat	
Flat copper bars														
Cat.Nos	Cross section (mm)	Number of bar per pole	I (A)		I (A)		I (A)		I (A)		I (A)		I (A)	
			IP ≤ 30	IP > 30	IP ≤ 30	IP > 30	IP ≤ 30	IP > 30	IP ≤ 30	IP > 30	IP ≤ 30	IP > 30	IP ≤ 30	IP > 30
0 374 34	18 x 4	1	245	200	245	200	245	200	-	-	-	-	-	-
0 374 38	25 x 4	1	280	250	-	-	-	-	-	-	-	-	-	-
0 374 18	25 x 5	1	330	270	330	270	330	270	-	-	-	-	-	-
0 374 19	32 x 5	1	450	400	450	400	450	400	-	-	-	-	-	-
0 374 40	50 x 5	1	-	-	-	-	700	630	700	630	700	630	430	350
		2	-	-	-	-	-	-	-	-	1150	1000	650	510
		3	-	-	-	-	-	-	-	-	-	-	-	-
		4	-	-	-	-	-	-	-	-	-	-	-	-
0 374 41	63 x 5	1	-	-	-	-	800	700	800	700	800	700	500	400
		2	-	-	-	-	-	-	-	-	1350	1150	770	590
		3	-	-	-	-	-	-	-	-	-	-	-	-
		4	-	-	-	-	-	-	-	-	-	-	-	-
0 374 59	75 x 5	1	-	-	-	-	-	-	950	850	950	850	600	475
		2	-	-	-	-	-	-	-	-	1500	1300	890	700
		3	-	-	-	-	-	-	-	-	-	-	-	-
		4	-	-	-	-	-	-	-	-	-	-	-	-
0 374 43	80 x 5	1	-	-	-	-	-	-	1050	900	1000	900	630	500
		2	-	-	-	-	-	-	-	-	1650	1450	940	740
		3	-	-	-	-	-	-	-	-	-	-	-	-
		4	-	-	-	-	-	-	-	-	-	-	-	-
0 374 46	100 x 5	1	-	-	-	-	-	-	-	-	1250	1050	750	580
		2	-	-	-	-	-	-	-	-	1900	1600	1120	900
		3	-	-	-	-	-	-	-	-	-	-	-	-
		4	-	-	-	-	-	-	-	-	-	-	-	-
	125 x 5	1	-	-	-	-	-	-	-	-	-	-	-	-
		2	-	-	-	-	-	-	-	-	-	-	-	-
		3	-	-	-	-	-	-	-	-	-	-	-	-
		4	-	-	-	-	-	-	-	-	-	-	-	-
	80 x 10	1	-	-	-	-	-	-	-	-	-	-	-	-
		2	-	-	-	-	-	-	-	-	-	-	-	-
		3	-	-	-	-	-	-	-	-	-	-	-	-
	100 x 10	1	-	-	-	-	-	-	-	-	-	-	-	-
		2	-	-	-	-	-	-	-	-	-	-	-	-
		3	-	-	-	-	-	-	-	-	-	-	-	-
	120 x 10	1	-	-	-	-	-	-	-	-	-	-	-	-
		2	-	-	-	-	-	-	-	-	-	-	-	-
3		-	-	-	-	-	-	-	-	-	-	-	-	
200 x 10	1	-	-	-	-	-	-	-	-	-	-	-	-	
	2	-	-	-	-	-	-	-	-	-	-	-	-	
	3	-	-	-	-	-	-	-	-	-	-	-	-	

## Copper bars and accessories

≤ 4000 A				≤ 6300 A			
 Cat.Nos 0 373 24/25 Bar mounting: edgewise		 Bar mounting: flat		 Cat.Nos 0 373 12/13 Bar mounting: edgewise		 Bar mounting: flat	
I (A)		I (A)		I (A)		I (A)	
IP ≤ 30	IP > 30	IP ≤ 30	IP > 30	IP ≤ 30	IP > 30	IP ≤ 30	IP > 30
-	-	-	-	-	-	-	-
-	-	-	-	-	-	-	-
-	-	-	-	-	-	-	-
-	-	-	-	-	-	-	-
700	630	500	420	-	-	-	-
1180	1020	750	630	-	-	-	-
1600	1380	1000	900	-	-	-	-
2020	1720	1120	1000	-	-	-	-
800	700	600	500	-	-	-	-
1380	1180	750	630	-	-	-	-
1900	1600	1100	1000	-	-	-	-
2350	1950	1350	1200	-	-	-	-
950	850	700	600	-	-	-	-
1600	1400	1000	850	-	-	-	-
2200	1900	1250	1100	-	-	-	-
2700	2300	1600	1400	-	-	-	-
1000	900	750	630	-	-	-	-
1700	1480	1050	900	-	-	-	-
2350	2000	1300	1150	-	-	-	-
2850	2400	1650	1450	-	-	-	-
1250	1050	850	700	-	-	-	-
2050	1800	1200	1050	-	-	-	-
2900	2450	1600	1400	-	-	-	-
3500	2900	1900	1650	-	-	-	-
1450	1270	1000	800	-	-	-	-
2500	2150	1450	1250	-	-	-	-
3450	2900	1800	1600	-	-	-	-
4150	3450	2150	1950	-	-	-	-
1460	1270	1150	950	-	-	-	-
2500	2150	1700	1500	-	-	-	-
3450	2900	2500	2000	-	-	-	-
1750	1500	1350	1150	-	-	-	-
3050	2550	2000	1650	-	-	-	-
4150	3500	2900	2400	-	-	-	-
2000	1750	1650	1450	-	-	-	-
3600	2950	2500	2000	-	-	-	-
4800	4000	3500	3000	-	-	-	-
-	-	-	-	3300	3000	2750	2400
-	-	-	-	5200	4800	3600	3250
-	-	-	-	7000	6400	5400	4800



0 374 19 + 0 373 11



0 374 40



0 374 10

"Standard" distribution



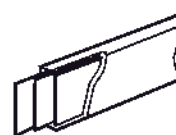
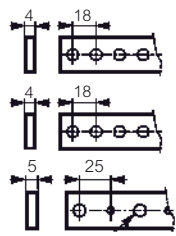









Pack	Cat.Nos	Copper bars				
<b>Rigid, flat, threaded holes</b>						
		Cross section (mm)	I permissible (A)		Holes Ø mm	Length (mm)
			IP ≤ 30	IP > 30		
10	0 373 88	12 x 2	110	80	M5	990
10	0 373 89	12 x 4	160	125	M5	990
10	0 374 33	15 x 4	200	160	M6	990
10	0 374 34	18 x 4	245	200	M6	990
10	0 374 38	25 x 4	280	250	M6	990
4	0 374 18	25 x 5	330	270	M6	1750
4	0 374 19	32 x 5	450	400	M6	1750
<b>Rigid flat clear holes</b>						
		Cross section (mm)				Length (mm)
1	0 374 40	50 x 5	700	630	10.5 - 6.5	1750
1	0 374 41	63 x 5	800	700	10.5 - 8.5	1750
1	0 374 59	75 x 5	950	850	10.5 - 6.5	1750
1	0 374 43	80 x 5	1000	900	10.5 - 6.5	1750
1	0 374 46	100 x 5	1250	1050	10.5 - 6.5	1750
<b>Flexible</b>						
Supplied flat, length 2 m						
		Cross section (mm)	IP ≤ 30	IP > 30		
1	0 374 10	13 x 3	200	160		
1	0 374 67	20 x 5	400	250		
1	0 374 11	24 x 4	400	250		
1	0 374 12	32 x 5	630	400		
1	0 374 57	50 x 5	850	630		
1	0 374 58	50 x 10	1250	1000		



<b>Accessories</b>	
10	0 373 11 Isolating profile for flat copper bars 18 x 4, 25 x 4, 25 x 5 and 32 x 5 mm, length 1 m Supplied with fixing clips
50	0 367 74 Insulating screws M6 x 10
50	0 367 75 HF screws with contact washer M6 x 10

# Busbars supports selection

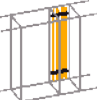
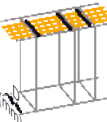
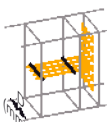
standard distribution

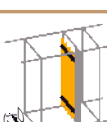
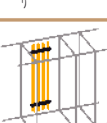
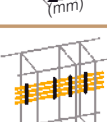
Max. In (A) Supports		Flat copper bars						
		400	800	1000	1600	4000	6300	
Mounting		 0 373 10	 0 373 15	 0 373 20	 0 373 21	 0 373 22/23	 0 373 24/25	 0 373 12/13
		<b>XL<sup>3</sup> 400</b>						
	Vertical at back of cabinet or enclosure		●					
	Vertical at back of cable sleeve	●						
<b>XL<sup>3</sup> 800</b>								
	Vertical at back of cabinet or enclosure		● + 0 373 14					
	Vertical at back of internal cable sleeve	●						
	Vertical at back of external cable sleeve			●				
<b>XL<sup>3</sup> 4000</b>								
	Main horizontal at top or at bottom of cabinet	D : 475				● + 0 205 51 <sup>(5)</sup>		
		D : 725				● + 0 205 52	● <sup>(5)</sup>	● <sup>(5)</sup>
		D : 975				● + 0 205 53	● <sup>(1)</sup>	● <sup>(1)</sup>
	Horizontal transfer	D : 725				● + 0 205 51	● <sup>(4+5)</sup>	● <sup>(4+5)</sup>
		D : 975				● + 0 205 52	●	●
	Vertical lateral inside cable sleeve	D : 475		● + 0 205 51	● + 0 205 51	● + 0 205 51		
		D : 725		● + 0 205 52	● + 0 205 52	● + 0 205 52	●	●
		D : 975		● + 0 205 53	● + 0 205 53	● + 0 205 53	● <sup>(1)</sup>	● <sup>(1)</sup>
	Vertical lateral inside cabinet behind upright	D : 725		● + 0 205 51		● + 0 205 51		
		D : 975		● + 0 205 52		● + 0 205 52	●	●
	Vertical at back of cabinet	W : 475		● + 0 205 51		● + 0 205 51 <sup>(2)</sup>		
		W : 725	● + 0 373 14	● + 0 205 52		● + 0 205 52		
		W : 975		● + 0 205 53		● + 0 205 53		
	Horizontal at back of cabinet	W : 475		● <sup>(3)</sup> + 0 205 51		● <sup>(3)</sup> + 0 205 51	● <sup>(3)</sup> + 0 205 51	● <sup>(3)</sup> + 0 205 51
		W : 725		● <sup>(3)</sup> + 0 205 52		● <sup>(3)</sup> + 0 205 52	● <sup>(3)</sup> + 0 205 52	● <sup>(3)</sup> + 0 205 52
		W : 975		● <sup>(3)</sup> + 0 205 53		● <sup>(3)</sup> + 0 205 53	● <sup>(3)</sup> + 0 205 53	● <sup>(3)</sup> + 0 205 53

1: With upright Cat.No 0 205 20 in cable sleeve - 2: Depth min. 725 mm - 3: Fixed supports only - 4: Inside complementary cable sleeve - 5: Partial chassis

# Isolating supports for busbars

## XL<sup>3</sup> cabinets and enclosures



0 373 10



0 373 24

Dimensions and distances between the supports **see e-catalogue**

"Standard" distribution

### Pack Cat. Nos 1 bar per pole universal supports

Pack	Cat. Nos	1 bar per pole universal supports	
10	0 373 98	≤ 280 A Single pole support for flat copper bars 12 x 2 or 14 x 4 mm	
10	0 374 37	Single pole support for flat copper bars 15 x 4, 18 x 4 or 25 x 4 mm	
5	0 373 96	Set of 2 four pole supports for flat copper bars 12 x 2 or 12 x 4 mm	
1	0 374 32	Set of 2 four pole supports for flat copper bars 15 x 4 or 18 x 4 mm	
1	0 374 36	Set of 2 four pole supports for flat copper bars 25 x 4 mm	
<b>1 bar per pole</b>			
1	0 373 15	≤ 400 A Support for flat copper bars 18 x 4, 25 x 5 and 32 x 5 mm	
1	0 373 10	For XL <sup>3</sup> 400 cabinets and enclosures Support for flat copper bars 18 x 4, 25 x 4, 25 x 5 and 32 x 5 mm, in sloping position to create a vertical busbars at back For direct mounting on solid or perforated plate	
1	0 373 20	≤ 800 A Support for flat copper bars 18 x 4, 25 x 5, 32 x 5, 50 x 5 and 63 x 5 mm in sloping position	
1	0 373 21	≤ 1000 A Support for flat copper bars 50 x 5, 63 x 5, 75 x 5 and 80 x 5 mm in staggered position	

### Pack Cat. Nos 1 or 2 bars per pole

Pack	Cat. Nos	1 or 2 bars per pole	
		Supports for flat copper bars 50 x 5, 63 x 5, 75 x 5, 80 x 5 and 100 x 5 mm, in aligned position ≤ 1600 A	
1	0 373 22	Fixed support	
1	0 373 23	Additional support Mounted in addition to fixed support Cat.No 0 373 22 to comply with the distances (Isc withstand)	
<b>1 to 4 bars per pole</b>			
		≤ 4000 A Supports for 4 flat bars from 50 x 5 to 125 x 5 mm or 3 bars from 50 x 10 to 120 x 10 mm, in aligned position	
1	0 373 24	Fixed support	
1	0 373 25	Additional support Mounted in addition to fixed support Cat.No 0 373 24 to comply with the distances (Isc withstand)	
		≤ 6300 A Reinforced 4P isolating supports Hold flat copper bars in position Up to three 200 x 10 mm bars per pole	
1	0 373 12	Fixed support	
1	0 373 13	Additional support Mounted in addition to fixed support Cat.No 0 373 12 to comply with the distances (Isc withstand)	
<b>Fixing supports</b>			
<b>Adjustable crosspieces</b>			
1	0 205 51	Set of 2 crosspieces length 350 mm	
1	0 205 52	Set of 2 crosspieces length 600 mm	
1	0 205 53	Set of 2 crosspieces length 850 mm	
<b>Crosspieces for partial chassis</b>			
1	0 205 31	Set of 2 fixed crosspieces length 350 mm	
1	0 205 32	Set of 2 fixed crosspieces length 600 mm	
<b>Extension piece</b>			
1	0 373 14	For mounting busbars supports Cat.No 0 373 15 in XL <sup>3</sup> 800 and 4000 cabinets and enclosures	

Optimised and increased safety  
distribution systems,  
**see Product Guide**



For the distances between isolating  
supports, **see e-catalogue**





# ENCLOSURES

## Ready to use cabinets & enclosures



**P. 190**  
Surface mounting terminal shiled boxes



**NEW**  
**P. 195**  
Nedbox flush-mounting cabinets

## Self-assembly cabinets & enclosures



**P. 204**  
XL³ 400 distribution cabinets & enclosure



**P. 227**  
XL³ 4000 equipment & accessories

## Weatherproof enclosures & accessories



**P. 240**  
Plexo³ IP 65 weatherproof cabinets



**P. 256**  
Equipment for Atlantic, Atlantic-F & Marina cabinets

## NEW PRODUCTS 2014



**XL³ 6300**  
distribution enclosures up to 6300 A  
(p. 234)



**P. 191**  
Practibox  
flush-mounting  
cabinets



**NEW**  
**P. 192**  
British standard  
surface mounting  
consumer units



**P. 193**  
British standard  
flush-mounting  
consumer units



**P. 194**  
Nedbox  
surface mounting  
cabinets



**P. 196**  
XL³ 125  
surface mounting  
distribution  
cabinets



**P. 197**  
XL³ 125/250  
surface &  
flush-mounting  
distribution boards



**P. 198**  
XL³ 160  
flush-mounting  
distribution  
cabinets



**P. 199**  
XL³ 160  
surface mounting  
distribution  
cabinets



**P. 206**  
XL³ 400  
equipment &  
accessories



**P. 212**  
XL³ 800  
distribution  
cabinets &  
enclosures



**P. 216**  
XL³ 800  
equipment &  
accessories



**P. 224**  
XL³ 4000  
distribution  
enclosures



**NEW**  
**P. 234**  
XL³ 6300  
distribution  
enclosures



**P. 244**  
Atlantic  
IP 55/IP 66  
metal cabinets



**P. 248**  
Atlantic - E  
IP 66 metal  
cabinets



**P. 250**  
Marina  
IP 66 polyester  
cabinets



**P. 252**  
Marina  
IP 66 polyester  
enclosures



**P. 262**  
Heat regulation  
for cabinets &  
enclosures



**P. 267**  
IP 55 plastic  
cable glands



**P. 268**  
IP 68 plastic  
cable glands



**P. 269**  
IP 68 metal  
cable glands

## Surface mounting terminal shield boxes 2 to 6 modules



IP 30  
 Conform to IEC 60439-3  
 Self extinguishing: 650° C  
 Supplied without terminal blocks  
 Class II  
 White RAL 9010  
 Covers can be sealed  
 Allows to achieve assemblies conform to IEC 61439-3

Pack	Cat.Nos	Terminal shield boxes	Capacity in 17.5 mm modules	Dimensions (mm) Height x Width x Thickness
50	0 013 56	2 modules	2 modules	140 x 52 x 68
30	0 013 57	4 modules	4 modules	140 x 87 x 68
20	0 013 58	6 modules	6 modules	140 x 130 x 68

## Surface mounting terminal shield boxes 2 to 6 modules

### Dimensions

#### 2 modules

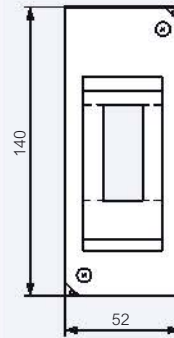

#### 4 modules

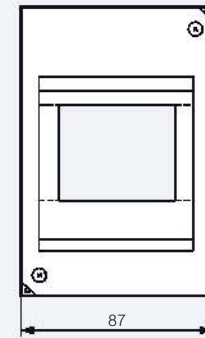

#### 6 modules

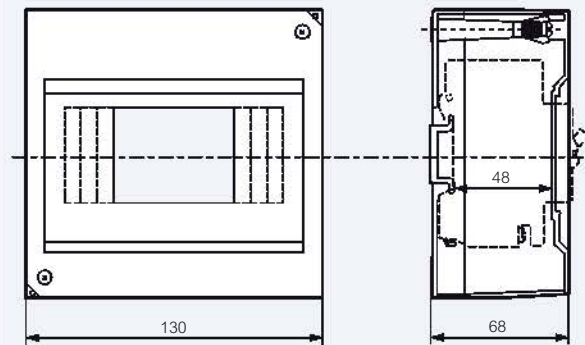

### Mounting

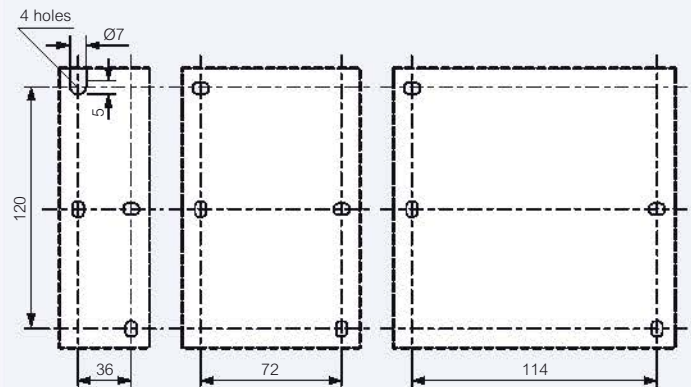



## Flush-mounting cabinets Practibox™ 6 to 36 modules



6 011 11

6 011 14

IP 40 - IK 07 with door  
Class II  
Conform to standard IEC 60439-3  
Allows to achieve assemblies conform to IEC 61439-3  
Reversible faceplate  
Box for masonry  
Self extinguishing 650 °C  
White RAL 9003  
Supplied without terminal block

Pack	Cat.Nos	Terminal shield boxes
1/12	6 011 10	1 row of 6 modules
1/12	6 011 11	1 row of 8 modules
1/6	6 011 12	1 row of 12 modules
1/5	6 011 13	2 rows of 12 modules
1/3	6 011 14	3 rows of 12 modules

		Accessories
		<b>Blanking plate</b> Separable into modules or 1/2 modules 5 modules - white
20	0 016 60	<b>Terminal blocks</b> Neutral and earth - 2 x 8 holes
10	6 012 90	<b>Key lock</b> Only for 2 and 3 rows distribution cabinets N° 850
1	0 019 66	

## Flush-mounting cabinets Practibox™ 6 to 36 modules

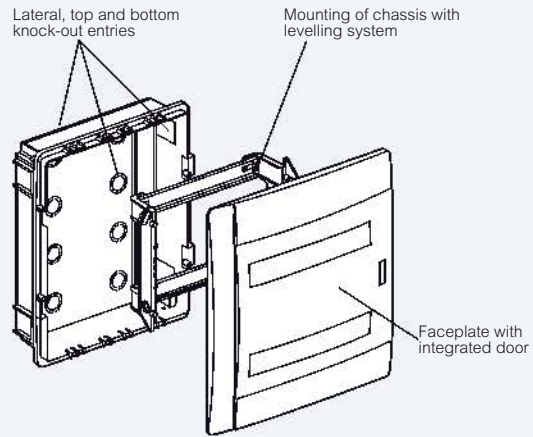

### Dimensions

#### Cabinets 6, 8 and 12 modules

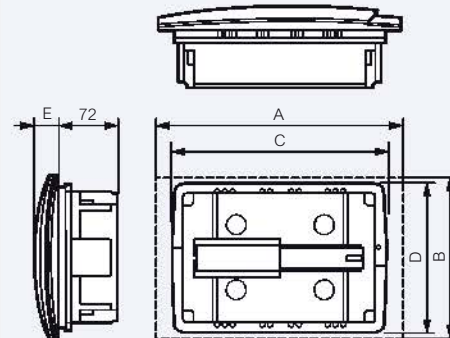

	Number of modules		
	6 mod.	8 mod.	12 mod.
A	230	266	334
B	186	188	225
C	208	244	287
D	180	180	208
E	27	27	31

#### Cabinets 24 and 36 modules

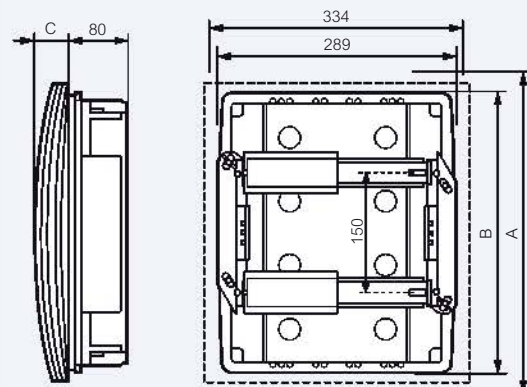

	Number of modules	
	24 mod.	36 mod.
A	376	526
B	358	508
C	40	42

## Surface mounting British standard consumer units



## Surface mounting British standard consumer units



6 075 68



6 075 61

Conform to EN 60439-3  
Allows to achieve assemblies conform to IEC 61439-3  
Supplied completely assembled with neutral and earth terminals

Pack	Cat.Nos	Surface mounting boxes
1	6 075 68	Plastic IP 30 – IK 07 with white hinged door White RAL 9003
		<b>4 to 8 module units</b>
		Comprising:
		• One neutral + one earth terminals
		• One supply busbar
		• Isolating shield
1	6 075 68	4 modules units
1	6 075 61	8 modules units (with five blanking plates)
		<b>12 to 22 module units</b>
		Removable pan assembly
		Comprising:
		• Two neutral + one earth terminals
		• Five blanking plates
		• One supply busbar
		• Isolating shield
1	6 075 62	12 modules units

### Plastic IP 30 - IK 07

#### 4 to 22 module units

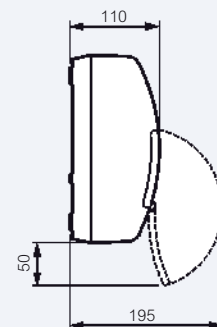
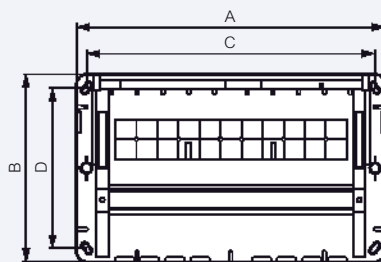

Cat.Nos	Dimensions			
	A	B	C	D
6 075 68	140	225	90	144
6 075 61	212	225	162	144
6 075 62	298	225	268	180

#### Removable pan assembly

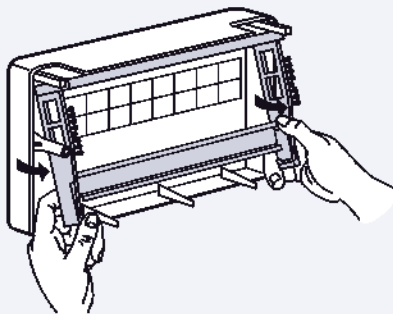

## Flush-mounting British standard consumer units



6 010 44

Conform to EN 60439-3  
Allows to achieve assemblies conform to IEC 61439-3  
Supplied completely assembled with neutral and earth terminals

Pack	Cat.Nos	Flush mounting boxes
1	6 010 42	Metal IP 41 - IK 08 with white metal door
1	6 010 44	8 modules units (6 available MCB ways)
1	6 010 44	12 modules units (10 available MCB ways)
1	6 010 46	16 modules units (14 available MCB ways)

## Flush-mounting British standard consumer units

### Metal IP 41 - IK 08

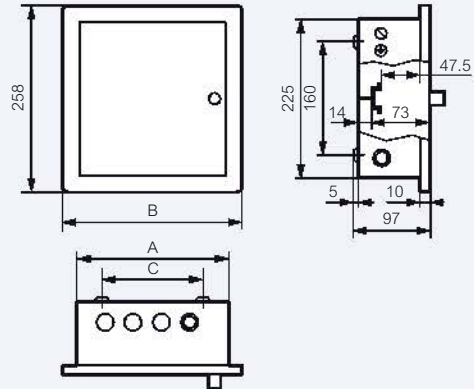

Cat.Nos	Dimensions			Top bottom			
	A	B	C	Ø25	Ø32	Ø25	Ø32
6 010 42	210	250	140	3	1	3	1
6 010 44	281	321	211	5	1	5	1
6 010 46	353	393	283	6	1	6	1

## Surface mounting cabinets Nedbox

8 to 48 modules



IP 40 - IK 07 with door  
 IP 30 - IK 05 without door  
 Class II - White RAL 9010  
 Conform to EN 60439-3  
 Allows to achieve assemblies conform to IEC 61439-3  
 Self extinguishing 650° C  
 Polystyrene material  
 Can be equipped with reversible plastic or metal door  
 Chassis can be clipped removed and tipped back to facilitate cabling  
 Supplied without terminal blocks (see below)

Pack	Cat.Nos	Distribution boxes
1	6 012 40	<b>Cover fixing with quick motion screws</b>
1	6 012 41	1 row of 8 modules 1 row of 12 + 1 modules
1	6 012 42	<b>Fast locking by flip latch</b>
1	6 012 43	Distance between rails : 125 mm
1	6 012 44	2 rows of 12 + 2 modules 3 rows of 12 + 3 modules 4 rows of 12 + 4 modules

		Doors		
		Plastic doors - polycarbonate		
		White	Transparent blue tinted	
1	6 012 05	6 012 15		For Cat.No 6 012 40
1	6 012 06	6 012 16		For Cat.No 6 012 41
1	6 012 07	6 012 17		For Cat.No 6 012 42
1	6 012 08	6 012 18		For Cat.No 6 012 43
1	6 012 09	6 012 19		For Cat.No 6 012 44
		White		<b>Metal doors</b>
1	6 012 26			For Cat.No 6 012 41
1	6 012 27			For Cat.No 6 012 42
1	6 012 28			For Cat.No 6 012 43
1	6 012 29			For Cat.No 6 012 44

		Accessories		
1	0 014 91	Key lock for Cat.Nos 6 012 42/43/44 and 6 014 41/42/43/44/51/52/53/54		
1	0 013 89	Sealing kit		
		<b>Blanking plates</b>		
20	0 016 60	Separable into modules or 1/2 modules		
10	0 016 62	5 modules - white 13 modules - white		
10	6 012 90	<b>Terminal blocks for 1 row of 8 modules</b>		
		Neutral and earth - 2 x 8 holes		
		<b>Terminal blocks for 1, 2, 3 and 4 rows of 12 modules</b>		
10	6 012 91	Neutral and earth - 2 x 12 holes		
10	6 012 92	Earth - 30 holes		
10	6 012 93	Neutral - 30 holes		

## Surface mounting cabinets Nedbox

8 to 48 modules

### Distribution cabinets 2, 3 or 4 rows of 12 modules

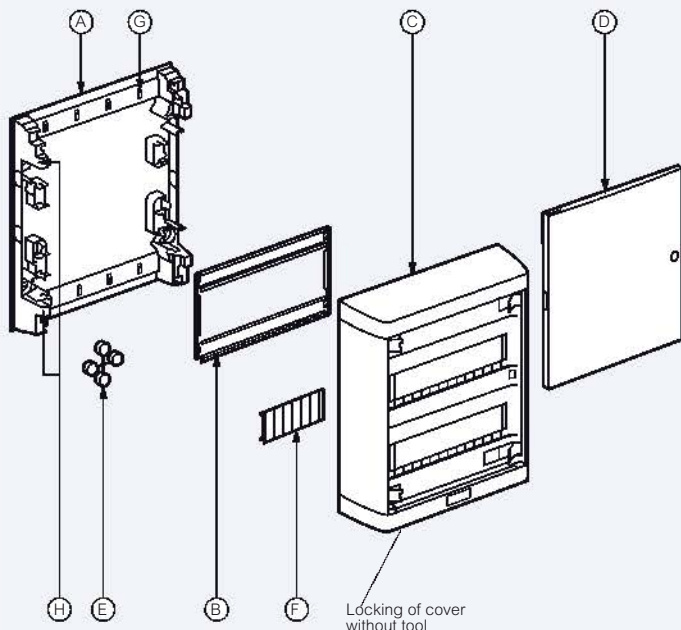

- A : insulating base
- B : chassis/rail
- C : cover
- D : plastic or metal door
- E : sealing caps
- F : blanking plates
- G : supports for cables ties
- H : fixation for terminal blocks

### Pre-cut part for trunking systems

For 2, 3 and 4 rows cabinets

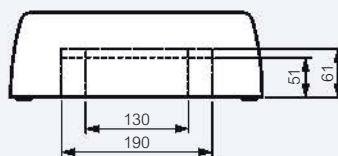

For 1 row cabinets

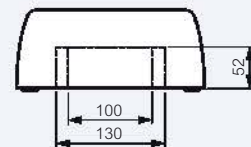

### Dimensions

Space under rail

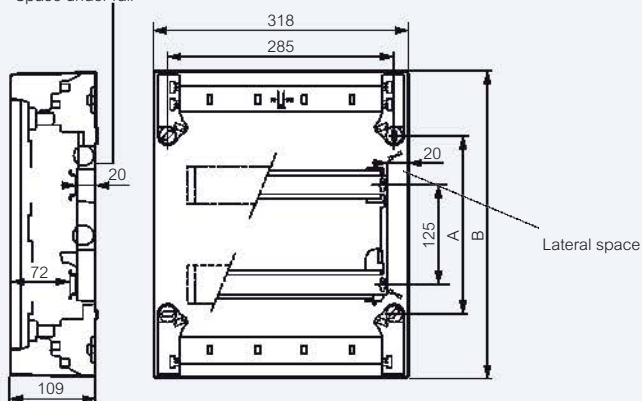

	24 mod.	36 mod.	48 mod.
A	225	350	475
B	380	505	630

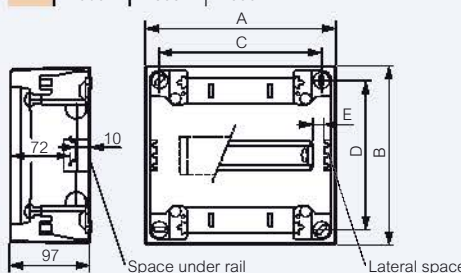

	8 mod.	12 mod.
A	225	317
B	210	240
C	195	287
D	180	150
E	14	9

## Flush-mounting cabinets Nedbox

12 to 48 modules



0 014 43

0 014 53

IP 40 - IK 07  
Class II  
Conform to EN 60439-3  
Allows to achieve assemblies conform to IEC 61439-3  
Self extinguishing: resistance to incandescent wire 850° C

### Pack Cat.Nos Flush-mounting distribution cabinets

		White RAL 9010				
		Supplied with:				
		- reversible door				
		- screw terminal blocks for neutral and earth				
		Spacing between rails 125 mm				
		For installation in dry partitions use the flush-mounting kit Cat.No 0 014 90				
		<b>With metal door white RAL 9010</b>				
		Number of rows	Number of modules	Height (mm)	Width (mm)	Depth (mm)
1	0 014 41	1	12 + 2	305	330	87
1	0 014 42	2	24 + 4	430	330	87
1	0 014 43	3	36 + 6	555	330	87
1	0 014 44	4	48 + 8	680	330	87
		<b>With transparent door</b>				
		Number of rows	Number of modules	Height (mm)	Width (mm)	Depth (mm)
1	0 014 51	1	12 + 2	305	330	87
1	0 014 52	2	24 + 4	430	330	87
1	0 014 53	3	36 + 6	555	330	87
1	0 014 54	4	48 + 8	680	330	87

### Accessories

#### "Reduced depth" mounting frame for dry partitions

For reducing the mounting depth to 70 mm instead of 87 mm

1	0 014 81	For 1-row cabinets Cat.No 0 014 41/51
1	0 014 82	For 2-row cabinets Cat.No 0 014 42/52
1	0 014 83	For 3-row cabinets Cat.No 0 014 43/53
1	0 014 84	For 4-row cabinets Cat.No 0 014 44/54

#### Flush-mounting kit for dry partitions

For installation of Nedbox flush-mounting cabinets in dry partitions

1	0 014 90	For installation of Nedbox flush-mounting cabinets in dry partitions
1	0 014 91	Key lock for Cat.Nos 6 012 42/43/44 and 6 014 41/42/43/44/51/52/53/54

## Flush-mounting cabinets Nedbox

12 to 48 modules

### Distribution cabinets 1, 2, 3 or 4 rows of 12 modules

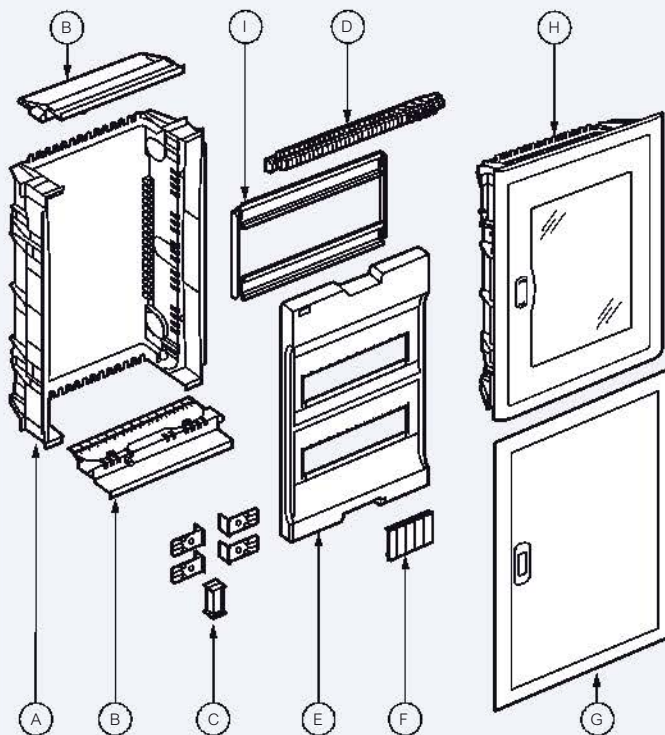

A : flush-mounting box  
B : cable entry plate  
C : wall anchors (fasteners) for masonry  
D : screw terminal blocks  
E : removable faceplate  
F : blanking plates  
G : metal door  
H : transparent door  
I : removable chassis

### Dimensions

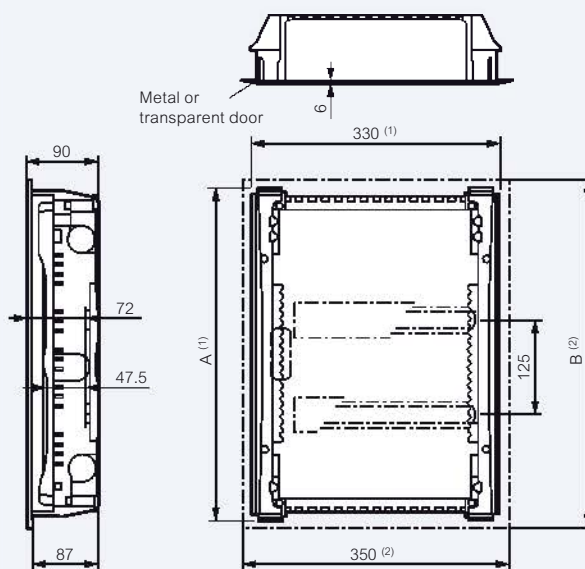

	1 row	2 rows	3 rows	4 rows
A : flush-mounting box height (mm)	305	430	555	680
B : door height (mm)	335	460	585	710

### Number of connections per terminal block and number of blanking plates supplied per cabinet

Number of rows	Terminal blocks Screw connection		Number of blanking plates supplied per cabinet 5 modules
	6 - 25 mm <sup>2</sup>	1.5 - 16 mm <sup>2</sup>	
1	1	12	1
2	1	16	1
3	1	21	2
4	1	36	2

1: Flush-mounting box dimensions

2: Door dimensions

# Surface mounting cabinets XL<sup>3</sup> 125

from 18 to 72 modules



Technical characteristics p. 201

IP 40 - IK 09 with door  
 IP 30 - IK 08 without door  
 Class II  
 Self-extinguishing: resistance to incandescent wire 650 °C  
 Conform to IEC 60439-3 and IEC 60670-24  
 Allows to achieve assemblies conform to IEC 61439-3

Pack	Cat.Nos	Surface-mounting distribution cabinets																									
		Capacity 18 modules per row White RAL 9003 Fully reversible cabinet (base, door and faceplates) Supplied with: - removable and pivoting chassis with  rails fitted. Rails can be individually removed for easy cabling on site - removable cable entry plate (top and bottom) - removable faceplates (for each row) - IP 2X screw terminal blocks for neutral and earth - blanking plates (5 modules, separable per module or 1/2 module) - 1 sheet of self-adhesive labels for circuit identification (marking per module) Spacing between rails 150 mm Adjustable  rail (2-position) for fitting modular equipment or DPX <sup>3</sup> 160 moulded case circuit breakers Can be fitted with perforated plates and solid faceplates for mounting non-modular products (2, 3 to 4-row cabinets) Doors to be ordered separately																									
		<table border="1"> <thead> <tr> <th>Number of rows</th> <th>Number of modules</th> <th>Height (mm)</th> <th>Width (mm)</th> <th>Depth (mm)</th> </tr> </thead> <tbody> <tr> <td>1</td> <td>18</td> <td>300</td> <td>450</td> <td>128</td> </tr> <tr> <td>1</td> <td>36</td> <td>450</td> <td>450</td> <td>128</td> </tr> <tr> <td>1</td> <td>54</td> <td>600</td> <td>450</td> <td>128</td> </tr> <tr> <td>1</td> <td>72</td> <td>750</td> <td>450</td> <td>128</td> </tr> </tbody> </table>	Number of rows	Number of modules	Height (mm)	Width (mm)	Depth (mm)	1	18	300	450	128	1	36	450	450	128	1	54	600	450	128	1	72	750	450	128
Number of rows	Number of modules	Height (mm)	Width (mm)	Depth (mm)																							
1	18	300	450	128																							
1	36	450	450	128																							
1	54	600	450	128																							
1	72	750	450	128																							
1	4 016 76																										
1	4 016 77																										
1	4 016 78																										
1	4 016 79																										

Pack	Cat.Nos	Doors - IP 40 - IK 09
		For XL <sup>3</sup> 125 distribution cabinets Fully reversible Can be equipped with lock and key n° 850 Cat.No 4018 51
		<b>White RAL 9003</b>
1	4 018 61	For distribution cabinet Cat.No 4 016 76
1	4 018 62	For distribution cabinet Cat.No 4 016 77
1	4 018 63	For distribution cabinet Cat.No 4 016 78
1	4 018 64	For distribution cabinet Cat.No 4 016 79
		<b>Transparent</b>
1	4 018 71	For distribution cabinet Cat.No 4 016 76
1	4 018 72	For distribution cabinet Cat.No 4 016 77
1	4 018 73	For distribution cabinet Cat.No 4 016 78
1	4 018 74	For distribution cabinet Cat.No 4 016 79

Pack	Cat.Nos	Accessories
2	4 018 51	<b>Key lock</b> To be fitted on white or transparent doors Supplied with key N° 850
2	4 018 45	<b>Horizontal or vertical joining kit</b> For joining 2 cabinets
1	4 018 56	<b>Fixing lugs</b> Set of 4 wall fixing lugs
2	4 018 44	<b>Document holder</b> Self-adhesive document holder for plans To be fitted on the cabinet
20	0 016 60	<b>Blanking plates</b> Separable per module or 1/2 module 5 modules - white RAL 9003
2	4 018 55	<b>Plain faceplates</b> For 2, 3 or 4-rows cabinets Allow fitting of non-modular equipments such as control and signalling units
2	4 018 53	<b>Perforated plates</b> To be used instead of the one  rail when integrating non-modular products For 18 modules cabinets. Height 150 mm
5	4 018 50	<b>Fixing accessory for Mosaic wiring devices</b> For fixing 2-module mechanisms on the side of the cabinet
1	4 018 57	<b>Fixing supports for terminal block</b> Set of 2 supports for installing terminal blocks or additional empty supports
5	4 048 21	<b>Empty supports</b> Empty support with 50 holes (length 385 mm) Takes unprotected screw terminal blocks
1	0 050 54	<b>IP 2X automatic connection terminal block</b> Conforms to standard IEC 60998-2-1/2-2 Takes flexible and rigid wires Disconnect using a flat screwdriver (3.5 mm) 5 x 6 to 25 mm <sup>2</sup> screw terminals + 5 x 6 to 35 mm <sup>2</sup> screw terminals + 45 x 1.5 to 4 mm <sup>2</sup> automatic terminals Length: 385 mm

# XL<sup>3</sup>-N 125 "MCB dedicated" and XL<sup>3</sup>-N 250 3-phase distribution boards

from 12 to 54 poles



6 024 54



6 024 61



6 024 90

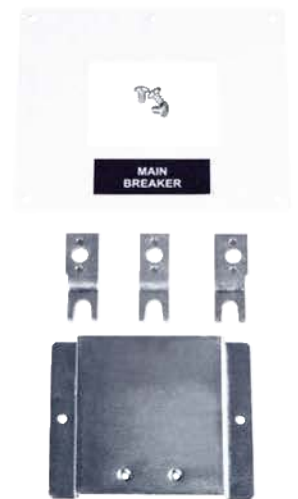

6 024 91

3-phase distribution boards for DIN-rail mounting circuit breakers

IP 40 - IK 08 with door

Conform to standard IEC 61439-3; Type tested; ASTA certified

Maximum voltage 480 V~; Rated short-time withstand current (I<sub>cw</sub>): 17 kA 0.2 s

Rated peak withstand current (I<sub>pk</sub>): 34 kA

Ambient temperature: 50 °C continuously

Zinc coated metal; Grey RAL 7035

Supplied with: surface or flush-mounting box, reversible door with handle, faceplate, fully isolated tin plated copper busbar

The number of holes of earth and neutral terminal blocks are equal to the number of outgoing devices

Pack	Cat.Nos		<b>XL<sup>3</sup>-N 125 "MCB dedicated" distribution boards</b>	
	Flush-mounting	Surface mounting	<b>Maximum rating 125 A</b>	
			Equipped with mounting kit for main circuit breaker (3P, 1 module/pole, DIN rail mounting MCBs only)	
			No of poles (outgoing terminals)	No of 3P ways
1	<b>N</b> 6 027 20	<b>N</b> 6 027 40	12	4
1	6 027 21	6 027 41	18	6
1	6 027 22	6 027 42	24	8
1	6 027 23	6 027 43	30	10
1	6 027 24	6 027 44	36	12
1	6 027 25	6 027 45	42	14
1	6 027 26	6 027 46	48	16
1	6 027 27	6 027 47	54	18

Pack	Cat.Nos		<b>XL<sup>3</sup>-N 250 distribution boards</b>	
	Flush-mounting	Surface mounting	<b>Maximum rating 125 A</b>	
			To be equipped with mounting kit for main circuit breaker (DIN-rail mounting MCBs or DRX 100 or DPX <sup>3</sup> 160 MCCBs)	
			No of poles (outgoing terminals)	No of 3P ways
1	6 024 50	6 024 70	12	4
1	6 024 51	6 024 71	18	6
1	6 024 52	6 024 72	24	8
1	6 024 53	6 024 73	30	10
1	6 024 54	6 024 74	36	12
1	6 024 55	6 024 75	42	14
1	6 024 56	6 024 76	48	16
1	6 024 57	6 024 77	54	18

Pack	Cat.Nos		<b>Maximum rating 250 A</b>	
			To be equipped with mounting kit for main circuit breaker (DRX 250 or DPX <sup>3</sup> 250 MCCBs)	
			No of poles (outgoing terminals)	No of 3P ways
1	6 024 58	6 024 78	18	6
1	6 024 59	6 024 79	24	8
1	6 024 60	6 024 80	30	10
1	6 024 61	6 024 81	36	12
1	6 024 62	6 024 82	42	14
1	6 024 63	6 024 83	48	16
1	6 024 64	6 024 84	54	18

Pack	Cat.Nos	<b>Mounting kits for main circuit breakers</b>
		Consisting of fixing device (DIN rail or fixing plate), faceplate and connection terminals
		<b>For XL<sup>3</sup>-N 250 distribution boards</b>
1	6 024 90	For 3P, 1 module/pole, DIN-rail mounting MCBs (for 125 A rating)
1	6 024 91	For DRX 125 3P MCCBs (for 125 A rating)
1	6 024 92	For DRX 250 3P MCCBs (for 250 A rating)
1	<b>N</b> 6 027 96	For DPX <sup>3</sup> 160 3P MCCBs
1	6 027 97	For DPX <sup>3</sup> 250 3P MCCBs

Pack	Cat.Nos	<b>Accessories</b>
		<b>Fixing supports for terminal blocks</b>
1	6 024 93	Kit consisting of 2 insulated fixing supports for terminal blocks for earth
		<b>Insulating caps</b>
20	6 024 94	For protecting unused outgoing terminals of the busbar
		<b>Blanking plate RAL 7035</b>
		Separable into modules or 1/2 modules
10	0 016 65	18 modules
		<b>Key lock</b>
5	<b>N</b> 6 027 95	For XL <sup>3</sup> -N 125 "MCB dedicated" and XL <sup>3</sup> -N 250 distribution boards
		<b>IP 41 kit</b>
5	<b>N</b> 6 027 98	For XL <sup>3</sup> -N 250 distribution boards

## Flush-mounting cabinets XL<sup>3</sup> 160

"ready to use" distribution cabinets



0 200 13 + door 0 202 83 (p. 200)

### Doors and equipment p. 200

Fireproof to 750 °C/5 s in accordance with IEC 60695-2-1 for installation in public buildings

Supplied complete:

- metal flush-mounting box,
- removable chassis with rails fitted,
- brass bar for protective conductors fitted: 36 holes 1.5 to 10 mm<sup>2</sup>, 2 x 35 mm<sup>2</sup> holes,
- finishing frame and plastic faceplates

Flush-mounting depth: 100 mm min.

Capacity: 24 modules per row

RAL 7035

Doors to be ordered separately (p. 200)

Can take DPX<sup>3</sup> 160 units

IP 40 – IK 08 with door

IP 30 – IK 04 without door

Pack	Cat.Nos	Fully modular cabinets				Box		200
		No of rows	No of modules	Front panel Height (mm)	Front panel Width (mm)	Height (mm)	Width (mm)	
1	0 200 13	3	72	695	670	640	617	150
1	0 200 14	4	96	845	670	790	617	150
1	0 200 15	5	120	995	670	940	617	150
1	0 200 16	6	144	1145	670	1090	617	150

Fixing accessory	
1	0 200 10 For hollow partition

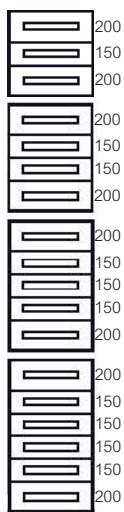

## Flush-mounting cabinets XL<sup>3</sup> 160

"ready to use" distribution cabinets

### Installation principle

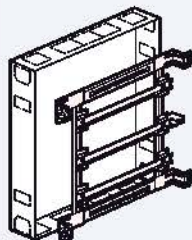

Removable chassis

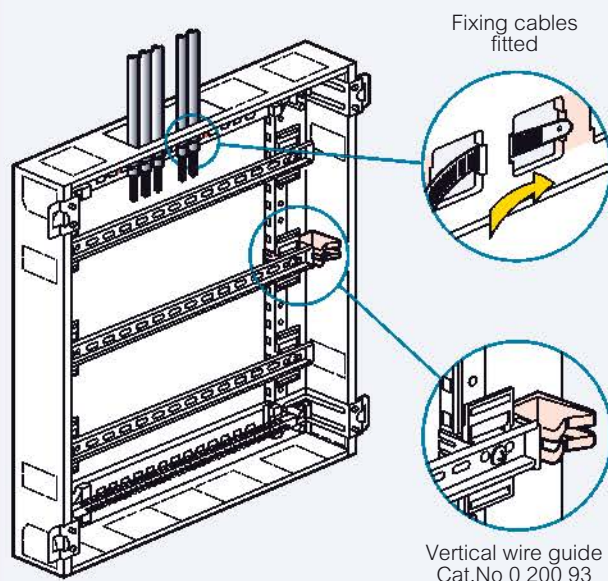

### Dimensions

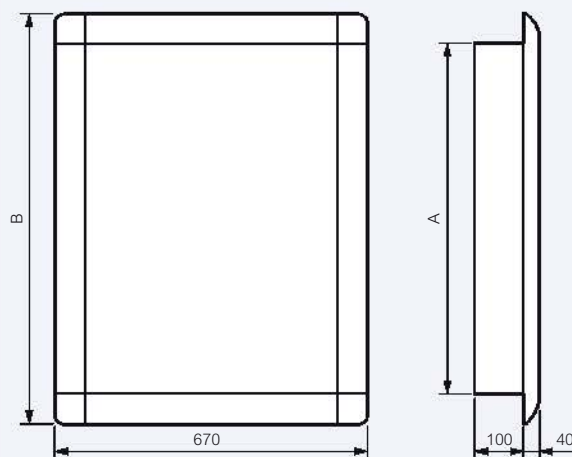

Cat.Nos	A (mm)	B (mm)
0 200 13	640	695
0 200 14	790	845
0 200 15	940	995
0 200 16	1090	1145



# Surface mounting cabinets XL<sup>3</sup> 160

"ready to use" distribution cabinets



Technical characteristics **p. 201**  
Doors and equipment **p. 200**

Removable chassis with rails fitted  
Brass bar for protective conductors fitted: 36 holes 1.5 to 10 mm<sup>2</sup> and 2 x 35 mm<sup>2</sup> holes. Capacity 24 modules per row. RAL 7035  
Supplied complete with rails and faceplates. Doors to be ordered separately (p. 200)  
For creating assemblies certified in accordance with IEC EN 61439-1  
Removable side panels. Removable, separable top and bottom panels for inserting adjustable cable gland plate

Pack	Cat.Nos	<b>XL<sup>3</sup> 160 metal cabinets</b>				
		Fireproof to 750 °C/5 s in accordance with IEC 60695-2-1 for installation in public buildings IP 43 – IK 08 with seal and door IP 40 – IK 08 with door IP 30 – IK 07 without door				
		<b>Fully modular</b> Can take DPX <sup>3</sup> 160				
		No of rows	No of modules	Height (mm)	Width (mm)	Depth (mm)
1	0 200 02	2	48	450	575	147
1	0 200 03	3	72	600	575	147
1	0 200 04	4	96	750	575	147
1	0 200 05	5	120	900	575	147
1	0 200 06	6	144	1050	575	147
		<b>Fully modular with DPX<sup>3</sup> 160 space</b>				
1	0 200 45	5	120	900	575	147
1	0 200 46	6	144	1050	575	147

Pack	Cat.Nos	<b>XL<sup>3</sup> 160 insulating cabinets</b>				
		Enclosures for creating class II (or totally isolated) assemblies in accordance with IEC EN 61439-1/3 IP 43 – IK 07 with seal and door IP 40 – IK 07 with door IP 30 – IK 04 without door Wire guide rings for vertical wiring Can take DPX <sup>3</sup> 160				
		No of rows	No of modules	Height (mm)	Width (mm)	Depth (mm)
1	0 200 52	2	48	450	575	147
1	0 200 53	3	72	600	575	147
1	0 200 54	4	96	750	575	147
1	0 200 55	5	120	900	575	147
1	0 200 56	6	144	1050	575	147
		<b>Accessories for metal cabinets</b>				
1	0 200 20	<b>Cable entry plates</b> Additional adjustable plate				
1	0 200 35	<b>Cable fixing support</b> Holds cable in place on entry to cabinet				
1	0 201 00	<b>Wall mounting lugs</b> Set of 4 metal lugs for IP 43 cabinets and enclosures				
1	0 200 21	<b>Plate with knock-out entries</b> 2 x Ø4 to 32 mm and 22 x Ø4 to 20 mm				
		<b>Accessories for insulating cabinets</b>				
1	0 201 50	<b>Wall mounting lugs</b> Set of 4 plastic lugs for insulating cabinets				
1	0 200 71	<b>Plate with knock-out entries</b> 2 x Ø4 to 32 mm and 22 x Ø4 to 20 mm				

# XL<sup>3</sup> 160

doors, equipment, wiring, connection of protective conductor



0 202 55



0 200 00



0 202 73

0 202 83



0 203 99



0 200 93



0 373 00

Pack	Cat.Nos		Doors
			For XL <sup>3</sup> 160 flush and surface mounting cabinets Supplied with handle with interchangeable barrels (to be ordered separately)
			<b>Curved</b> Faceplate/door distance: metal - 57 mm For cabinet/enclosure Height (mm):
		Metal	450
1		0 202 52	600
1		0 202 53	750
1		0 202 54	900
1		0 202 55	1050
1		0 202 56	
		Metal	
		Glass	
1	0 202 72 <sup>1</sup>	0 202 82 <sup>1</sup>	450
1	0 202 73 <sup>1</sup>	0 202 83 <sup>1</sup>	600
1	0 202 74 <sup>1</sup>	0 202 84 <sup>1</sup>	750
1	0 202 75 <sup>1</sup>	0 202 85 <sup>1</sup>	900
1	0 202 76 <sup>1</sup>	0 202 86 <sup>1</sup>	1050

Pack	Cat.Nos	Equipment for doors
		<b>Key barrels for metal or transparent doors</b> Supplied with a set of 2 keys
1	0 202 91	Type 405
1	0 202 92	Type 455
1	0 202 93	Type 1242E
1	0 202 94	Type 2433A
1	0 201 30	<b>Seal for IP 43 protection</b> Supplied ready to use length 5.5 m for cabinets (width 660 and 910 mm), enclosures and cable sleeves

Pack	Cat.Nos	Self-adhesive document holders for plan																			
20	0 365 80	<b>Open - RAL 7035</b>																			
20	0 365 81																				
		<table border="1"> <thead> <tr> <th colspan="2">External dim.</th> <th colspan="2">Internal dim.</th> <th rowspan="2">Depth (mm)</th> </tr> <tr> <th>Height (mm)</th> <th>Width (mm)</th> <th>Height (mm)</th> <th>Width (mm)</th> </tr> </thead> <tbody> <tr> <td>235</td> <td>340</td> <td>200</td> <td>310</td> <td>18</td> </tr> <tr> <td>165</td> <td>260</td> <td>130</td> <td>230</td> <td>18</td> </tr> </tbody> </table>	External dim.		Internal dim.		Depth (mm)	Height (mm)	Width (mm)	Height (mm)	Width (mm)	235	340	200	310	18	165	260	130	230	18
External dim.		Internal dim.		Depth (mm)																	
Height (mm)	Width (mm)	Height (mm)	Width (mm)																		
235	340	200	310	18																	
165	260	130	230	18																	
1	0 365 82	<b>Closed - RAL 9002</b> Rigid plastic - IP 50 Internal dim.: 324 x 120 x 18 mm																			
10	0 097 99	<b>Transparent</b> Flexible plastic - A4 - 305 x 220 mm																			

Pack	Cat.Nos	Equipment for cabinet with DPX <sup>3</sup> 160 space
1	0 200 00	<b>Universal rail</b> Rail
1	0 203 60	<b>Modular faceplate</b> Height 300 mm
1	0 203 91	<b>Solid faceplate</b> Height 100 mm

1: Not suitable for Vistop with front handle

Pack	Cat.Nos	Equipment for fully modular cabinets
		<b>Adaptor for mounting on  rail</b>
1	4 210 71	For DPX <sup>3</sup> 160 without side motor-driven handle
1	4 210 73	For DPX <sup>3</sup> 160 with residual current protection without side motor-driven handle
1	4 210 68	For all DPX <sup>3</sup> 160 with side motor-driven handle
1	4 210 58	For DPX <sup>3</sup> supply inverter, fixed version
1	4 210 59	For DPX <sup>3</sup> supply inverter, plug-in version
		<b>Rail height spacer</b> Fits on a rail ; used to mount on the same row DX and DPX <sup>3</sup> /DPX-IS mounted on plate Cat.Nos 0 262 08/09/39
1	4 052 26	For 20 modules
		<b>Blanking plates RAL 7035</b> For metal or plastic faceplates
20	0 200 51	24 modules, smooth adjustable strip
10	0 016 65	18 modules, separable per module or 1/2 module
		<b>Clip-on holders for adhesive labels</b> Supplied with sheet of labels for marking rows on faceplate
10	0 203 99	24 modules
		<b>Wiring</b>
		<b>Wire guide</b> For horizontal wiring Fits directly on the rails
10	0 200 94	Takes brass bar Cat.No 0 373 00 and 12 x 4 bar with clamps Cat.No 0 373 02
1	0 200 93	For vertical wiring Fits directly on cabinet chassis - Set of 2
		<b>Ducting support</b> For direct vertical mounting of Lina 25 ducting Fits directly on cabinet chassis - Set of 2
1	0 200 70	
		<b>Finishing strip</b> For a perfect finish at the join between DLP trunkink and XL <sup>3</sup> cabinet or enclosures RAL 7035
1	0 201 60	

Pack	Cat.Nos	Connection of protective conductors
		<b>Additional brass bar</b> Length 416 mm, 12 x 6.5 mm cross-section Fits directly on the supports integrated in XL <sup>3</sup> 160 cabinet or on rail  with wire guides Cat.No 0 200 94 or on the support end stop Cat.No 0 375 12 - 36 holes Ø5.3 mm (1.5 to 10 mm <sup>2</sup> ) - 2 holes Ø9 mm (35 mm <sup>2</sup> )
1	0 373 00	
		<b>Support for IP 2X terminal block</b> Set of 2 supports Fit directly at the back of cabinets (horizontal or vertical position) Takes 12 x 2 flat bar Cat.No 0 048 19 (p. 180)
1	0 200 50	
		<b>Equipotential link conductor</b> Length 350 mm Cross-section 6 mm <sup>2</sup> , ensures equipotential continuity when fitting auxiliaries on door (Osmoz signalling units > 50 V)
1	0 373 85	

## Surface mounting cabinets XL<sup>3</sup> 125

from 18 to 72 modules

### Number of connections per neutral and earth terminal block (supplied with enclosure)

Enclosure Cat.Nos	Neutral terminal blocks Screw connection		Earth terminal blocks Screw connection	
	6 - 25 mm <sup>2</sup>	1.5 - 16 mm <sup>2</sup>	6 - 25 mm <sup>2</sup>	1.5 - 16 mm <sup>2</sup>
4 016 76	1	17	1	17
4 016 77	1	21	1	21
4 016 78	1	26	1	26
4 016 79	1	34	1	34

### Number of blanking plates supplied per enclosure

Enclosure Cat.Nos	Number of blanking plates 5 modules
4 016 76	1
4 016 77	2
4 016 78	3
4 016 79	3

### Dimensions

Front view

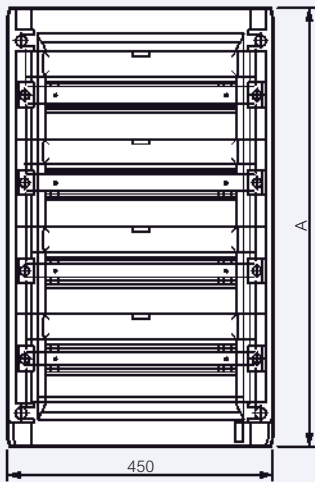

Side view without door



Side view with door



Fixing centres and distance between rails

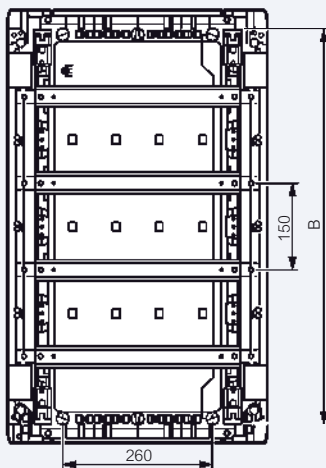

Enclosure Cat.Nos	A (mm)	B (mm)
4 016 76	300	250
4 016 77	450	365
4 016 78	600	515
4 016 79	750	665

## Surface mounting cabinets XL<sup>3</sup> 160

"ready to use" distribution cabinets

### Installation principle

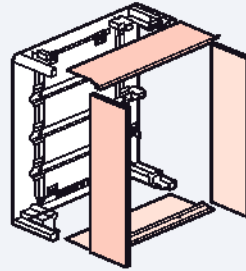

Side panels can be removed separately

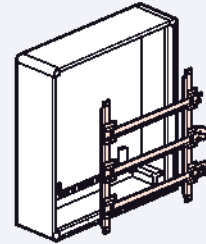

Removable chassis

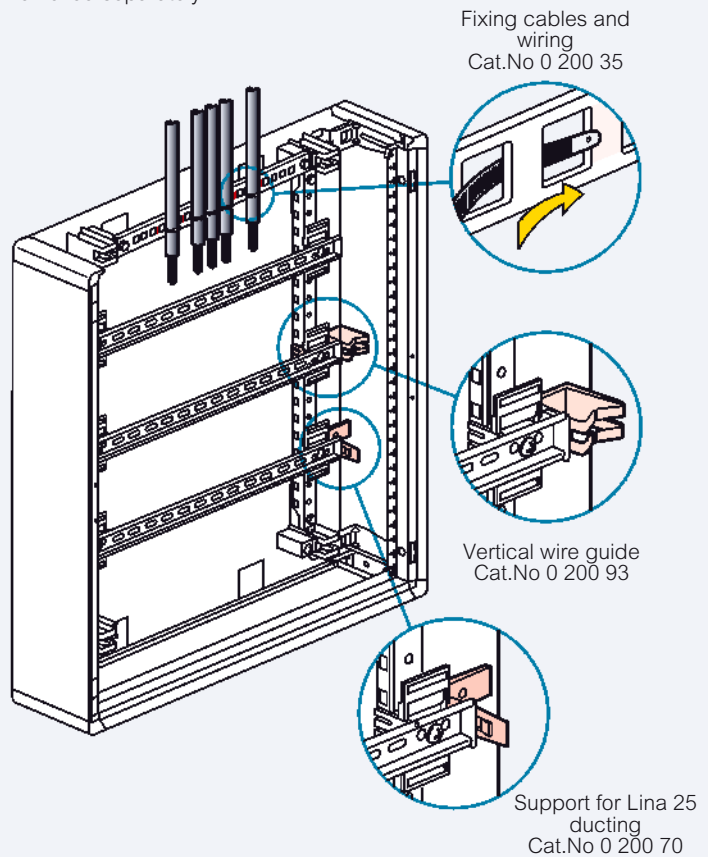

### Dimensions

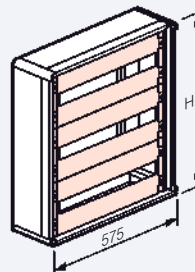

Cat.Nos	H (mm)
0 200 02	450
0 200 03	600
0 200 04	750
0 200 05	900
0 200 06	1050
0 200 45	900
0 200 46	1050
0 200 52	450
0 200 53	600
0 200 54	750
0 200 55	900
0 200 56	1050

With flat door



With curved door (metal)



	A (mm)
Metal	38
Glass	34



# Be free to organize your enclosure

XL<sup>3</sup> 400 self-assembly cabinets and enclosures, IP 43 metal or insulated

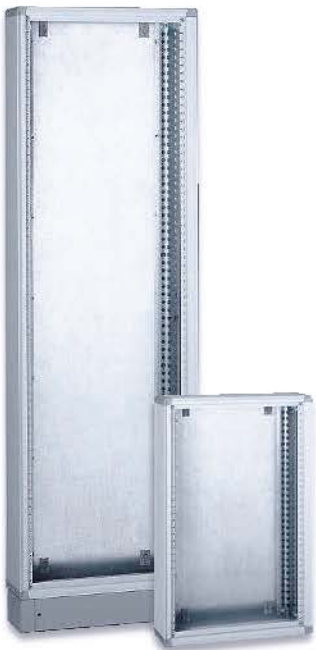

XL<sup>3</sup> 400 cabinets & enclosures p. 204

### MAIN BENEFITS

- Optimised transport and stocking thanks to flat packaging
- Optimised use of space inside enclosures thanks to external cable sleeve that can be equipped with DPX<sup>3</sup> MCCBs
- Takes: DIN rail equipment, DPX<sup>3</sup>, DPX-IS and Vistop ≤ 400 A

## OPTIMISED DISTRIBUTION HX<sup>3</sup>/VX<sup>3</sup>

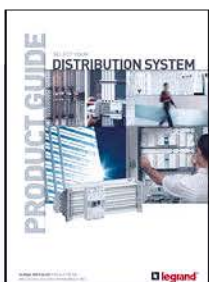

Full offer of optimised distribution available on request.

Download the product guide on [www.docexport.legrand.com](http://www.docexport.legrand.com)

Device	Fixing	Position	
<b>FIXING ON DIN-RAIL</b>			
<b>Modular devices &lt; 63 A</b>	Cabinet or enclosure	vertical	
	Cable sleeve	vertical	
<b>Modular devices &gt; 63 A</b>	Cabinet or enclosure	vertical	
	Cable sleeve	vertical	
<b>Vistop 63 to 160 A</b>	Cabinet or enclosure	vertical	
<b>DPX-IS 250</b>	Cabinet or enclosure	vertical	
<b>FIXING ON PLATE</b>			
<b>DPX<sup>3</sup> 160</b> (Combination possible with DPX <sup>3</sup> 250)	Cabinet or enclosure	vertical	
		horizontal	
	Cable sleeve	vertical	
<b>DPX<sup>3</sup> 250</b> (Combination possible with DPX <sup>3</sup> 160)	Cabinet or enclosure	vertical	
		horizontal	
	Cable sleeve	vertical	
<b>DPX-IS 250</b>	Cabinet or enclosure	vertical	
	Cable sleeve	vertical	
<b>DPX<sup>3</sup> 630</b>	Cabinet or enclosure	vertical	
		horizontal	
	Cable sleeve	vertical	
<b>DPX-IS 630</b>	Cabinet or enclosure	vertical	

1: Cat.Nos 4 210 73/74 for DPX<sup>3</sup> with electronic earth leakage module

	Type of device	Fixing device	Fixing plate	Faceplate for devices	
				Height (mm)	Metal
		0 202 06 0 202 01	-	150	0 203 00
		0 202 03	-	150	0 203 03
		0 202 06 0 202 01	-	200	0 203 01
		0 202 03	-	200	0 203 04
		0 202 06 0 202 01	-	200	0 203 01
	with modular devices	0 202 06	0 262 09	300	0 203 10
	with or without e.l.c.bs and without direct rotary handle	-	0 202 11 + 4 210 71/73 <sup>1</sup>	300	0 203 10
	with or without e.l.c.bs and with direct rotary handle	-	0 202 11 + 4 210 68	300	0 203 10
	direct rotary handle <sup>(1)</sup>	-	0 202 09	300	0 203 09
	manual supply inverter <sup>(2)</sup>	-	0 202 11 + 4 210 58	300	0 203 10
	with or without e.l.c.b	-	0 202 13	150	0 203 13
	with or without e.l.c.b	-	0 202 17	300	0 203 18
	with or without e.l.c.b and without side motor-driven handle	-	0 202 11 + 4 210 72/74 <sup>1</sup>	300	0 203 10
	with or without e.l.c.b and with side motor-driven handle	-	0 202 11 + 4 210 69	300	0 203 10
	direct rotary handle <sup>(1)</sup>	-	0 202 09	300	0 203 09
	manual supply inverter <sup>(2)</sup>	-	0 202 11 + 4 210 58	300	0 203 10
	with or without e.l.c.bs	-	0 202 15	200	0 203 17
	with or without e.l.c.bs	-	0 202 17	300	0 203 18
	device only in central position		0 202 05	300	0 203 10
	device only		0 202 17 + 0 262 39	300	0 203 18
	device only centred		0 202 21	400	0 203 21
	centred with e.l.c.bs		0 202 23	600	0 203 23
	without downstream e.l.c.bs		0 202 25	300	0 203 25
	device only		0 202 28	400	0 203 28
	with downstream e.l.c.bs		0 202 29	800	0 203 29
	device only		0 202 07	400	0 203 07

## Distribution cabinets and enclosures XL<sup>3</sup> 400



0 201 19



0 201 39



0 201 05

Dimensions and installation principle **see e-catalogue**

Take devices up to 400 A

Fireproof to 750 °C/5 s in accordance with IEC 60 695-2 for installation in public buildings (up to 100 kVA for Class II cabinets)

Capacity: 24 modules per row

Enclosures RAL 7035, plinths RAL 7004

Door to be ordered separately

Supplied flat with functional uprights fitted on the back, adjustable cable entry plate and joining accessories (horizontal and vertical)

Pack	Cat.Nos	<b>Metal cabinets</b>				
		IP 43 - IK 08 with kit and door IP 40 - IK 08 with door IP 30 - IK 07 without door				
		<b>To be equipped</b>				
		Height (mm)	Faceplate height (mm)	total (mm)	Width usable (mm)	Depth (mm)
1	0 201 03	600	550	575	515	175
1	0 201 04	750	700	575	515	175
1	0 201 05	900	850	575	515	175
1	0 201 06	1050	1000	575	515	175
1	0 201 07	1200	1150	575	515	175
1	0 201 08	1500	1450	575	515	175
		<b>External cable sleeves</b>				
1	0 201 23	600	550	310	250	175
1	0 201 24	750	700	310	250	175
1	0 201 25	900	850	310	250	175
1	0 201 26	1050	1000	310	250	175
1	0 201 27	1200	1150	310	250	175
1	0 201 28	1500	1450	310	250	175

Pack	Cat.Nos	<b>Metal enclosures</b>				
		IP 43 - IK 08 with kit and door IP 40 - IK 08 with door IP 30 - IK 07 without door				
		<b>To be equipped</b>				
		Supplied with plinth, height 100 mm				
		Height (mm)	Faceplate height (mm)	total (mm)	Width usable (mm)	Depth (mm)
1	0 201 18	1600	1450	575	515	175
1	0 201 19	1900	1750	575	515	175
		<b>External cable sleeves</b>				
		Supplied with plinth, height 100 mm				
1	0 201 38	1600	1450	310	250	175
1	0 201 39	1900	1750	310	250	175

For XL<sup>3</sup> 400 insulating and IP 55 distribution cabinets, **Please, consult us**

For detailed dimensions and installation principle, **see e-catalogue**



# Doors and equipment for XL<sup>3</sup> 400



0 202 55



0 202 73



0 202 59



0 202 83



0 201 21

Pack	Cat.Nos		Metal doors
			Supplied with handle with interchangeable key barrels (to be ordered separately)
			<b>Curved</b>
			Faceplate/door distance: 57 mm
			For cabinet/enclosure Height (mm)
	Metal		
1	0 202 53		600
1	0 202 54		750
1	0 202 55		900
1	0 202 56		1050
1	0 202 57		1200
1	0 202 58		1500/1600
1	0 202 59		1900
			<b>Flat</b>
			Faceplate/door distance: metal-38 mm; glass-34mm
	Metal	Glass	
1	0 202 73 <sup>1</sup>	0 202 83 <sup>1</sup>	600
1	0 202 74 <sup>1</sup>	0 202 84 <sup>1</sup>	750
1	0 202 75 <sup>1</sup>	0 202 85 <sup>1</sup>	900
1	0 202 76 <sup>1</sup>	0 202 86 <sup>1</sup>	1050
1	0 202 77 <sup>1</sup>	0 202 87 <sup>1</sup>	1200
1	0 202 78 <sup>1</sup>	0 202 88 <sup>1</sup>	1500/1600
1	0 202 79 <sup>1</sup>	0 202 89 <sup>1</sup>	1900
			<b>Flat for cable sleeves</b>
			Faceplate/door distance: 38 mm
	Metal		
1	0 201 63		600
1	0 201 64		750
1	0 201 65		900
1	0 201 66		1050
1	0 201 67		1200
1	0 201 68		1500/1600
1	0 201 69		1900

Pack	Cat.Nos	Equipment for doors
		<b>Key barrels for metal or transparent doors</b>
		Supplied with a set of 2 keys
1	0 202 91	Type 405
1	0 202 92	Type 455
1	0 202 93	Type 1242 E
1	0 202 94	Type 2433 A
		<b>Seal for IP 43 protection</b>
1	0 201 30	Supplied ready to use length 5.5 m for cabinets (width 660 and 910 mm), enclosures and cable sleeves
		<b>Self-adhesive document holders for plan</b>
		<b>Open - RAL 7035</b>
		External dim.   Internal dim.
		Height (mm)   Width (mm)   Height (mm)   Width (mm)   Depth (mm)
20	0 365 80	235   340   200   310   18
20	0 365 81	165   260   130   230   18
		<b>Closed - RAL 9002</b>
1	0 365 82	Rigid plastic - IP 50 Internal dim.: 324 x 120 x 18 mm
		<b>Transparent</b>
10	0 097 99	Flexible plastic - A4 - 305 x 220 mm
		<b>Mounting accessories</b>
		<b>Plinths</b>
		Height 100 mm
1	0 201 10	For cabinets and enclosures
1	0 201 12	For cable sleeves
		<b>Cable entry plates</b>
1	0 201 20	Additional adjustable plate for XL <sup>3</sup> 400 metal
		<b>Wall mounting lugs</b>
1	0 201 00	Set of 4 metal lugs for IP 43 cabinets and enclosures
		<b>Plates with knock-out entries</b>
1	0 201 21	2 x Ø4 to 32 mm and 22 x Ø4 to 20 mm For XL <sup>3</sup> 400 metal

1: Not suitable for Vistop with front handle



Distribution equipment and accessories  
**p. 206 to 209**



For curved glass doors,  
**Please, consult us**

## Equipment for XL<sup>3</sup> 400

for modular devices, Vistop, DPX<sup>3</sup> 160/250 and DPX-IS 250 on rail



Installation principle **see e-catalogue**

Pack	Cat.Nos	Fixing rails
1	0 202 01	<b>1 position rail</b> For modular devices and Vistop up to 160 A For fixing on XL <sup>3</sup> 400 functional uprights only
1	0 202 06	<b>2 positions aluminium rail</b> For DPX <sup>3</sup> and DPX-IS 250 with plates Accepts HX <sup>3</sup> 125 A plug-in connection row distribution blocks For fixing on XL <sup>3</sup> 400 functional uprights only Accepts wire guide Cat.No 4 052 25 (p. 209)
		<b>Fixing plates for mounting DPX<sup>3</sup> 160/250 on rail</b>
1	4 210 71	For mounting DPX <sup>3</sup> 160/250 on aluminium rail Cat.No 0 202 06 or on plate Cat.No 0 202 11
1	4 210 73	For DPX <sup>3</sup> 160
1	4 210 74	For DPX <sup>3</sup> 160 with earth leakage module
1	4 210 68	For all DPX <sup>3</sup> 160 devices with side motor-driven handle
1	4 210 72	For DPX <sup>3</sup> 250
1	4 210 74	For DPX <sup>3</sup> 250 with earth leakage module
1	4 210 69	For all DPX <sup>3</sup> 250 devices with side motor-driven handle
		<b>Adaptor for mounting DPX-IS 250 on rail</b>
1	0 262 39	For mounting devices on aluminium rail Cat.No 0 202 06 and on plate Cat.No 0 202 11 For DPX-IS 250
		<b>Rail height spacer</b>
1	4 052 26	Designed for simultaneous mounting of modular devices and DPX <sup>3</sup> 160/250 and DPX-IS 250 devices mounted on rail Cat.No 0 202 06 or on plate Cat.No 0 202 11 For 20 modules

Pack	Cat.Nos	Metal faceplates
1	0 203 00	1/4 turn fastening and sealable <b>For modular devices</b> Height 150 mm
1	0 203 01	<b>For Vistop up to 160 A</b> Height 200 mm
1	0 203 10	<b>For DPX<sup>3</sup> or DPX-IS 250, and Vistop up to 160 A</b> Height 300 mm

## Equipment for XL<sup>3</sup> 400

for mounting on plate: DPX<sup>3</sup> 160, DPX<sup>3</sup> 250 and DPX-IS 250

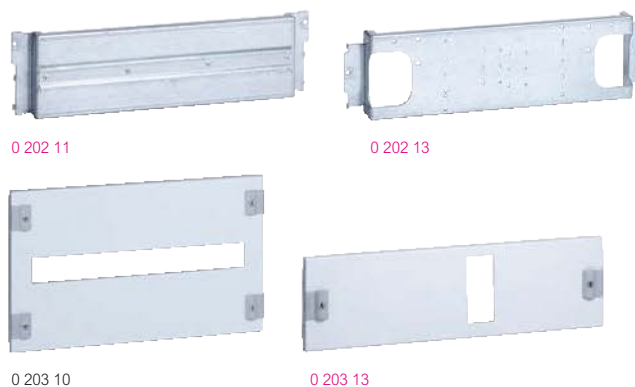

Pack	Cat.Nos	Plates for fixed version with front terminals
		Fit onto functional upright
		<b>Vertical mounting</b>
1	0 202 11	Equipped with a rail for fixing DPX <sup>3</sup> 160/250 or DPX-IS 250 <sup>1</sup> The DPX <sup>3</sup> or the DPX-IS 250 must be equipped with a fixing plate Cat.Nos 4 210 68/69/71/72/73/74 or Cat.No 0 262 39 or plate for manual supply inverter Cat.No 4 210 58 Designed for simultaneous mounting of DPX <sup>3</sup> 160/250 and DPX-IS and modular equipment (with spacer Cat.No 0 262 99)
1	0 202 09	Plate for DPX <sup>3</sup> 160/250 with direct rotary handle The DPX <sup>3</sup> must be equipped with a fixing plate Cat.Nos 4 210 68/69
		<b>Horizontal mounting</b>
1	0 202 13	For cut-out protection for cable passing, use seal Cat.No 0 202 40
1	0 202 15	For 1 DPX <sup>3</sup> 160 thermal-magnetic For 1 DPX <sup>3</sup> 250 or 1 DPX <sup>3</sup> 160 electronic release
		<b>Metal faceplates</b>
		1/4 turn fastening and sealable
1	0 203 10	<b>For DPX<sup>3</sup> and DPX-IS 250 in vertical position</b> Height 300 mm
1	0 203 11	Height 400 mm for DPX <sup>3</sup> 250 with terminal shields
1	0 203 09	Height 300 mm for DPX <sup>3</sup> 160/250 with direct rotary handle
1	0 203 13	<b>For DPX<sup>3</sup> 160 in horizontal position</b> Height 150 mm
1	0 203 17	<b>For DPX<sup>3</sup> 250 in horizontal position</b> Height 200 mm

1: Requires 300 mm height face plate, when installed at the top of the enclosure



## Equipment for XL<sup>3</sup> 400

for mounting on plate: DPX<sup>3</sup> 630 and DPX-IS 630



Installation principle **see e-catalogue**

Pack	Cat.Nos	
		<b>Plates for fixed version devices with front terminals</b>
		An additional rail can be installed  Fit onto functional uprights
		<b>Devices in vertical position</b>
1	0 202 07 <sup>1</sup>	For 1 DPX-IS 630
1	0 202 21 <sup>1</sup>	For 1 DPX <sup>3</sup> 630 in central position
1	0 202 23 <sup>1</sup>	For 1 DPX <sup>3</sup> 630 with earth leakage module in central position
		<b>Device in horizontal position</b>
		For cut-out protection for cable passing, use seal Cat.No 0 202 40 (p. 208)
1	0 202 25 <sup>1</sup>	For 1 DPX 630 without earth leakage module
		<b>Metal faceplates for devices in vertical position</b>
		1/4 turn fastening and sealable
1	0 203 07 <sup>1</sup>	<b>For DPX-IS 630</b> Height 300 mm
1	0 203 21 <sup>1</sup>	<b>For 1 DPX<sup>3</sup> 630 in central position</b> Height 400 mm
1	0 203 23 <sup>1</sup>	<b>For 1 DPX<sup>3</sup> 630 in central position with e.l.c.b.</b> Height 600 mm
		<b>Metal faceplates for devices in horizontal position</b>
		1/4 turn fastening and sealable
1	0 203 25	Height 300 mm for 1 DPX <sup>3</sup> 630

1: Limited to 400 A

## Equipment for XL<sup>3</sup> 400 cable sleeves

for mounting devices on rail or on plate



Installation principle **see e-catalogue**

Fixing on rail with faceplates for modular devices up to 160 A  
Fixing on plates with faceplates for DPX<sup>3</sup> 160, 250, DPX 250, 630 and DPX-IS 250

Pack	Cat.Nos	
		<b>Fixing on rail  modular devices and Vistop up to 160 A</b>
1	0 202 03	Comprising a rail  and 2 fixing brackets Fit onto functional uprights Take wire guides Cat.No 0 200 94 Capacity: 9 modules
		<b>1/4 turn faceplates for mounting on rail </b>
		1/4 turn fastening and sealable for devices on rail
1	0 203 03	<b>For modular devices</b> Height 160 mm
1	0 203 04	<b>For modular devices and Vistop up to 160 A</b> Height 200 mm
		<b>Plates for fixed version devices with front terminals</b>
		<b>Devices in vertical position</b>
		Fit onto functional uprights
1	0 202 17	For DPX <sup>3</sup> 160, DPX <sup>3</sup> 250 and DPX-IS 250
1	0 202 28 <sup>1</sup>	For DPX <sup>3</sup> 630
1	0 202 29 <sup>1</sup>	For DPX <sup>3</sup> 630, with downstream earth leakage module
		<b>Metal faceplates for mounting on plates</b>
		1/4 turn fastening and sealable for devices on plates
1	0 203 18	<b>For DPX<sup>3</sup> 160/250 and DPX-IS 250</b> Height 300 mm
1	0 203 27	Height 400 mm for DPX <sup>3</sup> 250 with terminal shields
1	0 203 28 <sup>1</sup>	<b>For DPX<sup>3</sup> 630</b> Height 400 mm
1	0 203 29 <sup>1</sup>	<b>For DPX<sup>3</sup> 630 with earth leakage module</b> Height 800 mm

1: Limited to 400 A

## Accessories and faceplates for XL<sup>3</sup> 400



0 202 41



0 201 60



0 200 92



0 202 04



0 201 35



0 201 45

Pack	Cat.Nos	Accessories
		<b>Perforated universal plates</b> Fit directly onto functional uprights
1	0 202 41	Height 200 mm for cabinets and enclosures
1	0 202 42	Height 300 mm for cabinets and enclosures
2	0 202 43	Height 300 mm for cable sleeves
		<b>Clips nuts for perforated plates</b>
100	0 364 40	For M4 screws
100	0 364 41	For M5 screws
		<b>Finishing strip</b>
1	0 201 60	For a perfect finish at the join between DLP trunking and XL <sup>3</sup> cabinets or enclosures RAL 7035
		<b>Universal rail</b> 
1	0 202 04	Fits onto functional uprights Width 515 mm
		<b>Universal adjustable fixing device</b>
1	0 202 02	Comprising a rail 2 and 2 adjustable fixing brackets Fits onto functional uprights of XL <sup>3</sup> 400
		<b>Insulating fixing support</b>
1	0 200 90	Set of 2 supports Fits directly on functional uprights in XL3 400/800 cabinets or enclosures For creating an insulated earth with 12 x 4 mm copper bar (Cat.No 0 373 49) or flat bar 12 x 2 mm (Cat.No 0 048 19) and IP 2X terminal block Also takes universal rails Cat.Nos 0 202 04, 0 206 05/54
		<b>Cable fixing support</b>
		For fixing ties for holding cables in place on entry to the cabinet
1	0 201 35	For cabinets and enclosures
1	0 201 37	For cable sleeves
		<b>Universal support</b>
		For mounting terminal blocks, earth terminals... Set of 3 metal supports
1	0 201 96	For internal cable sleeves
		<b>Divider</b>
1	0 201 90	For horizontal compartmentalisation
		<b>Clip nuts for functional uprights</b>
20	0 200 92	1/4 turn fastening on front panel Clip nuts for M6 screw
		<b>Screws</b>
50	0 200 91	M6 screws
		<b>Aerosol paint spray</b>
6	0 200 98	RAL 7035 - 400 ml
		<b>Lighting kit</b>
1	0 203 89	For mounting on supplied plate
		<b>Protection seal</b>
1	0 202 40	For cut-out protection on plate Length 20 m, can be cut to length

Pack	Cat.Nos	1/4 turn solid faceplates
		<b>For cabinets and enclosures</b> Fastening and sealable
		Height (mm)
1	0 203 40	50
1	0 203 41	100
1	0 203 42	150
1	0 203 43	200
1	0 203 44	300
		<b>For cable sleeves</b>
1	0 201 41	50
1	0 201 42	100
1	0 201 40	200
1	0 201 43	550
1	0 201 44	700
1	0 201 45	850
1	0 201 46	1000
1	0 201 47	1150
1	0 201 48	1450
1	0 201 49	1750
		<b>Blanking plates</b> RAL 7035
20	0 200 51	24 modules, smooth adjustable strip
10	0 016 65	18 modules, separable into modules or 1/2 modules
		<b>Clip-on holder for adhesive labels</b>
10	0 203 99	Supplied with sheet of labels for marking rows on faceplate

# Wiring and connection accessories for XL<sup>3</sup> 400



0 201 70



0 373 00



0 201 93



2 x 0 375 12 + 1 x 0 373 00 mounted

Pack	Cat.Nos	Wiring	Pack	Cat.Nos	Connection of protective conductor (continued)																												
1	0 201 70	<b>Lina 25 ducting fixing support</b> Set of 2 supports For fixing and height adjustment of Lina 25 ducting: - vertical: 40 x 60 or 40 x 80 - horizontal: 40 x 60 Supplied with insulating rivets Fit directly onto functional uprights Can not be used for 150 mm spacing between rails, except when equipped with Lina 25 ducting 25 mm width  <b>Lina 25 ducting</b> Length: 2 m <table border="1"> <thead> <tr> <th></th> <th>Width (mm)</th> <th>Height (mm)</th> </tr> </thead> <tbody> <tr> <td>56</td> <td>25</td> <td>60</td> </tr> <tr> <td>48</td> <td>40</td> <td>60</td> </tr> <tr> <td>40</td> <td>40</td> <td>80</td> </tr> </tbody> </table> <b>Insulating screw</b> M6 x 10  <b>Insulating rivet</b> For fixing Lina 25 ducting on functional uprights  <b>Wire guides</b> For horizontal wiring Fits directly on rail Takes brass bar Cat.No 0 373 00 and bar 12 x 4 with clamps Cat.No 0 373 02  For vertical wiring Fits directly onto functional uprights in XL <sup>3</sup> 400 cabinets and enclosures  For horizontal wiring Fits directly on to 2-position aluminium rail Accepts Lina 25 ducting covers		Width (mm)	Height (mm)	56	25	60	48	40	60	40	40	80	1	0 373 85	<b>Equipotential link conductor</b> Length 350 mm Cross-section 6 mm <sup>2</sup> , ensures equipotential continuity when fitting auxiliaries on door (Osmoz signalling units > 50 V)  <b>No perforated copper bar</b> <table border="1"> <thead> <tr> <th>Cross section (mm)</th> <th>Permis. I (A)</th> <th>Length (mm)</th> </tr> </thead> <tbody> <tr> <td>12 x 4</td> <td>180</td> <td>991.5</td> </tr> </tbody> </table> <b>Connectors for bar 12 x 4 without holes</b> 1.5 to 4 mm <sup>2</sup> 6 to 16 mm <sup>2</sup> 10 to 35 mm <sup>2</sup> (supplied with M6 screws 5 mm)  <b>Copper bar with tapped holes</b> <table border="1"> <thead> <tr> <th>Cross section (mm)</th> <th>Permis. I (A)</th> <th>Tapped holes Ø (mm)</th> <th>Pitch</th> <th>Length (mm)</th> </tr> </thead> <tbody> <tr> <td>12 x 4</td> <td>160</td> <td>M5</td> <td>18</td> <td>990</td> </tr> </tbody> </table> <b>Connectors for 12 x 4 mm bar with tapped holes</b> 1 or 2 conductors from 1.5 to 10 mm <sup>2</sup> (supplied with Ø5 screws)  <b>Support end cap</b> For rails  15 mm depth and  EN 60715 7.5 mm (except rail fixed on plate) and 15 mm depth Takes the following protection or shielding bars: - Brass bar Cat.Nos 0 373 00/01 - Copper bar 12 x 4 mm with clamps Cat.No 0 373 02 - IP 2X terminal block with flat steel bar 12 x 2 mm Cat.No 0 048 19 - Copper bar 12 x 4 mm Cat.Nos 0 373 49 or 0 373 89 - Shielding bar 10 x 3 mm Cat.No 0 375 34 (p. 286)	Cross section (mm)	Permis. I (A)	Length (mm)	12 x 4	180	991.5	Cross section (mm)	Permis. I (A)	Tapped holes Ø (mm)	Pitch	Length (mm)	12 x 4	160	M5	18	990
	Width (mm)	Height (mm)																															
56	25	60																															
48	40	60																															
40	40	80																															
Cross section (mm)	Permis. I (A)	Length (mm)																															
12 x 4	180	991.5																															
Cross section (mm)	Permis. I (A)	Tapped holes Ø (mm)	Pitch	Length (mm)																													
12 x 4	160	M5	18	990																													
10	0 362 02 0 362 07 0 362 08		10	0 373 49																													
50	0 367 74		100	0 373 60 0 373 61 0 373 62																													
100	0 200 80		10	0 373 89																													
10	0 200 94		100	0 373 65																													
10	0 201 93		10	0 375 12																													
12	<b>N</b> 4 052 25																																
		<b>Connection of protective conductor</b>  <b>Flat bar 12 x 2</b> Takes IP 2X terminal blocks Fits onto functional uprights in XL <sup>3</sup> 400 cabinets and enclosures, or on insulating supports Cat.No 0 200 90 Length: 1 meter  <b>Additional brass bar</b> Length 416 mm, 12 x 6.5 mm cross-section Fits directly on integrated supports in XL <sup>3</sup> 160 cabinet or on rail  with wire guides Cat.No 0 200 94 or on support end stop Cat.No 0 375 12 - 36 holes Ø5.3 mm (1.5 to 10 mm <sup>2</sup> ) - 2 holes Ø9 mm (35 mm <sup>2</sup> )  <b>Brass bar for protective conductor</b> Length 456 mm, 12 x 6.5 mm cross-section - 36 holes Ø5.3 mm (1.5 to 10 mm <sup>2</sup> ) - 2 holes Ø9 mm (35 mm <sup>2</sup> ) - 4 holes Ø6.5 mm (2.5 to 16 mm <sup>2</sup> ) Fits onto functional uprights with supplied lugs  <b>Flat copper bar 12 x 4 with clamps</b> Supplied with clamp connectors (40 x 1.5 to 4 mm <sup>2</sup> , 4 x 6 to 16 mm <sup>2</sup> , 1 x 35 mm <sup>2</sup> ) Length 455 mm Fits onto functional uprights in XL <sup>3</sup> 400 cabinets and enclosures or on rail with wire guides Cat.No 0 200 94																															



# Fully adaptable enclosures

XL<sup>3</sup> 800 extendable cabinets and enclosures, 24 & 36 modules per row



XL<sup>3</sup> 800 cabinets & enclosures p. 212-213

### DISCOVER THE RANGE

- Extendable: 24 and 36 modules per row
- Two indexes of protection:
  - IP 43 up to 800 A, supplied flat with functional uprights
  - IP 55 up to 600 A, supplied without side panels
- Takes: DIN rail equipment, DPX<sup>3</sup>, DPX-IS and Vistop ≤ 800 A

## FROM IEC 60439 TO IEC 61439



XL<sup>3</sup> configurable assemblies guide to migration from IEC 60439 to IEC 61439  
**Download the guide on**  
[www.docexport.legrand.com](http://www.docexport.legrand.com)

Device	Fixing	Position	
<b>XL<sup>3</sup> 800 - 24 modules</b>			
<b>FIXING ON DIN-RAIL</b>			
<b>Modular devices &lt; 63 A</b>	Cabinet or enclosure	vertical	
<b>Modular devices &gt; 63 A</b>	Cabinet or enclosure	vertical	
<b>Vistop 63 to 160 A</b>	Cabinet or enclosure	vertical	
<b>DPX-IS 250</b>	Cabinet or enclosure	vertical	
<b>FIXING ON PLATE</b>			
<b>DPX<sup>3</sup> 160</b> (Combinaison possible with DPX <sup>3</sup> 250)	Cabinet or enclosure	vertical	
		horizontal	
<b>DPX<sup>3</sup> 250 and DPX<sup>3</sup> 160-125 electronic</b> (Combinaison possible with DPX <sup>3</sup> 160)	Cabinet or enclosure	vertical	
		horizontal	
<b>DPX-IS 250</b>	Cabinet or enclosure	vertical	
<b>DPX<sup>3</sup> 630</b>	Cabinet or enclosure	vertical	
		horizontal	
<b>DPX-IS 630</b>	Cabinet or enclosure	vertical	
	Cable sleeve	vertical	
<b>DPX-IS 1600</b>	Cabinet or enclosure	vertical	
<b>DPX<sup>3</sup> 1600</b>	Cabinet or enclosure	vertical	
		horizontal	
<b>XL<sup>3</sup> 800 - 36 modules</b>			
<b>FIXING ON DIN-RAIL</b>			
<b>Modular devices &lt; 63 A</b>	Cabinet or enclosure	vertical	
<b>Modular devices &gt; 63 A</b>	Cabinet or enclosure	vertical	
<b>Vistop 63 to 160 A</b>	Cabinet or enclosure	vertical	
<b>DPX-IS 250</b>	Cabinet or enclosure	vertical	
<b>FIXING ON PLATE</b>			
<b>DPX<sup>3</sup> 160</b> (combination possible with DPX <sup>3</sup> 250)	Cabinet or enclosure	vertical	
		horizontal	
<b>DPX<sup>3</sup> 250</b> (combination possible with DPX <sup>3</sup> 160)	Cabinet or enclosure	vertical	
		horizontal	
<b>DPX-IS 250</b>	Cabinet or enclosure	vertical	
<b>DPX<sup>3</sup> 630</b>	Cabinet or enclosure	vertical	
<b>DPX-IS 630</b>	Cabinet or enclosure	vertical	
<b>DPX<sup>3</sup> 1600</b>	Cabinet or enclosure	vertical	
		horizontal	

1: Cat.Nos 4 210 73/74 for DPX<sup>3</sup> with electronic earth leakage module  
 2: Faceplate supplied

	Type of device	Fixing device	Fixing plate	Height (mm)	Faceplate for device	
					1/4 turn	Screw
<b>XL<sup>3</sup> 800 - 24 modules</b>						
		0 206 01	-	150	0 208 00	0 209 00
		0 206 01	-	200	0 208 01	0 209 01
		0 206 01	-	200	0 208 01	0 209 01
	with modular devices	0 206 01	0 262 39	300	0 208 10	0 209 10
	without side motor-driven handle	-	0 206 11 + 4 210 71/73 <sup>(1)</sup>	300	0 208 10	0 209 10
	with side motor-driven handle	-	0 206 11 + 4 210 68	300	0 208 10	0 209 10
	direct rotary handle	-	0 206 08 + 4 210 71/73 <sup>(1)</sup>	300	0 208 05	0 209 05
	manual supply inverter	-	0 206 11 + 4 210 58	300	0 208 10	0 209 10
	motor-driven supply inverter	-	0 206 13 + 4 210 58	300	0 208 10	0 209 10
	with or without e.l.c.bs	-	0 206 15	150	0 208 13	0 209 13
	without side motor-driven handle	-	0 206 11 + 4 210 72/74 <sup>(1)</sup>	300	0 208 10 <sup>(2)</sup>	0 209 10
	with side motor-driven handle	-	0 206 11 + 4 210 69	300	0 208 10 <sup>(2)</sup>	0 209 10
	direct rotary handle	-	0 206 08 + 4 210 72/74 <sup>(1)</sup>	300	0 208 05	0 209 05
	manual supply inverter	-	0 206 11 + 4 210 58	300	0 208 10 <sup>(2)</sup>	0 209 10
	motor-driven supply inverter	-	0 206 13 + 4 210 58	300	0 208 10 <sup>(2)</sup>	0 209 10
	with or without e.l.c.bs	-	0 206 17	200	0 208 17	0 209 17
	device only in central position	-	0 206 05	300	0 208 10	0 209 10
	1 or 2 devices	-	0 206 05	300	0 208 06	0 209 06
	1 to 3 devices, no e.l.c.bs	-	0 206 20	400	0 208 20	0 209 20
	1 to 3 devices, with e.l.c.bs	-	0 206 22	600	0 208 22	0 209 22
	with or without e.l.c.bs	-	0 206 23	300	0 208 23	0 209 23
	device only	-	0 206 07	300	0 208 07	0 209 07
	device only	-	0 206 27	1550/1950	-	0 204 41/42
	device only	-	0 211 00	300	-	0 211 13
	device only	-	0 211 00	400	0 211 10	0 211 11
	device only	-	0 211 00	400	0 208 34	0 209 34
<b>XL<sup>3</sup> 800 - 36 modules</b>						
		0 206 51	-	150	-	0 209 50
		0 206 51	-	200	-	0 209 51
		0 206 51	-	200	-	0 209 51
	with modular devices	0 206 51	0 262 39	300	-	0 209 60
	without side motor-driven handle	-	0 206 61 + 4 210 71/73 <sup>(1)</sup>	300	-	0 209 60
	with side motor-driven handle	-	0 206 61 + 4 210 68	300	-	0 209 60
	manual supply inverter	-	0 206 61 + 4 210 58	300	-	0 209 60
	without side motor-driven handle	-	0 206 61 + 4 210 72/74 <sup>(1)</sup>	300	-	0 209 60
	with side motor-driven handle	-	0 206 61 + 4 210 69	300	-	0 209 60
	manual supply inverter	-	0 206 61 + 4 210 58	300	-	0 209 60
	1 or 2 devices	-	0 206 55	300	-	0 209 60
	no e.l.c.bs	-	0 206 70	400	-	0 209 70
	with e.l.c.bs	-	0 206 72	600	-	0 209 72
	device only	-	0 206 57	300	-	0 209 57
	device only	-	0 211 02	400	-	0 211 12
	device only	-	0 211 02	400	-	0 209 84

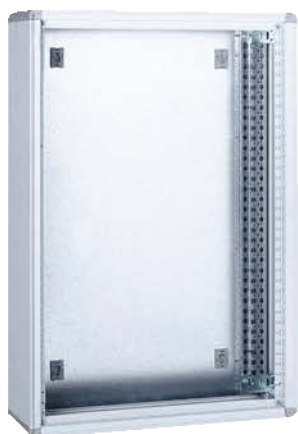

0 204 01



0 212 51



0 212 61

Dimensions and installation principle **see e-catalogue**

IP 43 - IK 08 with kit and door

IP 40 - IK 08 with door

IP 30 - IK 07 without door

Metal enclosures

Can take devices up to 800 A

Fireproof to 750 °C/5 s in accordance with IEC 60695-2-1

For installation in public buildings

Capacity: 24 and 36 modules per row

Cabinets RAL 7035, plinths RAL 7004

Supplied flat with functional uprights fitted on the back, adjustable cable entry plate and joining accessories (horizontal and vertical)

Pack	Cat.Nos	<b>Cabinets</b>				
		<b>Width 660 mm</b>				
		24 modules per row				
		Height (mm)	Faceplate height (mm)	Width (mm)		Depth (mm)
				external	usable	
1	0 204 01	1050	1000	660	600	230
1	0 204 02	1250	1200	660	600	230
		<b>Width 910 mm</b>				
		Can incorporate a cable sleeve				
		36 or 24 modules (if internal cable sleeve)				
1	0 204 06	1050	1000	910	850	230
1	0 204 07	1250	1200	910	850	230
		<b>Internal cable sleeves</b>				
		<b>Kit for internal cable sleeve</b>				
		Mounting on the right or left-hand side inside 910 mm wide cabinets				
		Comprising: upright and mounting accessories				
		For creating a cable sleeve usable width of 250 mm				
1	0 204 26	For cabinet height 1050 mm or 1095 mm, Cat.No 0 204 06/56				
1	0 204 27	For cabinet height 1250 mm or 1295 mm, Cat.No 0 204 07/57				
		<b>Solid faceplates with hinges and locks</b>				
1	0 204 46	For internal cable sleeves height 1050 or 1095 mm				
1	0 204 47	For internal cable sleeves height 1250 or 1295 mm				

Pack	Cat.Nos	<b>Doors</b>				
		Supplied with handle, interchangeable key barrels, to be ordered separately (p. 216)				
		2 points of locking: low and high				
		Distance faceplate/door:				
		- metal: 67 mm				
		- glass: 63 mm				
		<b>Curved</b>				
				Heigh (mm)	For cabinet	Width (mm)
1	0 212 51	Metal	Glass	1050		660
1	0 212 52			1250		660
1	0 212 56			1050		910
1	0 212 57			1250		910
		<b>IP 43 kit</b>				
1	0 201 30	Supplied ready to use				
		Lenght 5.5 m for cabinets (width 660 and 910 mm), enclosures and cable sleeves				



# Distribution enclosures, cable sleeves and doors XL<sup>3</sup> 800



Dimensions and installation principle **see e-catalogue**

IP 43 – IK 08 with kit and door  
 IP 40 – IK 08 with door  
 IP 30 – IK 07 without door

Metal enclosures. Can take devices up to 800 A

Fireproof to 750 °C/5 s in accordance with IEC 60695-2-1. For installation in public buildings

Capacity: 24 and 36 modules per row. Enclosures RAL 7035, plinths RAL 7004

Supplied flat with functional uprights fitted on the back, adjustable cable entry plate and joining accessories (horizontal and vertical)

Pack	Cat.Nos	<b>Enclosures</b>				
		Supplied with plinth, height 100 mm				
		<b>Width 660 mm</b>				
		24 modules per row				
		Height (mm)	Faceplate height (mm)	Width (mm)		Depth (mm)
				external	usable	
1	0 204 03	1550	1400	660	600	230
1	0 204 04	1950	1800	660	600	230
		<b>Width 910 mm</b>				
		Can incorporate a cable sleeve				
		36 or 24 modules (if internal cable sleeve)				
1	0 204 08	1550	1400	910	850	230
1	0 204 09	1950	1800	910	850	230

Pack	Cat.Nos	<b>Internal cable sleeves</b>				
		<b>Kit for internal cable sleeves</b>				
		Mounting on the right or left-hand side inside 910 mm wide enclosures				
		Comprising: upright and mounting accessories				
		For creating a cable sleeve with a usable width of 250 mm				
1	0 204 28	For enclosure height 1550 mm, Cat.No 0 204 08/58				
1	0 204 29	For enclosure height 1950 mm, Cat.No 0 204 09/59				
		<b>Fixing devices</b>				
1	0 206 78	For DPX <sup>3</sup> 630 vertical				
1	0 206 79	For DPX <sup>3</sup> 630 vertical with earth leakage module				
		<b>Faceplates with hinges and locks</b>				
		With cut-outs for DPX <sup>3</sup> 630 with or without earth leakage module				
1	0 204 48	For internal cable sleeves height 1550 or 1595 mm				
1	0 204 49	For internal cable sleeves height 1950 or 1995 mm				

Pack	Cat.Nos	<b>Doors</b>				
		Supplied with handle, interchangeable key barrels, to be ordered separately (p. 216)				
		Distance faceplate/door:				
		- metal: 67 mm				
		- glass: 63 mm				
		<b>Curved</b>				
				For cabinet		
				Height (mm)		Width (mm)
1	0 212 53	Metal	Glass	1550		660
1	0 212 54			1950		660
1	0 212 58			1550		910
1	0 212 59			1950		910

Pack	Cat.Nos	<b>External cable sleeves</b>				
		<b>Side cable sleeves</b>				
		Can be attached on the right or left-hand side				
		Supplied with a plinth height 100 mm and joining accessories				
		Height (mm)	Faceplate height (mm)	Width (mm)		Depth (mm)
				external	usable	
1	0 204 23	1550	1400	460	400	230
1	0 204 24	1950	1800	460	400	230
		<b>Fixing devices</b>				
1	0 206 28	For DPX <sup>3</sup> 630 vertical				
1	0 206 29	For DPX <sup>3</sup> 630 vertical with earth leakage module				
		<b>Faceplates with hinges and locks</b>				
		With cut-outs for DPX 250 or 630 with or without earth leakage module				
1	0 204 43	For external cable sleeves height 1550 or 1595 mm				
1	0 204 44	For external cable sleeves height 1950 or 1995 mm				
		<b>Doors</b>				
1	0 204 33	For cable sleeves height 1550 mm				
1	0 204 34	For cable sleeves height 1950 mm				

Pack	Cat.Nos	<b>IP 43 kit</b>				
1	0 201 30	Supplied ready to use				
		Length 5.5 m for cabinets (width 660 and 910 mm), enclosures and cable sleeves				

Detailed dimensions and installation principle, **see e-catalogue**



# IP 55 distribution cabinets, cable sleeves and doors XL<sup>3</sup> 800

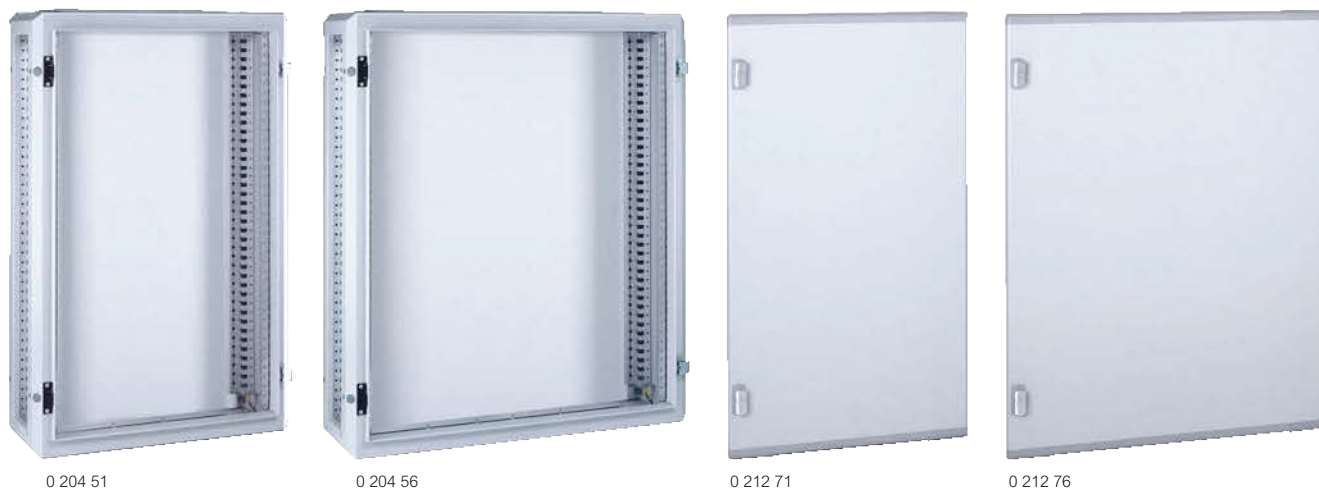

Dimensions and installation principle **see e-catalogue**

IP 55 with door IK 08  
 Metal enclosures RAL 7035, plinths RAL 7004  
 Can take devices up to 630 A  
 Fireproof to 750°C/5 s in accordance with IEC 60695-2-1  
 For installation in public buildings  
 Capacity: 24 and 36 modules per row  
 Can be joined horizontally  
 For industrial external use and urban use undershelter

Pack	Cat.Nos	Cabinets																	
		Supplied without side panels																	
		<b>Width 700 mm</b>																	
		24 modules per row																	
		<table border="1"> <thead> <tr> <th rowspan="2">Height (mm)</th> <th rowspan="2">Faceplate height (mm)</th> <th colspan="2">Width (mm)</th> <th rowspan="2">Depth (mm)</th> </tr> <tr> <th>external</th> <th>usable</th> </tr> </thead> <tbody> <tr> <td>1095</td> <td>1000</td> <td>700</td> <td>600</td> <td>225</td> </tr> <tr> <td>1295</td> <td>1200</td> <td>700</td> <td>600</td> <td>225</td> </tr> </tbody> </table>	Height (mm)	Faceplate height (mm)	Width (mm)		Depth (mm)	external	usable	1095	1000	700	600	225	1295	1200	700	600	225
Height (mm)	Faceplate height (mm)	Width (mm)			Depth (mm)														
		external	usable																
1095	1000	700	600	225															
1295	1200	700	600	225															
1	0 204 51																		
1	0 204 52																		
		<b>Width 950 mm</b>																	
		Can incorporate a cable sleeves																	
		<table border="1"> <thead> <tr> <th rowspan="2">Height (mm)</th> <th rowspan="2">Faceplate height (mm)</th> <th colspan="2">Width (mm)</th> <th rowspan="2">Depth (mm)</th> </tr> <tr> <th>external</th> <th>usable</th> </tr> </thead> <tbody> <tr> <td>1095</td> <td>1000</td> <td>950</td> <td>850</td> <td>225</td> </tr> <tr> <td>1295</td> <td>1200</td> <td>950</td> <td>850</td> <td>225</td> </tr> </tbody> </table>	Height (mm)	Faceplate height (mm)	Width (mm)		Depth (mm)	external	usable	1095	1000	950	850	225	1295	1200	950	850	225
Height (mm)	Faceplate height (mm)	Width (mm)			Depth (mm)														
		external	usable																
1095	1000	950	850	225															
1295	1200	950	850	225															
1	0 204 56																		
1	0 204 57																		
		<b>Side panels</b>																	
		Set of 2 side panels																	
		For cabinet height 1095 mm																	
1	0 204 66																		
1	0 204 67																		
		<b>Internal cable sleeves</b>																	
		<b>Kit for internal cable sleeves</b>																	
		Mounting on the right or left-hand side inside 950 mm wide cabinets																	
		Comprising : upright and mounting accessories																	
		For creating a cable sleeves with a usable width of 250 mm																	
1	0 204 26	For cabinets height 1050 or 1095 mm, Cat.No 0 204 06/56																	
1	0 204 27	For cabinets height 1250 or 1295 mm, Cat.No 0 204 07/57																	
		<b>Faceplates with hinges and locks</b>																	
1	0 204 46	For internal cable sleeves height 1050 or 1095 mm																	
1	0 204 47	For internal cable sleeves height 1250 or 1295 mm																	

Pack	Cat.Nos	Doors						
		Supplied with handle, interchangeable key barrels, to be ordered separately (p. 216)						
		Distance faceplate/door: 48 mm						
		For cabinet						
		<table border="1"> <thead> <tr> <th rowspan="2">Metal</th> <th rowspan="2">Height (mm)</th> <th rowspan="2">Width (mm)</th> </tr> </thead> <tbody> <tr> <td></td> <td></td> <td></td> </tr> </tbody> </table>	Metal	Height (mm)	Width (mm)			
Metal	Height (mm)	Width (mm)						
1	0 212 71	1095   700						
1	0 212 72	1295   700						
1	0 212 76	1095   950						
1	0 212 77	1295   950						
		<b>Accessories</b>						
1	0 205 85	Sealing kit IP 55 for use when joining cabinets together - length 2 x 10 m						
1	0 204 86 <sup>1</sup>	Joining kit						
8	0 204 82	Lifting rings						
		Set of 2						

1: For cabinets height 1095 and 1295, use 2 kits

For glass doors,  
**Please, consult us**

For detailed dimensions and installation principle, **see e-catalogue**





# IP 55 distribution enclosures, cable sleeves and doors XL<sup>3</sup> 800



Dimensions and installation principle **see e-catalogue**

IP 55 with door IK 08  
 Metal enclosures RAL 7035, plinths RAL 7004  
 Can take devices up to 630 A  
 Fireproof to 750°C/5 s in accordance with IEC 60695-2-1  
 For installation in public buildings  
 Capacity: 24 and 36 modules per row  
 Can be joined horizontally  
 For industrial external use and urban use undershelter

Pack	Cat.Nos	Enclosures																	
		Supplied with plinth height 100 mm Supplied without side panel																	
		<b>Width 700 mm</b> 24 modules per row																	
		<table border="1"> <thead> <tr> <th rowspan="2">Height (mm)</th> <th rowspan="2">Faceplate height (mm)</th> <th colspan="2">Width (mm)</th> <th rowspan="2">Depth (mm)</th> </tr> <tr> <th>external</th> <th>usable</th> </tr> </thead> <tbody> <tr> <td>1595</td> <td>1400</td> <td>700</td> <td>600</td> <td>225</td> </tr> <tr> <td>1995</td> <td>1800</td> <td>700</td> <td>600</td> <td>225</td> </tr> </tbody> </table>	Height (mm)	Faceplate height (mm)	Width (mm)		Depth (mm)	external	usable	1595	1400	700	600	225	1995	1800	700	600	225
Height (mm)	Faceplate height (mm)	Width (mm)			Depth (mm)														
		external	usable																
1595	1400	700	600	225															
1995	1800	700	600	225															
		<b>Width 950 mm</b> Can incorporate a cable sleeve 36 or 24 modules (if integrated cable sleeve)																	
		<table border="1"> <thead> <tr> <th rowspan="2">Height (mm)</th> <th rowspan="2">Faceplate height (mm)</th> <th colspan="2">Width (mm)</th> <th rowspan="2">Depth (mm)</th> </tr> <tr> <th>external</th> <th>usable</th> </tr> </thead> <tbody> <tr> <td>1595</td> <td>1400</td> <td>950</td> <td>850</td> <td>225</td> </tr> <tr> <td>1995</td> <td>1800</td> <td>950</td> <td>850</td> <td>225</td> </tr> </tbody> </table>	Height (mm)	Faceplate height (mm)	Width (mm)		Depth (mm)	external	usable	1595	1400	950	850	225	1995	1800	950	850	225
Height (mm)	Faceplate height (mm)	Width (mm)			Depth (mm)														
		external	usable																
1595	1400	950	850	225															
1995	1800	950	850	225															
		<b>Side panels</b> Set of 2 panels																	
		1 0 204 68 For enclosure height 1595 mm																	
		1 0 204 69 For enclosure height 1995 mm																	
		<b>Internal cable sleeves</b>																	
		<b>Kits for internal cable sleeves</b> Mounting on the right or left-hand side inside 950 mm wide enclosures Comprising: divider, upright and mounting accessories For creating a cable sleeves with a usable width of 250 mm																	
		1 0 204 28 For enclosure height 1550 mm, Cat.No 0 204 08/58																	
		1 0 204 29 For enclosure height 1950 mm, Cat.No 0 204 09/59																	
		<b>Fixing devices</b>																	
		1 0 206 78 For DPX <sup>3</sup> 630 vertical																	
		1 0 206 79 For DPX <sup>3</sup> 630 vertical with earth leakage module																	
		<b>Faceplates with hinges and locks</b> With cut-outs for DPX <sup>3</sup> 630 with or without earth leakage module																	
		1 0 204 48 For internal cable sleeves height 1550 or 1595 mm																	
		1 0 204 49 For internal cable sleeves height 1950 or 1995 mm																	

Pack	Cat.Nos	Doors																						
		Supplied with handle, interchangeable key barrels (to be ordered separately, p. 216) Distance faceplate/door: 48 mm																						
		For cabinet																						
		<table border="1"> <thead> <tr> <th rowspan="2">Metal</th> <th rowspan="2">Height (mm)</th> <th colspan="2">Width (mm)</th> </tr> <tr> <th>external</th> <th>usable</th> </tr> </thead> <tbody> <tr> <td>1</td> <td>0 212 73</td> <td>1595</td> <td>700</td> </tr> <tr> <td>1</td> <td>0 212 74</td> <td>1995</td> <td>700</td> </tr> <tr> <td>1</td> <td>0 212 78</td> <td>1595</td> <td>950</td> </tr> <tr> <td>1</td> <td>0 212 79</td> <td>1995</td> <td>950</td> </tr> </tbody> </table>	Metal	Height (mm)	Width (mm)		external	usable	1	0 212 73	1595	700	1	0 212 74	1995	700	1	0 212 78	1595	950	1	0 212 79	1995	950
Metal	Height (mm)	Width (mm)																						
		external	usable																					
1	0 212 73	1595	700																					
1	0 212 74	1995	700																					
1	0 212 78	1595	950																					
1	0 212 79	1995	950																					
		<b>External cable sleeves</b>																						
		<b>Side cable sleeves</b> Can be attached on the right or left-hand side Supplied without side panels with a plinth height 100 mm																						
		<table border="1"> <thead> <tr> <th rowspan="2">Height (mm)</th> <th rowspan="2">Faceplate height (mm)</th> <th colspan="2">Width (mm)</th> <th rowspan="2">Depth (mm)</th> </tr> <tr> <th>external</th> <th>usable</th> </tr> </thead> <tbody> <tr> <td>1</td> <td>0 204 73</td> <td>1595</td> <td>400</td> <td>225</td> </tr> <tr> <td>1</td> <td>0 204 74</td> <td>1995</td> <td>400</td> <td>225</td> </tr> </tbody> </table>	Height (mm)	Faceplate height (mm)	Width (mm)		Depth (mm)	external	usable	1	0 204 73	1595	400	225	1	0 204 74	1995	400	225					
Height (mm)	Faceplate height (mm)	Width (mm)			Depth (mm)																			
		external	usable																					
1	0 204 73	1595	400	225																				
1	0 204 74	1995	400	225																				
		<b>Fixing devices</b>																						
		1 0 206 28 For DPX <sup>3</sup> 630 vertical																						
		1 0 206 29 For DPX <sup>3</sup> 630 vertical with earth leakage module																						
		<b>Faceplates with hinges and locks</b> With cut-outs for DPX <sup>3</sup> 630 with or without earth leakage module																						
		1 0 204 43 For internal cable sleeve height 1550 or 1595 mm																						
		1 0 204 44 For internal cable sleeve height 1950 or 1995 mm																						
		<b>Doors</b>																						
		1 0 204 83 For external cable sleeve height 1400 mm																						
		1 0 204 84 For external cable sleeve height 1800 mm																						
		<b>Accessories</b>																						
		1 0 205 85 Sealing kit IP 55 for use when joining cabinets together - length 2 x 10 m																						
		1 0 204 86 <sup>1</sup> Joining kit																						
		8 0 204 82 Lifting rings Set of 2																						

1: For enclosures height 1595, use 3 kits  
 For enclosures height 1995, use 4 kits





# With XL<sup>3</sup> Calcul you can...

.... design the wiring diagram,  
automatically calculate total power  
consumption, required protection  
devices and cable section for each  
circuit.

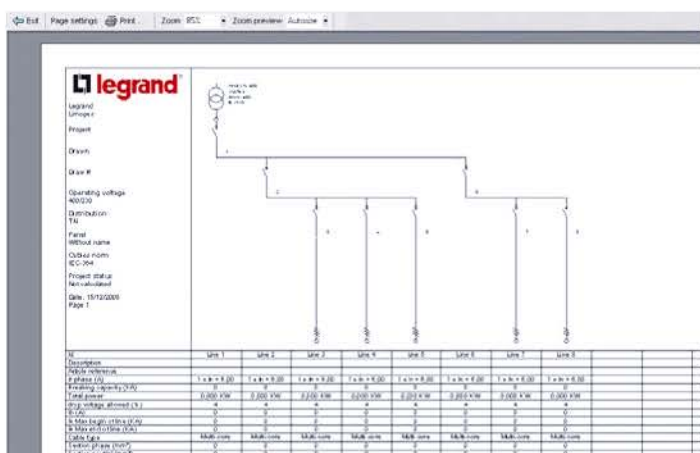

## MAIN BENEFITS

- Easily edit all required technical documents
- Use the Legrand products which are the most suitable for your installation
- Benefit from the permanent free updates
- Export all the XLPro<sup>3</sup> Calcul data into XLPro<sup>3</sup> without re-entering it

## MORE INFORMATION



Get detailed information on many digital or printed supports on [www.export.legrand.com](http://www.export.legrand.com) or contact your Area Commercial Manager in order to obtain your XLPro<sup>3</sup> Calcul software.

## Accessories for XL<sup>3</sup> 800

cables fixing, plinths, dividers and accessories



0 204 36



0 201 95

Pack	Cat.Nos	Cable fixing supports
1	0 204 35	For 660 mm wide cabinets
1	0 204 36	For 910 mm wide cabinets
1	0 204 37	For horizontal external cable sleeves
<b>Plinths</b>		
<b>For IP 43 enclosures</b>		
1	0 204 10	Width: 660 mm
1	0 204 11	Width: 910 mm
1	0 204 12	For cable sleeves width: 460 mm
<b>For IP 55 enclosures</b>		
1	0 204 60	Width: 700 mm
1	0 204 61	Width: 950 mm
1	0 204 62	For cable sleeves, width: 500 mm
<b>Dividers for horizontal compartments</b>		
1	0 204 90	For cabinets and enclosures, usable width: 600 mm
1	0 204 91	For cabinets and enclosures, usable width: 850 mm
<b>Accessories</b>		
<b>Wall mounting lugs</b>		
1	0 201 00	Set of 4 metal lugs for IP 43 cabinets and enclosures
<b>Universal supports</b>		
For mounting terminal blocks, earth terminals, etc. Set of 3 metal supports		
1	0 201 96	For internal cable sleeves
1	0 201 95	For external cable sleeves
<b>Cable entry plate</b>		
1	0 204 20	Additional adjustable plate for XL3 800 - IP 43
<b>Key barrels</b>		
Supplied with a set of 2 keys		
1	0 202 91	Type 405
1	0 202 92	Type 455
1	0 202 93	Type 1242E
1	0 202 94	Type 2433A
1	0 202 96	Double bar knockout

## Equipment for XL<sup>3</sup> 800

for modular devices, Vistop, DPX<sup>3</sup> 160/250, DPX-IS 250 on rail



0 206 01



0 208 00



0 209 01

Pack	Cat.Nos	Fixing on rail
1	24 modules   36 modules 0 206 01   0 206 51	<b>Rails </b> Comprising: an aluminium profile rail and two 2-position fixing brackets Fit onto functional uprights Accept HX <sup>3</sup> 125 A plug-in connection row distribution blocks For mounting DPX <sup>3</sup> using fixing plates for fixing XL <sup>3</sup> 800 and XL <sup>3</sup> 4000 functional uprights Accept wire guide Cat.No 4 052 25 (p. 209)
1	<b>N</b> 4 210 71	<b>Fixing plates for mounting DPX<sup>3</sup> 160/250 on rail </b> For mounting DPX <sup>3</sup> 160/250 on aluminium rail  and on plate Cat.Nos 0 206 11/61 For DPX <sup>3</sup> 160 without side motor-driven handle
1	4 210 73	For DPX <sup>3</sup> 160 with earth leakage module without side motor-driven handle
1	4 210 68	For all DPX <sup>3</sup> 160 devices with side motor-driven handle
1	4 210 72	For DPX <sup>3</sup> 250 without side motor-driven handle
1	4 210 74	For DPX <sup>3</sup> 250 with earth leakage module without side motor-driven handle
1	4 210 69	For all DPX <sup>3</sup> 250 devices with side motor-driven handle
1	0 262 39	<b>Fixing plate for mounting DPX-IS 250 on rail </b> For mounting devices on aluminium rail  and on plate Cat.Nos 0 206 11/61 For DPX-IS 250
1	4 052 26	<b>Rail height spacer</b> Designed for simultaneous mounting of modular devices and DPX <sup>3</sup> 160/250 and DPX-IS 250 devices mounted on rail  Cat.Nos 0 206 01/51 or plate Cat.Nos 0 206 11/61 For 20 modules

Pack	Cat.Nos	Metal faceplates
1	24 modules   36 modules 0 208 00 <sup>1</sup>   0 209 50 <sup>2</sup>	<b>For modular devices</b> 1/4 turn With captive screws
1	0 208 01 <sup>1</sup>   0 209 51 <sup>2</sup>	<b>For Vistop up to 160 A</b> 1/4 turn With captive screws
1	0 208 10 <sup>1</sup>   0 209 10 <sup>2</sup>	<b>For DPX<sup>3</sup> 160/250 and DPX-IS 250</b> 1/4 turn With captive screws

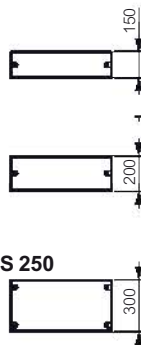

1: For fastening and sealing  
2: Hinges Cat.No 0 209 59 available as an option

## Equipment for XL<sup>3</sup> 800

for mounting on plate: DPX-IS 250, DPX-IS 630, DPX-IS 1600



0 206 05



0 208 10

0 209 10

Pack	Cat.Nos	Plates for DPX-IS
1	24 modules   36 modules 0 206 05   0 206 55	Direct fixing on functional uprights <b>Fixed plates - front and rear terminals</b> For 1 or 2 DPX-IS 250 in vertical position For 1 DPX-IS 630 in vertical position For 1 DPX-IS 1600 or 1 DPX 1600 front terminals For 1 DPX-IS 630 in external cable sleeve
1	0 206 07   0 206 57	
1	0 211 00	
1	Cable sleeve 0 206 27	
1	24 modules   36 modules 0 208 10 <sup>1</sup>   0 209 60 <sup>2</sup>	<b>Metal faceplates</b> <b>For DPX-IS 250 in central position</b> 1/4 turn With captive screws
1	0 209 10 <sup>2</sup>	
1	0 208 06 <sup>1</sup>   0 209 60 <sup>2</sup>	<b>For 2 DPX-IS 250</b> 1/4 turn With captive screws
1	0 209 06 <sup>2</sup>	
1	0 208 07 <sup>1</sup>   0 209 57 <sup>2</sup>	<b>For 1 DPX-IS 630</b> 1/4 turn With captive screws Does not allow the use of terminal shields Cat.No 0 262 45
1	0 209 07 <sup>2</sup>	
1	24 modules 0 211 13 <sup>2</sup>	<b>For 1 DPX-IS 1600 in vertical position</b> With captive screws

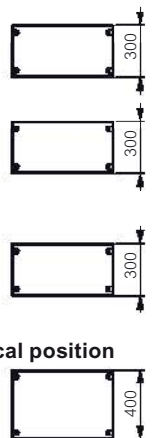

1: For fastening and sealing  
2: Hinges Cat.No 0 209 59 available as an option

For installation principle, see e-catalogue



## Equipment for XL<sup>3</sup> 800

for mounting on plate: DPX<sup>3</sup> 160 and DPX<sup>3</sup> 250



## Equipment for XL<sup>3</sup> 800

for mounting on plate: DPX<sup>3</sup> 250, DPX<sup>3</sup> 630 and DPX<sup>3</sup> 1600



0 206 11



0 206 17



0 208 13



0 206 20

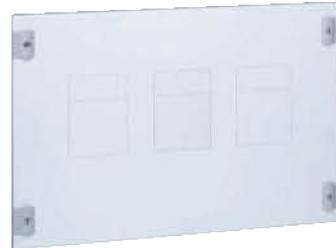

0 208 20

### Plates for fixed version DPX<sup>3</sup> 160/250 with front terminals

Pack.	Cat.Nos	
1	24 modules 0 206 11	36 modules 0 206 61
1	0 206 08	
1	0 206 13	
1	24 modules 0 206 15	
1	0 206 17	

Direct fixing on functional uprights

**Devices in vertical position**

Equipped with a rail for fixing DPX<sup>3</sup> 160/250  
The DPX<sup>3</sup> must be equipped with a fixing plate Cat.Nos 4 210 68/69/71/72/73/74 or plate for manual supply inverter Cat.No 4 210 58  
Designed for simultaneous mounting of DPX<sup>3</sup> 160/250 and modular equipment (with spacer Cat.No 0 262 99)

Plate for DPX<sup>3</sup> with direct rotary handle  
The DPX<sup>3</sup> must be equipped with a fixing plate Cat.Nos 4 210 68/69

Plate for motor-driven supply inverter  
The DPX<sup>3</sup> must be equipped with a fixing plate Cat.No 4 210 58

**Devices in horizontal position**

For cut-out protection for cable passing, use seal Cat.No 0 202 40  
For 1 DPX<sup>3</sup> 160  
For 1 DPX<sup>3</sup> 250

### Metal faceplates

1	24 modules 0 208 10 <sup>1</sup>	36 modules 0 209 60 <sup>2</sup>	
1	0 209 10 <sup>2</sup>	0 209 60 <sup>2</sup>	
1	0 209 27		
1	24 modules 0 208 05 <sup>1</sup>		
1	0 209 05 <sup>2</sup>		
1	0 208 13 <sup>1</sup>		
1	0 209 13 <sup>2</sup>		
1	0 208 17 <sup>1</sup>		
1	0 209 17 <sup>2</sup>		

1: For fastening and sealing  
2: Hinges Cat.No 0 209 59 available as an option

### Installation principle see e-catalogue

Pack	Cat.Nos	
1	24 modules 0 206 20	36 modules 0 206 70
1	0 206 22	0 206 72
1	0 211 00	0 211 02
1	0 206 23	
1	0 211 00	0 211 02
1	24 modules 0 208 20 <sup>1</sup>	36 modules 0 209 70 <sup>2</sup>
1	0 209 20 <sup>2</sup>	0 209 72 <sup>2</sup>
1	0 208 22 <sup>1</sup>	
1	0 209 22 <sup>2</sup>	0 209 72 <sup>2</sup>
	0 211 13 <sup>1</sup>	
1	0 211 10 <sup>1</sup>	
1	0 211 11 <sup>2</sup>	0 211 12 <sup>2</sup>
1	0 208 23 <sup>1</sup>	
1	0 209 23 <sup>2</sup>	
1	24 modules 0 208 34 <sup>1</sup>	36 modules 0 209 84 <sup>2</sup>
1	0 209 34 <sup>2</sup>	0 209 84 <sup>2</sup>

Direct fixing on functional uprights

**Devices in vertical position**

For 1 to 3 DPX<sup>3</sup> 630  
For 1 to 3 DPX<sup>3</sup> 630 with earth leakage module  
For 1 DPX-IS 1600 or 1 DPX<sup>3</sup> 1600 front terminal

**Devices in horizontal position**

For cut-out protection for cable passing, use seal Cat.No 0 202 40  
For 1 DPX<sup>3</sup> 630 with or without earth leakage module  
For 1 DPX-IS 1600 or 1 DPX<sup>3</sup> 1600 front terminal

**Metal faceplates - devices in vertical position**

**For 1 to 3 DPX<sup>3</sup> 630 only**  
1/4 turn  
With captive screws

**For 1 to 3 DPX<sup>3</sup> 630 with downstream earth leakage module**  
1/4 turn  
With captive screws

**For 1 DPX-IS 1600**  
With captive screws

**For 1 DPX<sup>3</sup> 1600**  
1/4 turn<sup>(1)</sup>  
With captive screws

**Metal faceplates - devices in horizontal position**

**For 1 DPX<sup>3</sup> 630 with or without earth leakage module**  
1/4 turn  
With captive screws

**For 1 DPX<sup>3</sup> 1600**  
1/4 turn  
With captive screws

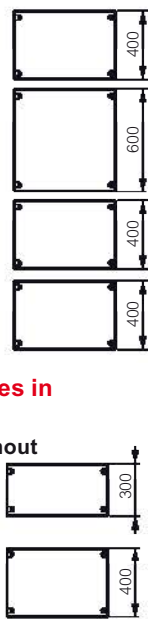

1: For fastening and sealing  
2: Hinges Cat.No 0 209 59 available as an option

## Accessories and faceplates XL<sup>3</sup> 800



Pack	Cat.Nos	Universal plates
		Fit onto functional uprights
1	0 206 41	<b>Perforated width 600 mm</b>
1	0 206 42	Height 200 mm
		Height 400 mm
		<b>Solid plates width 600 mm</b>
1	0 206 43	Height 200 mm
1	0 206 44	Height 400 mm
1	0 206 45	Height 600 mm
		<b>Solid plates width 850 mm</b>
1	0 206 46	Height 400 mm
		<b>Universal rails</b>
		Fit onto functional uprights
1	0 206 04	Width 600 mm (24 modules)
1	0 206 54	Width 850 mm (36 modules)
		<b>Adjustable universal fixing devices</b>
		Comprising a rail 2 and 2 adjustable fixing brackets
		Fit onto functional uprights
1	0 206 02	For 24 modules cabinets and enclosures
1	0 206 52	For 36 modules cabinets and enclosures
		<b>Accessories</b>
		<b>Clip nuts and screws</b>
		1/4 fastening on front panel
20	0 200 92	Clip nuts for M6 screws
50	0 200 91	M6 screws
		<b>Aerosol paint spray</b>
6	0 200 98	RAL 7035 - 400 ml
		<b>Lighting for panel</b>
		<b>Lighting kit</b>
1	0 209 89	Kit for metal XL <sup>3</sup> 800/4000, comprising fluorescent lamp, fixings and metal screw-mounting faceplate
		<b>Wiring</b>
		<b>Lina 25 ducting mounting supports</b>
		For horizontal and vertical mounting and height adjustment of Lina 25 ducting
		Supplied with plastic rivets
1	0 204 70	Set of 2, for 36 modules cabinets and enclosures
1	0 205 70	Set of 2, for 24 modules cabinets and enclosure
		<b>Lina 25 ducting</b>
		Length: 2 m
		Width (mm)   Height (mm)
56	0 362 02	25   60
48	0 362 07	40   60
40	0 362 08	40   80
32	0 362 12	60   60
32	0 362 13	60   80
		<b>Plastic rivet</b>
100	0 200 80	For fixing Lina 25 ducting on functional uprights

Pack	Cat.Nos	Solid metal faceplates
		<b>1/4 turn</b>
		For fastening and sealing
		Height (mm)
	24 modules	
1	0 208 40	50
1	0 208 41	100
1	0 208 42	150
1	0 208 43	200
1	0 208 44	300
1	0 208 45	400
1	0 208 46	600
		<b>Captive screws</b>
		Hinges Cat.No 0 209 59 available as an option
		Height (mm)
	24 modules   36 modules	
1	0 209 40   0 209 90	50
1	0 209 41   0 209 91	100
1	0 209 42   0 209 92	150
1	0 209 43   0 209 93	200
1	0 209 44   0 209 94	300
1	0 209 45   0 209 95	400
1	0 209 46   0 209 96	600
		<b>Hinges</b>
1	0 209 59	Set of 2 hinges
		Fit on screw mounting faceplates
		<b>Blanking plates</b>
		For metal or plastic faceplates
20	0 200 51	24 modules, smooth adjustable strip
10	0 016 65	18 modules, separable into module or 1/2 module
		<b>Clip-on holder for adhesive labels</b>
		Supplied with a sheet of labels for marking rows on faceplate
10	0 203 99	24 modules
		<b>Accessories for natural ventilation</b>
		Assist natural ventilation
		Screw mounting
1	24 modules	Height 200 mm
	0 209 49	



# Enclosures for any configuration

XL<sup>3</sup> 4000 enclosures are fully modular, enable different configurations (back to back, or side by side) and take all equipment up to 4000 A, whatever level of partitioning is required



XL<sup>3</sup> 4000 enclosure with Legrand protection devices

### DISCOVER THE RANGE

- Enclosure:
  - 2 Heights: 2 m and 2.2 m
  - 3 Widths: 475, 725 or 975 mm
  - 3 Depths: 475, 725 or 975 mm
  - IP 30 or IP 55 (with door and seal)
- Takes: DIN rail equipment, DMX<sup>3</sup>, DPX<sup>3</sup>, DPX-IS and Vistop up to 4000 A

### FROM IEC 60439 TO IEC 61439



XL<sup>3</sup> configurable assemblies guide to migration from IEC 60439 to IEC 61439  
**Download the guide on**  
[www.docexport.legrand.com](http://www.docexport.legrand.com)

Device	Version	Position	Configuration	Connection terminals
<b>FIXING ON DIN-RAIL</b>				
DX <sup>3</sup> < 63 A		vertical		
DX <sup>3</sup> > 63 A		vertical		
Vistop 63 to 160 A	modular	vertical		
DPX-IS 250	fixed	vertical	with modular devices	front or rear
<b>FIXING ON PLATE</b>				
DPX <sup>3</sup> 160 (Combination possible with DPX <sup>3</sup> 250)	fixed	vertical	without side motor-driven handle	front
			with side motor-driven handle	front
			without front motor-driven handle	front or rear
			with front motor-driven handle	front or rear
			with direct rotary handle	front
				front or rear
			manual supply inverter	front
		front or rear		
		motor-driven supply inverter	front	
			front or rear	
			front	
		horizontal	-	front
			with or without front motor-driven handle	front or rear
	draw-out	vertical	with or without front motor-driven handle	front or rear
with direct rotary handle			front or rear	
manual or motor-driven supply inverter			front or rear	
horizontal		with or without front motor-driven handle	front or rear	
DPX <sup>3</sup> 250 (Combination possible with thermal-magnetic DPX <sup>3</sup> 160)	fixed	vertical	without side motor-driven handle	front
			with side motor-driven handle	front
			without front motor-driven handle	front or rear
			with front motor-driven handle	front or rear
			with direct rotary handle	front
				front or rear
			manual supply inverter	front
		front or rear		
		motor-driven supply inverter	front	
			front or rear	
			front	
		horizontal	-	front
			with or without front motor-driven handle	front or rear
	draw-out	vertical	with or without front motor-driven handle	front or rear
with direct rotary handle			front or rear	
manual or motor-driven supply inverter			front or rear	
horizontal		with or without front motor-driven handle	front or rear	
DPX-IS 250	fixed	vertical	centred device only	front or rear
			1 or 2 devices	front or rear
		horizontal	1 device	front or rear

1: Cat.Nos 4 210 73/74 for DPX<sup>3</sup> with earth leakage module

	XL <sup>3</sup> 4000 - 24 modules							XL <sup>3</sup> 4000 - 36 modules			
	Spacer	Fixing devices	Plate	Height (mm)	Metal faceplate			Fixing devices	Plate	Metal faceplate	
					1/4 turn	Screw	Lock			Height (mm)	Screw
		0 206 01	-	150	0 208 00	0 209 00	-	0 206 51	-	150	0 209 50
		0 206 01	-	200	0 208 01	0 209 01	0 212 09	0 206 51	-	200	0 209 51
		0 206 01	-	200	0 208 01	0 209 01	0 212 09	0 206 51	-	200	0 209 51
		0 206 01	0 262 39	300	0 208 10	0 209 10	-	0 206 51	0 262 39	300	0 209 60
	-	-	0 206 11 + 4 210 71/73 <sup>(1)</sup>	300	0 208 10	0 209 10	-	-	0 206 61 + 4 210 71/73 <sup>(1)</sup>	300	0 209 60
	-	-	0 206 11 + 4 210 68	300	0 208 10	0 209 10	-	-	0 206 61 + 4 210 68	300	0 209 60
	0 207 50	0 207 90	0 207 49	300	0 208 10	0 209 10	-	0 207 61	0 207 49	300	0 209 60
	-	0 207 90	0 207 49	300	0 208 10	0 209 10	-	0 207 61	0 207 49	300	0 209 60
	-	-	0 206 08 + 4 210 71/73 <sup>(1)</sup>	300	0 208 05	0 209 05	-	-	-	-	-
	0 207 50	0 207 90	0 207 49	300	0 208 05	0 209 05	-	0 207 61	0 207 49	300	0 209 65
	-	-	0 206 11 + 4 210 58	300	0 208 10	0 209 10	-	-	-	-	-
	0 207 50	0 206 63	0 206 71	300	0 208 10	0 209 10	-	-	-	-	-
	-	-	0 206 13 + 4 210 58	300	0 208 10	0 209 10	-	-	-	-	-
	-	0 206 63	0 206 71	300	0 208 10	0 209 10	-	-	-	-	-
	-	-	0 206 15	150	0 208 13	0 209 13	-	-	-	-	-
	-	-	0 207 94	150	0 208 13	0 209 13	-	-	-	-	-
	0 207 50	0 207 91	0 207 59	400	-	-	0 212 11	-	-	-	-
	-	0 207 91	0 207 59	400	-	-	0 212 08	-	-	-	-
	0 207 50	0 206 69	0 206 81	400	-	-	0 212 11	-	-	-	-
	-	-	0 207 95	200	-	-	0 212 13	-	-	-	-
	-	-	0 206 11 + 4 210 72/74 <sup>(1)</sup>	300	0 208 10	0 209 10	-	-	0 206 61 + 4 210 72/74 <sup>(1)</sup>	300	0 209 60
	-	-	0 206 11 + 4 210 69	300	0 208 10	0 209 10	-	-	0 206 61 + 4 210 69	300	0 209 60
	-	0 207 90	0 207 64	300	0 208 10	0 209 10	-	0 207 61	0 207 49	300	0 209 60
	0 207 50	0 207 90	0 207 64	300	0 208 10	0 209 10	-	0 207 61	0 207 49	300	0 209 60
	0 207 50	-	0 206 08 + 4 210 72/74 <sup>(1)</sup>	300	0 208 05	0 209 05	-	-	-	-	-
	0 207 50	0 207 90	0 207 64	300	0 208 05	0 209 05	-	0 207 61	0 207 49	300	0 209 65
	-	-	0 206 11 + 4 210 58	300	0 208 10	0 209 10	-	-	-	-	-
	0 207 50	0 206 63	0 206 73	300	0 208 10	0 209 10	-	-	-	-	-
	-	-	0 206 13 + 4 210 58	300	0 208 10	0 209 10	-	-	-	-	-
	-	0 206 63	0 206 73	300	0 208 10	0 209 10	-	-	-	-	-
	-	-	0 206 17	200	0 208 17	0 209 17	-	-	-	-	-
	-	-	0 207 96	200	0 208 17	0 209 17	-	-	-	-	-
	0 207 50	0 207 91	0 207 69	400	-	-	0 212 11	-	-	-	-
	-	0 207 91	0 207 69	400	-	-	0 212 08	-	-	-	-
	0 207 50	0 206 69	0 206 83	400	-	-	0 212 11	-	-	-	-
	-	-	0 207 97	200	-	-	0 212 13	-	-	-	-
	-	-	0 206 05	300	0 208 10	0 209 10	-	-	0 206 55	300	0 209 60
	-	-	0 206 05	300	0 208 06	0 209 06	-	-	0 206 55	300	0 209 60
	-	-	0 206 18	300	-	0 209 18	-	-	-	-	-

## Equipment selection for XL<sup>3</sup> 4000

Device	Version	Position	Configuration	Connection (terminals)	Rotary handle/ motor-driven	
<b>FIXING ON PLATE</b>						
<b>DPX<sup>3</sup> 630</b>	fixed	vertical	1 to 3 devices, no elcbs	front	-	
			1 to 3 devices, no elcbs	front or rear	with or without	
			1 to 3 devices, with elcbs	front	-	
			1 to 3 devices, with elcbs	front or rear	with or without	
		horizontal	with or without elcbs	front	-	
			with or without elcbs	front or rear	with or without	
	vertical	supply inverters	front or rear	with or without mot. control		
		plug-in	vertical	1 to 2 devices, no elcbs	front or rear	with or without
	draw-out		vertical	no elcbs	front or rear	with or without rotary handle
		no elcbs		front or rear	motor-driven	
		with elcbs		front or rear	with or without rotary handle	
		horizontal	with or without elcbs	front or rear	with or without rotary handle	
			with or without elcbs	front or rear	motor-driven	
		vertical	supply inverters	front or rear	motor-driven	
<b>DPX-IS 630</b>	fixed	vertical	device only	front or rear	-	
		horizontal	device only	front or rear	-	
<b>DPX-IS 1600</b>	fixed	vertical	device only	front terminals	-	
			device only	rear terminals	-	
		horizontal	device only	-	-	
<b>DPX<sup>3</sup> 1600</b>	fixed	vertical	no elcbs	front terminals	-	
			no elcbs	front terminals	rotary handle or motor-driven	
			no elcbs	rear terminals	-	
			no elcbs	rear terminals	rotary handle or motor-driven	
		horizontal	no elcbs	front terminals	-	
			no elcbs	front terminals	motor-driven	
			no elcbs	rear terminals	motor-driven	
			no elcbs	front or rear	-	
			no elcbs	front or rear	rotary handle or motor-driven	
			supply inverters	front or rear	-	
	draw-out	vertical	no elcbs	front terminals	-	
			no elcbs	front terminals	rotary handle or motor-driven	
		horizontal	no elcbs	rear terminals	-	
			supply inverters	rear terminals	motor-driven	
<b>DMX<sup>3</sup> 2500, N/H/L, 3P</b> <b>DMX<sup>3</sup> 2500, N/H, 4P</b>	fixed	vertical	device only	rear terminals	-	
	draw-out	vertical	device only	rear terminals	-	
<b>DMX<sup>3</sup>-L 2500 4P</b>	fixed	vertical	device only	rear terminals	-	
	draw-out	vertical	device only	rear terminals	-	
<b>DMX<sup>3</sup> 4000, N/H/L, 3P</b>	fixed	vertical	device only	rear terminals	-	
	draw-out	vertical	device only	rear terminals	-	
<b>DMX<sup>3</sup>-L 4000, N/H/L, 4P</b>	fixed	vertical	device only	rear terminals	-	
	draw-out	vertical	device only	rear terminals	-	

1: No height spacer if motor-driven  
2: Two sets of spacers for adjustable plate



	XL <sup>3</sup> 4000 - 24 modules							XL <sup>3</sup> 4000 - 36 modules				
	Spacer	Fixing devices	Plate	Height (mm)	Metal faceplate		Lock	Fixing devices	Plate	Height (mm)	Metal faceplate	
					1/4 turn	Screw					Screw	Lock
		-	0 206 20	400	0 208 20	0 209 20	-	-	0 206 70	400	0 209 70	-
	0 207 50 <sup>(1)</sup>	0 207 20	0 207 85	400	0 208 20	0 209 20	-	0 207 70	0 207 85	400	0 209 70	-
		-	0 206 22	600	0 208 22	0 209 22	-	-	0 206 72	600	0 209 72	-
	0 207 50 <sup>(1)</sup>	0 207 22	0 207 86	600	0 208 22	0 209 22	-	0 207 72	0 207 86	600	0 209 72	-
		-	0 206 23	300	0 208 23	0 209 21	-	-	-	-	-	-
		-	0 207 93	300	-	0 209 23	-	-	-	-	-	-
	0 207 50 <sup>(1)</sup>	-	0 206 76	400	-	0 209 76	-	-	-	-	-	-
		0 207 21	0 207 87	400	-	-	0 212 20	-	-	-	-	-
		-	0 207 98	300	-	-	0 212 17	-	-	-	-	-
	0 207 50	0 207 21	0 207 87	400	-	-	0 212 21	-	-	-	-	-
	0 207 50	0 207 21	0 207 87	400	-	-	0 212 04	-	-	-	-	-
	0 207 50	0 207 23	0 207 88	600	-	-	0 212 23	-	-	-	-	-
		-	0 207 98	300	-	-	0 212 18	-	-	-	-	-
		-	0 207 98	300	-	-	0 212 19	-	-	-	-	-
	0 207 50	-	0 206 76	400	-	-	0 212 95	-	-	-	-	-
		-	0 206 07	300	0 208 07	0 209 07	-	-	0 206 57	300	0 209 57	-
			0 206 19	300	-	0 209 19	-	-	-	-	-	-
		-	0 211 00	400	-	0 211 13	-	-	-	-	-	-
		-	0 211 06	400	-	0 211 13	-	-	-	-	-	-
		-	0 211 00	400	-	0 208 36	-	-	-	-	-	-
		-	0 211 00	400	0 211 10	0 211 11	-	-	0 211 02	400	0 211 12	-
	0 207 50 <sup>(1)(2)</sup>	-	0 211 04	400	-	0 211 14	-	-	-	-	-	-
	0 207 50 <sup>(1)(2)</sup>	-	0 211 06	400	0 211 10	0 211 11	-	-	0 211 03	400	0 211 12	-
	0 207 50 <sup>(1)(2)</sup>	-	0 211 06	400	-	0 211 14	-	-	-	-	-	-
		-	0 211 00	400	0 208 34	0 209 34	-	-	0 206 80	400	0 209 84	-
		-	0 211 00	400	-	0 209 36	-	-	-	-	-	-
		-	0 211 00	400	-	0 209 35	-	-	-	-	-	-
	0 207 50 <sup>(1)(2)</sup>	-	0 207 36	400	0 208 34	0 209 34	-	-	-	-	-	-
	0 207 50 <sup>(1)(2)</sup>	-	0 207 36	400	-	0 209 35	-	-	-	-	-	-
		-	0 206 86	800	-	0 209 86	-	-	-	-	-	-
		-	0 206 86	800	-	0 209 87	-	-	-	-	-	-
		-	0 211 05	400	-	-	0 211 15	-	-	-	-	-
		-	0 211 05	400	-	-	0 211 16	-	-	-	-	-
		-	0 207 35	400	-	-	0 212 34	-	-	-	-	-
		-	0 207 35	400	-	-	0 212 35	-	-	-	-	-
		-	0 206 87	800	-	-	0 212 37	-	-	-	-	-
		0 207 51	-	600	-	-	0 209 38	0 207 52	-	600	-	0 209 48
		0 207 53	-	600	-	-	0 209 38	0 207 54	-	600	-	0 209 48
		0 207 51	-	600	-	-	0 209 39	0 207 52	-	600	-	0 209 48
		0 207 53	-	600	-	-	0 209 39	0 207 54	-	600	-	0 209 48
		0 207 51	-	600	-	-	0 209 38	0 207 52	-	600	-	0 209 48
		0 207 53	-	600	-	-	0 209 38	0 207 54	-	600	-	0 209 48
		0 207 51	-	600	-	-	0 209 39	0 207 52	-	600	-	0 209 48
		0 207 53	-	600	-	-	0 209 39	0 207 54	-	600	-	0 209 48

# Distribution enclosures XL<sup>3</sup> 4000



Assembly consisting of:  
 - Structural upright Cat.Nos 0 205 00  
 - "Roof-base" Cat.Nos 0 205 03/06/09  
 - Plinth Cat.Nos 0 205 17/18/19  
 - Functional uprights Cat.Nos 0 205 24/27  
 - Intermediate structural uprights Cat.No 0 205 20



0 205 12

Dimensions and installation principle **see e-catalogue**  
 Composition table **p. 226**

IP 30 - IK 07  
 IP 55 - IK 08 with door and sealing kit for use when joining enclosures  
 Consist of the combination of a "roof-base" assembly, structural uprights, functional uprights, rear and side panels RAL 7035, plinths RAL 7004  
 Height 2000 or 2200 mm.  
 Capacity 24 modules (enclosures width 725 or width 975 with internal cable sleeve), 36 modules (enclosures width 975)  
 Usable faceplate height 1800 mm (1700 mm only if using the pivoting support frame) or 2000 mm

Pack	Cat.Nos	Enclosures and cable sleeves modular metal																								
1	0 205 00   0 208 50	<b>Structural uprights</b> Fit onto the "roof-base" assembly Take the side and rear panels Set of 4 uprights																								
		<b>Intermediate structural upright</b> Fits on the structure of the enclosure "roof-base"																								
1	0 205 20   0 208 51	<b>"Roof-base" for enclosure</b> Fitted with cable entry plates Take the structural uprights																								
		<table border="1"> <thead> <tr> <th rowspan="2">Depth (mm)</th> <th colspan="2">Width (mm)</th> </tr> <tr> <th>external</th> <th>usable</th> </tr> </thead> <tbody> <tr> <td>475</td> <td>725</td> <td>600</td> </tr> <tr> <td>725</td> <td>725</td> <td>600</td> </tr> <tr> <td>475</td> <td>975</td> <td>850</td> </tr> <tr> <td>725</td> <td>975</td> <td>850</td> </tr> <tr> <td>975</td> <td>725</td> <td>600</td> </tr> <tr> <td>975</td> <td>975</td> <td>850</td> </tr> </tbody> </table>	Depth (mm)	Width (mm)		external	usable	475	725	600	725	725	600	475	975	850	725	975	850	975	725	600	975	975	850	
Depth (mm)	Width (mm)																									
	external	usable																								
475	725	600																								
725	725	600																								
475	975	850																								
725	975	850																								
975	725	600																								
975	975	850																								
1	0 205 04   0 208 51	<b>"Roof-base" for cable sleeves</b> Fitted with cable entry plates Take the structural uprights																								
		<table border="1"> <thead> <tr> <th rowspan="2">Depth (mm)</th> <th colspan="2">Width (mm)</th> </tr> <tr> <th>external</th> <th>usable</th> </tr> </thead> <tbody> <tr> <td>475</td> <td>475</td> <td>350</td> </tr> <tr> <td>925</td> <td>475</td> <td>350</td> </tr> <tr> <td>975</td> <td>475</td> <td>350</td> </tr> </tbody> </table>	Depth (mm)	Width (mm)		external	usable	475	475	350	925	475	350	975	475	350										
Depth (mm)	Width (mm)																									
	external	usable																								
475	475	350																								
925	475	350																								
975	475	350																								
1	0 205 01   0 208 51	<b>Rear and side panels</b> Fixed with screws Width 475 mm																								
		0 205 02   0 208 51 Width 725 mm																								
		0 205 03   0 208 51 Width 975 mm																								
1	0 205 61   0 208 51	<b>Finishing panels IP 30</b> IP 30 width 475 mm																								
		0 205 62   0 208 51 IP 30 width 725 mm																								
		0 205 63   0 208 51 IP 30 width 975 mm																								
1	0 205 41   0 208 57	<b>IP 55 strip</b> IP 55 strip (for use when joining enclosures)																								
		<b>Plinths that can be placed side by side</b>																								
1	0 205 11   0 208 57	<table border="1"> <thead> <tr> <th>Height (mm)</th> <th>Width (mm)</th> <th>Depth (mm)</th> </tr> </thead> <tbody> <tr> <td>100</td> <td>475</td> <td>475</td> </tr> <tr> <td>100</td> <td>725</td> <td>475</td> </tr> <tr> <td>100</td> <td>725</td> <td>725</td> </tr> <tr> <td>100</td> <td>975</td> <td>475</td> </tr> <tr> <td>100</td> <td>975</td> <td>725</td> </tr> <tr> <td>100</td> <td>975</td> <td>725</td> </tr> <tr> <td>100</td> <td>975</td> <td>975</td> </tr> </tbody> </table>	Height (mm)	Width (mm)	Depth (mm)	100	475	475	100	725	475	100	725	725	100	975	475	100	975	725	100	975	725	100	975	975
		Height (mm)	Width (mm)	Depth (mm)																						
		100	475	475																						
		100	725	475																						
		100	725	725																						
		100	975	475																						
		100	975	725																						
		100	975	725																						
100	975	975																								

Pack	Cat.Nos	Equipment
1	0 205 12   0 208 52	<b>Functional uprights</b> Set of 2 functional uprights For fixing mounting equipment (faceplate, rails...) Reduced functional uprights for enclosure depth 475 mm
		0 205 13   0 208 53 For enclosure without internal cable sleeve
1	0 205 16   0 208 54	0 205 16   0 208 54 For enclosure with cable sleeve
		<b>Support frame for faceplates</b> Fixed for enclosure width 725 mm or enclosure width 975 mm without internal cable sleeves
1	0 205 58   0 208 55	0 205 58   0 208 55 Fixed for enclosure width 975 mm with internal cable sleeves
		0 205 59   0 208 56 Pivoting for enclosure width 725 mm
1	0 205 68   0 208 56	0 205 68   0 208 56 Pivoting for enclosure width 975 mm without internal cable sleeves
		0 205 69   0 208 56 Pivoting for enclosure width 975 mm with internal cable sleeves
1	0 205 79   0 208 56	0 205 79   0 208 56 For fitting DPX on fixing devices or adjustable plates
		<b>Fixed crosspieces</b> Fit onto structural uprights Fixed crosspieces are required for creating an internal cable sleeve
1	0 205 21   0 208 56	0 205 21   0 208 56 Set of 2 crosspieces length 350 mm
		0 205 22   0 208 56 Set of 2 crosspieces length 600 mm
		0 205 23   0 208 56 Set of 2 crosspieces length 850 mm
1	0 205 51   0 208 56	<b>Adjustable crosspieces</b> Fit onto structural uprights Specifically for busbar supports
		0 205 51   0 208 56 Set of 2 crosspieces length 350 mm
		0 205 52   0 208 56 Set of 2 crosspieces length 600 mm
1	0 205 53   0 208 56	0 205 53   0 208 56 Set of 2 crosspieces length 850 mm
		<b>Equipments for partial chassis</b> Kit consisting of 4 fixing plates for reduced functional uprights Cat.No 0 205 12 To be used when assembling a double partial chassis
1	0 205 30   0 208 56	0 205 30   0 208 56 Set of 2 fixed crosspieces length 350 mm
		0 205 32   0 208 56 Set of 2 fixed crosspieces length 600 mm
1	0 205 47   0 208 66	<b>Front covers with hinges and lock</b> For internal cable sleeve
		0 205 48   0 208 67 For external cable sleeve

## Distribution enclosures XL<sup>3</sup> 4000 (continued)



0 205 77



0 205 82

Pack	Cat.Nos	Reversible doors
		Supplied with handle Interchangeable key barrels, to be ordered separately For mounting on front, rear or side
		<b>Curved - metal</b>
	Height (mm)	Width 725 mm
1	2000   2200	Width 975 mm
	0 205 54   0 208 61	
1	0 205 57   0 208 62	
		<b>Curved - glass</b>
1	0 205 64   0 208 63	Width 725 mm
1	0 205 67   0 208 64	Width 975 mm
		<b>Flat - metal</b>
1	0 205 71   0 208 65	Width 475 mm
1	0 205 74	Width 725 mm
1	0 205 77	Width 975 mm
		<b>Flat - glass</b>
	Height 2000 mm	Width 725 mm
1	0 205 84	Width 975 mm
1	0 205 87	

Pack	Cat.Nos	Mounting equipment
		<b>Joining</b>
1	0 205 86	Screws for structural joining
1	0 205 88	Set of 2 L-shaped reinforcement plates
1	0 205 89	Set of 2 flat reinforcement plates
1	0 205 85	Sealing kit IP 55 for use when joining cabinets - length 5 m
1	0 205 10	Kit for joining plinths
		<b>Lifting rings</b>
1	0 205 82	Set of 4 Max. load: 480 kg per ring

For detailed dimensions and installation principle, see e-catalogue



## Distribution enclosures XL<sup>3</sup> 4000

### Functional uprights with pivoting support frame for faceplates

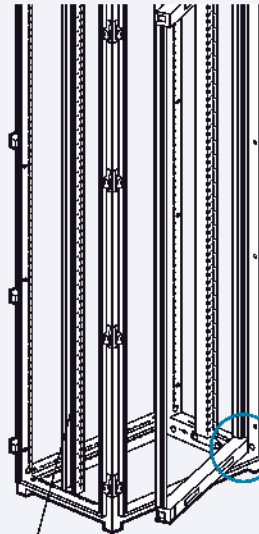

with reduced functional upright  
Cat.No 0 205 12

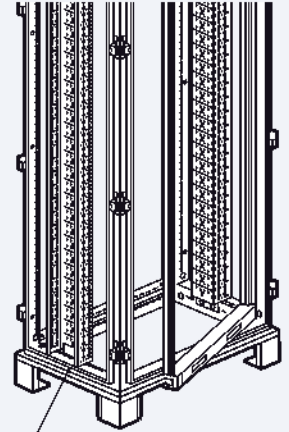

with functional upright  
Cat.No 0 205 13

### Example of double partial chassis with reduced functional uprights Cat.No 0 205 12

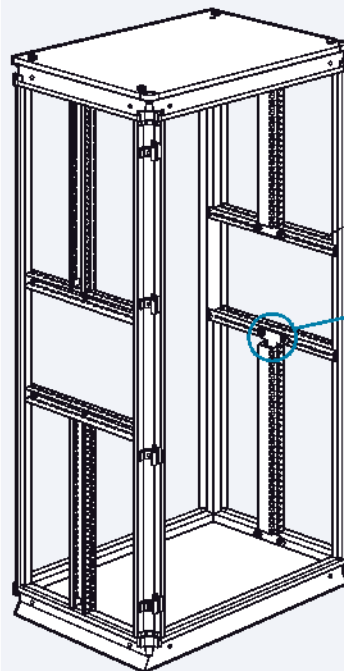

crosspieces  
Cat.No 0 205 31/32

fixing plate  
Cat.No 0 205 30

# Distribution enclosures XL<sup>3</sup> 4000

Enclosures	"Roof-base" assembly	Structural uprights	Plinths	Functional uprights	Faceplate supports		Int. cable sleeves crosspcs	Int. cable sleeves fr. covers	Rear panels	Side panels	Doors			
					fixed	pivoting					Curved Metal	Curved Glass	Flat Metal	Flat Glass
Height 2000 or 2200 mm Width x Depth														
 725 x 425	0 205 04	0 205 00 0 208 50 <sup>(2)</sup>	0 205 14	0 205 12 0 208 52 <sup>(2)</sup>	0 205 58 0 208 55 <sup>(2)</sup>	0 205 68	-	-	0 205 42 0 208 58 <sup>(2)</sup>	0 205 41 0 208 57 <sup>(2)</sup>	0 205 54 0 208 61 <sup>(2)</sup>	0 205 64 0 208 63 <sup>(2)</sup>	0 205 74	0 205 84
 725 x 725	0 205 05	0 205 00 0 208 50 <sup>(2)</sup>	0 205 15	0 205 13 0 208 53 <sup>(2)</sup>	0 205 58 0 208 55 <sup>(2)</sup>	0 205 68	-	-	0 205 42 0 208 58 <sup>(2)</sup>	0 205 42 0 208 58 <sup>(2)</sup>	0 205 54 0 208 61 <sup>(2)</sup>	0 205 64 0 208 63 <sup>(2)</sup>	0 205 74	0 205 84
 725 x 975	0 205 06	0 205 00 0 208 50 <sup>(2)</sup>	0 205 18	0 205 13 0 208 53 <sup>(2)</sup>	0 205 58 0 208 55 <sup>(2)</sup>	0 205 68	-	-	0 205 42 0 208 58 <sup>(2)</sup>	0 205 43 0 208 59 <sup>(2)</sup>	0 205 54 0 208 61 <sup>(2)</sup>	0 205 64 0 208 63 <sup>(2)</sup>	0 205 74	0 205 84
 975 x 475 <sup>(1)</sup>	0 205 07	0 205 00 0 208 50 <sup>(2)</sup>	0 205 17	0 205 12 0 208 52 <sup>(2)</sup> 0 205 16 0 208 54 <sup>(2)</sup>	0 205 58 0 208 55 <sup>(2)</sup> 0 205 59 0 208 56 <sup>(2)</sup>	0 205 69 0 205 79	0 205 21	0 205 47	0 205 43 0 208 59 <sup>(2)</sup>	0 205 41 0 208 57 <sup>(2)</sup>	0 205 57 0 208 62 <sup>(2)</sup>	0 205 67 0 208 64 <sup>(2)</sup>	0 205 77	0 205 87
 975 x 725 <sup>(1)</sup>	0 205 08	0 205 00 0 208 50 <sup>(2)</sup>	0 205 18	0 205 13 0 208 53 <sup>(2)</sup> 0 205 16 0 208 54 <sup>(2)</sup>	0 205 58 0 208 55 <sup>(2)</sup> 0 205 59 0 208 56 <sup>(2)</sup>	0 205 69 0 205 79	0 205 22	0 205 47	0 205 43 0 208 59 <sup>(2)</sup>	0 205 42 0 208 58 <sup>(2)</sup>	0 205 57 0 208 62 <sup>(2)</sup>	0 205 67 0 208 64 <sup>(2)</sup>	0 205 77	0 205 87
 975 x 975 <sup>(1)</sup>	0 205 09	0 205 00 0 208 50 <sup>(2)</sup>	0 205 19	0 205 13 0 208 53 <sup>(2)</sup> 0 205 16 0 208 54 <sup>(2)</sup>	0 205 58 0 208 55 <sup>(2)</sup> 0 205 59 0 208 56 <sup>(2)</sup>	0 205 69 0 205 79	0 205 23	0 205 47	0 205 43 0 208 59 <sup>(2)</sup>	0 205 43 0 208 59 <sup>(2)</sup>	0 205 57 0 208 62 <sup>(2)</sup>	0 205 67 0 208 64 <sup>(2)</sup>	0 205 77	0 205 87

External cable sleeves	"Roof-base" assemblée	Structural uprights	Plinths	Front covers	Rear panels	Side panels	Metal doors
Height 2000 or 2200 mm Width x Depth							
 475 x 475	0 205 01	0 205 00 0 208 50 <sup>(2)</sup>	0 205 11	0 205 48 0 208 67 <sup>(2)</sup>	0 205 41 0 208 57 <sup>(2)</sup>	0 205 41 0 208 57 <sup>(2)</sup>	0 205 71 0 208 65 <sup>(2)</sup>
 475 x 725	0 205 02	0 205 00 0 208 50 <sup>(2)</sup>	0 205 14	0 205 48 0 208 67 <sup>(2)</sup>	0 205 41 0 208 57 <sup>(2)</sup>	0 205 42 0 208 58 <sup>(2)</sup>	0 205 71 0 208 65 <sup>(2)</sup>
 475 x 975	0 205 03	0 205 00 0 208 50 <sup>(2)</sup>	0 205 17	0 205 48 0 208 67 <sup>(2)</sup>	0 205 41 0 208 57 <sup>(2)</sup>	0 205 43 0 208 59 <sup>(2)</sup>	0 205 71 0 208 65 <sup>(2)</sup>

1: With internal cable sleeve  
2: For enclosure height 2200 mm

## Equipment for XL<sup>3</sup> 4000

for modular devices, Vistop, DPX<sup>3</sup> 160/250, DPX-IS 250 on rail

## Equipment for XL<sup>3</sup> 4000

for mounting on plate: DPX-IS 250, 630 and 1600



0 206 01



0 262 39



0 206 05



0 208 00

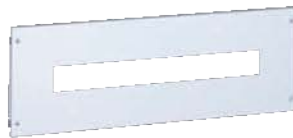

0 209 01



0 208 10

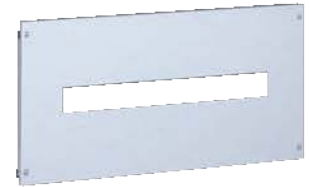

0 209 10

Pack	Cat.Nos	Fixing devices on rail
1	24 modules   36 modules 0 206 01   0 206 51	<b>Rails </b> Comprising: an aluminium profile rail and two 2-position fixing brackets Accept HX <sup>3</sup> 125 A plug-in connection row distribution blocks Fit onto functional uprights For mounting DPX <sup>3</sup> using fixing plates For fixing on XL <sup>3</sup> 800 and XL <sup>3</sup> 4000 functional uprights Accept wire guide Cat.No 4 052 25 (p. 209)
1	<b>N</b> 4 210 71	<b>Fixing plates for mounting DPX<sup>3</sup> on rail </b> For mounting DPX <sup>3</sup> on aluminium rail  or on plate Cat.Nos 0 206 11/61
1	4 210 73	For DPX <sup>3</sup> 160 without side motor-driven handle
1	4 210 68	For DPX <sup>3</sup> 160 with earth leakage module without side motor-driven handle
1	4 210 72	For all DPX <sup>3</sup> 160 devices with side motor-driven handle
1	4 210 74	For DPX <sup>3</sup> 250 without side motor-driven handle
1	4 210 69	For DPX <sup>3</sup> 250 with earth leakage module without side motor-driven handle
1	4 210 69	For all DPX <sup>3</sup> 250 devices with side motor-driven handle
1	0 262 39	<b>Fixing plate for mounting DPX-IS 250 on rail </b> For mounting devices on aluminium rail  or on plate Cat.Nos 0 206 11/61 For DPX-IS 250
1	<b>N</b> 4 052 26	<b>Rail height spacer</b> Designed for simultaneous mounting of modular devices and DPX <sup>3</sup> 160/250 and DPX-IS 250 devices mounted on rail  Cat.Nos 0 206 01/51 or plate Cat.Nos 0 206 11/61 For 20 modules
1	24 modules   36 modules 0 208 00 <sup>1</sup>   0 209 00 <sup>2</sup>	<b>Metal faceplates</b> <b>For modular devices</b> 1/4 turn With captive screws
1	0 208 01 <sup>1</sup>   0 209 01 <sup>2</sup>	<b>For Vistop up to 160 A</b> 1/4 turn With captive screws
1	0 208 10 <sup>1</sup>   0 209 10 <sup>2</sup>	<b>For DPX<sup>3</sup> and DPX-IS 250</b> 1/4 turn With captive screws

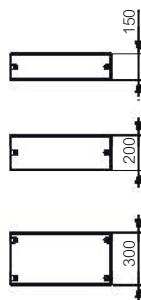

1: For fastening and sealing  
2: Hinges Cat.No 0 209 59 available as an option

Pack	Cat.Nos	Plates for DPX-IS
1	24 modules   36 modules 0 206 05   0 206 55	<b>Direct fixing on functional uprights</b> <b>Fixed plates for device in vertical position</b> For 1 or 2 DPX-IS 250 front or rear terminals
1	0 206 07   0 206 57	For 1 DPX-IS 630 front or rear terminals
1	0 211 00	For 1 DPX-IS 1600 or 1 DPX 1600 front terminals
1	0 211 06   0 211 03	For 1 DPX-IS 1600 or 1 DPX 1600 rear terminals
1	0 206 18	<b>Fixed plates for device in horizontal position</b> For 1 DPX-IS 250 front or rear terminals
1	0 206 19	For 1 DPX-IS 630 front or rear terminals
1	24 modules   36 modules 0 208 10 <sup>1</sup>   0 209 10 <sup>2</sup>	<b>Metal faceplates</b> <b>For 1 DPX-IS 250 in vertical position</b> 1/4 turn With captive screws <sup>(2)</sup>
1	0 209 10 <sup>2</sup>   0 209 60 <sup>2</sup>	<b>For 2 DPX-IS 250 in vertical position</b> 1/4 turn With captive screws
1	0 208 06 <sup>1</sup>   0 209 06 <sup>2</sup>	<b>For 1 DPX-IS 250 in horizontal position</b> With captive screws
1	0 209 18 <sup>2</sup>	<b>For 1 DPX-IS 630 in vertical position</b> 1/4 turn With captive screws Does not allow the use of terminal shields Cat.No 0 262 45
1	0 208 07 <sup>1</sup>   0 209 07 <sup>2</sup>	<b>For 1 DPX-IS 630 in horizontal position</b> With captive screws
1	0 209 19 <sup>2</sup>	<b>For 1 DPX-IS 1600 in vertical position</b> With captive screws
1	24 modules   36 modules 0 211 13 <sup>2</sup>	<b>For 1 DPX-IS 1600 in horizontal position</b> With captive screws
1	0 208 36 <sup>2</sup>	<b>For 1 DPX-IS 1600 in horizontal position</b> With captive screws

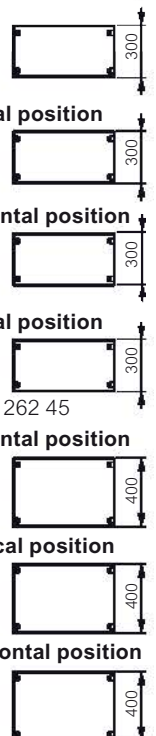

1: For fastening and sealing  
2: Hinges Cat.No 0 209 59 available as an option

## Equipment for XL<sup>3</sup> 4000

for mounting on fixed plate : DPX<sup>3</sup> 160 and DPX<sup>3</sup> 250

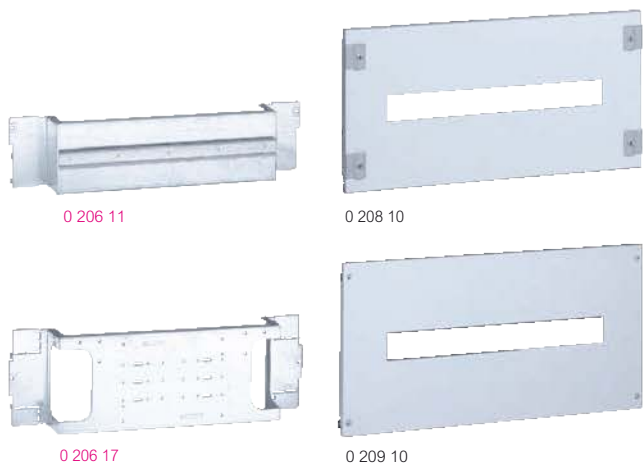

Pack	Cat.Nos	Plates for fixed version DPX <sup>3</sup> 160/250 with front terminals
		Direct fixing on functional uprights
		<b>Devices in vertical position</b>
1	24 modules 0 206 11	Equipped with a rail  for fixing DPX <sup>3</sup> . The DPX <sup>3</sup> must be equipped with a fixing plate Cat.Nos 4 210 68/69/71/72 or plate for manual supply inverter Cat.No 4 210 58. Designed for simultaneous mounting of DPX <sup>3</sup> 160/250 and modular equipment (with spacer Cat.No 0 262 99). Plate for DPX <sup>3</sup> with direct rotary handle. The DPX <sup>3</sup> must be equipped with a fixing plate Cat.Nos 4 210 68/69. Plate for motor-driven supply inverter. The supply inverter must be equipped with a fixing plate Cat.Nos 4 210 58.
1	36 modules 0 206 61	
1	0 206 08	
1	0 206 13	
		<b>Devices in horizontal position</b>
1	24 modules 0 206 15	For cut-out protection for cable passing, use seal Cat.No 0 202 40 (p. 208)
1	0 206 17	For 1 DPX <sup>3</sup> 160 For 1 DPX <sup>3</sup> 250

Pack	Cat.Nos	Metal faceplates
		<b>For DPX<sup>3</sup> in vertical position without direct rotary handle</b>
1	24 modules 0 208 10 <sup>1</sup>	1/4 turn With captive screws With captive screws for DPX <sup>3</sup> 250 with terminal shields
1	36 modules 0 209 10 <sup>2</sup>	
1	0 209 27	
		<b>For DPX<sup>3</sup> in vertical position with direct rotary handle</b>
1	24 modules 0 208 05 <sup>1</sup>	1/4 turn With captive screws
1	0 209 05 <sup>2</sup>	
		<b>For DPX<sup>3</sup> 160</b>
1	0 208 13 <sup>1</sup>	1/4 turn With captive screws
1	0 209 13 <sup>2</sup>	
		<b>For DPX<sup>3</sup> 250</b>
1	0 208 17 <sup>1</sup>	1/4 turn With captive screws
1	0 209 17 <sup>2</sup>	

1: For fastening and sealing  
2: Hinges Cat.No 0 209 59 available as an option

## Equipment for XL<sup>3</sup> 4000

for mounting on fixed plate: DPX<sup>3</sup> 630 and DPX<sup>3</sup> 1600

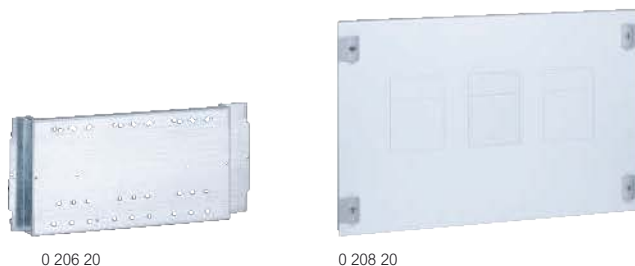

Pack	Cat.Nos	Plates for fixed version DPX <sup>3</sup> 630/1600, with front terminals
		Direct fixing on functional uprights
		<b>Devices in vertical position</b>
1	24 modules 0 206 20 <sup>1</sup>	For 1 to 3 DPX <sup>3</sup> 630 For 1 to 3 DPX <sup>3</sup> 630 with earth leakage module For 1 DPX IS 1600 or 1 DPX <sup>3</sup> 1600 front terminal
1	36 modules 0 206 22 <sup>1</sup>	
1	0 211 00	0 211 02
		<b>Devices in horizontal position</b>
1	0 206 23	For cut-out protection for cable passing, use seal Cat.No 0 202 40 (p. 208)
1	0 211 00	0 211 02
		<b>Metal faceplates for devices in vertical position</b>
		<b>For 1 to 3 DPX<sup>3</sup> 630 only</b>
1	24 modules 0 208 20 <sup>2</sup>	1/4 turn With captive screws
1	36 modules 0 209 20 <sup>3</sup>	
		<b>For 1 to 3 DPX<sup>3</sup> 630 with downstream earthleakage module</b>
1	0 208 22 <sup>2</sup>	1/4 turn With captive screws
1	0 209 22 <sup>3</sup>	
		<b>For 1 DPX<sup>3</sup> 1600</b>
1	0 211 10 <sup>2</sup>	1/4 turn With captive screws
1	0 211 11 <sup>3</sup>	
		0 211 12 <sup>3</sup>

Pack	Cat.Nos	Metal faceplates for devices in vertical position
		<b>For 1 DPX<sup>3</sup> 630 with or without earth leakage module without motor</b>
1	24 modules	1/4 turn With captive screws
1	0 208 23 <sup>2</sup>	
1	0 209 21 <sup>3</sup>	
		<b>For 1 DPX<sup>3</sup> 630 with or without earth leakage module with motor</b>
1	0 209 23 <sup>3</sup>	With captive screws
		<b>For 1 DPX<sup>3</sup> 1600</b>
1	24 modules 0 208 34 <sup>3</sup>	1/4 turn With captive screws
1	36 modules 0 209 34 <sup>3</sup>	
		0 209 84 <sup>3</sup>

1: For 2 DPX 630 4P  
2: For fastening and sealing  
3: Hinges Cat.No 0 209 59 available as an option

## Equipment for XL<sup>3</sup> 4000

for mounting on adjustable plate: DPX<sup>3</sup> 160, DPX<sup>3</sup> 250 fixed version

## Equipment for XL<sup>3</sup> 4000

for mounting on adjustable plate: plug-in DPX<sup>3</sup> 160, DPX<sup>3</sup> 250

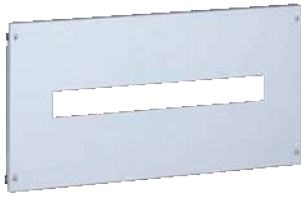

0 209 10



0 208 13

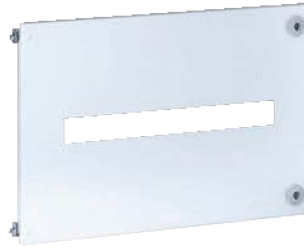

0 212 11



0 212 13

Pack	Cat.Nos	Fixing fixed version DPX <sup>3</sup> 160/250 with front or rear terminals
		<b>Adjustable fixing devices for MCCBs in vertical position</b> The MCCBs are fixed using special mounting plates Allow mounting direct rotary handles and front motor-driven handles
1	24 modules 0 207 90	For 1 to 3 DPX <sup>3</sup>
1	36 modules 0 207 61	For 2 DPX <sup>3</sup> supply inverter
		<b>Mounting plates for devices in vertical position</b>
1	0 207 49	For 1 DPX <sup>3</sup> 160
1	0 206 71	For 1 DPX <sup>3</sup> 160 in supply inverter
1	0 207 64	For 1 DPX <sup>3</sup> 250
1	0 206 73	For 1 DPX <sup>3</sup> 250 in supply inverter
		<b>Adjustable plates for devices in horizontal position</b>
1	24 modules 0 207 94	For 1 DPX <sup>3</sup> 160
1	0 207 96	For 1 DPX <sup>3</sup> 250

Pack	Cat.Nos	Metal faceplates for devices in vertical position
		<b>For DPX<sup>3</sup> with or without motor driven handle</b> 1/4 turn With captive screws
1	24 modules 0 208 10 <sup>1</sup>	
1	36 modules 0 209 10 <sup>2</sup>	
		<b>For 1 to 3 DPX<sup>3</sup> with direct rotary handle</b> 1/4 turn With captive screws
1	0 208 05 <sup>1</sup>	
1	0 209 05 <sup>2</sup>	

Pack	Cat.Nos	Metal faceplates for devices in horizontal position
		Allow mounting front motor-driven handles
		<b>For 1 DPX<sup>3</sup> 160</b> 1/4 turn With captive screws
1	24 modules 0 208 13 <sup>2</sup>	
1	0 209 13 <sup>1</sup>	
		<b>For 1 DPX<sup>3</sup> 250</b> 1/4 turn With captive screws
1	0 208 17 <sup>2</sup>	
1	0 209 17 <sup>1</sup>	

1: Hinges Cat.No 0 209 59 available as an option  
2: For fastening and sealing

Pack	Cat.Nos	Fixing plug-in version DPX <sup>3</sup> 160/250 with front or rear terminals
		<b>Adjustable fixing devices in vertical position</b> The devices are fixed using special mounting plates Allow mounting direct rotary handles and front motor-driven handles
1	0 207 91	For 1 to 3 DPX <sup>3</sup>
1	0 206 69	For 2 DPX <sup>3</sup> supply inverter
		<b>Mounting plates for devices in vertical position</b>
1	0 207 59	For 1 DPX <sup>3</sup> 160
1	0 206 81	For 1 DPX <sup>3</sup> 160 in supply inverter
1	0 207 69	For 1 DPX <sup>3</sup> 250
1	0 206 83	For 1 DPX <sup>3</sup> 250 in supply inverter
		<b>Adjustable plates for devices in horizontal position</b>
1	0 207 95	For 1 DPX <sup>3</sup> 160
1	0 207 97	For 1 DPX <sup>3</sup> 250
		<b>Metal faceplates for devices in vertical position</b>
		<b>For 1 to 3 DPX<sup>3</sup> with or without front motor-driven handle</b> With hinges and lock
1	0 212 11	
		<b>For 1 to 3 DPX<sup>3</sup> with direct rotary handle</b> With hinges and lock
1	0 212 08	
		<b>Metal faceplate for devices in horizontal position</b> Allow mounting front motor-driven handles
		<b>For 1 DPX<sup>3</sup></b> With hinges and lock
1	0 212 13	

## Equipment for XL<sup>3</sup> 4000

for mounting on adjustable plates: DPX<sup>3</sup> 630 fixed version

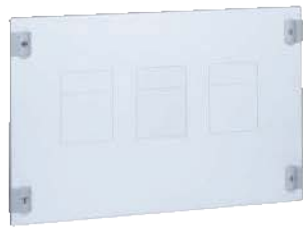



0 208 20

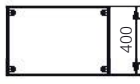

0 208 23

Adjustable plates are used for front terminal/rear terminal connection and mounting of motor-driven or rotary handles

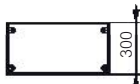
Pack	Cat.Nos	
		<b>Fixing fixed version DPX<sup>3</sup> 630, with front or rear terminals</b>
		<b>Adjustable fixing devices for MCCBs in vertical position</b>
1	24 modules 0 207 20	The MCCBs are fixed using special plates For 1 to 3 DPX <sup>3</sup> 630
1	36 modules 0 207 70	
1	0 207 22	For 1 to 3 DPX <sup>3</sup> 630 with earth leakage module
1	0 207 72	
		<b>Mounting plates for devices in vertical position</b>
1	24 modules 0 207 85	DPX <sup>3</sup> 630
1	0 207 86	DPX <sup>3</sup> 630 with earth leakage module
		<b>Adjustable plates for devices in horizontal position</b>
1	24 modules 0 207 93	For 1 DPX <sup>3</sup> 630 with or without elcbs
		<b>Metal faceplates for devices in vertical position</b>
		<b>For 1 to 3 DPX<sup>3</sup> 630 only</b>
1	24 modules 0 208 20 <sup>1</sup>	1/4 turn
1	36 modules 0 209 20 <sup>2</sup>	With captive screws
		
1	0 208 22 <sup>1</sup>	<b>For 1 to 3 DPX<sup>3</sup> 630 with downstream elcbs</b>
1	0 209 22 <sup>2</sup>	1/4 turn
		With captive screws
		
		<b>Metal faceplates for devices in horizontal position</b>
		<b>For 1 DPX<sup>3</sup> 630 with or without elcbs</b>
1	24 modules 0 208 23 <sup>1</sup>	1/4 turn
1	0 209 21 <sup>2</sup>	With captive screws
		
1	0 209 23 <sup>2</sup>	<b>For 1 DPX<sup>3</sup> 630 with or without elcbs with motor-driven or rotary handle</b>
		With captive screws

1: For fastening and sealing  
2: Hinges Cat.No 0 209 59 available as an option

## Equipment for XL<sup>3</sup> 4000 for mounting on adjustable

plates: DPX<sup>3</sup> 630 plug-in, draw-out version or supply invertors



0 207 21



0 207 87

Adjustable plates are used for front terminal/rear terminal connection and mounting of motor-driven or rotary handles

Pack	Cat.Nos	
		<b>Fixing plug-in or draw-out version DPX<sup>3</sup> 630, with front or rear terminals</b>
		<b>Adjustable fixing devices for MCCBs in vertical position</b>
1	0 207 21	The MCCBs are fixed using special plates For 1 to 3 DPX <sup>3</sup> 630
1	0 207 23	For 1 to 3 DPX <sup>3</sup> 630 with elcbs
		<b>Mounting plates for devices in vertical position</b>
1	0 207 87	For device only
1	0 207 88	For device with elcbs
1	0 207 98	For plug-in or draw-out device with or without elcbs
		<b>Metal faceplates for plug-in devices</b>
		Faceplates with hinges and lock
		<b>Devices in vertical position</b>
1	0 212 20	For 1 to 3 DPX <sup>3</sup> 630
		<b>Devices in horizontal position</b>
1	0 212 17	For device with or without elcbs
		<b>Metal faceplates for draw-out devices</b>
		Faceplates with hinges and lock
		<b>Devices in vertical position with or without rotary handle</b>
1	0 212 21	For 1 DPX <sup>3</sup> 630 without elcb
1	0 212 23	For 1 DPX <sup>3</sup> 630 without elcb
		<b>Devices in vertical position with motor-driven handle</b>
1	0 212 04	For 1 device without elcb
		<b>Devices in horizontal position</b>
1	0 212 18	For 1 device with or without downstream earth leakage module with or without rotary handle
1	0 212 19	For 1 device with or without elcbs mounted underneath with motor-driven handle
		<b>Fixing supply invertors DPX<sup>3</sup></b>
		<b>Devices in vertical position</b>
1	0 206 76	For 2 devices
		<b>Metal faceplates for supply invertors</b>
		<b>For fixed version DPX<sup>3</sup></b>
		With captive screws
1	0 209 76 <sup>1</sup>	For 2 devices with or without motor-driven handle
		<b>For draw-out DPX<sup>3</sup></b>
		With hinges and lock
1	0 212 95	For 2 devices with motor-driven handle

1: Hinges Cat.No 0 209 59 available as an option



## Equipment for XL<sup>3</sup> 4000

for mounting on adjustable plates: DPX<sup>3</sup> 1600 fixed version

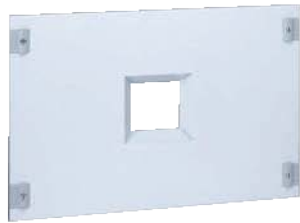

0 211 10

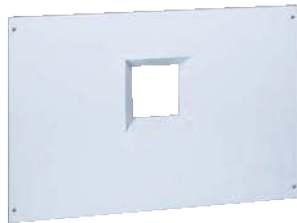

0 209 34

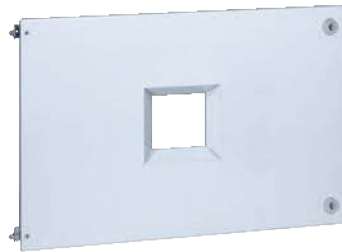

0 211 15

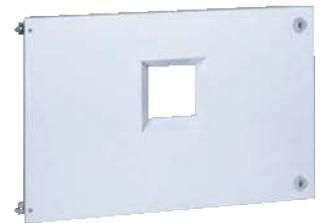

0 212 34

Adjustable plates are used for front terminal/rear terminal connection and mounting of motor-driven or rotary handles

Pack	Cat.Nos	Fixing fixed version devices
1	24 modules   36 modules 0 211 04	<b>Adjustable plates for devices in vertical position</b> For 1 DPX <sup>3</sup> 1600 with front terminals
1	0 211 06   0 211 03	For 1 DPX-IS 1600 or 1 DPX <sup>3</sup> 1600 with rear terminals
1	24 modules   36 modules 0 211 00 <sup>3</sup>   0 211 02	<b>Fixed plate for devices in horizontal or vertical position</b> For 1 DPX <sup>3</sup> 1600 or DPX-IS 1600 front terminals
1	0 207 36	<b>Adjustable plate for devices in horizontal position</b> For 1 DPX-IS 1600 or DPX <sup>3</sup> 1600 rear terminals in vertical position
1	24 modules   36 modules 0 211 10 <sup>1</sup>   0 211 11 <sup>2</sup>	<b>Metal faceplates for devices in vertical position</b> <b>For 1 DPX<sup>3</sup> 1600 only</b> 1/4 turn With captive screws
1	24 modules 0 211 14 <sup>2</sup>	<b>For 1 DPX<sup>3</sup> 1600 with rotary or motor-driven handle</b> With captive screws
1	24 modules   36 modules 0 208 34 <sup>1</sup>   0 209 34 <sup>2</sup>	<b>Metal faceplates for devices in horizontal position</b> <b>For 1 DPX<sup>3</sup> 1600 only</b> 1/4 turn With captive screws
1	24 modules 0 209 35 <sup>2</sup>	<b>For 1 DPX<sup>3</sup> 1600 rear terminals with motor-driven or rotary handle and front terminals with rotary handle</b> With captive screws
1	0 209 36 <sup>2</sup>	<b>For 1 DPX<sup>3</sup> 1600 front terminals with motor-driven handle</b> With captive screws

1: For fastening and sealing  
2: Hinges Cat.No 0 209 59 available as an option  
3: DPX-IS only in vertical position

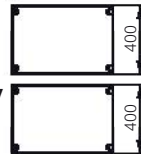

## Equipment for XL<sup>3</sup> 4000 for mounting on adjustable plates: DPX<sup>3</sup> 1600 draw-out version and supply invertors

Adjustable plates are used for front terminal/rear terminal connection and mounting of motor-driven or rotary handles

Pack	Cat.Nos	Fixing draw-out version DPX <sup>3</sup> 1600, with front or rear terminals
1	24 modules 0 211 05	<b>Adjustable plates for devices in vertical position</b> For 1 DPX <sup>3</sup> 1600
1	0 207 35	<b>Adjustable plates for devices in horizontal position</b> For 1 DPX <sup>3</sup> 1600 with rear terminals
1	24 modules 0 211 15	<b>Metal faceplates for draw-out version</b> Faceplates with hinges and lock <b>Devices in vertical position</b> For 1 DPX <sup>3</sup> 1600
1	0 211 16	For 1 DPX <sup>3</sup> 1600 with motor-driven or rotary handle
1	0 212 34	<b>Devices in horizontal position</b> For 1 DPX <sup>3</sup> 1600
1	0 212 35	For 1 DPX <sup>3</sup> 1600 with motor-driven or rotary handle
1	24 modules 0 206 86	<b>Fixing supply inverter version DPX<sup>3</sup> 1600</b> <b>Devices in horizontal position</b> For 2 fixed DPX <sup>3</sup> 1600
1	0 206 87	For 2 draw-out DPX <sup>3</sup> 1600
1	24 modules 0 209 86 <sup>1</sup>   0 209 87 <sup>1</sup>	<b>Metal faceplates for supply invertors</b> <b>For fixed version DPX<sup>3</sup> 1600</b> With captive screws For 2 DPX <sup>3</sup> 1600 For 2 DPX <sup>3</sup> 1600 with motor-driven handle
1	0 212 37	<b>For draw-out version DPX<sup>3</sup> 1600</b> With hinges and lock For 2 DPX <sup>3</sup> 1600 with motor-driven handle

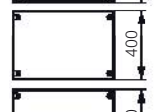

1: Hinges Cat.No 0 209 59 available as an option

## Equipment for XL<sup>3</sup> 4000

for mounting on plate: DMX<sup>3</sup> and DMX<sup>3</sup>-I fixed or draw-out version



0 207 51



0 209 38

## Solid faceplates and accessories for XL<sup>3</sup> 4000



0 208 44



0 209 59



0 200 51

Pack	Cat.Nos	Fixing devices for DMX <sup>3</sup> and DMX <sup>3</sup> -I
1	24 modules   36 modules 0 207 51	<b>For DMX<sup>3</sup> fixed version</b> For 1 DMX <sup>3</sup> 2500/4000, N/H/L, 3P/4P, and DMX <sup>3</sup> -I Width 600 mm
1	0 207 52	For 1 DMX <sup>3</sup> 2500/4000, N/H/L, 3P/4P, and DMX <sup>3</sup> -I Width 850 mm
1	0 207 53	<b>For DMX<sup>3</sup> draw-out version</b> For 1 DMX <sup>3</sup> 2500/4000, N/H/L, 3P/4P, and DMX <sup>3</sup> -I Width 600 mm
1	0 207 54	For 1 DMX <sup>3</sup> 2500/4000, N/H/L, 3P/4P, and DMX <sup>3</sup> -I Width 850 mm

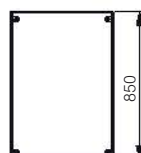
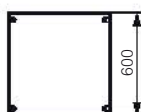
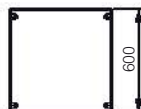

Pack	Cat.Nos	Metal faceplates for DMX <sup>3</sup> and DMX <sup>3</sup> -I fixed or draw-out version
1	24 modules   36 modules 0 209 38	<b>Width 600 mm</b> Faceplates with hinges and lock For 1 DMX <sup>3</sup> 2500/4000, N/H/L, 3P, or 1 DMX <sup>3</sup> 2500, N/H, 4P or 1 DMX <sup>3</sup> -I 2500
1	0 209 39	For 1 DMX <sup>3</sup> -L 2500, 4P, or 1 DMX <sup>3</sup> 4000, N/H/L, 4P or 1 DMX <sup>3</sup> -I 4000
1	0 209 48	<b>Width 850 mm</b> For 1 DMX <sup>3</sup> 2500/4000, N/H/L, 3P/4P or 1 DMX <sup>3</sup> -I 2500/4000

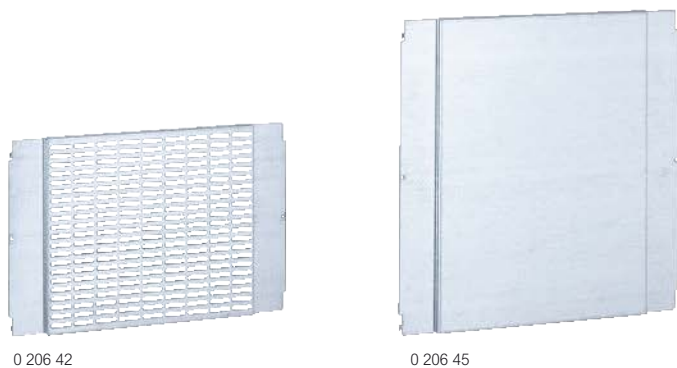

Pack	Cat.Nos	Metal solid faceplates
		<b>1/4 turn</b>
		For fastening and sealing
		Height (mm)
1	24 modules 0 208 40	50
1	0 208 41	100
1	0 208 42	150
1	0 208 43	200
1	0 208 44	300
1	0 208 45	400
1	0 208 46	600
		<b>With captive screws</b>
		Hinges Cat.No 0 209 59 available as an option
		Height (mm)
1	24 modules   36 modules 0 209 40   0 209 90	50
1	0 209 41   0 209 91	100
1	0 209 42   0 209 92	150
1	0 209 43   0 209 93	200
1	0 209 44   0 209 94	300
1	0 209 45   0 209 95	400
1	0 209 46   0 209 96	600
		<b>With hinges and lock</b>
1	0 212 45	100
1	0 212 47	200
1	0 212 48	300
		<b>Accessories for natural ventilation</b>
		Assist natural ventilation
		Screw mounting
1	24 modules   36 modules 0 209 49   0 209 99	<b>Perforated faceplates</b> Height 200 mm
		<b>Perforated panels</b>
1	0 205 44	For plinth 725 mm width
1	0 205 45	For plinth 975 mm width
		<b>Distance piece</b>
1	0 205 46	Distance piece for roof heightening
		<b>Accessories for faceplates</b>
		<b>Hinges</b>
1	0 209 59	Set of 2 Fit on screw mounting faceplates
		<b>Blanking plates</b>
		For metal or insulated faceplates
20	0 200 51	24 modules, smooth adjustable strip
10	0 016 65	18 modules, can be separated into modules or 1/2 modules
		<b>Clip-on holder for adhesive labels</b>
10	0 203 99	Supplied with sheet of labels for marking rows on faceplate 24 modules

## Accessories and faceplates for XL<sup>3</sup> 4000



Pack	Cat.Nos	Universal plates
		Fit onto the functional uprights
1	0 206 41	<b>Perforated plates width 600 mm</b>
1	0 206 42	Height 200 mm
		Height 400 mm
		<b>Solid plates width 600 mm</b>
1	0 206 43	Height 200 mm
1	0 206 44	Height 400 mm
1	0 206 45	Height 600 mm
		<b>Solid plates width 850 mm</b>
1	0 206 46	Height 400 mm
		<b>Adjustable solid plates</b>
1	0 206 40	Height 100 mm, width 600 mm
1	0 206 47	Height 200 mm, width 600 mm
1	0 206 48	Height 400 mm, width 600 mm
1	0 206 49	Height 200 mm, width 850 mm
1	0 206 90	Height 100 mm, width 850 mm
		<b>Solid mounting plate</b>
1	0 205 40	Supplied with depth adjustment runner Height 1800 mm, width 600 mm
		<b>Universal  rails</b>
1	0 206 04	Fit onto the functional uprights Width 600 mm (24 modules)
1	0 206 54	Width 850 mm (36 modules)
		<b>Adjustable universal fixing devices</b>
		Comprising a  rail and 2 adjustable fixing brackets
1	0 206 02	Fit onto the functional uprights For 24 module cabinets and enclosures
1	0 206 52	For 36 module cabinets and enclosures
		<b>Lighting for panel</b>
1	0 209 89	<b>Lighting kit</b> Kit for metal XL <sup>3</sup> 800/4000, comprising fluorescent lamp, fixings and metal screw-mounting faceplate

Pack	Cat.Nos	Wiring
		<b>Lina 25 ducting fixing supports</b>
		For horizontal and vertical mounting and height adjustment of Lina 25 ducting
		Fit directly onto the functional uprights
1	0 204 70	Set of 2, for 36 module enclosures
1	0 205 70	Set of 2, for 24 module enclosures
		<b>Lina 25 ducting</b>
		Length: 2 m
		Width x Height (mm)
48	0 362 07	40 x 60
40	0 362 08	40 x 80
32	0 362 12	60 x 60
32	0 362 13	60 x 80
100	0 200 80	<b>Isolating rivet</b> For fixing Lina 25 ducting on functional uprights
		<b>Accessories</b>
		<b>Clip nuts and screws</b>
		1/4 fastening on front panel
50	0 200 92	Clip nuts for M6 screws
20	0 200 91	M6 screws
6	0 200 98	<b>Aerosol paint spray</b> RAL 7035 - 400 ml
		<b>Cable fixing supports</b>
1	0 205 21	Set of 2 crosspieces length 350 mm
1	0 205 22	Set of 2 crosspieces length 600 mm
1	0 205 23	Set of 2 crosspieces length 850 mm
		<b>Roof reinforcement bracket</b>
1	0 205 29	Set of 2 brackets for XL <sup>3</sup> 4000 - CEP Zucchini connection



0 211 37

Assembly consisting of:  
 - Roof-base Cat.No 0 211 35  
 - Structural uprights Cat.No 0 211 36  
 - Functional uprights Cat.No 0 211 37  
 - Rear panel Cat.No 0 211 41  
 - Support frame for faceplates Cat.No 0 208 55  
 - Lifting rings Cat.No 0 205 82



0 208 00



0 211 40



0 211 39

IP 30 - IK 07

Consist of the combination of a "roof-base" assembly, structural uprights, rear and side panels RAL 7035, plinths RAL 7004  
 Height 2200 mm, usable faceplate height 2000 mm

Pack	Cat.Nos	Enclosures modular metal															
1	0 211 36	<b>Structural uprights</b> Fit onto the "roof-base" assembly Take the side and rear panels Set of 4 uprights															
		<b>"Roof-base" for enclosure</b> Fitted with cable entry plates Take the structural uprights															
		<table border="1"> <thead> <tr> <th>Depth (mm)</th> <th colspan="2">Width (mm)</th> </tr> <tr> <td></td> <th>external</th> <th>usable</th> </tr> </thead> <tbody> <tr> <td>1 0 211 33</td> <td>475</td> <td>1300</td> </tr> <tr> <td>1 0 211 34</td> <td>725</td> <td>1300</td> </tr> <tr> <td>1 0 211 35</td> <td>975</td> <td>1300</td> </tr> </tbody> </table>	Depth (mm)	Width (mm)			external	usable	1 0 211 33	475	1300	1 0 211 34	725	1300	1 0 211 35	975	1300
Depth (mm)	Width (mm)																
	external	usable															
1 0 211 33	475	1300															
1 0 211 34	725	1300															
1 0 211 35	975	1300															
		<b>Side panels</b> Fixed with screws															
1	0 208 57	Width 475 mm															
1	0 208 58	Width 725 mm															
1	0 208 59	Width 975 mm															
		<b>Rear panel</b> Fixed with screws															
1	0 211 41	Width 1300 mm (supplied in two parts)															
		<b>Finishing panels IP 30</b> 1300 x 2000 mm															
1	0 211 48																
		<b>Plinths that can be placed side by side</b>															
		<table border="1"> <thead> <tr> <th>Height (mm)</th> <th>Depth (mm)</th> <th>Width (mm)</th> </tr> </thead> <tbody> <tr> <td>1 0 211 30</td> <td>100</td> <td>475</td> </tr> <tr> <td>1 0 211 31</td> <td>100</td> <td>725</td> </tr> <tr> <td>1 0 211 32</td> <td>100</td> <td>975</td> </tr> </tbody> </table>	Height (mm)	Depth (mm)	Width (mm)	1 0 211 30	100	475	1 0 211 31	100	725	1 0 211 32	100	975			
Height (mm)	Depth (mm)	Width (mm)															
1 0 211 30	100	475															
1 0 211 31	100	725															
1 0 211 32	100	975															
		<b>Equipment</b>															
		<b>Functional uprights</b> For fixing mounting equipment (faceplate, rails...) Set of 2 functional uprights															
1	0 211 37																
		<b>Support frame for faceplates</b> Fixed for enclosure width 725 mm or enclosure width 975 mm															
1	0 208 55																
		<b>Isolating supports for busbars 6300 A</b> Supports for 3 bars 200 x 10 mm (per phase)															
1	0 373 12	Fixed support															
1	0 373 13	Additional support Mounted in addition to fixed support Cat.No 0 373 12 to comply with the distances (depending on the Isc)															

Pack	Cat.Nos	Mounting equipment
		<b>Joining</b>
1	0 205 86	Screws for structural joining
1	0 205 88	Set of 2 L-shaped reinforcement plates
1	0 205 89	Set of 2 flat reinforcement plates
		<b>Lifting rings</b>
1	0 205 82	Set of 4 Max. load: 480 kg per ring
		<b>Fixing modular devices on rail</b>
		<b>Rail</b> Comprising: an aluminium profile rail and two 2-position fixing brackets Fit onto functional uprights
1	0 211 42	For fixing on XL <sup>3</sup> 6300 functional uprights 36 modules
		<b>Metal faceplate for rail equipment</b> Height 200 mm
1	0 208 00	
		<b>Fixing devices for DMX<sup>3</sup> 6300</b>
		<b>Fixing plates</b> For 1 DMX <sup>3</sup> 6300 3P/4P fixed version For 1 DMX <sup>3</sup> 6300 3P/4P draw-out version
1	0 211 38	
1	0 211 40	
		<b>Metal faceplate</b> For 1 DMX <sup>3</sup> 6300 3P/4P fixed or draw-out version
1	0 211 39	
		<b>Metal solid faceplates</b>
1	0 211 44	Height 200 mm, width 1300 mm
1	0 211 45	Height 400 mm, width 1300 mm
		<b>Forms of separation equipment</b>
1	0 211 46	DMX <sup>3</sup> 6300 compartment kit (form 4b)
1	0 211 47	Partitioning for 6300 A busbars
1	0 211 49	Kit for horizontal separation (up and down)



# Distribution enclosures XL<sup>3</sup> 6300

## Installation principle

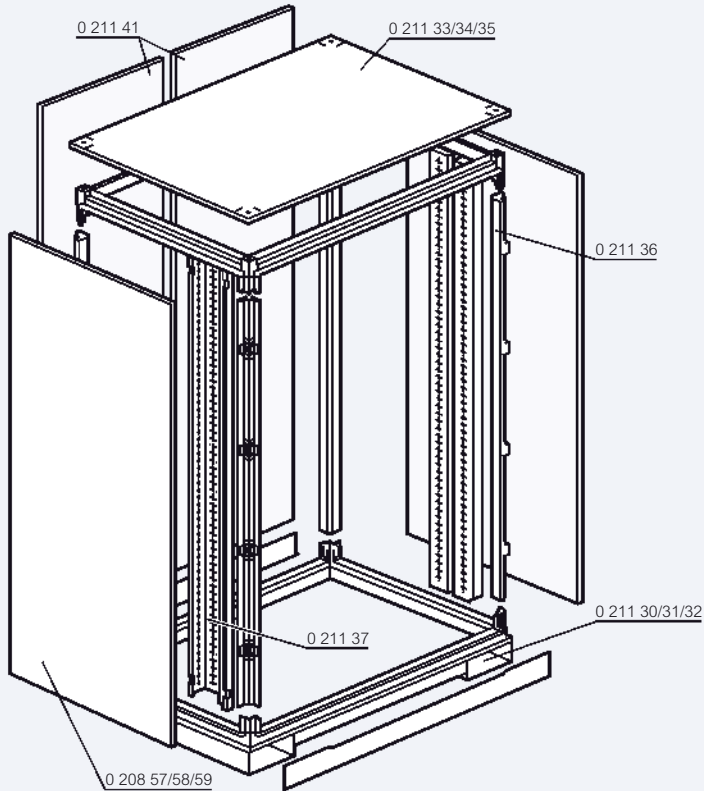

## Dimensions

External dimensions (mm)

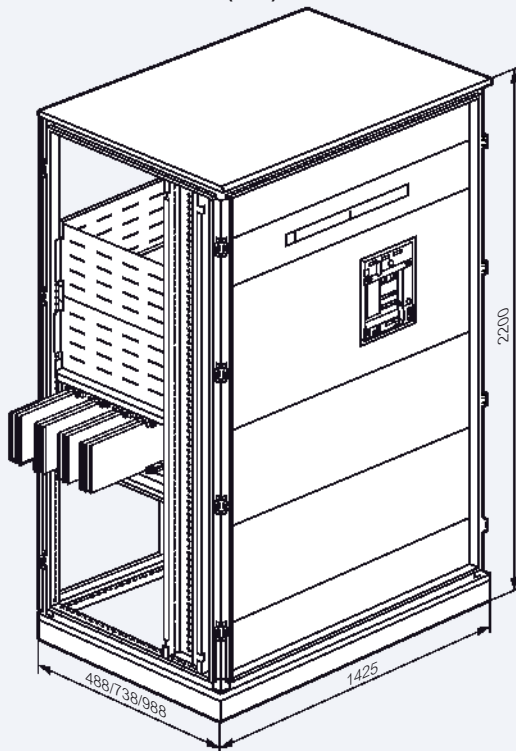

## Mounting DXM<sup>3</sup> 6300 fixed version with Cat.No 0 211 38

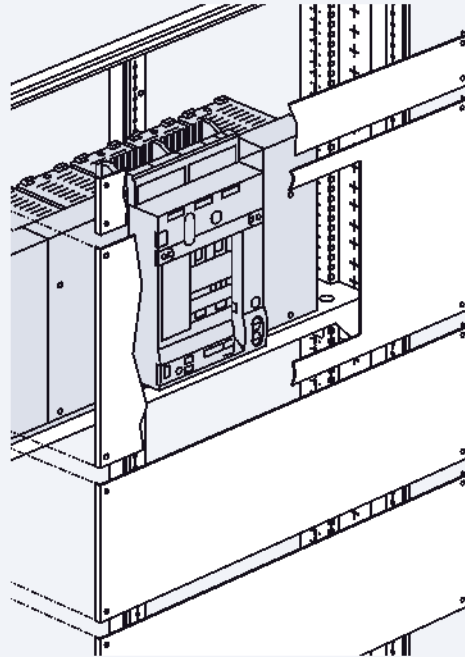

## Mounting DMX<sup>3</sup> 6300 draw-out version with Cat.No 0 211 40

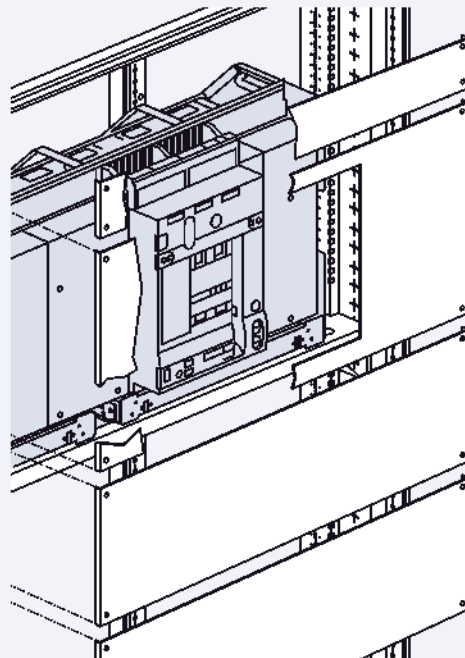



# Essential tool for all levels of forms

XL PRO<sup>3</sup> determines the partitioning and automatically inserts all the necessary catalogue numbers according to required level of form

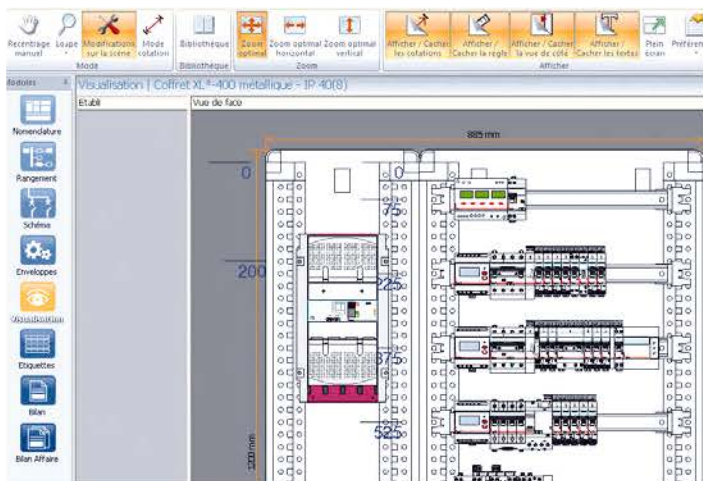

## MAIN FEATURES

- All level of forms from 1 to 4b
- Choice of the distribution system
- Automatic generation of the the circuit diagram and calculation of the most suitable type of enclosure
- Preview of the electrical switchboard
- Complete parts list and purchase order

## MORE INFORMATION



Get detailed information on many digital or printed supports on [www.export.legrand.com](http://www.export.legrand.com) or contact your Area Commercial Manager in order to obtain your XLPro<sup>3</sup> software.

Designation	
Top or bottom horizontal separation kit	
Front panel partitioning DMX <sup>3</sup>	
Front panel side partitioning	
Horizontal partitioning for functional units	
Kit for vertical separation between enclosure and cable sleeve	
Kit for vertical separation between internal cable sleeve and external cable sleeve	
L-shaped separation kit for horizontal busbars 1600 A max.	
U-shaped separation kit for horizontal busbars 1600 A max.	
L-shaped separation kit for horizontal busbars 4000 A max.	
U-shaped separation kit for horizontal busbars 4000 A max.	
U-shaped separation kit for horizontal busbars 6300 A max.	
U-shaped separation kit for horizontal busbars 1600 A max.	
U-shaped separation kit for horizontal busbars 4000 A max.	
U-shaped separation kit for horizontal busbars 1600 A max.	
U-shaped separation kit for horizontal busbars 4000 A max.	
Side vertical divider for DPX 1600	
Side partition with and caps for functional units separation	
Vertical partitioning for rear busbars	
Partitioning for rear busbars	
Horizontal busbar partitioning	
Rear vertical partitioning	
DPX <sup>3</sup> compartment kit	
Partitioning for cell without horizontal busbars	
Bottom busbar area closure	
Rear partitioning divider for space compartment	
DMX <sup>3</sup> 2500/4000, compartment kit	
DMX <sup>3</sup> 2500/4000, compartment kit	
DMX <sup>3</sup> 6300, kit for horizontal separation	

Complementary information	Forms of separation and type of connection (terminals)							
	2a	2b		3a	3b		4a	4b
	rear terminals	front terminals	rear terminals	rear terminals	front terminals	rear terminals	front terminals	rear terminals
width 24 modules	0 208 91				0 208 91	0 208 91	0 208 91	0 208 91
width 36 modules	0 208 99				0 208 99	0 208 99	0 208 99	0 208 99
width 24 modules	0 208 08			0 208 08				
width 36 modules	0 208 09			0 208 09				
				0 208 68		0 208 68		0 208 68
width 24 modules			0 208 92	0 208 92	0 208 92	0 208 92	0 208 92	0 208 92
width 36 modules			0 205 92	0 205 92	0 205 92	0 205 92	0 205 92	0 205 92
for enclosure depth 475 mm		0 208 27			0 208 27		0 208 27	
for enclosure depth 725 mm		0 208 28			0 208 28		0 208 28	
for enclosure depth 975 mm		0 208 29			0 208 29		0 208 29	
for enclosure depth 475 mm		0 208 37			0 208 37		0 208 37	
for enclosure depth 725 mm		0 208 38			0 208 38		0 208 38	
for enclosure depth 975 mm		0 208 39			0 208 39		0 208 39	
for enclosure depth 475 mm		0 205 36			0 205 36		0 205 36	
for enclosure depth 725 mm		0 205 37			0 205 37		0 205 37	
for enclosure depth 725 mm		0 205 38			0 205 38		0 205 38	
for enclosure depth 975 mm		0 205 39			0 205 39		0 205 39	
for XL <sup>3</sup> 6300 enclosures		0 211 47			0 211 47		0 211 47	
for internal cable sleeves depth 475 mm		0 208 70			0 208 70		0 208 70	
for internal cable sleeves depth 725 mm		0 208 71			0 208 71		0 208 71	
for internal cable sleeves depth 725 mm		0 208 72			0 208 72		0 208 72	
for internal cable sleeves depth 975 mm		0 208 76			0 208 76		0 208 76	
for external cable sleeves depth 475 mm		0 208 73			0 208 73		0 208 73	
for external cable sleeves depth 725 mm		0 208 74			0 208 74		0 208 74	
for external cable sleeves depth 725 mm		0 208 75			0 208 75		0 208 75	
for external cable sleeves depth 975 mm		0 208 86			0 208 86		0 208 86	
		0 205 96			0 205 96		0 205 96	
height 200 mm					0 205 97		0 205 97	
height 300 mm					0 205 98		0 205 98	
height 400 mm					0 205 99		0 205 99	
for enclosure depth 725 mm			0 208 48			0 208 48		
for enclosure depth 975 mm			0 208 49			0 208 49		
height 200 mm			0 208 77			0 208 77		
height 300 mm			0 208 78			0 208 78		
height 400 mm			0 208 79			0 208 79		
for enclosure depth 725 mm			0 208 93			0 208 93		
for enclosure depth 975 mm			0 208 94			0 208 94		0 208 94
						0 208 69		0 208 69
height 200 mm								0 208 87
height 300 mm								0 208 88
height 400 mm								0 208 89
to close last DPX compartment								0 208 95
								0 208 96
								0 208 97
width 24 modules (enclosure depth 725 mm)		0 208 02	0 208 02		0 208 02	0 208 02	0 208 02	0 208 02
width 36 modules (enclosure depth 725 mm)		0 208 03	0 208 03		0 208 03	0 208 03	0 208 03	0 208 03
width 24 modules (enclosure depth 975 mm)		0 208 18	0 208 18		0 208 18	0 208 18	0 208 18	0 208 18
width 36 modules (enclosure depth 975 mm)		0 208 19	0 208 19		0 208 19	0 208 19	0 208 19	0 208 19
for XL <sup>3</sup> 6300 enclosures		0 211 46	0 211 46		0 211 46	0 211 46	0 211 46	0 211 46
for XL <sup>3</sup> 6300 enclosures		0 211 49	0 211 49		0 211 49	0 211 49	0 211 49	0 211 49

## Definitions (standard EN 60439-1)

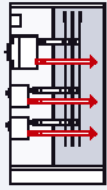

**Form 2a**  
Separation of the busbars from the functional units  
The terminals for external conductors do not need to be separated from the busbars

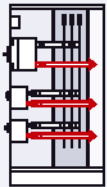

**Form 2b**  
Separation of the busbars from the functional units  
The terminals for external conductors are separated from the busbars

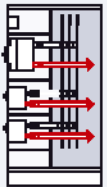

**Form 3a**  
Separation of the busbars from the functional units, separation of the terminals for external conductors from the functional units and separation of all the functional units from one another  
The terminals for external conductors do not need to be separated from the busbars

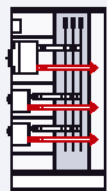

**Form 3b**  
Separation of the busbars from the functional units and separation of all the functional units from one another  
Separation of the terminals for external conductors from the functional units but not from each other  
The terminals for external conductors do not need to be separated from the busbars

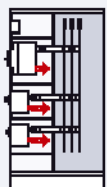

**Form 4a**  
Separation of the busbars and the functional units and separation of all the functional units from one another, including the terminals for external conductors which are an integral part of the functional unit  
The terminals for external conductors are separated from the busbars

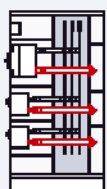

**Form 4b**  
Separation of the busbars and the functional units and separation of all the functional units from one another, including the terminals for external conductors  
The terminals for external conductors are not in the same compartment as the functional unit, but in individual, separate compartments

## Rear terminals construction

### Form 2a

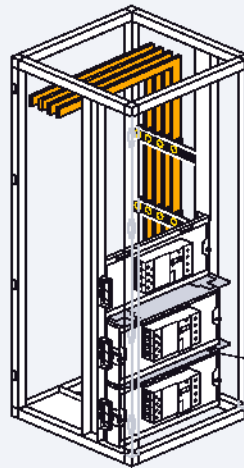

Form 2a is simply obtained by using adjustable horizontal plates  
DPX must have rear terminals  
The busbar must be installed behind the functional uprights  
If the addition of further equipment in the enclosure is required, use solid plates  
When there is a gap between 2 plates, horizontal divider  
Cat. Nos 0 208 92 or 0 205 92 must be used to prevent any contact with the rear busbar

Horizontal partitioning  
Cat.No 0 208 92 or Cat.No 0 205 92 to fill the space between the plates

### Forme 2b

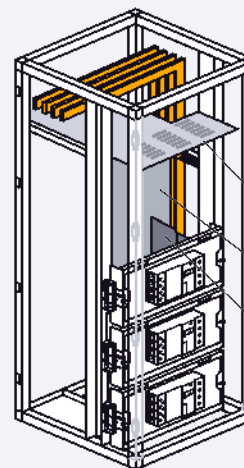

Separation of the busbars from the functional units  
The terminals for external conductors are separated from the busbars  
The vertical busbar is placed behind the functional uprights  
The devices must be horizontal and with rear terminal connection

Horizontal busbar partitioning  
Cat.No 0 208 93/94  
Horizontal rear busbars partitioning  
Cat.No 0 208 84/85  
Divider for rear terminals  
Cat.No 0 208 77/78/79

### Form 3a

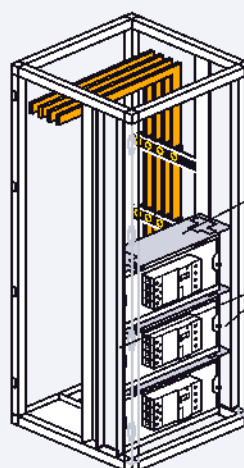

Form 3a is obtained from form 2a by adding horizontal dividers  
Cat.No 0 208 92 or Cat.No 0 205 92 and front panel total dividers  
Cat.No 0 208 90

Horizontal partitioning  
Cat.No 0 208 92 or Cat.No 0 205 92

Front panel side partitioning  
Cat.No 0 208 90



### Form 3b

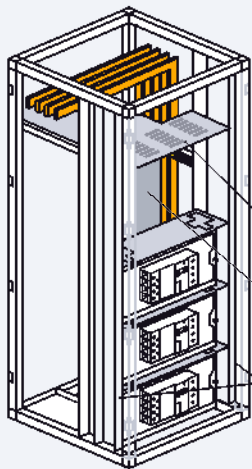

For form 3b partitioning, it is advisable to start with form 2b and add:

- Horizontal dividers between the functional units
- Side partitions either side of the functional units

- Horizontal busbar partitioning  
Cat.No 0 208 93/94
- Vertical rear busbars partitioning  
Cat.No 0 208 84/85
- Front panel side partitioning  
Cat.No 0 208 68

### Form 4b

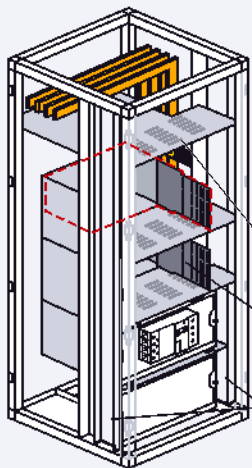

Connection on the rear terminals is obtained by using:

- Closing partitions for busbars (vertical and horizontal)
- Closing partitions for devices (horizontal and with rear terminals)
- Closing partitions for output terminals
- Closing partitions between cells that are joined together

- Horizontal busbar partitioning  
Cat.No 0 208 94
- DPX compartment kit  
Cat.No 0 208 87/88/89
- Front panel side partitioning  
Cat.No 0 208 68

## Front terminals construction

### Form 2b

The vertical busbar is positioned in a cable sleeve then separated from the functional units using a vertical separation kit between the enclosure and the cable sleeve (the cables and flexible bars can be fed through the front part)

Use an L-shaped or U-shaped separation kit for the horizontal busbars. These kits consist of a rear part (height 200 or 300 mm) and a horizontal divider across the whole of the usable depth

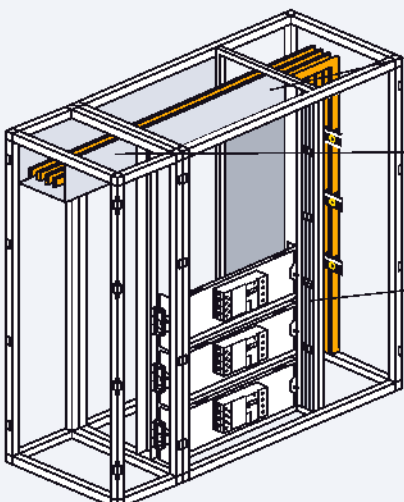

- Separation kit for horizontal busbars in enclosure  
Cat.Nos 0 205 36/37/38/39
- U-shaped separation kit for horizontal busbars in external cable sleeves  
Cat.Nos 0 208 73/74/75/86
- Vertical separation kit between enclosure or internal/external cable sleeves  
Cat.Nos 0 205 33/34/35

### Forms 3b, 4a

For form 3b partitioning, it is advisable to start with form 2b and add:

- 1 - Horizontal dividers between the functional units
- 2 - Side partitions on either side of the functional units

In 4a form, the outgoing connections must be made within the functional units

Note: When connecting via front terminals, the incoming terminals must be fitted with terminal shield MCBs

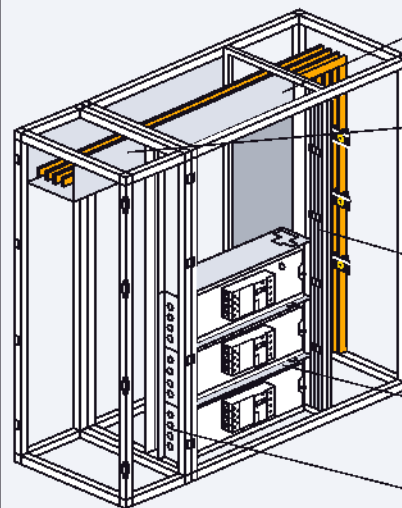

- Separation kit for horizontal busbars in enclosure  
Cat.Nos 0 205 36/37/38/39
- U-shaped separation kit for horizontal busbars in external cable sleeves  
Cat.Nos 0 208 73/74/75/86
- Vertical separation kit between enclosure or internal/external cable sleeves  
Cat.Nos 0 205 33/34/35
- Horizontal partitioning  
Cat.No 0 208 92 or  
Cat.No 0 205 92
- Side partitions with end pieces  
Cat.No 0 205 97/98/99



Technical characteristics **p. 241**

Self-extinguishing: resistance to incandescent wire 650°C. Conform to EN 60439-3. Allows to achieve assemblies conform to IEC 61 439 - 3  
 Weatherproof cabinets - IP 65 - IK 09 - Class II  
 Door and cabinet fully reversible. Removable chassis and faceplates from 2-row versions up 2-position rail for modular products and moulded cases. Spacing between rails 150 mm  
 Can be fitted with perforated plates and solid faceplates for mounting non-modular products  
 Lockable door handle, sealable cover and faceplate. Shock-resistant polystyrene material  
 Box colour light grey L750A, cover colour dark grey R746A. Supplied without terminal blocks

Pack	Cat.Nos	Cabinets 2 to 8 modules	
		Number of rows	Number of modules
6	6 019 32	1	2 (+1)
6	6 019 94	1	4
6	6 019 96	1	6
6	6 019 98	1	8

Pack	Cat.Nos	Cabinets 12 modules per row	
		Number of rows	
1	6 018 31	1	
1	6 018 32	2	
1	6 018 33	3	

Pack	Cat.Nos	Cabinets 18 modules per row	
		Number of rows	
1	6 018 35	1	
1	6 018 36	2	
1	6 018 37	3	
1	6 018 38	4	

Pack	Cat.Nos	Multifunction sleeves	
		Supplied with hinges connecting the cover to the back of the cabinet For use with 12 and 18-module cabinets using joining kit Cat.No 0 019 67 Can be fitted with control units and accessories: P17 16 A and 32 A sockets with standard fixing centres, flush-mounted IP 55 Plexo wiring accessories, Osmoz, modular rail at the back of the box	
1	0 019 17	<b>Vertical</b> For 2 rows cabinets	
1	0 019 18	For 3 rows cabinets	

Pack	Cat.Nos	Accessories	
5	0 019 71	<b>Plexo adaptor</b> For fixing Plexo flush mounting wiring accessories, complete version (p. 548) on Plexo <sup>3</sup> cabinets (minimum 2 rows)	
		<b>Installation supports for terminal blocks</b> Set of 2 supports for mounting additional terminal blocks (p. 180) or empty supports for screw terminal blocks (p. 180) into Plexo <sup>3</sup> cabinets	
1	0 019 72	For 1 and 2 rows cabinets, 12 and 18 modules per row	
1	0 019 73	For 3 and 4 rows cabinets, 12 and 18 modules per row	
1	0 019 66	<b>Key lock</b> N° 850	
1	0 019 67	<b>Joining kit</b> Allows cables to be run horizontally or vertically between 2 cabinets or multifunction sleeves while maintaining IP 65 protection	
1	0 019 68	<b>Sealing kit</b> Set of 2 sealable terminal shields for cover and 8 sealable supports for faceplate	
1	0 019 69	<b>Fixing lugs</b> Set of 4 wall mounting lugs for Plexo <sup>3</sup> boxes and P17 combined units (p. 328)	
20	0 019 61	<b>Blanking plates</b> 5, separable into modules or 1/2 module Grey R746A	
1	0 019 55	<b>Direct piercing end caps</b> Pack consisting of 2 Ø32 mm ISO end caps, 5 Ø25 mm ISO end caps and 10 Ø20 mm ISO end caps	
2	0 019 64	<b>Plain faceplates</b> For 12 modules cabinets	
2	0 019 65	For 18 modules cabinets	
2	0 019 62	<b>Perforated plates</b> Allow the DIN rail to be replaced with a LINA 25 plate when integrating non-modular products	
2	4 018 53	For 12 modules cabinets, Height 150 mm For 18 modules cabinets, Height 150 mm	
2	0 019 70	<b>Hinges</b> Set of 2 hinges connecting the back of the cabinet to the cover	



# Plexo<sup>3</sup>

## IP 65 weatherproof cabinets, multifunction sleeves and accessories

### ■ Dimensions

#### Cabinets 2, 4, 6 and 8 modules

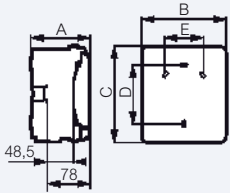

Cat.Nos	Dimensions (mm)				
	A	B	C	D	E
6 019 32	109	93	174	94	-
6 019 94	115.6	128	200	120	-
6 019 96	115.6	164	200	120	70
6 019 98	115.6	200	200	120	106

#### Cabinets 12 and 18 modules

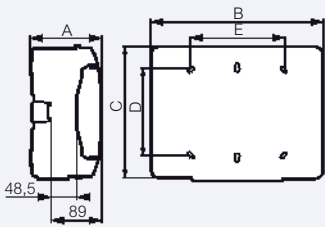

Cat.Nos	Dimensions (mm)				
	A	B	C	D	E
6 018 31	141	340	282	180	180
6 018 32	161	340	432	330	180
6 018 33	161	340	622	480	180
6 018 35	141	448	282	180	288
6 018 36	161	448	432	330	290
6 018 37	161	448	622	480	290
6 018 38	161	448	822	680	290

### ■ Vertical multifunction sleeves

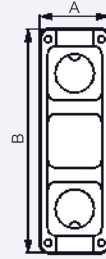

Cat.No	Dimensions (mm)		Number of positions
	A	B	
0 019 17	137	432	3
0 019 18	137	622	4

### ■ Number of knockouts on each side

Cat.Nos	Top/bottom			Left/right		
	Ø20 mm	Ø25 mm	Ø32 mm	Ø20 mm	Ø25 mm	Ø32 mm
6 019 32	2	-	-	-	-	-
6 019 94	2	1	-	2	-	-
6 019 96	4	1	-	2	-	-
6 019 98	6	1	-	2	-	-
6 018 31	7	2	2	-	-	2
6 018 32	13	2	2	-	-	3
6 018 33	13	2	2	-	-	4
6 018 35	12	2	3	-	-	2
6 018 36	13	4	3	-	-	3
6 018 37	13	4	3	-	-	4
6 018 38	13	4	3	-	-	5

# Atlantic, Atlantic-E and Marina: cabinets and equipment selection chart

EXTERNAL DIMENSIONS				ATLANTIC CABINETS (p. 244)	ATLANTIC-E CABINETS (p. 248)	MARINA CABINETS (p. 250)		
				METAL IP 66 - IK 10 (1 door) IP 55 - IK 10 (2 doors)	METAL IP 66 - IK 10		POLYESTER - IP 66 - IK 10	
				RAL 7035	RAL 7035	RAL 2000	RAL 7035	RAL 7035 with glass door
Shapes	H (mm)	W (mm)	D (mm)					
	300	200	150		0 399 30	9 003 86		
	400	300	150		0 399 34			
	400	300	160	0 355 09 <sup>(1)</sup>				
	500	400	150		0 399 38			
	300	200	160	0 355 00 <sup>(1)</sup> supplied with plain plate			0 362 50	
	400	300	200	0 355 02	0 399 35	9 003 87	0 362 51	0 362 71
	500	400	200	0 355 03	0 399 39	9 003 88	0 362 52	0 362 72
	600	400	200	0 355 04	0 399 42	9 003 89		
	600	500	200		0 399 44	9 003 91		
	700	500	200		0 399 51			
	800	600	200		0 399 54			
	500	400	250	0 355 07	0 399 40			
	600	400	250	0 355 08	0 399 43	9 003 90	0 362 55	0 362 75
	600	500	250		0 399 45			
	700	500	250	0 355 12	0 399 52	9 003 92	0 362 56	0 362 76
	800	600	250	0 355 14	0 399 55	9 003 93		
	1000	600	250	0 355 17				
	1000	800	250	0 355 18	0 399 64			
	700	500	300	0 355 22				
	800	600	300	0 355 23	0 399 56	9 003 94	0 362 61	0 362 81
	1000	600	300	0 355 26	0 399 63			
	1000	800	300	0 355 27	0 399 65	9 003 95	0 362 63	0 362 83
	1200	800	300	0 355 92	0 399 69		0 362 64	0 362 84
	1200	1000	300	0 355 93 <sup>(2)</sup>				
1400	1000	300	0 355 95 <sup>(2)</sup>					
	800	600	400	0 355 28				
	1000	800	400	0 355 29				
	1200	800	400	0 355 96				
	1400	800	400	0 355 98				
	300	300	150		0 399 31			
	300	300	160	0 355 05 <sup>(1)</sup>				
	300	300	200	0 355 30	0 399 32			
	400	400	200	0 355 31	0 399 36			
	500	500	250	0 355 32	0 399 41			
	600	600	250	0 355 10	0 399 46			
	800	800	250	0 355 15				
	600	600	300	0 355 20				
800	800	300	0 355 24	0 399 59				
1000	1000	300	0 355 91 <sup>(2)</sup>					
1200	1200	300	0 355 94 <sup>(2)</sup>					
600	600	400	0 355 36					
1200	1200	400	0 355 97 <sup>(2)</sup>					
	300	400	200	0 355 01	0 399 33			
	400	600	250	0 355 06	0 399 37			
	800	1000	250	0 355 33 <sup>(2)</sup>				
	600	800	300	0 355 21 <sup>(2)</sup>				
	600	1000	300	0 355 37 <sup>(2)</sup>				
	800	1000	300	0 355 34 <sup>(2)</sup>				
1000	1200	300	0 355 90 <sup>(2)</sup>					

1: Without cable entries plate - 2: 2 doors - 3: Usable area: 800 x 640 mm - 4: Crosspieces to be cut (2 m height) can be used for cabinets width 1000 and 1200 (see p. 258)

**EQUIPMENT (p. 256)**

Plain plates	Lina 12.5 plates	Perforated plates Lina 25	Sectionned uprights Lina 25	Crosspieces rails	Insulated modular chassis	Internal doors (+Cat.No 0 363 69 for mounting on Atlantic metal cabinets)	Roofs	Plinths	IP 55 Cabstop plate Direct mounting on Atlantic cabinet opening <sup>(5)</sup>
	0 360 00	0 360 07	0 361 50	-	-	-	-	-	-
0 360 52	0 360 04	0 360 12	0 361 51	0 367 80	-	-	-	-	-
0 360 52	0 360 04	0 360 12	0 361 51	0 367 80	-	0 363 59 <sup>(A)(M)</sup>	-	-	-
	0 360 09	0 360 15	0 361 52	0 367 81	-	-	-	-	-
0 360 49 <sup>(M)</sup>	0 360 00 <sup>(A)</sup> 0 360 01 <sup>(M)</sup>	0 360 07 <sup>(A)</sup> 0 360 99 <sup>(M)</sup>	0 361 50 <sup>(A)</sup>						
0 360 52	0 360 04	0 360 12	0 361 51	0 367 80	0 361 01	0 363 59 <sup>(A)(M)</sup>	0 365 51 <sup>(A)(E)</sup>		0 364 94 <sup>(A)</sup>
0 360 55	0 360 09	0 360 15	0 361 52	0 367 81	0 361 02	0 363 60 <sup>(A)(M)</sup>	0 365 52 <sup>(A)(E)</sup>		0 364 95
0 360 56	0 360 22	0 360 16	0 361 53	0 367 81		0 363 61 <sup>(A)(M)</sup>	0 365 52 <sup>(A)(E)</sup>		0 364 95
		-	0 361 53	0 367 82					0 364 95
	0 360 31	0 360 18	0 361 54	0 367 82					0 364 95
	0 360 33	0 360 19	0 361 55	0 367 83					0 364 95
0 360 55	0 360 09	0 360 15	0 361 52	0 367 81		0 363 60 <sup>(A)(M)</sup>	0 365 53 <sup>(A)(E)</sup>		0 364 95
0 360 56	0 360 22	0 360 16	0 361 53	0 367 81	0 361 03	0 363 61 <sup>(A)(M)</sup>	0 365 53 <sup>(A)(E)</sup>		0 364 95
		-	0 361 53	0 367 82			0 365 64 <sup>(A)(E)</sup>		0 364 95
0 360 58	0 360 31	0 360 18	0 361 54	0 367 82	0 361 05	0 363 62 <sup>(A)(M)</sup>	0 362 93 <sup>(M)</sup> 0 365 64 <sup>(A)(E)</sup>		0 364 95 <sup>(E)</sup> 0 364 96 <sup>(A)</sup>
0 360 59	0 360 33	0 360 19	0 361 55	0 367 83		0 363 63 <sup>(A)(M)</sup>	0 365 54 <sup>(A)(E)</sup>		0 364 97
0 360 54	0 360 40	0 360 23	0 361 56	0 367 83					0 364 97
0 360 61	0 360 42	0 360 21	0 361 56	0 367 84		0 363 64 <sup>(A)(M)</sup>			0 364 97
0 360 58	0 360 31	0 360 18	0 361 54	0 367 82		0 363 62 <sup>(A)(M)</sup>			0 364 96
0 360 59	0 360 33	0 360 19	0 361 55	0 367 83	0 361 06	0 363 63 <sup>(A)(M)</sup>	0 362 94 <sup>(M)</sup> 0 365 56 <sup>(A)(E)</sup>	0 362 91 <sup>(M)</sup> 0 363 00 <sup>(E)</sup>	0 364 97
0 360 54	0 360 40	0 360 23	0 361 56	0 367 83			0 365 56 <sup>(A)(E)</sup>	0 363 00 <sup>(E)</sup>	0 364 97
0 360 61	0 360 42	0 360 21	0 361 56	0 367 84	0 361 09	0 363 64 <sup>(A)(M)</sup>	0 362 95 <sup>(M)</sup> 0 365 57 <sup>(A)(E)</sup>	0 362 92 0 363 00 <sup>(E)</sup>	0 364 97
0 360 64	0 360 46	0 360 87	0 361 58	0 367 84	0 361 10	0 363 65 <sup>(A)(M)</sup>	0 362 95 <sup>(M)</sup> 0 365 57 <sup>(A)(E)</sup>	0 362 92 0 363 01 <sup>(E)</sup>	0 364 97
0 360 65	0 360 47	0 360 88	0 361 58	<sup>(4)</sup>					2 x 0 364 96
0 360 68	0 360 79	0 360 98	0 361 59	<sup>(4)</sup>					2 x 0 364 96
0 360 59	0 360 33	0 360 19	0 361 55	0 367 83		0 363 63 <sup>(A)(M)</sup>			0 364 97
0 360 61	0 360 42	0 360 21	0 361 56	0 367 84		0 363 64 <sup>(A)(M)</sup>			0 364 97
0 360 64	0 360 46	0 360 87	0 361 58	0 367 84		0 363 65 <sup>(A)(M)(3)</sup>			0 364 97
0 360 67	0 360 75	0 360 90	0 361 59	0 367 84					0 364 97
0 360 69	0 360 02	0 360 91	0 361 50	0 367 80					-
0 360 69	0 360 02	0 360 91	0 361 50	0 367 80					-
0 360 69	0 360 02	0 360 91	0 361 50	0 367 80			0 365 51 <sup>(A)(E)</sup>		0 364 94
0 360 70	0 360 05	0 360 92	0 361 51	0 367 81			0 365 52 <sup>(A)(E)</sup>		0 364 95
0 360 71	0 360 14	0 360 93	0 361 52	0 367 82			0 365 64 <sup>(A)(E)</sup>		0 364 95 <sup>(E)</sup> 0 364 96 <sup>(A)</sup>
0 360 57	0 360 24	0 360 17	0 361 53	0 367 83			0 365 54 <sup>(A)(E)</sup>		0 364 97
0 360 60	0 360 34	0 360 20	0 361 55	0 367 84					0 364 97
0 360 57	0 360 24	0 360 17	0 361 53	0 367 83					0 364 97
0 360 60	0 360 34	0 360 20	0 361 55	0 367 84			0 365 57 <sup>(A)(E)</sup>	0 363 01 <sup>(E)</sup>	0 364 97
0 360 63	0 360 43	0 360 25	0 361 56	<sup>(4)</sup>					2 x 0 364 96
0 360 66	0 360 48	0 360 89	0 361 58	<sup>(4)</sup>					2 x 0 364 97
0 360 57	0 360 24	0 360 17	0 361 53	0 367 83					0 364 97
0 360 66	0 360 48	0 360 89	0 361 58	<sup>(4)</sup>					2 x 0 364 97
0 360 52	0 360 04	0 360 11	0 361 50	0 367 81			0 365 52 <sup>(A)(E)</sup>		0 364 95
0 360 56	0 360 22	0 360 13	0 361 51	0 367 83			0 365 54 <sup>(A)(E)</sup>		0 364 97
0 360 61	0 360 42	0 360 94	0 361 55	<sup>(4)</sup>					2 x 0 364 96
0 360 59	0 360 33	0 360 06	0 361 53	0 367 84					0 364 97
0 360 54	0 360 40	0 360 08	0 361 53	<sup>(4)</sup>					2 x 0 364 96
0 360 61	0 360 42	0 360 94	0 361 55	<sup>(4)</sup>					2 x 0 364 96
0 360 65	0 360 47	0 360 10	0 361 56	<sup>(4)</sup>					2 x 0 364 97

**ADDITIONAL PRODUCTS**

**Hinged glass doors**  
(p. 258)

**Kit Cat.No 0 364 98**  
for mounting  
Cabstop plate on plain  
surface (p. 245)

**Document pockets**  
(p. 258)

**Colring cable ties**  
(p. 272)

**Heat regulation**  
(p. 262)

**19" wall mounting chassis**  
(p. 258)

**Floor fixing with stands**  
(p. 251)

**Locking accessories**  
(p. 260)

**Marina enclosures**  
**RAL 7035**  
**IP 66 - IK 10** (p. 252)

5: Use kit Cat.No 0 364 98 (p. 245) for direct mounting on Marina cabinets - (A) For Atlantic - (E) For Atlantic-E - (M) For Marina

# Atlantic metal cabinets

IP 55/IP 66 - IK 10 - Nema 4x - Nema 12



0 355 23



0 355 37

Cabinet and equipment selection chart **p. 256**  
 Technical characteristics **p. 257**

IP 66 according to standards IEC EN 60529 for 1 doors cabinets  
 IP 55 according to standards IEC EN 60529 for 2 doors cabinets  
 IK 10 according to standards IEC EN 62262  
 LCIE 17 07 90 10A  
 Nema 4x, 1 door, Nema 12, 2 doors - UL, CSA, Bureau Veritas, TÜV agreements  
 EMC attenuation 20 dB (for an EMC attenuation from 40 to 50 dB at 1 GHz, please consult us)  
 Excellent resistance to corrosion and chemical agents  
 80 µm thick textured polyester coating. Anti-corrosion treatment for hinges and axis  
 Reversible door - One locking point. Locking with key 2433 A (2 keys supplied)  
 Up to 300 mm height, fitted with latch for height upper than 300 mm, fitted with lever  
 Low cable entries RAL 7035  
 Optional depth regulation for cabinets 400 mm depth Cat.No 0 367 45 (p. 245)

Pack	Cat.Nos	Metal cabinets vertical version		
		External dimensions (mm) Height x Width x Depth	Number of doors	Weight (kg)
1	0 355 00 <sup>1</sup>	300 x 200 x 160	1	4.2
1	0 355 09 <sup>2</sup>	400 x 300 x 160	1	6.3
1	0 355 02	400 x 300 x 200	1	6.5
1	0 355 03	500 x 400 x 200	1	9.7
1	0 355 04	600 x 400 x 200	1	10.7
1	0 355 07	500 x 400 x 250	1	10.7
1	0 355 08	600 x 400 x 250	1	12
1	0 355 12	700 x 500 x 250	1	16.5
1	0 355 14	800 x 600 x 250	1	18.8
1	0 355 17	1000 x 600 x 250	1	24
1	0 355 18	1000 x 800 x 250	1	36.4
1	0 355 22	700 x 500 x 300	1	23
1	0 355 23	800 x 600 x 300	1	28.8
1	0 355 26	1000 x 600 x 300	1	33.3
1	0 355 27	1000 x 800 x 300	1	42
1	0 355 92	1200 x 800 x 300	1	49.6
1	0 355 93	1200 x 1000 x 300	2	62.2
1	0 355 95	1400 x 1000 x 300	2	71
1	0 355 28	800 x 600 x 400	1	31
1	0 355 29	1000 x 800 x 400	1	45
1	0 355 96	1200 x 800 x 400	1	57
1	0 355 98	1400 x 800 x 400	1	64

		Metal cabinets square version		
		External dimensions (mm) Height x Width x Depth	Number of doors	Weight (kg)
1	0 355 05 <sup>2</sup>	300 x 300 x 160	1	4.1
1	0 355 30	300 x 300 x 200	1	4.2
1	0 355 31	400 x 400 x 200	1	7.7
1	0 355 32	500 x 500 x 250	1	11.5
1	0 355 10	600 x 600 x 250	1	16.3
1	0 355 15	800 x 800 x 250	1	21.6
1	0 355 20	600 x 600 x 300	1	21.1
1	0 355 24	800 x 800 x 300	1	34.2
1	0 355 91	1000 x 1000 x 300	2	53
1	0 355 94	1200 x 1200 x 300	2	70
1	0 355 36	600 x 600 x 400	1	28
1	0 355 97	1200 x 1200 x 400	2	77

Pack	Cat.Nos	Metal cabinets horizontal version		
		External dimensions (mm) Height x Width x Depth	Number of doors	Weight (kg)
1	0 355 01	300 x 400 x 200	1	6.5
1	0 355 06	400 x 600 x 250	1	11.7
1	0 355 33	800 x 1000 x 250	2	27
1	0 355 21	600 x 800 x 300	2	28.8
1	0 355 37	600 x 1000 x 300	2	32
1	0 355 34	800 x 1000 x 300	2	33.3
1	0 355 90	1000 x 1200 x 300	2	62.2

**Roofs RAL 7035**

Steel  
 Possible adjustment ± 20 mm (front or back)

Pack	Cat.Nos	For cabinets		Weight (kg)
		Width (mm)	Depth (mm)	
1	0 365 51	300	200	1.2
1	0 365 52	400	200	1.4
1	0 365 53	400	250	1.8
1	0 365 64	500	250	2
1	0 365 54	600	250	2.5
1	0 365 56	600	300	3
1	0 365 57	800	300	3.6

Pack	Cat.Nos	Lighting kit
1	0 363 12	Supplied with 8 W fluorescent tube, Ø16 mm 230 V - 50 Hz Class I - IP 20 - 600 lumens Electromagnetic compatibility according to EN 55015 Equipped with a switch Connection on terminal block Dim.: 320 x 61 x 32 mm

1: With no opening supplied with plain plates  
 2: With no opening

Door contact  
**p. 258**

Plain plates, Lina 12.5 and Lina 25  
 perforated plates, **p. 256**



## Equipment for Atlantic metal cabinets



0 355 93 with Cabstop plate Cat.No 0 364 96 and mounting kit Cat.No 0 364 98



0 367 35 with rail Cat.No 0 367 82 (p. 258)



0 347 95



Touch-up brush 0 365 91



0 364 01



0 329 46



0 329 47



0 364 04

Cabinet and equipment selection chart p. 242-243  
Technical characteristics p. 246

Pack	Cat.Nos	<b>Cabstop open-work plate IP 55</b>																				
		<p>Cable entries consisting of a cable clamp providing the mechanical grip, and elastomer areas for weatherproofing Can be pierced using the cable (no tool required) Fits the cable perfectly Replacement of a cable possible Fire retardant polypropylene RAL 7035 2 possibilities of mounting: - direct on cable entry of Atlantic, Atlantic-E or Marina cabinets - on flat surface with kit Cat.No 0 364 98 Supplied with: - locking caps for sealing a pierced entry providing IP 55 protection - cable release tool</p> <table border="1"> <thead> <tr> <th>Number of entries Ø5 to 14</th> <th>Number of entries Ø14 to 24</th> <th>Number of spare entries</th> <th>Direct mounting on cable entry of cabinet width (mm)</th> </tr> </thead> <tbody> <tr> <td>13</td> <td>1</td> <td>-</td> <td>300</td> </tr> <tr> <td>13</td> <td>1</td> <td>1</td> <td>400</td> </tr> <tr> <td>28</td> <td>2</td> <td>1</td> <td>500-1000</td> </tr> <tr> <td>28</td> <td>2</td> <td>2</td> <td>600-800-1200</td> </tr> </tbody> </table> <p>Kit for mounting Cabstop plate on plain plate Enables mounting of 2 Cabstop plates: Cat.Nos 0 364 94 or 95 and 0 364 96 or 97 IP 55 maintained</p>	Number of entries Ø5 to 14	Number of entries Ø14 to 24	Number of spare entries	Direct mounting on cable entry of cabinet width (mm)	13	1	-	300	13	1	1	400	28	2	1	500-1000	28	2	2	600-800-1200
Number of entries Ø5 to 14	Number of entries Ø14 to 24	Number of spare entries	Direct mounting on cable entry of cabinet width (mm)																			
13	1	-	300																			
13	1	1	400																			
28	2	1	500-1000																			
28	2	2	600-800-1200																			
1	0 364 94																					
1	0 364 95																					
1	0 364 96																					
1	0 364 97																					
1	0 364 98																					

Pack	Cat.Nos	<b>Cable entries for Atlantic cabinets 600 or 800 mm width</b>
1	0 329 46	IP 43 cable entry plate with brush (cable feed-through 385 x 30 mm)
1	0 329 47	IP 55 multi-entry cable entry plate with cable glands Supplied with 12 ISO 32 cable glands The cable glands take 4 UTP/FTP/SFTP cables (Ø6.5 to 9.5 mm) per cable gland Cords with connectors can be fed through without having to dismantle the cable gland Usable interior Ø25.5 mm Supplied with blanking plates for unused entries

Pack	Cat.Nos	<b>Protective conductor</b>																		
		<p><b>Earth braid</b></p> <table border="1"> <thead> <tr> <th>Capacity (mm<sup>2</sup>)</th> <th>Fixing spacing (mm)</th> <th>Ø of holes (mm)</th> </tr> </thead> <tbody> <tr> <td>6</td> <td>200</td> <td>8.5</td> </tr> <tr> <td>16</td> <td>200</td> <td>8.5</td> </tr> <tr> <td>30</td> <td>200</td> <td>8.5</td> </tr> </tbody> </table> <p><b>Green/yellow wire</b></p> <table border="1"> <thead> <tr> <th>Capacity (mm<sup>2</sup>)</th> <th>Fixing spacing (mm)</th> <th>Ø of holes (mm)</th> </tr> </thead> <tbody> <tr> <td>6</td> <td>200</td> <td>6.5</td> </tr> </tbody> </table>	Capacity (mm <sup>2</sup> )	Fixing spacing (mm)	Ø of holes (mm)	6	200	8.5	16	200	8.5	30	200	8.5	Capacity (mm <sup>2</sup> )	Fixing spacing (mm)	Ø of holes (mm)	6	200	6.5
Capacity (mm <sup>2</sup> )	Fixing spacing (mm)	Ø of holes (mm)																		
6	200	8.5																		
16	200	8.5																		
30	200	8.5																		
Capacity (mm <sup>2</sup> )	Fixing spacing (mm)	Ø of holes (mm)																		
6	200	6.5																		
20	0 347 95																			
20	0 347 96																			
10	0 347 97																			
20	0 363 95																			
		<p><b>Paint touch-up</b></p> <p><b>Aerosol paint spray</b> RAL 7035</p> <p><b>Touch-up brush</b> For protecting the sheet metal after cutting Anti-corrosion paint</p>																		
1	0 365 97																			
10	0 365 91																			
		<p><b>Temporary marking</b> Water-soluble marker pen</p>																		
10	0 395 99																			
		<p><b>Accessories</b></p> <p><b>Set of 4 slides for depth adjustment</b> For 400 mm depth cabinets</p> <p><b>Wall-mounting lugs (set of 4)</b> For load up to 300 kg Horizontal or vertical installation With a roof, horizontal installation only Zamak RAL 7035 Supplied with cover finish</p> <p><b>Attachment lugs for rail</b>  Supplied with M6 screws Set of 2 Used to attach the 15 mm depth symmetric rail  on door profile strand-holder</p>																		
1	0 367 45																			
1	0 364 01																			
1	0 364 04																			
5	0 367 35																			

# Atlantic metal cabinets

IP 55/IP 66 - IK 10 - Nema 4x - Nema 12

## Usable dimensions

### Doors

2 doors

1 door

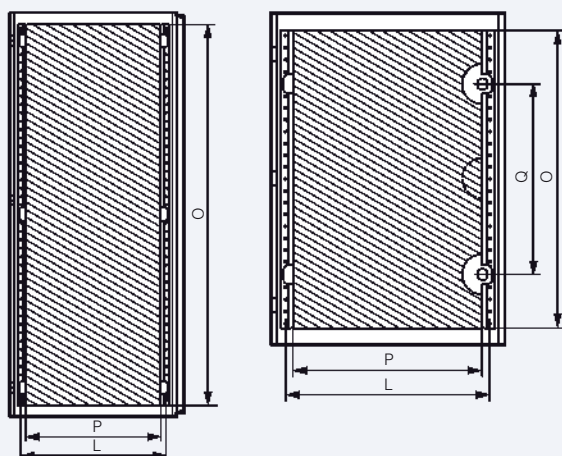

Cat.Nos	Cabinets		Door usable dimensions		Lock positions Q (mm)	Strand-holder fixing centres L (mm)
	Height (mm)	Width (mm)	Height O (mm)	Width P (mm)		
0 355 00	300	200	251	148	(1)	(3)
0 355 05/30	300	300	251	248	(1)	(3)
0 355 01	300	400	251	348	(1)	(3)
0 355 02/09	400	300	351	248	(1)	(3)
0 355 31	400	400	351	348	(1)	(3)
0 355 06	400	600	325	500	(1)	530
0 355 03/07	500	400	425	300	(1)	330
0 355 32	500	500	425	400	(1)	430
0 355 04/08	600	400	525	300	350(2)	330
0 355 10/20/36	600	600	525	500	350(1)	530
0 355 21	600	800	525	300 x 2	(1)	330
0 355 37	600	1000	525	400 x 2	(1)	430
0 355 12/22	700	500	625	400	400(2)	430
0 355 14/23/28	800	600	725	500	500(2)	530
0 355 15/24	800	800	725	700	500(2)	730
0 355 33/34	800	1000	725	400 x 2	(1)	430
0 355 17/26	1000	600	925	500	(1)	530
0 355 18/27/29	1000	800	925	700	(1)	730
0 355 91	1000	1000	925	400 x 2	(1)	430
0 355 90	1000	1200	925	500 x 2	(1)	530
0 355 92/96	1200	800	1125	700	(1)	730
0 355 93	1200	1000	1125	400 x 2	(1)	430
0 355 94/97	1200	1200	1125	500 x 2	(1)	530
0 355 98	1400	800	1325	700	(1)	730
0 355 95	1400	1000	1325	400 x 2	(1)	430

- 1: Central lock
- 2: Top and bottom lock
- 3: Without strand-holder

Fixing on door of a symmetrical rail depth 15 mm with Cat.No 0 367 35

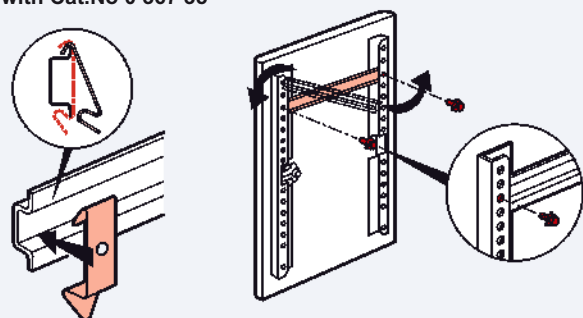

### Usable depth

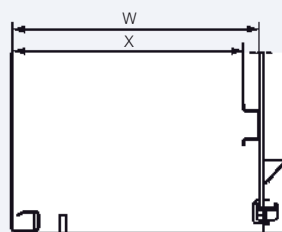

Cabinets Depth (mm)	Back of cabinet	
	W (mm)	X (mm)
160	140	125
200	180	165
250	230	215
300	280	265
400	380	365

### Adjustment of equipment (optional) with slides

Cat.No 0 367 45  
For 400 mm depth cabinets

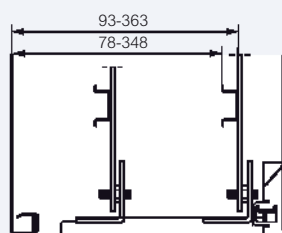

### Cable entries

Cabinets width ≤ 800 mm

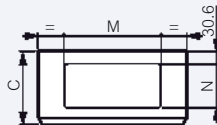

Cabinets width ≥ 1000 mm

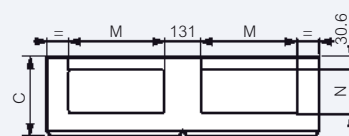

Cabinets (mm)		Dimensions of cable entries (mm)		
Width	Depth	C	M	N
200	160	170	-	-
300	200	210	169	115
400	200	210	269	115
400	250	260	269	115
500	250	260	369	150
500	300	310	369	150
600	250	260	469	150
600	300	310	469	150
600	400	410	469	150
800	250	260	469	150
800	300	310	469	150
800	400	410	469	150
1000	250	260	369	150
1000	300	310	369	150
1200	300	310	469	150
1200	400	410	469	150



### Usable dimensions

#### Fixing

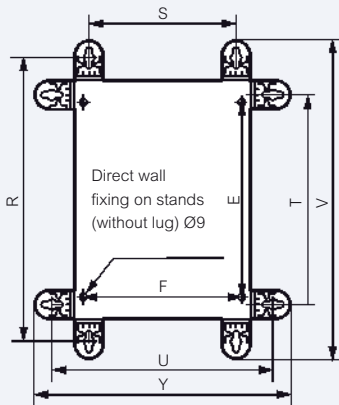

Cat.No 0 364 01

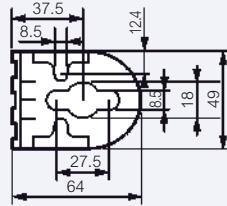

Cat.No 0 364 04

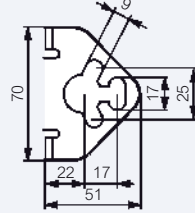

Cabinets		Vertical lugs		Mounting centres		Horizontal lugs		Mounting centres		Overall 0 364 01		Overall 0 364 04	
H (mm)	W (mm)	R (mm)	S <sup>(1)</sup> (mm)	E (mm)	T <sup>(1)</sup> (mm)	U (mm)	F (mm)	V (mm)	Y (mm)	V (mm)	Y (mm)	V (mm)	Y (mm)
300	200	375	150	225	250	275	169	430	330	402	302		
300	300	375	250	225	250	375	269	430	430	402	402		
300	400	375	350	225	250	475	369	430	530	402	502		
400	300	475	250	325	350	375	269	530	430	502	402		
400	400	475	350	325	350	475	369	530	530	502	502		
400	600	475	550	325	350	675	569	530	730	502	702		
500	400	575	350	425	450	475	369	630	530	602	502		
500	500	575	450	425	450	575	469	630	630	602	602		
600	400	675	350	525	550	475	369	730	530	702	502		
600	600	675	550	525	550	675	569	730	730	702	702		
600	800	675	750	525	550	875	769	730	930	702	902		
600	1000	675	950	525	550	1075	969	730	1130	702	1102		
700	500	775	450	625	650	575	469	830	630	802	602		
800	600	875	550	725	750	675	569	930	730	902	702		
800	800	875	750	725	750	875	769	930	930	902	902		
800	1000	875	950	725	750	1075	969	930	1130	902	1102		
1000	600	1075	550	925	950	675	569	1130	730	1102	702		
1000	800	1075	750	925	950	875	769	1130	930	1102	902		
1000	1000	1075	950	925	950	1075	969	1130	1130	1102	1102		
1000	1200	1075	1150	925	950	1275	1169	1130	1330	1102	1302		
1200	800	1275	750	1125	1150	875	769	1330	930	1302	902		
1200	1000	1275	950	1125	1150	1075	969	1330	1130	1302	1102		
1200	1200	1275	1150	1125	1150	1275	1169	1330	1330	1302	1302		
1400	800	1475	750	1325	1350	875	769	1530	930	1502	902		
1400	1000	1475	950	1325	1350	1075	969	1530	1130	1502	1102		

1: Same mounting centres for Cat.Nos 0 364 01 and 0 364 04

### Assembly kit on plane surface for Cabstop plate

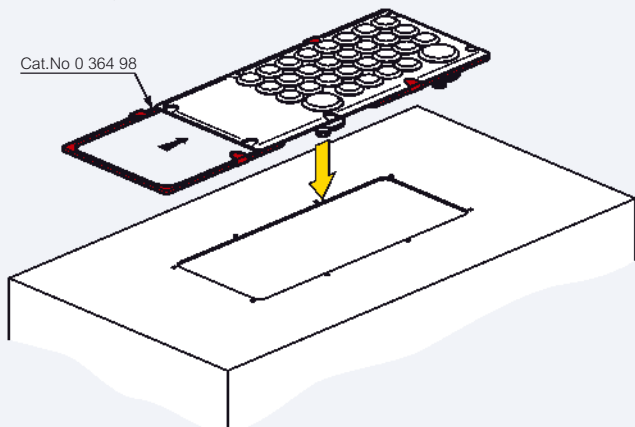

### Cabstop plate

- Tensile resistance: 15 kg minimum
- Operating temperature: - 20 °C to + 65 °C
- ASTM No 3 resistance to cutting oil
- Resistance to incandescent wire: 750 °C according to IEC EN 60695-2-11

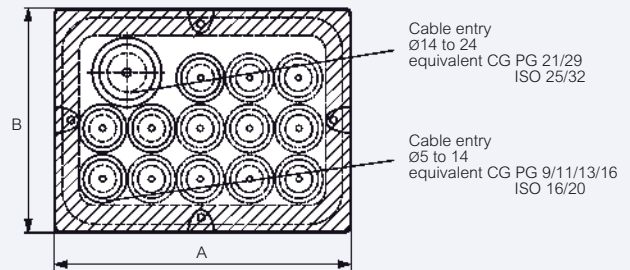

#### Dimensions

Cat.No 0 364 94

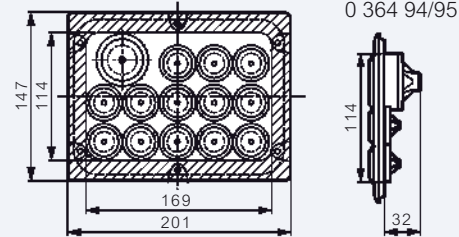

Cat.No 0 364 95

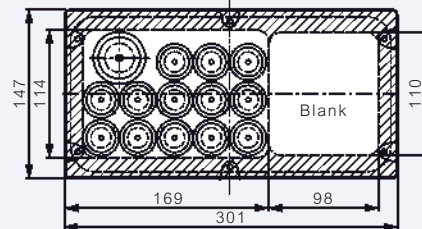

Cat.No 0 364 96

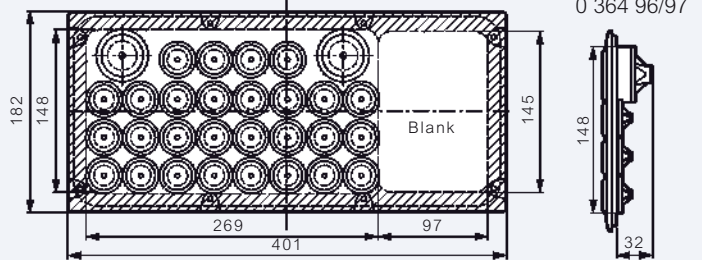

Cat.No 0 364 97

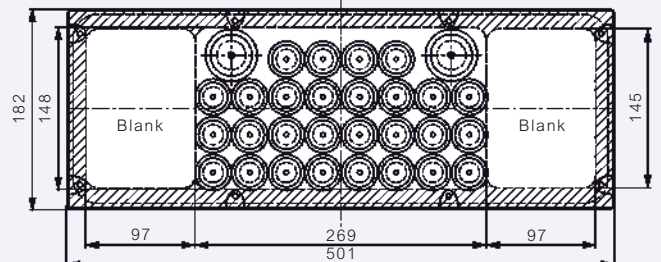

# Atlantic-E weatherproof metal cabinets

IP 66 - IK 10



Cabinet and equipment selection chart **p. 242-243**  
 Technical characteristics **p. 249**

Pack	Cat.Nos	Metal cabinets			
		IP 66 - IK 10 according to IEC EN 60529 Supplied with: galvanized plain mounting plate (removable), earth connection braid and wall mounting lugs Reversible door Supplied with one double bar lock up to 500 x 500 x 250 mm and 2 double bar lock from 600 x 400 x 150 mm Removable cable entries plate Can be equipped with Cabstop plates (p. 245) Can be equipped with Lina 12.5 and Lina 25 perforated plates, sectionned uprights, DIN rail or chassis with insulating faceplates (p. 256, 258, 259) 80 µ thick textured polyester coating			
		Grey RAL 7035			
		Height	Dimensions (mm)		Weight (kg)
			Width	Depth	
1	0 399 30	300	200	150	4.5
1	0 399 31	300	300	150	4.7
1	0 399 32	300	300	200	4.8
1	0 399 33	300	400	200	6.7
1	0 399 34	400	300	150	6.25
1	0 399 35	400	300	200	6.7
1	0 399 36	400	400	200	10.5
1	0 399 37	400	600	250	13.5
1	0 399 38	500	400	150	11
1	0 399 39	500	400	200	11.5
1	0 399 40	500	400	250	12
1	0 399 41	500	500	250	12.5
1	0 399 42	600	400	200	13
1	0 399 43	600	400	250	13.5
1	0 399 44	600	500	200	16
1	0 399 45	600	500	250	16.5
1	0 399 46	600	600	250	17
1	0 399 51	700	500	200	20
1	0 399 52	700	500	250	21
1	0 399 54	800	600	200	27
1	0 399 55	800	600	250	30
1	0 399 56	800	600	300	31.7
1	0 399 59	800	800	300	33.5
1	0 399 63	1000	600	300	48
1	0 399 64	1000	800	250	49.5
1	0 399 65	1000	800	300	52
1	0 399 69	1200	800	300	62
		Orange RAL 2000			
1	9 003 86	300	200	150	4.5
1	9 003 87	400	300	200	6.7
1	9 003 88	500	400	200	11.5
1	9 003 89	600	400	200	13
1	9 003 90	600	400	250	13.5
1	9 003 91	600	500	200	16
1	9 003 92	700	500	250	21
1	9 003 93	800	600	250	30
1	9 003 94	800	600	300	31.7
1	9 003 95	1000	800	300	52

Pack	Cat.Nos	Plinths RAL 7021		
		Height 200 mm Front and rear trap door		
		For cabinets		
		Width (mm)	Depth (mm)	Weight (kg)
1	0 363 00	600	300	6
1	0 363 01	800	300	6.7

Roofs RAL 7035				
		Steel		
		Possible adjustment ± 20 mm (front or back)		
		For cabinets		
		Width (mm)	Depth (mm)	Weight (kg)
1	0 365 51	300	200	1.2
1	0 365 52	400	200	1.4
1	0 365 53	400	250	1.8
1	0 365 64	500	250	2
1	0 365 54	600	250	2.5
1	0 365 56	600	300	3
1	0 365 57	800	300	3.6

Wall mounting lugs (set of 4)	
1	0 364 01
For load up to 300 kg Horizontal or vertical installation With a roof, horizontal installation only Zamak RAL 7035 Supplied with cover finish	

Lighting kit	
1	0 363 12
Supplied with 8 W fluorescent tube, Ø16 mm 230 V - 50 Hz Class I - IP 20 - 600 lumens Electromagnetic compatibility according to EN 55015 Equipped with a switch Connection on terminal block Dim.: 320 x 61 x 32 mm	

Metal rebate locks	
10	0 399 80
10	0 399 81
Square female 6 mm Triangle male 8 mm	

Key barrels	
Supplied with set of 2 keys For key No	
10	0 399 86
10	0 399 87
10	0 399 88
10	0 365 45
405 455 2433 A Set of two 2433 A keys	

Metal keys for rebate locks	
10	0 365 35
10	0 365 40
Square female 6 mm Triangle male 8 mm	



# Atlantic-E weatherproof metal cabinets

IP 66 - IK 10

## Doors: dimensions usable area

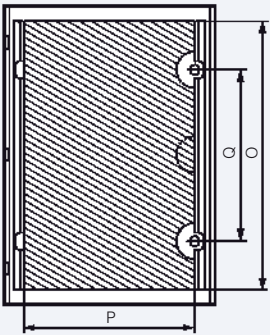

Enclosures H x W (mm)	Door usable space			Locking position Q (mm)
	Height O (mm)	Width P (mm)	Area (dm <sup>2</sup> )	
300 x 200	251	80	2.0	(1)
300 x 300	251	180	4.5	(1)
300 x 400	251	280	7.0	(1)
400 x 300	351	180	6.3	(1)
400 x 400	351	280	9.8	(1)
400 x 600	351	480	16.8	(1)
500 x 400	425	280	11.9	(1)
500 x 500	425	380	16.1	(1)
600 x 400	525	280	14.7	350 <sup>(2)</sup>
600 x 500	525	380	19.9	350 <sup>(2)</sup>
600 x 600	525	480	25.2	350 <sup>(2)</sup>
700 x 500	625	380	23.7	450 <sup>(2)</sup>
800 x 600	725	480	36.0	550 <sup>(2)</sup>
800 x 800	725	680	49.3	550 <sup>(2)</sup>
1000 x 600	925	480	44.4	750 <sup>(2)</sup>
1000 x 800	925	680	62.9	750 <sup>(2)</sup>
1200 x 800	1125	680	76.5	950 <sup>(2)</sup>

1: Central lock  
2: Top and bottom lock

## Cable entry plate

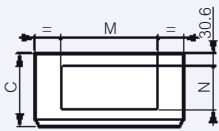

Cabinets (mm)			Dimensions of cable entries (mm)		
W	D	Overall depth C	M	N	
200	150	155	116.5	62.5	
300	150	155	116.5	62.5	
300	200	205	116.5	62.5	
400	150	155	116.5	62.5	
400	200	205	266.5	112.5	
400	250	255	266.5	112.5	
500	200	205	266.5	112.5	
500	250	255	266.5	112.5	
600	200	205	266.5	112.5	
600	250	255	466.5	147.5	
600	300	305	466.5	147.5	
800	250	255	466.5	147.5	
800	300	305	466.5	147.5	

## Usable depth

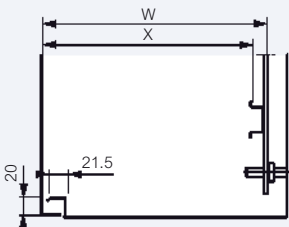

Enclosures depth (mm)	Back of enclosures	
	W (mm)	X (mm)
150	130	115
200	180	165
250	230	215
300	280	265

## Plinths

Trap doors

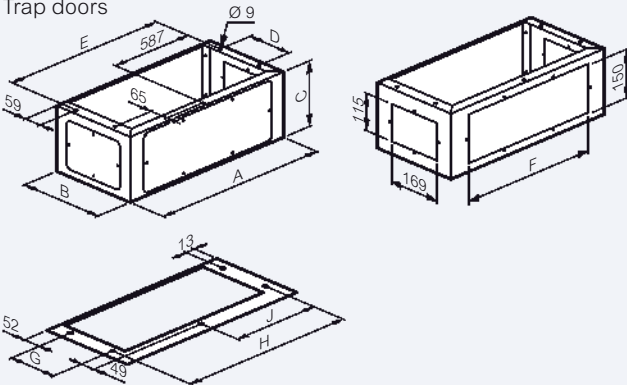

Cat.Nos	Cabinets W x D (mm)	A	B	C	D	E	F	G	H	J
0 363 00	600 x 300	600	280	200	150	574	469	150	542	271
0 363 01	800 x 300	800	280	200	150	774	469	150	742	371

## Fixing dimensions

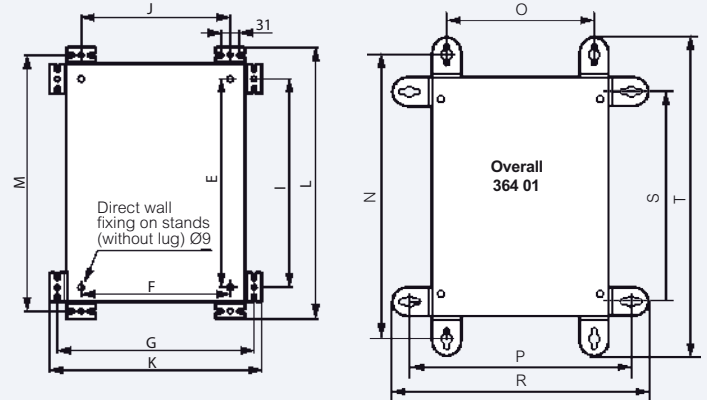

Cabinets	Vertical lugs	Mounting centres	Horizontal lugs	Mounting centres	Overall	Overall 0 364 01	Vertical lugs	Horizontal lugs							
H (mm)	W (mm)	M (mm)	J (mm)	E (mm)	I (mm)	G (mm)	F (mm)	L (mm)	K (mm)	T (mm)	R (mm)	N (mm)	O (mm)	P (mm)	S (mm)
300	200	330	150	250	250	230	150	366	356	430	330	375	150	275	250
300	300	330	250	250	250	330	250	366	356	430	430	375	250	375	250
300	400	330	350	250	250	430	350	366	456	430	530	375	350	475	250
400	300	430	250	350	350	330	250	456	356	530	430	475	250	375	350
400	400	430	350	350	350	430	350	456	456	530	530	475	350	475	350
400	600	430	550	350	350	530	550	456	656	530	730	475	550	575	350
500	400	530	350	450	450	430	350	556	456	630	530	575	350	475	450
500	500	530	450	450	450	530	450	556	556	630	630	575	450	575	450
600	400	630	350	550	550	430	350	656	456	730	530	675	350	475	550
600	500	630	450	550	550	530	450	656	556	730	630	675	450	575	550
600	600	630	550	550	550	630	550	656	656	730	730	675	550	675	550
700	500	730	450	650	650	530	450	756	556	830	630	775	450	575	650
800	600	830	550	750	750	630	650	856	656	930	730	875	550	675	750
800	800	830	750	750	750	830	750	856	856	930	930	875	750	875	750
1000	600	1030	550	950	950	630	550	1056	656	1130	730	1075	550	675	950
1000	800	1030	750	950	950	830	750	1056	856	1130	930	1075	750	875	950
1200	800	1230	750	1150	1150	830	750	1256	856	1330	930	1275	750	875	1150

## Roofs fixing

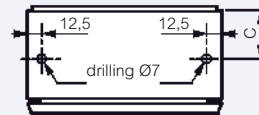

Cat.Nos	C (mm)
0 365 51/52	100
0 365 53/54/64	125
0 365 56/57	150



# Enclosures for all corrosive environments

Designed in fibreglass reinforced polyester, these enclosures are particularly suitable for corrosive environments: petrochemical, food processing industries and provide excellent UV resistance.



Marina enclosures p. 252



Marina cabinets p. 250

## DISCOVER THE RANGE

- Fiber glass reinforced polyester cabinets
- IP 66 - IK 10
- Class II (used to create totally isolated assemblies)
- 8 sizes of cabinets and 3 sizes of enclosures from 300 x 220 x 160 mm to 1800 x 800 x 400 mm
- Equipment fixed directly at the back of the cabinets thanks to a complete range of accessories



0 362 56



0 362 76



Cabinet and equipment selection chart p. 242-243  
Technical characteristics p. 254

IP 66 according to IEC EN 60529  
LCIE n°60059283-560528  
IK 10 according to IEC EN 62262 (EN 50102)  
Class II (used to create totally isolated assemblies acc. to EN 60439-1 and assemblies for photovoltaic installations acc. to UTE C15-712-1)  
Fiber glass reinforced polyester  
Self-extinguishing 960°C acc. to IEC EN 60695-2-11  
Adapted to corrosive environment and different weather conditions  
Reversible door, opening 180°, (except Cat.No 0 362 50)  
Stainless steel hinge pins (except Cat.No 0 362 50)  
2 double bar lock (1 lock for Cat.No 0 362 50)  
Direct fixing of equipment at bottom of cabinet (screws supplied)  
Possible to fit a partial plate from 500 x 400 x 200 mm and/or rails on intermediate studs (except for Cat.No 0 362 50)  
Optional depth adjustment from height 400 x width 300 mm with Cat.No 0 362 42

Pack	Cat.Nos	RAL 7035 cabinets	
		External dimensions (mm) Height x Width x Depth	Corresponding metal cabinets (mm) Height x Width x Depth
1	0 362 50	300 x 220 x 160	300 x 200 x 160
1	0 362 51	400 x 300 x 206	400 x 300 x 200
1	0 362 52	500 x 400 x 206	500 x 400 x 200
1	0 362 55	610 x 400 x 257	600 x 400 x 250
1	0 362 56	720 x 510 x 250	700 x 500 x 250
1	0 362 61	820 x 610 x 300	800 x 600 x 300
1	0 362 63	1020 x 810 x 300	1000 x 800 x 300
1	0 362 64	1220 x 810 x 300	1200 x 800 x 300

		RAL 7035 cabinets with glass door	
		External dimensions (mm) Height x Width x Depth	Window dimensions (mm) Height x Width
1	0 362 71	400 x 300 x 206	235 x 145
1	0 362 72	500 x 400 x 206	335 x 245
1	0 362 75	610 x 400 x 257	463 x 245
1	0 362 76	720 x 510 x 250	570 x 272
1	0 362 81	820 x 610 x 300	672 x 372
1	0 362 83	1020 x 810 x 300	770 x 495
1	0 362 84	1220 x 810 x 300	970 x 495



Plastic industrial boxes  
p. 562



Heat regulation for cabinets and enclosures  
p. 262

## Equipment for Marina cabinets



0 362 63  
with plinth Cat.No 0 362 92  
and roof Cat.No 0 362 95



0 362 56  
on stand Cat.No 0 364 36  
and cross-pieces  
Cat.No 0 364 39

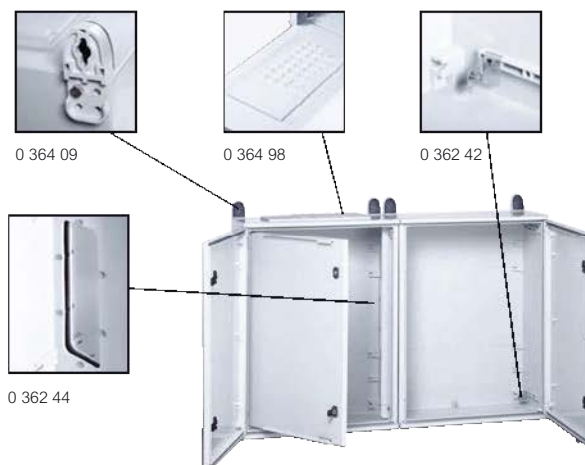

Example of cabinets Cat.No 0 362 61 associated and equipped:  
- Lugs Cat.No 0 364 09  
- Internal door Cat.No 0 363 63 (p. 259)  
- Cabstop plate + kit Cat.No 0 364 98 (p. 245)  
- Twin kit Cat.No 0 362 44  
- Depth adjustment kit Cat.No 0 362 42

Cabinet and equipment selection chart p. 242-243  
Technical characteristics p. 254

Pack	Cat.Nos	Plinths RAL 7035
		Height 170 mm Front and rear trap door Possibility to overlap 2 plinths
1	0 362 91	For cabinets Cat.Nos 0 362 61/81
1	0 362 92	For cabinets Cat.Nos 0 362 61/64/83/84
Roofs RAL 7035		
1	0 362 93	For cabinets Cat.Nos 0 362 56/76
1	0 362 94	For cabinets Cat.Nos 0 362 61/81
1	0 362 95	For cabinets Cat.Nos 0 362 61/64/83/84
Fixing accessories		
		IP 66 maintained
Wall mounting lugs		
		Set of 4, supplied with screws
1	0 364 08	For cabinets height 300 mm. For 100 kg load
1	0 364 09	For cabinets height 400 and 1200 mm. For 150 kg load
Rear with threaded rod		
10	0 362 40	M8 for cabinets height $\geq$ 400 mm Mounting at back of cabinets
On ground		
		Stand comprised of 2 feet for fixing cabinets high up Supplied with cabinet fixing screws Hot galvanized steel Conform to EN 50125-3 (railway applications, fixed installations)
1	0 364 36	For cabinets height 400 to 800 mm
1	0 364 37	For cabinets height 1000 to 1200 mm
1	0 364 39	Anti-tipping cross-pieces Option of fitting casters Cat.No 0 464 83 (p. 701)

Pack	Cat.Nos	Accessories
1	0 362 42	Depth adjustment kit for cabinets depth $\geq$ 200 mm, for plate or uprights (p. 258)
10	0 394 49	Set of 4 lugs, supplied with screws Set of 2 supports for 45° rail slope Supplied with 4 M6 screws, nuts and washers
1	0 364 98	Kit for mounting Cabstop plate on plain plate Enables mounting of 2 Cabstop plates: Cat.Nos 0 364 94 or 95, and 0 364 96 or 97 IP 55 maintained
1	0 362 44	Twin kit (horizontal or vertical) for cabinets $\geq$ 500 mm height Comprising: - 1 frame for cable crossing and weather proofing - 2 linking pieces for fixing lugs (Cat.No 0 364 09 to be ordered separately)
1	0 365 13	Padlock adaptor stainless steel for Marina cabinets height $\geq$ 400 mm additional to latches Takes 3 padlocks $\varnothing$ 6 max.

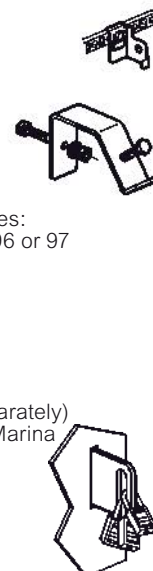

## Marina enclosures

polyester - IP 66 - IK 10



0 362 85



0 362 86 with plinth Cat.No 0 362 96  
internal door Cat.No 0 363 67  
and roof Cat.No 0 362 97

### Technical characteristics p. 254

IP 66 acc. to IEC EN 60529  
LCIE n° 60059283-560528  
IK 10 acc. to EN 62262 (EN 50102)  
Class II (Used to create totally isolated assemblies acc. to EN 60439-1)  
Fiberglass reinforced polyester  
Self-extinguishing 960°C acc. to IEC EN 60695-2-11  
Adapted to corrosive environment  
Supplied with fixing kit for plain plates or sectionned uprights  
Depth adjustment of equipment  
Equipped with low cable entries plate  
Reversible door with strand-holder  
3 point closing with handle fitted with 1/2 locking latch 2433 A (other key code, please consult us)  
Stainless steel hinges and hinges axis

Pack	Cat.Nos	Enclosures RAL 7035	External dimensions (mm) Height x Width x Depth	Corresponding metal enclosures (mm) Height x Width x Depth
1	0 362 85		1460 x 800 x 463	1400 x 800 x 400
1	0 362 86		1660 x 800 x 463	1600 x 800 x 400
1	0 362 87		1860 x 800 x 463	1800 x 800 x 400

Pack	Cat.Nos	Plinth RAL 7035
1	0 362 96	Height 170 mm Front and rear trap door Possibility to overlap 2 plinths For enclosure width 800 x depth 400 mm

Pack	Cat.Nos	Roof RAL 7035
1	0 362 97	For enclosure width 800 x depth 400 mm

## Equipment for Marina enclosures

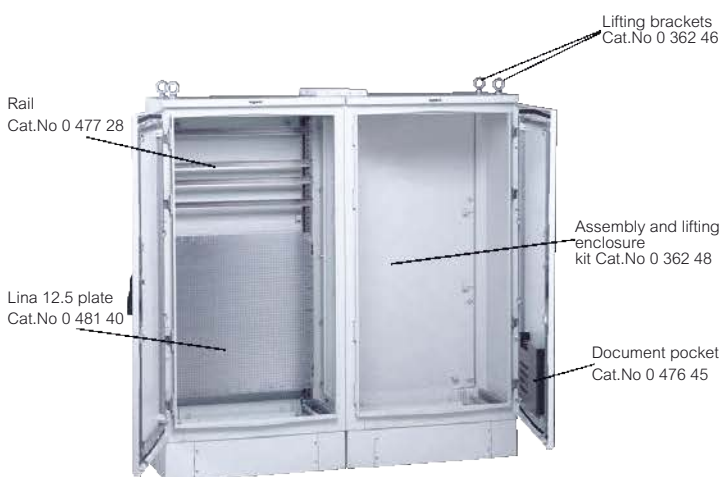

Example of 2 enclosures Cat.No 0 362 85 on plinth  
Cat.No 0 362 96, associated and equipped

Pack	Cat.Nos	Equipment
		<b>Plain plates</b> Galvanized steel. Pre-marked pitch 100 mm Admissible load: 200 kg/m <sup>2</sup>
		For enclosures
		Height x Width (mm)
1	0 349 59	1400 x 800
1	0 349 50	1600 x 800
1	0 344 18	1800 x 800
		Net weight (kg)
		27
		30.5
		34
		<b>Lina 12.5 plates</b> Galvanized steel With drilling for fixing equipment without marking Automatic bracket: - Ø6.5 mm for plastic rivet Cat.No 0 366 44 (trunking) - Ø3.3 mm for equipment with screw Cat.No 0 347 45 For installation of Cat. No 0 481 40/43, use Lina 25 sectionned uprights (p. 258) Cat. No 0 364 08 can be fixed directly on the back of the enclosure (1400 mm height enclosures) Admissible load: 150 kg/m <sup>2</sup>
		Plates
		Height x Width (mm)
1	0 481 40	800 x 800
1	0 481 43	1000 x 800
1	0 346 08	1400 x 800
		Net weight (kg)
		5.9
		7.6
		14.6
		<b>Lina 25 perforated plates</b> Zinc steel For mounting with sectionned uprights (except plain plate Cat.No 0 346 09) Admissible load: 50 kg/m <sup>2</sup>
		Plates
		Height x Width (mm)
1	0 474 90	800 x 800
1	0 474 95	1000 x 800
1	0 346 09	1400 x 800
		Net weight (kg)
		3.9
		5
		6.7
		<b>Internal doors RAL 7035</b> IP xxB steel. Textured polyester coated steel Double bar lock. Take key barrels and other knockouts (p. 260) Distance between enclosure door and internal door 78 mm Right or left opening, handle included
		For cabinets
		Height x Width (mm)
1	0 363 66	1400 x 800
1	0 363 67	1600 x 800
1	0 363 68	1800 x 800
		Door dim. (mm) Height x Width
		1280 x 675
		1480 x 675
		1680 x 675
		Door usable dim. (mm) Height x Width
		1200 x 580
		1400 x 580
		1600 x 580

## Equipment for Marina enclosures (continued)



0 374 02



0 362 46

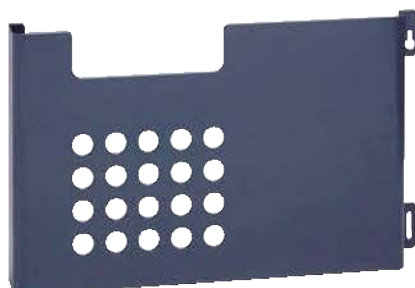

0 476 45

Pack	Cat.Nos	Screws	
500	0 366 44	Rivet reinforced plastic Ø6 mm for drilling Ø6.5 mm	
100	0 347 45	Screw head H 4.8 x 16 mm self-drilling, self-tapping for Ø3.3 mm	
200	0 347 50	Screw caps for isolation of screw head Cat.No 0 347 45 inside the trunking	
<b>Sectionned uprights</b>			
For Lina 25 rail, Lina rail and Lina 12.5 or Lina 25 plates			
Set of 2 uprights galvanized steel			
		For enclosures	
		Height (mm)	
		Length (mm)	
1	0 363 90	1400	1284
1	0 363 91	1600	1484
1	0 363 92	1800	1684
<b>Rails</b>			
<b>Lina 25 rail</b>			
Galvanized steel			
For enclosures width 800 mm			
5	0 477 28	Lina 15 mm depth	
<b>Rail to be cut</b>			
10	0 374 02	EN 60715	
<b>Lifting accessories</b>			
1	0 362 46	Lifting brackets M14	
Set of 4 brackets for max. load 500 kg/m <sup>3</sup>			
Supplied with blanking plates			
1	0 362 48	Assembly and lifting enclosures kit:	
- 2 support brackets			
- screws			
- weatherproof seal			
For 500 kg/m <sup>3</sup> lifting, order separately			
one set of 4 brackets Cat.No 0 362 46			
<b>Metal document holder (for plans)</b>			
1	0 476 45	RAL 7012. Fixed on door width 800 mm	
Internal dimensions: W. 425 x H. 275 x D. 50 mm			

ADDITIONAL SOLUTIONS  
AVAILABLE ON REQUEST

# Solutions for specific applications

Atlantic stainless steel cabinets, Axis control consoles or Altis enclosures, three ranges available on request or made to measure for specific environments or for local control of industrial processes



Altis automation enclosure



Atlantic stainless steel cabinets



Atlantic Axis control consoles

## CUSTOM MADE RANGES



If you want to know more about Legrand custom made ranges ( pre-drilled enclosures, special colours etc.. ) please contact your Area Commercial Manager

# Marina cabinets and enclosures

polyester - IP 66 - IK 10

## Dimensions, weights and usable areas of cabinets

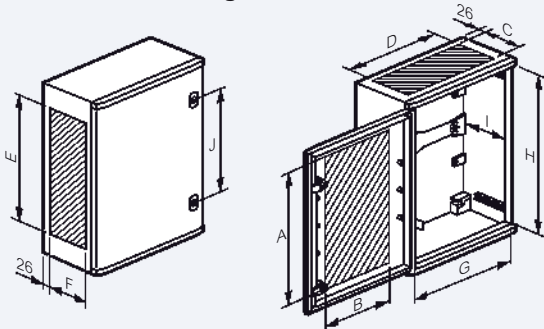

Door usable area for Cat. No 0 362 50

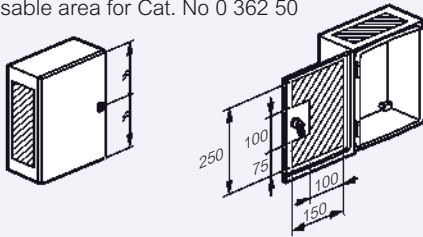

Cat. Nos	Usable area (mm)										Weight (kg)	Weight with window door (kg)
	A <sup>(1)</sup>	B <sup>(1)</sup>	C	D	E	F	G	H	I maxi	J		
0 362 50	250	150	105	195	250	115	194	280	-	-	1.75	-
0 362 51/71	300	180	130	250	260	150	260	350	178	200	3.7	4
0 362 52/72	400	280	130	350	360	150	360	450	178	300	5.1	5,6
0 362 55/75	500	280	180	350	460	180	360	560	225	400	6.4	7
0 362 56/76	600	340	170	400	560	170	460	662	211	400	11.2	12,3
0 362 61/81	700	440	220	500	660	230	560	762	261	500	15.2	16,7
0 362 63/83	900	600	220	700	860	230	760	962	261	580	21.8	23,9
0 362 64/84	1100	600	220	700	1060	230	760	1162	261	700	25	27,5

1: Except window version

## Equipment fixing in cabinets

Cat. Nos	Usable area (mm)					
	A	B	C	D	E <sup>(1)</sup>	F
0 362 50	263	163	-	-	-	-
0 362 51/71	325	225	125	225	102,5	228,5
0 362 52/72	425	325	225	325	87,5	228,5
0 362 55/75	525	325	325	325	95	328,5
0 362 56/76	625	425	425	425	100	428,5
0 362 61/81	725	525	525	525	100	528,5
0 362 63/83	925	725	725	725	100	728,5
0 362 64/84	1125	725	925	725	100	728,5

1: 2 studs on height Cat.No 0 362 50

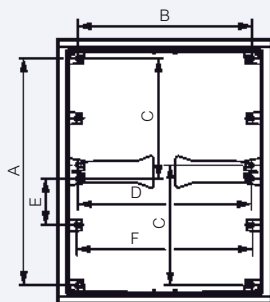

Partial plates mounting

Cabinet Cat. Nos	Plate dim. (mm)	Plate Cat. Nos		
		Plain	Lina 12.5	Lina 25
0 362 52/72	300 x 400	0 360 51	0 360 04	0 360 11
0 362 55/75	400 x 400	0 360 70	0 360 05	0 360 92
0 362 56/76	500 x 500	0 360 71	0 360 14	0 360 93
0 362 61/81	600 x 600	0 360 57	0 360 24	0 360 17
0 362 63/83	800 x 800	0 360 60	0 360 34	0 360 20
0 362 64/84	1000 x 800	0 360 61	0 360 21	0 360 42



## Adjustment of equipment (optional)

Cat. Nos	Plain plate (mm)		Chassis with rail (mm)	
	A max.	A min. (with Cat.No 0 362 42)	B max.	B min. (with Cat.No 0 362 42)
0 362 50	135	-	-	-
0 362 51/71	170	70	155	55
0 362 52/72	170	70	155	55
0 362 55/75	220	70	205	55
0 362 56/76	220	70	205	55
0 362 61/81	270	70	255	55
0 362 63/83	270	70	255	55
0 362 64/84	270	70	255	55

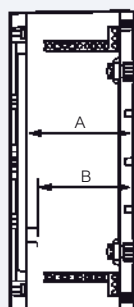

## Plinths and roofs

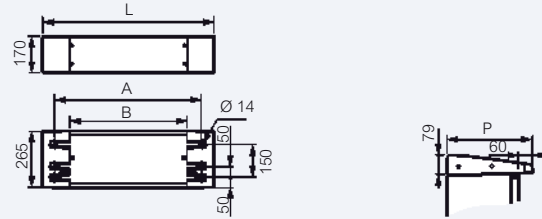

Plinths Cat. Nos	L (mm)	A (mm)	B (mm)	Weight (kg)
0 362 91	590	480	344	4.8
0 362 92	790	680	544	5.4

Roofs Cat. Nos	Width (mm)	D (mm)	Weight (kg)
0 362 93	510	310	1
0 362 94	612	360	1.3
0 362 95	812	360	1.7

same fixing distances on ground and cabinet side

## Fixing

Cat.No 0 364 09

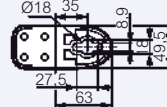

Cat.No 0 364 08

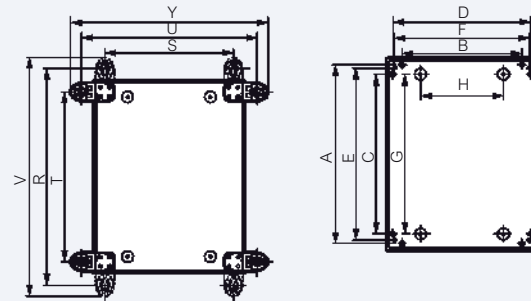
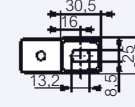

Cat. Nos	On stands 0 364 36 (mm)		Direct fixing outside mounting plate and stand area 0 364 37 (mm)		Direct fixing through rear of cabinet (mm)		With vertical brackets (mm)			With horizontal brackets (mm)		
	A	B	E	F	G	H	R	S	V	T	U	Y
0 362 50 <sup>(1)(2)</sup>	-	-	-	-	220	150	330	190	359	270	250	279
0 362 51/71	364	218	358	259	325	120	470	241	525	341	370	425
0 362 52/72	464	318	458	359	425	220	570	341	625	441	470	525
0 362 55/75	574	318	558	358	525	220	680	341	735	551	470	525
0 362 56/76	683	427	664	468	600	200	789	441	844	641	579	634
0 362 61/81	781	525	764	568	700	300	887	548	942	758	677	732
0 362 63/83	981	725	964	768	900	500	1087	748	1142	958	877	932
0 362 64/84	1181	725	1164	768	1100	500	1287	748	1342	1158	877	932

1: With brackets Cat.No 0 364 08

2: S and T dimensions: insert fixing centres

## Stands

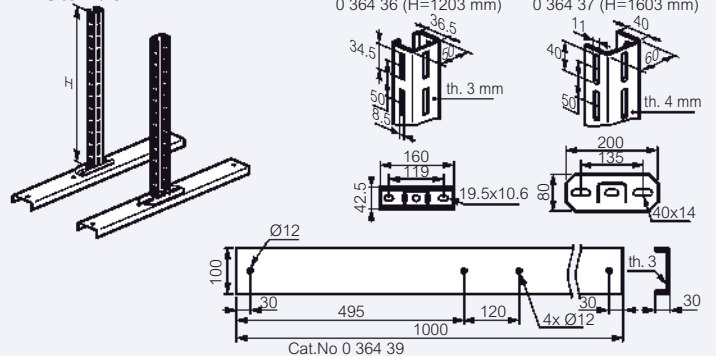

## Coupling kit for cabinets Cat.No 0 362 44

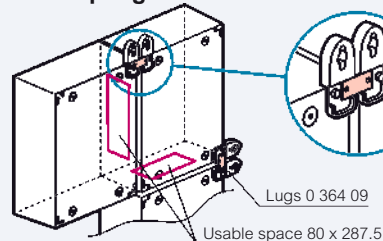



### Dimensions, weights and usable areas of enclosures

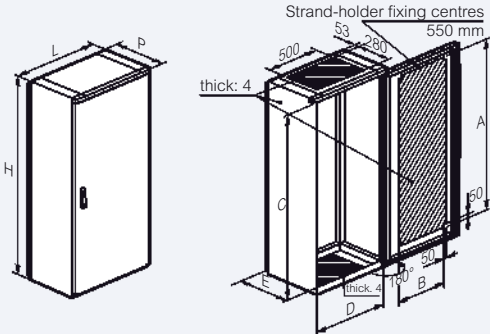

Cat.Nos	Dimensions H x W x D (mm)	Weight (kg)	Usable areas (mm)				E <sup>(2)</sup>
			A	B	C	D	
0 362 85	1460 x 800 x 463 <sup>(1)</sup>	49	1230	530	1300	700	380
0 362 86	1660 x 800 x 463 <sup>(1)</sup>	53	1430	530	1500	700	380
0 362 87	1860 x 800 x 463 <sup>(1)</sup>	57	1630	530	1700	700	380

1: 487 with handle  
2: Usable depth

### Adjustment of equipment in enclosures

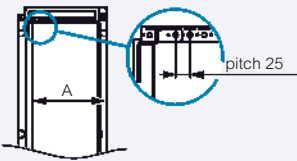

Plain plate (mm)		Partial plate (mm)		Chassis with rail (mm)	
A max	A min	A max	A min	A max	A min
379	109	357	88	351	82

### Plinth Cat.No 0 362 96

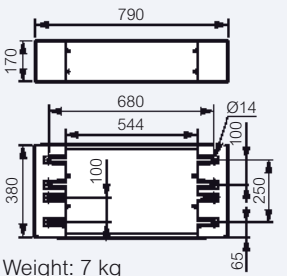

Weight: 7 kg

### Roof Cat.No 0 362 97

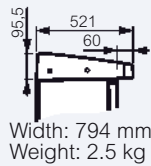

Width: 794 mm  
Weight: 2.5 kg

### Plates

#### Choice of plates

Plates	Enclosures H. 1400 mm	Enclosures H. 1600 mm	Enclosures H. 1800 mm
Plain	0 349 59	0 349 50	0 344 18
Lina 12,5	0 346 08	2 x 0 481 40 + uprights 0 363 91	0 481 43 + 0 481 40 + uprights 0 363 92
Lina 25 perforated	0 346 09	2 x 0 474 90 + uprights 0 363 91	0 474 90 + 0 474 95 + uprights 0 363 92

Plain plate

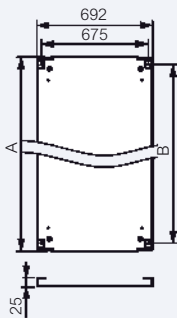

Lina 12.5 plate  
Cat.No 0 346 08

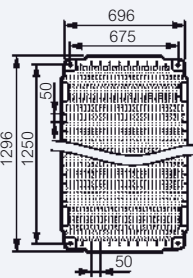

Lina 25  
perforated plate  
Cat.No 0 346 09

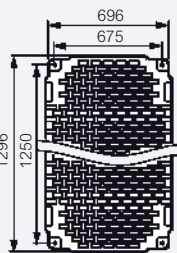

Enclosure height (mm)	Plain	
	A	B
1400	1292	1225
1600	1492	1425
1800	1692	1625

### Lina 12.5 partial plain and Lina 25 perforated plates

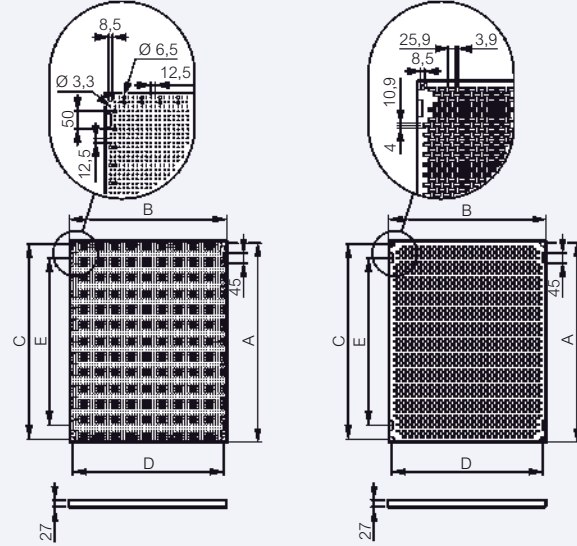

Enclosures dim Height x Width	Lina 12.5 partial plate and Lina 25 perforated plate					
	A	B	C	D	E	Area (dm <sup>2</sup> )
800 x 800	703	703	675	675	550	49
1000 x 1000	903	903	875	875	750	82

### Sectioned uprights Cat.Nos 0 363 90/91/92

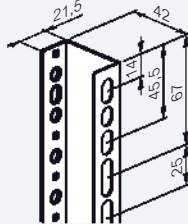

### Suggested lifting method 4 x 500 kg slings and 4 brackets

A } 120° → 250 kg  
90° → 300 kg  
60° → 300 kg

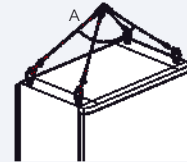

### Assembly and lifting kit Cat.No 0 362 48 and lifting kit Cat.No 0 362 46

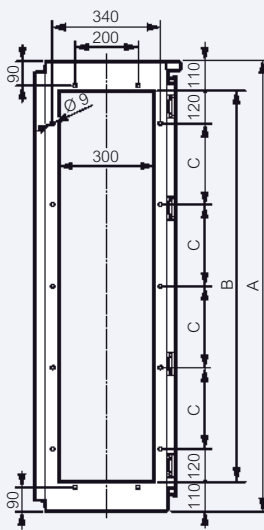

A } 120° → 500 kg  
90° → 600 kg  
60° → 600 kg

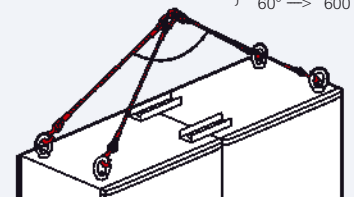

A } 90° → 800 kg  
60° → 900 kg

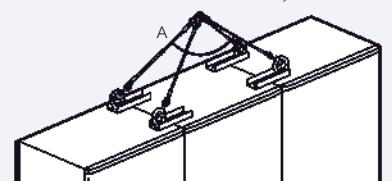

Enclosures Cat.Nos	Enclosures dimensions (mm)	Dimensions (mm)		
		A	B	C
0 362 85	1400 x 800 x 400	1460	1240	250
0 362 86	1600 x 800 x 400	1660	1440	300
0 362 87	1800 x 800 x 400	1860	1640	350

# Atlantic, Atlantic-E and Marina cabinets: plain plates and perforated plates



0 360 58



0 360 31

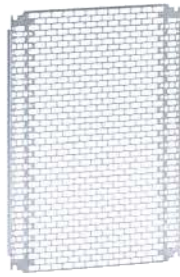

0 360 18



0 355 08 with Lina 12.5 plate  
Cat.No 0 360 22  
vertical mounting



0 355 06 with Lina 12.5 plate  
Cat.No 0 360 22  
horizontal mounting

Cabinet and equipment selection chart p. 242-243  
Technical characteristics p. 257

Pack	Cat.Nos	Plain plates				
		Galvanized steel Not compatible with Atlantic-E cabinets				
		Vertical mounting for cabinets			Horizontal mounting for cabinets	
		Height (mm)	Width (mm)	Weight (kg)	Height (mm)	Width (mm)
1	0 360 49 <sup>1</sup>	300	220	0.9		
1	0 360 69	300	300	1		
1	0 360 52	400	300	1.3	300	400
1	0 360 70	400	400	1.7		
1	0 360 55	500	400	2.7		
1	0 360 71	500	500	3.5		
1	0 360 56	600	400	3.3	400	600
1	0 360 57	600	600	6.2		
1	0 360 54	600	1000	10.6	1000	600
1	0 360 58	700	500	6		
1	0 360 59	800	600	8.4	600	800
1	0 360 60	800	800	11.4		
1	0 360 61	800	1000	14.4	1000	800
1	0 360 63	1000	1000	20.5		
1	0 360 64	1200	800	18.5		
1	0 360 65	1200	1000	23	1000	1200
1	0 360 66	1200	1200	34.4		
1	0 360 67 <sup>2</sup>	1400	800	26.4		
1	0 360 68	1400	1000	32.2		

Pack	Cat.Nos	Lina 12.5 plates				
		Galvanized steel. With drilling for fixing equipment without marking. Automatic bracket: - Ø6.5 mm for plastic rivet Cat.No 0 366 44 (trunking) - Ø3.3 mm for equipment with screw Cat.No 0 347 45				
		Vertical mounting for cabinets			Horizontal mounting for cabinets	
		Height (mm)	Width (mm)	Weight (kg)	Height (mm)	Width (mm)
1	0 360 00 <sup>2</sup>	300	200	0.4		
1	0 360 01 <sup>1</sup>	300	220	0.47		
1	0 360 02	300	300	0.6		
1	0 360 04	400	300	0.8	300	400
1	0 360 05	400	400	1.1		
1	0 360 09	500	400	1.5		
1	0 360 14	500	500	1.85		
1	0 360 22	600	400	2.2	400	600
1	0 360 24	600	600	3.7		
1	0 360 40	600	1000	6.8	1000	600
1	0 360 31	700	500	3.7		
1	0 360 33	800	600	5.2	600	800
1	0 360 34	800	800	7		
1	0 360 42	1000	800	9.2	800	1000
1	0 360 43	1000	1000	11.5		
1	0 360 46	1200	800	11.1		
1	0 360 47	1200	1000	13.9	1000	1200
1	0 360 48	1200	1200	16.7		
1	0 360 75 <sup>2</sup>	1400	800	13		
1	0 360 79	1400	1000	16.2		

Pack	Cat.Nos	Lina 25 perforated plates	
		Galvanized steel	
		Common for all types of cabinets	
		For cabinets Height x Width (mm)	Weight (kg)
1	0 360 07 <sup>2</sup>	300 x 200	0.4
1	0 360 99 <sup>1</sup>	300 x 220	0.4
1	0 360 91	300 x 300	0.5
1	0 360 11	300 x 400	0.6
1	0 360 12	400 x 300	0.6
1	0 360 92	400 x 400	0.8
1	0 360 13	400 x 600	1.1
1	0 360 15	500 x 400	0.9
1	0 360 93	500 x 500	1.1
1	0 360 16	600 x 400	1.3
1	0 360 17	600 x 600	2.1
1	0 360 06	600 x 800	3.1
1	0 360 08	600 x 1000	3.7
1	0 360 18	700 x 500	2
1	0 360 19	800 x 600	3.1
1	0 360 20	800 x 800	4
1	0 360 94	800 x 1000	5
1	0 360 23	1000 x 600	3.7
1	0 360 21	1000 x 800	4.9
1	0 360 25	1000 x 1000	6.8
1	0 360 10	1000 x 1200	8.5
1	0 360 87	1200 x 800	7.1
1	0 360 88	1200 x 1000	8.5
1	0 360 89	1200 x 1200	10.1
1	0 360 90 <sup>2</sup>	1400 x 800	7.8
1	0 360 98	1400 x 1000	10

**Clip-nuts for perforated plates**  
Supplied without screw  
100 0 364 40 For M4 screws  
100 0 364 41 For M5 screws  
100 0 364 42 For M6 screws

**Accessories**  
500 0 366 44 Rivet reinforced plastic Ø6 mm for drilling Ø6.5 mm  
100 0 347 45 Screw head 4.8 x 16 mm self-drilling, self-tapping for Ø3.3 mm  
200 0 347 50 Screw cover for isolation of screw head Cat.No 0 347 45 inside the trunking

1: For Marina cabinets  
2: For Atlantic and Atlantic-E cabinets

# Atlantic, Atlantic-E and Marina cabinets: plain plates and perforated plates

## Mounting principle

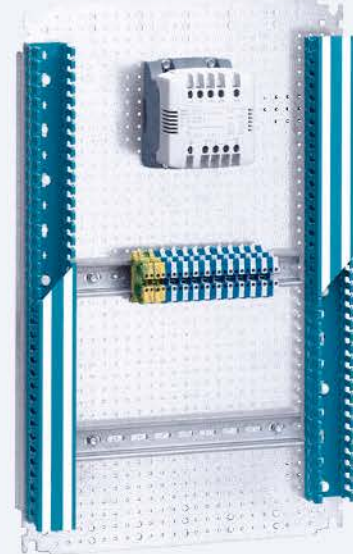
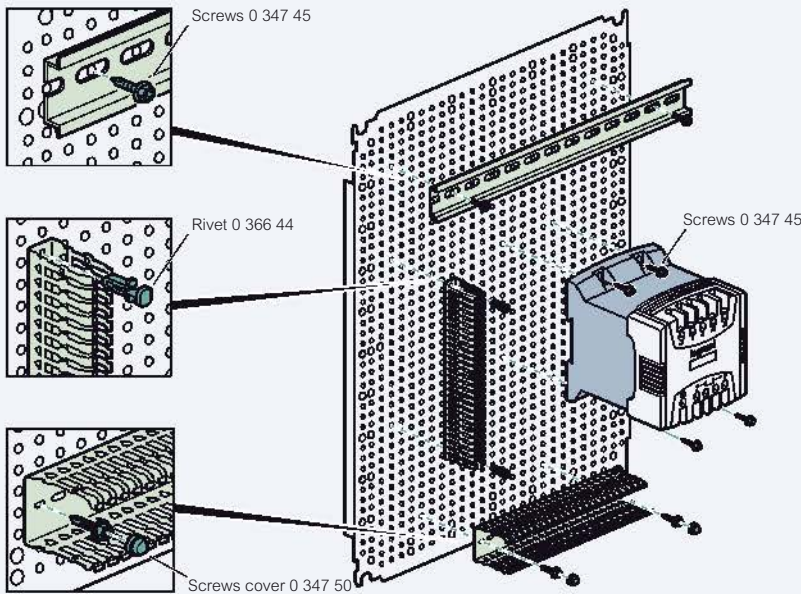

Fixing exemple on Lina 12.5 plate:  
 - of a transformer with screws Cat.No 0 347 45  
 - of a rail  
 - of Lina 25 cable ducting (p. 300)

## Dimensions

### Assembled chassis with rails and Lina 25 uprights

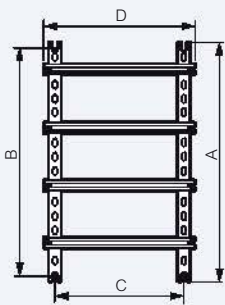

### Lina 12.5 plain plates and Lina 25 perforated plates

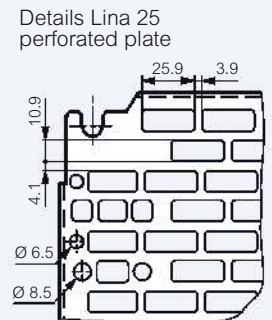
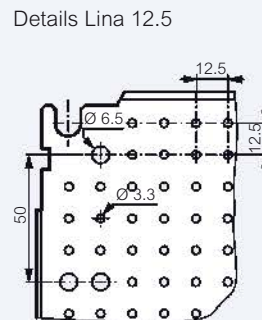
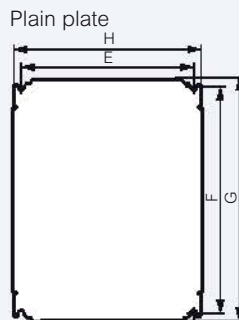

Dimensions of cabinets Height x Width (mm)	Uprights		Rail length		Chassis fixing	
	A (mm)	D (mm)	B (mm)	C (mm)		
300 x 300	237	243	225	225		
300 x 400	237	343	225	325		
400 x 300	337	243	325	225		
400 x 400	337	343	325	325		
400 x 600	337	543	325	525		
500 x 400	437	343	425	325		
500 x 500	437	443	425	425		
600 x 400	537	343	525	325		
600 x 600	537	543	525	525		
600 x 800	537	743	525	725		
600 x 1000	537	943	525	925		
700 x 500	637	443	625	425		
800 x 600	737	543	725	525		
800 x 800	737	743	725	725		
800 x 1000	737	943	725	925		
1000 x 600	937	543	925	525		
1000 x 800	937	743	925	725		
1000 x 1000	937	943	925	925		
1000 x 1200	937	1143	925	1125		
1200 x 800	1137	743	1125	725		
1200 x 1000	1137	943	1125	925		
1200 x 1200	1137	1143	1125	1125		
1400 x 800	1337	743	1325	725		
1400 x 1000	1337	943	1325	925		

Cabinets dimensions Height x Width (mm)	Dimensions of plates Plain / Lina 12.5 / 25 plates		Usable space for equipment (dm <sup>2</sup> )	Mounting of plates	
	G (mm)	H (mm)		F (mm)	E (mm)
300 x 200	256	156	4.2	225	125
300 x 220	275	192	5.3	263	163
300 x 300	256	256	6.2	225	225
300 x 400 <sup>(1)</sup>	256	356	8.2	225	325
400 x 300 <sup>(1)</sup>	356	256	8.2	325	225
400 x 400	356	356	11.7	325	325
400 x 600 <sup>(1)</sup>	356	556	18.7	325	525
500 x 400	456	356	15.2	425	325
500 x 500	456	456	19.2	425	425
600 x 400 <sup>(1)</sup>	556	356	18.7	525	325
600 x 600	556	556	29.7	525	525
600 x 800 <sup>(1)</sup>	556	756	40.7	525	725
600 x 1000 <sup>(1)</sup>	556	956	51.7	525	925
700 x 500	656	456	28.7	625	425
800 x 600 <sup>(1)</sup>	756	556	40.7	725	525
800 x 800	756	756	55.7	725	725
800 x 1000 <sup>(1)</sup>	756	956	71.7	725	925
1000 x 600 <sup>(1)</sup>	956	556	51.7	925	525
1000 x 800 <sup>(1)</sup>	956	756	70.7	925	725
1000 x 1000	956	956	89.7	925	925
1000 x 1200 <sup>(1)</sup>	956	1156	108.7	925	1125
1200 x 800	1156	756	85.7	1125	725
1200 x 1000 <sup>(1)</sup>	1156	956	108.7	1125	925
1200 x 1200	1156	1156	131.7	1125	1125
1400 x 800	1356	756	100.7	1325	725
1400 x 1000	1356	956	127.7	1325	925

1: For horizontal or vertical mounting



Cabinet and equipment selection chart **p. 242-243**  
 Technical characteristics **p. 260**

## Pack Cat.Nos Lina 25 sectioned uprights

Pack	Cat.Nos	Set of 2 uprights		Section
		For cabinets height (mm)	Length (mm)	
5	0 361 50	300	237	L
5	0 361 51	400	337	
5	0 361 52	500	437	
5	0 361 53	600	537	
5	0 361 54	700	637	
5	0 361 55	800	737	
5	0 361 56	1000	937	
1	0 361 58	1200	1137	
1	0 361 59	1400	1337	
10	0 361 92	<b>Upright to be cut</b> Length 3 m - Section L		

Pack	Cat.Nos	Lina 25 rail		Section
		For cabinets width (mm)	Crosspiece length (mm)	
10	0 367 80	300	243	┌
10	0 367 81	400	343	
10	0 367 82	500	443	
10	0 367 83	600	543	
10	0 367 84	800	743	
10	0 367 85	1000	943	
10	0 367 86	1200	1143	
10	0 374 02	<b>Rail to be cut, length 2 m</b> ┌ EN 60715		
10	0 374 07	Symmetrical ┌ depth 15 mm		
10	0 374 04	Symmetrical ┌ EN 60175 depth 7.5 mm		
10	0 477 22	┌ depth 7.5 mm with oblongs		
10	0 477 23	┌ depth 15 mm with oblongs		

Pack	Cat.Nos	Protective conductor lug
5	0 367 36	Support lug for protection copper bar For Atlantic enclosures only

Pack	Cat.Nos	Wall-mounting VDI chassis for Atlantic, and Marina cabinets
1	0 462 27	6 U chassis
1	0 462 28	12 U chassis
1	0 462 29	16 U chassis

For integrating 19" VDI equipment in Atlantic, and Marina cabinets, width 600 or 800 mm and depth 250 mm min.  
 In 400 mm wide cabinets, the chassis can integrate 10" VDI equipment (p. 705)  
 Can be fixed directly to the wall to create a wall-mounting chassis (without cabinet)  
 Self-locking cable ties and cable ties with tightening indicator (p. 713) can be fitted  
 Technical characteristics see p. 729

## Pack Cat.Nos Copper bars

Pack	Cat.Nos	Copper bars with tapped holes				
		Cross-section (mm)	Permis I (A)	Tapped holes		Length (mm)
10	0 373 88	12 x 2	110	Ø mm	Pitch	990
10	0 373 89	12 x 4	160	M5	18	990
100	0 373 65 <sup>1</sup>	<b>Connectors for bars with tapped holes</b> 1 or 2 conductor from 1.5 to 10 mm <sup>2</sup> (supplied with Ø5 mm screws)				
10	0 373 49	<b>Non perforated copper bar</b>				
100	0 373 60	12 x 4	180	Length (mm)	991.5	
10	0 373 61	1.5 to 4 mm <sup>2</sup>				
10	0 373 62	6 to 16 mm <sup>2</sup>				
10	0 373 62	10 to 35 mm <sup>2</sup> (supplied with M6 CHC Ø5 mm)				

Pack	Cat.Nos	Door contact
1	0 363 13	For example, to cut off the air conditioning and the lighting supply as soon as the enclosure or cabinet door is opened 3 A - 240 V 1 NC contact + 1 NO contact For Atlantic, Atlantic-E and Marina cabinets Supplied with fixing lug

Pack	Cat.Nos	Hinged glass doors					
		Width (mm)	Height (mm)	External dim. Width (mm)	Window Height (mm)	Window Depth (mm)	Usable Depth (mm)
1	0 475 45	300	400	50	230	330	42
1	0 475 46	400	400	50	330	330	42
1	0 475 47	500	500	50	430	430	42

IP 54  
 Anodised aluminium frame  
 Polycarbonate transparent window, 3 mm stick  
 Neoprene seal  
 455 key lock. 120° opening  
 Supplied complete with drilling template  
 For devices on front panels. Protect the devices and prevent accidental operation

## Self adhesive document holder (for plans)

Pack	Cat.Nos	Open - RAL 7035			
		External dimensions		Internal dimensions	
		Width (mm)	Height (mm)	Width (mm)	Height (mm)
20	0 365 80	340	235	310	200
20	0 365 81	260	165	230	130
1	0 365 82	<b>Closed - RAL 7035</b> Rigid plastic - IP 50 Internal dimensions: 324 x 120 x 18 mm			
10	0 097 99	<b>Transparent</b> Flexible plastic - A4 - 320 x 220 mm			

<sup>1</sup>: Protective conductor per connector (art. 12 of French decree of 14/11/89)

# Atlantic, Atlantic-E and Marina cabinets chassis and internal doors



0 361 03 mounted in cabinet  
Cat.No 0 354 94



0 363 60 mounted in Atlantic metal  
cabinets Cat.No 0 355 03 (p. 244)  
with Cat.No 0 363 69



Accept key barrel

Cabinet and equipment selection chart **p. 242-243**  
Technical characteristics **p. 260**

Pack	Cat.Nos	Chassis with insulating faceplates RAL 7035
1	0 361 01	<p>Symmetrical rails 15 mm depth Supplied complete with uprights and faceplates Space between door and faceplate for Atlantic, Atlantic-E and Marina cabinets :</p> <ul style="list-style-type: none"> <li>- 70 mm for cabinets depth 200 mm</li> <li>- 80 mm for cabinets depth 250 mm</li> <li>- 90 mm for cabinets depth 300 mm</li> </ul> <p>Self extinguishing 750 °C acc. to IEC EN 60695-2-11</p> <p><b>For cabinets 400 x 300 x 200</b> 30 modules (3 rows of 10) Supplied with 1 blanking plate</p>
1	0 361 02	<p><b>For cabinets 500 x 400 x 200</b> 48 modules (3 rows of 16) Supplied with 1 blanking plate</p>
1	0 361 03	<p><b>For cabinets 600 x 400 x 250</b> 48 modules (3 rows of 16) Supplied with 1 blanking plate</p>
1	0 361 05	<p><b>For cabinets 700 x 500 x 250</b> 84 modules (4 rows of 21) Supplied with 1 blanking plate</p>
1	0 361 06	<p><b>For cabinets 800 x 600 x 300</b> 108 modules (4 rows of 27) Supplied with 2 blanking plates Can take in 1st row a mounting plate Cat.No 0 360 44</p>
1	0 361 09	<p><b>For cabinets 1000 x 800 x 300</b> 190 modules (5 rows of 38) Supplied with 2 blanking plates Can take in 1st row a mounting plate Cat.No 0 360 45</p>
1	0 361 10	<p><b>For cabinets 1200 x 800 x 300</b> 228 modules (6 rows of 38) Supplied with 2 blanking plates Can take in 1st row a mounting plate Cat.No 0 360 45</p>
10	0 361 00	<p><b>Blanking plate</b> 38 modules, length 684 mm</p>

Pack	Cat.Nos	Mounting plates																								
1	0 360 44	For 800 x 600 mm cabinets for DPX <sup>3</sup> 160 or Vistop 160 A or DPX-IS 250, 63 to 250 A, please consult us																								
1	0 360 45	For 1000 x 800 mm or 1200 x 800 mm cabinets For 1, 2 or 3 DPX <sup>3</sup> 160, DPX <sup>3</sup> 250 or Vistop 160 A or DPX-IS 250, 63 to 250 A																								
		<p><b>Internal doors RAL 7035</b></p> <p>For direct routing in Marina cabinets, with Cat.No 0 363 69 in Atlantic metal cabinets IP XXB Polyester fiber glass reinforced, height 4 mm Self-extinguishing 960°C acc. to IEC EN 60695-2-11 Grid lines integrated on back Centre marking on front Adjustable distance between cabinet door and internal door: 42 to 50 mm for Atlantic cabinets, more than 100 mm for Marina cabinets Right or left opening, captive hinge pins Double bar key: 1 key for 400 to 600 mm height, 2 keys for height from 700 mm Take key barrels and other barrels</p> <table border="1"> <thead> <tr> <th>For cabinets Height x Width(mm)</th> <th>Dim. (mm) Height x Width</th> <th>Usable dim. (mm) Height x Width</th> </tr> </thead> <tbody> <tr> <td>1 0 363 59 400 x 300</td> <td>341 x 236</td> <td>305 x 185</td> </tr> <tr> <td>1 0 363 60 500 x 400</td> <td>441 x 336</td> <td>405 x 250</td> </tr> <tr> <td>1 0 363 61 600 x 400</td> <td>541 x 336</td> <td>505 x 250</td> </tr> <tr> <td>1 0 363 62 700 x 500</td> <td>642 x 436</td> <td>500 x 340</td> </tr> <tr> <td>1 0 363 63 800 x 600</td> <td>742 x 536</td> <td>600 x 440</td> </tr> <tr> <td>1 0 363 64 1000 x 800</td> <td>942 x 736</td> <td>800 x 640</td> </tr> <tr> <td>1 0 363 65 1200 x 800</td> <td>942 x 736</td> <td>800 x 640</td> </tr> </tbody> </table>	For cabinets Height x Width(mm)	Dim. (mm) Height x Width	Usable dim. (mm) Height x Width	1 0 363 59 400 x 300	341 x 236	305 x 185	1 0 363 60 500 x 400	441 x 336	405 x 250	1 0 363 61 600 x 400	541 x 336	505 x 250	1 0 363 62 700 x 500	642 x 436	500 x 340	1 0 363 63 800 x 600	742 x 536	600 x 440	1 0 363 64 1000 x 800	942 x 736	800 x 640	1 0 363 65 1200 x 800	942 x 736	800 x 640
For cabinets Height x Width(mm)	Dim. (mm) Height x Width	Usable dim. (mm) Height x Width																								
1 0 363 59 400 x 300	341 x 236	305 x 185																								
1 0 363 60 500 x 400	441 x 336	405 x 250																								
1 0 363 61 600 x 400	541 x 336	505 x 250																								
1 0 363 62 700 x 500	642 x 436	500 x 340																								
1 0 363 63 800 x 600	742 x 536	600 x 440																								
1 0 363 64 1000 x 800	942 x 736	800 x 640																								
1 0 363 65 1200 x 800	942 x 736	800 x 640																								
1	0 363 69	Accessory for mounting internal doors in Atlantic metal cabinets																								

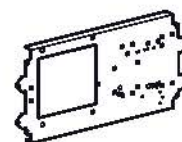

## Assembled chassis with rails and Lina 25 uprights

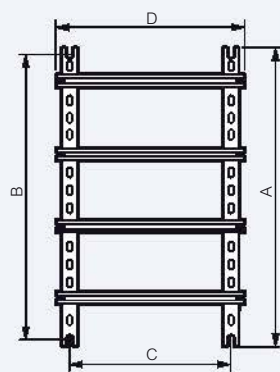

Dimensions of cabinets Height x Width (mm)	Uprights height		Rail length		Chassis fixing	
	A (mm)	D (mm)	B (mm)	C (mm)		
300 x 300	237	243	225	225		
300 x 400	237	343	225	325		
400 x 300	337	243	325	225		
400 x 400	337	343	325	325		
400 x 600	337	543	325	525		
500 x 400	437	343	425	325		
500 x 500	437	443	425	425		
600 x 400	537	343	525	325		
600 x 600	537	543	525	525		
600 x 800	537	743	525	725		
600 x 1000	537	943	525	925		
700 x 500	637	443	625	425		
800 x 600	737	543	725	525		
800 x 800	737	743	725	725		
800 x 1000	737	943	725	925		
1000 x 600	937	543	925	525		
1000 x 800	937	743	925	725		
1000 x 1000	937	943	925	925		
1000 x 1200	937	1143	925	1125		
1200 x 800	1137	743	1125	725		
1200 x 1000	1137	943	1125	925		
1200 x 1200	1137	1143	1125	1125		
1400 x 800	1337	743	1325	725		
1400 x 1000	1337	943	1325	925		

## Lina 25 sectioned uprights and uprights to be cut

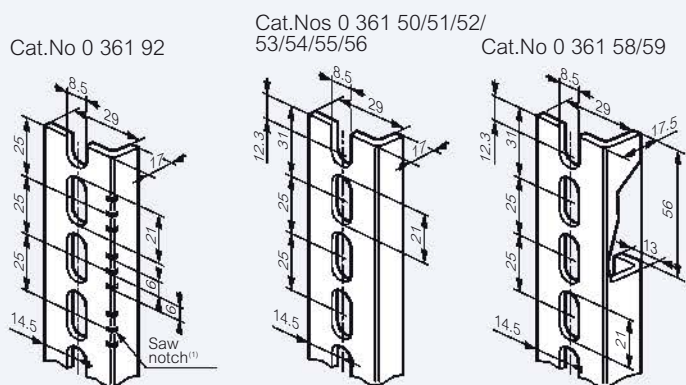

1: Saw notch for upright length x pitch 25, the 2 others for uprights Cat.Nos 0 361 50/51/52/53/54/55/56

## Rails

Cat.No 0 374 02      Cat.Nos 0 367 80/81/82/83/84/85/86 and 0 374 07

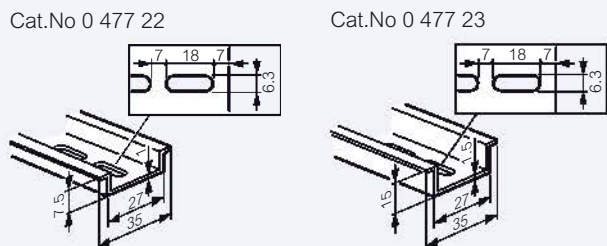
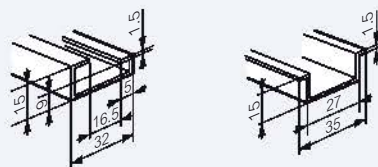

## Lock housings for rebate locks or key barrels

Pack	Cat.Nos	Description	Image
10	0 368 04	For Atlantic and Marina cabinets Lock	
10	0 368 05	Knob (with blanking plate)	
10	0 368 06	Knob fitted with key barrel 2433 A	

<b>Padlocking</b>			
1	0 365 11	Takes 3 safety padlocks Cat.No 0 227 97 (p. 60) Shackle Ø6 mm max. For fitting on Atlantic and Marina knob or lock RAL 7021 painted steel	
1	0 365 13	Padlock adaptor stainless steel for Marina cabinets height ≥ 400 mm additional to latches Takes 3 padlocks Ø6 max.	

<b>Locking latches</b>			
10	0 365 30	For Marina cabinets	
10	0 368 43	For Atlantic 1-door cabinet	

<b>Metal rebate locks</b>			
10	0 368 17 <sup>1</sup>	For Atlantic and Marina cabinets Triangle male 6.5 mm	
10	0 368 18 <sup>1</sup>	Triangle male 8 mm	
10	0 368 19 <sup>1</sup>	Triangle male 9 mm (EDF)	
10	0 368 20 <sup>1</sup>	Double bar	

<b>Key barrels</b>			
For Atlantic and Marina cabinets Supplied with set of 2 key			
10	0 368 22 <sup>1</sup>	For key No 405	
10	0 368 23 <sup>1</sup>	For key No 421	
10	0 368 24 <sup>1</sup>	For key No 455	
10	0 368 25 <sup>1</sup>	For key No 1242 E	
10	0 368 26 <sup>1</sup>	For key No 2433 A	
10	0 368 27 <sup>1</sup>	For key No 3113 A	
10	0 365 45 <sup>1</sup>	Set of two 2433 A keys Other key code: please consult us	

<b>Metal keys for rebate locks</b>			
10	0 365 35	Square female 6 mm	
10	0 365 39	Triangle male 6.5 mm	
10	0 365 40	Triangle male 8 mm	
10	0 365 41	Triangle male 9 mm (EDF)	
10	0 365 42	Double bar	
1	0 368 42	Multi-size key for rebate locks: square male 8 mm, square male 6 mm, Triangle male 8 mm and double bar	

1: Except Marina enclosures: please consult us

# Uprights, rails and fixing accessories for cabinets and enclosures

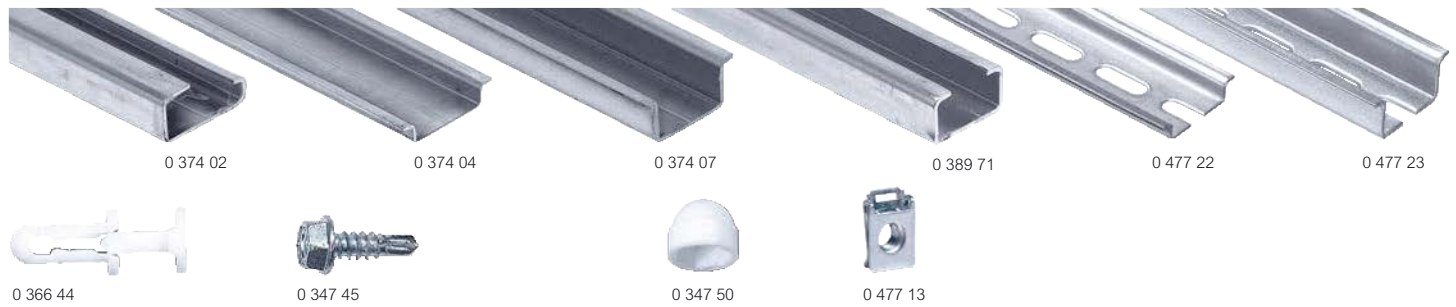

For mounting chassis and fixing wiring accessories

## Pack Cat.Nos Uprights to be cut

10	0 361 92	<b>Lina 25</b> Length 3 m - Section L
10	0 361 94	Length 2 m - Section L
10	0 389 71	<b>On C profile rail</b> Section C

## Rails to be cut

10	0 374 02	Length 2 m EN 60 715
10	0 374 04	EN 60 715 depth 7.5 mm
10	0 374 07	depth 15 mm
10	0 389 71	Section C
10	0 477 22	depth 7.5 mm with oblongs
10	0 477 23	depth 15 mm with oblongs

## 45° mounting bracket

10	0 394 49	Set of 2 supports for 45° rail slope Supplied with 4 M6 screws Ø6 mm, nuts and washers
----	----------	--

## Fixing accessories

100	0 347 46	<b>On plain plates</b> CBL Z 5.5 x 16 PZ No 3 self-tapping screw	
100	0 347 47	CBL Z 5.5 x 19 self-drilling tapping screw	
500	0 366 44 <sup>1</sup>	<b>On Lina 12.5 plates</b> Rivet reinforced plastic Ø6 mm for drilling Ø6.5 mm	
100	0 347 45	Screw head H 4.8 x 16 mm self-drilling, self-tapping for Ø3.3 mm	
200	0 347 50	Screw caps for isolation of screw head Cat.No 0 347 45	
100	0 364 40	<b>On Lina 25 perforated plates</b> Clip-nuts supplied without screw For M4 screws	
100	0 364 41	For M5 screws	
100	0 364 42	For M6 screws	
50	0 477 12	<b>On cabinet frame and crosspieces</b> Clip-nuts with pins which provide earth continuity For M6 screws	
50	0 477 13	For M8 screws	
100	0 364 61	<b>On rails EN 60 715</b> Fixobar for M4 screws	
100	0 364 62	Fixobar for M5 screws	
100	0 364 63	Fixobar for M6 screws	

## Pack Cat.Nos Fixing accessories (continued)

20	0 364 66	<b>Adaptor</b> For mounting on rail C equipment fitting on rail L Width 17 mm Increase equipment height of 6 mm	
100	0 364 78	<b>On rails EN 60 715</b> For M4 screws	
100	0 364 79	For M6 screws	
10	0 044 16	<b>On rails EN 60 715</b> Claw width 10 mm Threaded hole for M4 screw Claw width 17.5 mm Smooth hole 3.8 mm Supplied with fixing screw Ø3.5 mm Length 13 mm	
50	0 044 17		
100	0 374 39	Claw width 35 mm Holes for M4 and M6 screws	
40	0 364 69	Fixomega for M4 screws	
100	0 364 82	<b>On C profile rail</b> Stirrup for M6 screws	
20	0 364 50	<b>Cage nuts</b> For mounting on square perforation 8.3 x 8.3 mm M4	
20	0 364 51	M5	
20	0 364 52	M6	
50	0 367 75	<b>HF screw with contact washer</b> M 6-10 HF screws with contact washers	

1: Can also be used on Lina 25 perforated plate

# Heat regulation for cabinets and enclosures

## ventilators



0 348 17



0 348 52



exemple of plastic louvre mounted



0 348 54

Technical characteristics p. 265

Pack	Cat.Nos	Ventilators with metal louvre	Pack	Cat.Nos	Ventilators with plastic louvre (continued)
1	0 348 17	<p>IP 32 - IK 10 Ventilator is mounted on the outside of the enclosure or cabinet A second outlet can be installed to increase the flow rate and optimise discharge rates from the enclosure 230 V - 50/60 Hz</p> <p><b>30/160 m<sup>3</sup>/h :</b> 30 m<sup>3</sup> installed with filter 160 m<sup>3</sup> for free blow-out Supplied with a pair of metal louvres, a pair of anti-insect grilles and an internal finger-guard grille</p>	1	0 348 52	<p><b>240/450 m<sup>3</sup>/h</b> 240 m<sup>3</sup> installed with filter 260 m<sup>3</sup> with second louvre Cat.No 0 348 35 450 m<sup>3</sup> for free blow out Supplied with a pair of louvres 250 x 250 mm Media filter washable G3, acc. EN 779</p>
1	0 365 71	<p>RAL 7035 Beige RAL 7032</p>	1	0 348 53	<p><b>400/900 m<sup>3</sup>/h</b> 400 m<sup>3</sup> installed with filter 450 m<sup>3</sup> with second louvre Cat.No 0 348 36 900 m<sup>3</sup> for free blow out Supplied with a pair of 325 x 325 mm Media filter washable G3, acc. EN 779</p>
1	0 348 50	<p><b>Ventilators with plastic louvre</b></p> <p>IP 54 - IK 08 230 V - 50/60 Hz RAL 7035 Equipped with finger-guard grilles Reduced external dimensions (7 to 10 mm) Ventilator is mounted on the outside of the enclosure or cabinet Screw fixing on a panel width 1 to 4 mm A second outlet louvre can be installed to increase the flow rate and optimise discharge rates from the enclosure</p> <p><b>40/160 m<sup>3</sup>/h</b> 40 m<sup>3</sup> installed with filter 45 m<sup>3</sup> with second louvre Cat.No 0 348 34 160 m<sup>3</sup> for free blow out Supplied with a pair of louvres 150 x 150 mm equipped Electrostatic filter washable G3, acc. EN 779</p>	1	0 348 54	<p><b>550/1200 m<sup>3</sup>/h</b> 550 m<sup>3</sup> installed with filter 620 m<sup>3</sup> with second louvre Cat.No 0 348 36 1200 m<sup>3</sup> for free blow out Supplied with a pair of louvres 325 x 325 mm Media filter washable G3, acc. EN 779</p>
1	0 348 51	<p><b>120/160 m<sup>3</sup>/h</b> 120 m<sup>3</sup> installed with filter 130 m<sup>3</sup> with second louvre Cat.No 0 348 35 160 m<sup>3</sup> for free blow out Supplied with a pair of louvres 250 x 250 mm Media filter washable G3, acc. EN 779</p>			



# Heat regulation for cabinets and enclosures

## ventilators (continued)



0 365 74



0 348 08



0 365 77



0 365 79



0 348 05



0 348 35



Technical characteristics p. 265

Pack	Cat.Nos	<b>Air circulation kit 160 m<sup>3</sup>/h</b>																				
1	0 365 74	230 V~ - 50/60 Hz Uniformizes temperature in enclosure Prevent hot spots Plate or rail mounting in bottom part of enclosure or under most sensitive equipment The air flow must be directed upward																				
		<b>Roof ventilators</b>																				
		Plastic - RAL 7035 Provide very high extraction rate Screw mounting on top of enclosures Dimensions: 400 x 350 x 100 mm Delivered without input air louvre IP 23 - IK 08 With motor																				
		<table border="1"> <thead> <tr> <th>Free blowing (m<sup>3</sup>/h)</th> <th>Flow rate (m<sup>3</sup>/h) with 1 louvre</th> <th>Flow rate (m<sup>3</sup>/h) with 2 louvres</th> <th>Flow rate (m<sup>3</sup>/h) with 1 louvre</th> <th>Flow rate (m<sup>3</sup>/h) with 2 louvres</th> </tr> <tr> <th></th> <th>Cat.No 0 348 35</th> <th>Cat.No 0 348 35</th> <th>Cat.No 0 348 36</th> <th>Cat.No 0 348 36</th> </tr> </thead> <tbody> <tr> <td>600</td> <td>350</td> <td>400</td> <td>400</td> <td>450</td> </tr> <tr> <td>1000</td> <td>400</td> <td>500</td> <td>500</td> <td>600</td> </tr> </tbody> </table>	Free blowing (m <sup>3</sup> /h)	Flow rate (m <sup>3</sup> /h) with 1 louvre	Flow rate (m <sup>3</sup> /h) with 2 louvres	Flow rate (m <sup>3</sup> /h) with 1 louvre	Flow rate (m <sup>3</sup> /h) with 2 louvres		Cat.No 0 348 35	Cat.No 0 348 35	Cat.No 0 348 36	Cat.No 0 348 36	600	350	400	400	450	1000	400	500	500	600
Free blowing (m <sup>3</sup> /h)	Flow rate (m <sup>3</sup> /h) with 1 louvre	Flow rate (m <sup>3</sup> /h) with 2 louvres	Flow rate (m <sup>3</sup> /h) with 1 louvre	Flow rate (m <sup>3</sup> /h) with 2 louvres																		
	Cat.No 0 348 35	Cat.No 0 348 35	Cat.No 0 348 36	Cat.No 0 348 36																		
600	350	400	400	450																		
1000	400	500	500	600																		
1	0 348 07																					
1	0 348 08																					

Pack	Cat.Nos	<b>Natural ventilation</b>
2	0 365 77	<b>IP 66 - IK 08 ventilation glands for cabinets</b> Polyamide PA 6 - RAL 7035 Drilling Ø40.5 mm
2	0 365 78	<b>IP 44 - IK 08 ventilation glands for cabinets</b> For outdoor use Grey polyamide 6.6 Drilling Ø15 mm
2	0 365 79	Drilling Ø30.5 mm
		<b>Metal louvres</b>
		IP 32 - IK 10
1	0 348 04	Set of 2 metal louvres + 2 anti-insect grilles RAL 7035 - 138 x 138 mm
1	0 365 70	Beige RAL 7032 - 138 x 138 mm
1	0 348 05	RAL 7035 - 248 x 248 mm
1	0 348 16	Beige RAL 7032 - 248 x 248 mm
		<b>Plastic louvres</b>
		RAL 7035
		Supplied singly
1	0 348 34	IP 44 - 150 x 150 mm
1	0 348 35	IP 54 - 250 x 250 mm
1	0 348 36	IP 54 - 325 x 325 mm



Exchangers, air conditioners,  
**Please, consult us**



# Heat regulation for cabinets and enclosures

## heating and regulation



Technical characteristics **p. 266**  
Sizing of heat regulation **see XL Pro<sup>3</sup>**

Pack	Cat.Nos	Heating												
		IP 20 Class II Prevent condensation forming inside the enclosure «PTC» auto-regulated and self-limited surface temperature < 85 °C Connection on terminals Mounting on rail												
		Heat dissipator in aluminium under plastic UL 94 VO												
		<b>Resistance heaters 120 V/240 V~/=</b>												
		<table border="1"> <thead> <tr> <th>Power (W)</th> <th>Start-up current (A)</th> </tr> </thead> <tbody> <tr> <td>20</td> <td>2.5</td> </tr> <tr> <td>50</td> <td>2.5</td> </tr> <tr> <td>100</td> <td>4.5</td> </tr> <tr> <td>150</td> <td>8.0</td> </tr> </tbody> </table>	Power (W)	Start-up current (A)	20	2.5	50	2.5	100	4.5	150	8.0		
Power (W)	Start-up current (A)													
20	2.5													
50	2.5													
100	4.5													
150	8.0													
1	0 353 06													
1	0 353 07													
1	0 353 08													
1	0 353 09													
		<b>Pulsated air resistance heaters 230 V~</b>												
		Built-in temperature limiter Material: Polycarbonate UL 94 VO												
		<table border="1"> <thead> <tr> <th>Power (W)</th> <th>Start-up current (A)</th> <th>Thermostat</th> <th>Fan flow rate (m<sup>3</sup>/h)</th> </tr> </thead> <tbody> <tr> <td>150</td> <td>12</td> <td>without</td> <td>13</td> </tr> <tr> <td>350</td> <td>7.5</td> <td>0 to 60 °C with LED</td> <td>35</td> </tr> </tbody> </table>	Power (W)	Start-up current (A)	Thermostat	Fan flow rate (m <sup>3</sup> /h)	150	12	without	13	350	7.5	0 to 60 °C with LED	35
Power (W)	Start-up current (A)	Thermostat	Fan flow rate (m <sup>3</sup> /h)											
150	12	without	13											
350	7.5	0 to 60 °C with LED	35											
1	0 353 10													
1	0 348 06													

Pack	Cat.Nos	Regulation
		IP 20
		<b>Thermostats</b>
		Precision 0.5 °C (neutral connected) Switching and control range: 2 °C 230 V - 50/60 Hz NO contact: 5 A, 250 V~ NC contact: 10 A, 250 V~ Can be set to between 5 and 60 °C with NC and NO contact
1	0 348 47	Mounted on rail
		<b>Hygrostat</b>
1	0 353 11	For adjusting the relative humidity inside a cabinet or an enclosure to avoid the formation of condensation by starting up a heater or a fan 230 V~, 50/60 Hz NO contact: 6 A, 240 V~, 4 A, 24 V= NC contact: 8 A, 240 V~, 4 A, 24 V= Mounted on rail Adjustable from 35 % to 100 % relative humidity

Pack	Cat.Nos	Regulation (continued)
1	0 353 12	<b>Hygrothermostat</b> For independent adjustment of the temperature and humidity level inside a cabinet or an enclosure, to avoid the formation of condensation by starting up a heater or a fan 230 V~, 50/60 Hz NO contact: 6 A - 240 V~, 4 A - 24 V= NC contact: 8 A, 240 V~, 4 A, 24 V= For fixing on rail Adjustable from 0 °C to 60 °C and from 50 % to 90 % relative humidity
1	0 363 13	<b>Door contact</b> For example, to cut off the air conditioning and the lighting supply as soon as the enclosure or cabinet door is opened 3 A - 240 V 1 NC contact + 1 NO contact For Atlantic, Atlantic-E and Marina cabinets Supplied with fixing lug

# Heat regulation for cabinets and enclosures

## ventilators

### Principle of operation

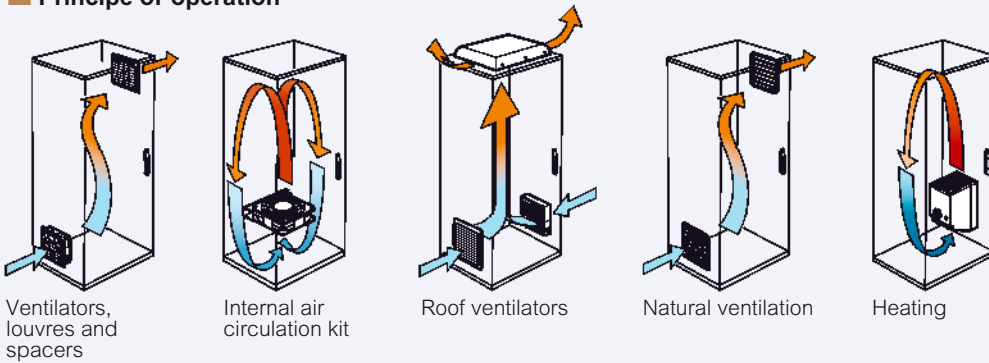

### Ventilators, louvres and spacers

#### Dimensions and cut-out

Cat.Nos 0 365 71 and 0 348 17

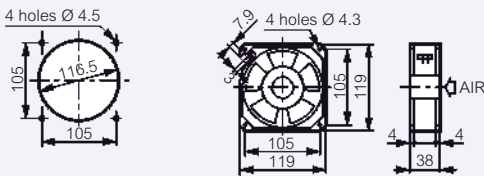

Cat.Nos 0 348 50/51/52/53/54/34/35/36

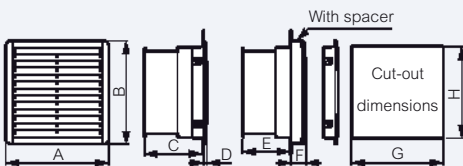

Cat.Nos	A	B	C	D	E	F	G	H
0 348 50	150	150	70	7	43	34	125	125
0 348 51	250	250	105	8	78	35	223	223
0 348 52	250	250	123	8	96	35	223	223
0 348 53	325	325	152	10	125	37	291	291
0 348 54	325	325	115	10	88	37	291	291
0 348 34	150	150	-	7	-	34	125	125
0 348 35	250	250	-	8	-	35	223	223
0 348 36	325	325	-	10	-	37	291	291

#### Technical characteristics

Cat.Nos	0 365 71/0 348 17	0 348 50	0 348 51	0 348 52	0 348 53	0 348 54
Voltage (V) / phase	220-240/1	230/1	230/1	220-240/1	220-240/1	230/1
Frequency (Hz)	50/60	50/60	50/60	50/60	50/60	50/60
No load flow ventilator only (m³/h)	160	160	160	450	900	1200
On load flow with an output louvre (supplied)	30	40	120	240	400	550
Static pressure (mm of water)	100	66	51	111	160	186
Power down (W)	22	20	20	29	67	114
Current drawn (A)	0.14	0.125	0.125	0.426	0.3	0.5
Operating temperature	-10°C/+50°C					
IP/IK	32/10	54/08	54/08	54/08	54/08	54/08
Sound level (dB)	49	43	43	50	61	71
Weight (kg)	0.72	0.8	1.4	1.7	3.6	3.7

### Internal air circulation kit

#### Dimensions

Cat.No 0 365 74

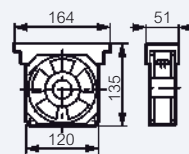

#### Technical characteristics

Cat.No	Circulation kit 50/60 Hz							
	Rated speed (rpm)	Max. flow rate (m³/hr)	Static pressure (mm of water)	Power drawn (W)	Current drawn (mA)	Operating temperature (°C)	Noise (dB A)	Weight (kg)
0 365 74	2750	160	10	18	135	-10/+55	44	0.55

### Roof ventilators

#### Technical characteristics

Cat.Nos	Max. flow rate (m³/hr)	Power drawn (W)	Current drawn (mA)	Operating temperature (°C)	Noise (dB A)	Weight (kg)
0 348 07	600	70	0.32	50	64	4.1
0 348 08	1000	180	0.5	50	72	4.3

### Natural ventilation

#### Dimensions and cut-out

Cat.Nos 0 365 70 and 0 348 04

Cat.Nos 0 348 16 and 0 348 05

Cat.No 0 365 79

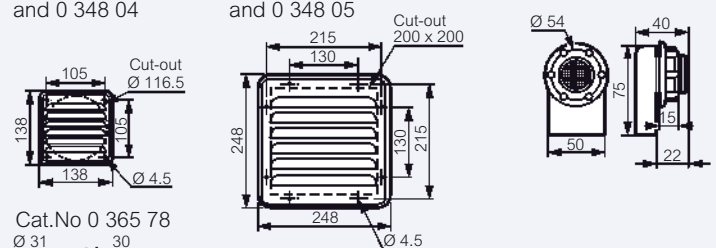

Cat.No 0 365 78

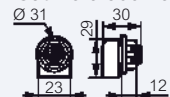

Cat.No 0 365 77

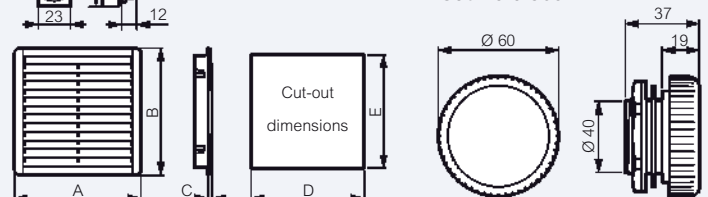

Cat.Nos	A	B	C	D	E
0 348 34	150	150	7	125	125
0 348 35	250	250	8	223	223
0 348 36	325	325	10	291	291

# Heat regulation for cabinets and enclosures

## Dimensions (mm)

Cat.Nos 0 353 06/07/08/09

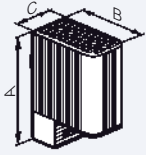

Cat.Nos	Power	A	B	C
0 353 06	20 W	98	75	38
0 353 07	50 W	110	90	60
0 353 08	100 W	110	90	60
0 353 09	150 W	150	90	60

Cat.No 0 353 10

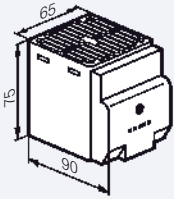

Cat.No 0 353 12

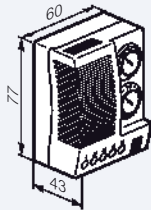

Cat.No 0 348 06

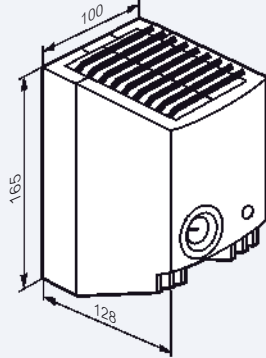

Cat.Nos 0 348 47/48 and 0 353 11

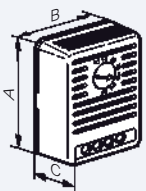

Cat.Nos	A	B	C
0 348 47	67	51	34
0 348 48	67	51	34
0 353 11	64	43	34

Vertical mounting at the bottom of the cabinet:  
 Recommended clearance around heat regulation products for optimal air circulation :  
 - for Cat.Nos 0 348 47 and 0 353 11/12 > 50 mm  
 - for Cat.Nos 0 348 06 and 0 353 10 > 150 mm or more for sensitive devices  
 - do not cover

## Wiring diagram

Cat.Nos 0 353 07/08/09

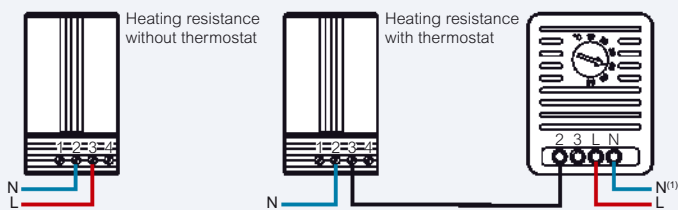

Cat.No 0 353 06

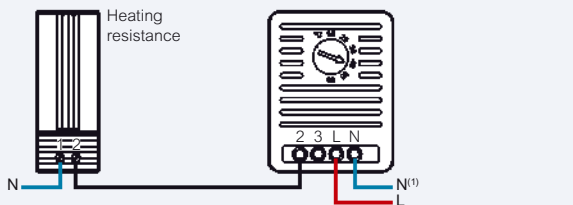

## Wiring diagram (continued)

Cat.No 0 353 10

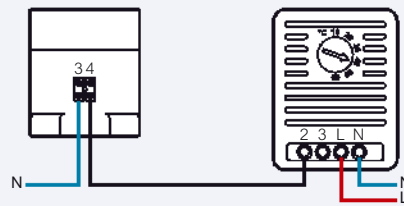

Thermostat Cat.Nos 0 348 47/48

Ventilator

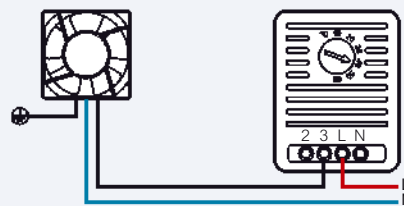

Thermostat Cat.Nos 0 348 47/48

Cat.No 0 353 11

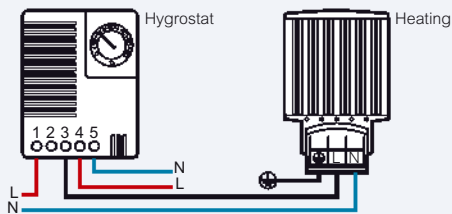

Cat.No 0 353 12

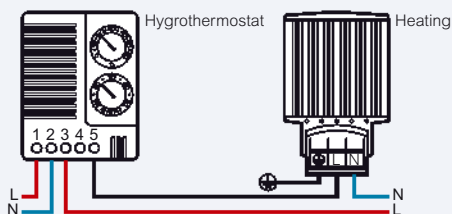

1: Connection accelerating resistance

## Plastic cable glands IP 55

ISO and PG



Pack	Cat.Nos	Grey RAL 7035 cable glands		
		Cable gland with flexible blades designed for commercial applications that require IP 55 protection and a good hold on the cables		
		<b>ISO</b>		
		Conform to EN 50262		
		ISO	Clamping capacity	
			Ø Min. (mm)	Ø Max. (mm)
50	0 968 00	12	4	6.5
50	0 968 01	16	5	10
50	0 968 03	20	10	14
50	0 968 05	25	13	18
25	0 968 06	32	18	25
10	0 968 07	40	22	32
10	0 968 08	50	30	38
10	0 968 09	63	34	44

Pack	Cat.Nos	Grey RAL 7035 locking nuts		
		Cable gland with flexible blades designed for commercial applications that require IP 55 protection and a good hold on the cables		
		<b>ISO</b>		
		Conform to UTE C 68-300 and 68-311 guides recommendations		
		PG	Clamping capacity	
			Ø Min. (mm)	Ø Max. (mm)
50	0 968 20	7	3.5	6
50	0 968 21	9	4	8
50	0 968 22	11	5	10
50	0 968 23	13.5	7	12
50	0 968 24	16	10	14
50	0 968 25	21	13	18
25	0 968 26	29	18	25
10	0 968 27	36	22	32
10	0 968 28	42	30	38
10	0 968 29	48	34	44

Pack	Cat.Nos	Grey RAL 7035 locking nuts		
		Cable gland with flexible blades designed for commercial applications that require IP 55 protection and a good hold on the cables		
		<b>ISO</b>		
		Conform to UTE C 68-300 and 68-311 guides recommendations		
		PG	Clamping capacity	
			Ø Min. (mm)	Ø Max. (mm)
50	0 968 40	7	3.5	6
50	0 968 41	9	4	8
50	0 968 43	11	5	10
50	0 968 45	13.5	7	12
25	0 968 46	16	10	14
10	0 968 47	21	13	18
10	0 968 48	29	18	25
10	0 968 49	36	22	32
		<b>PG</b>		
50	0 968 30	7	3.5	6
50	0 968 31	9	4	8
50	0 968 32	11	5	10
50	0 968 33	13.5	7	12
50	0 968 34	16	10	14
50	0 968 35	21	13	18
25	0 968 36	29	18	25
10	0 968 37	36	22	32
10	0 968 38	42	30	38
10	0 968 39	48	34	44

RTA conduit system brochure available on request



## Plastic cable glands IP 55

ISO and PG

### Cable glands

#### Characteristics

Halogen-free polyamide UL 94-V2  
 Operating temperature: - 20 °C to + 80 °C  
 Self-extinguishing 650 °C according to IEC 60695-2-11

#### Dimensions (mm)

ISO		Cat.Nos	Threading	A max.	B	Ø D	C to flat	Ø E	Drilling Ø
	0 968 00	ISO 12	23	8	19	16	11.8	12.7	
	0 968 01	ISO 16	28	15	25	22	15.8	16.2	
	0 968 03	ISO 20	34	15	29	26	19.9	20.4	
	0 968 05	ISO 25	36	15	35	30	24.8	25.4	
	0 968 06	ISO 32	40	15	46	42	31.6	32.5	
	0 968 07	ISO 40	47	18	53	52	39.8	40.5	
	0 968 08	ISO 50	48	18	65	58	49.8	50.8	
	0 968 09	ISO 63	55	18.5	71	66	62.6	64	

PG		Cat.Nos	Threading	A max.	B	Ø D	C to flat	Ø E	Drilling Ø
	0 968 20	PG 7	23	8	17	15	12.1	12.7	
	0 968 21	PG 9	27	8	22	19	15.1	15.2	
	0 968 22	PG 11	31	8	25	22	18.2	18.6	
	0 968 23	PG 13.5	32	9	27	24	20.2	20.4	
	0 968 24	PG 16	32	10	29	27	22.3	22.5	
	0 968 25	PG 21	35	11	39	33	28.1	28.3	
	0 968 26	PG 29	41	11	46	42	36.9	37	
	0 968 27	PG 36	50	14.5	59	53	46.4	47	
	0 968 28	PG 42	52	14.5	66	59	53.5	54	
	0 968 29	PG 48	52	15.5	70	64	59.9	60	

### Locking nuts

Glass fiber polyamide

#### Dimensions (mm)

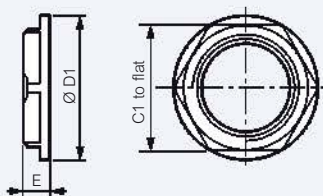

ISO		Cat.Nos	Threading	C1 to flat	E	Ø D1
	0 968 40	ISO 12	17	5	19	
	0 968 41	ISO 16	22	5	24	
	0 968 43	ISO 20	26	6	28	
	0 968 45	ISO 25	32	6	35	
	0 968 46	ISO 32	42	7	46	
	0 968 47	ISO 40	50	7	56	
	0 968 48	ISO 50	60	8	66	
	0 968 49	ISO 63	75	8	81	

PG		Cat.Nos	Threading	C1 to flat	E	Ø D1
	0 968 30	PG 7	19	5	21	
	0 968 31	PG 9	22	5	24	
	0 968 32	PG 11	24	5	26	
	0 968 33	PG 13.5	26	6	28	
	0 968 34	PG 16	32	6	35	
	0 968 35	PG 21	36	7	38	
	0 968 36	PG 29	46	7	51	
	0 968 37	PG 36	60	8	66	
	0 968 38	PG 42	64	8	72	
	0 968 39	PG 48	69	8	77	

## Plastic cable glands IP 68

ISO and PG



Pack	Cat.Nos	Grey RAL 7001 cable glands		
		Anti-vibration mechanically tightened cable gland with neoprene weatherproof seal for IP 68 protection Locking part consisting of flexible blades which exert strong pressure on the cable thus giving the product excellent tensile strength Supplied with surface seal and locking nut mounted		
		<b>ISO</b>		
		Conform to EN 50 262		
			Clamping capacity	
		ISO	Ø Min. (mm)	Ø Max. (mm)
25	0 980 00	12	3	6.5
25	0 980 01	16	4	8
25	0 980 03	20	6	12
10	0 980 05	25	12	18
5	0 980 06	32	18	25
3	0 980 07	40	22	32
2	0 980 08	50	30	38
2	0 980 09	63	34	44

		<b>PG</b>		
		Conform to UTE C 68-300 and 68-311 guides recommendations		
			Clamping capacity	
		PG	Ø Min. (mm)	Ø Max. (mm)
25	0 980 20	7	3	6.5
25	0 980 21	9	4	8
25	0 980 22	11	5	10
25	0 980 23	13.5	6	12
20	0 980 24	16	10	14
10	0 980 25	21	12	18
5	0 980 26	29	18	25
3	0 980 27	36	22	32
2	0 980 28	42	30	38
2	0 980 29	48	34	44

		<b>Grey RAL 7001 stopping plugs - ISO</b>		
		Hexagonal with base ensuring the IP protection of the enclosure Can be tightened using a flat screwdriver Supplied with surface seal Nuts to be ordered separately		
50	0 980 41	ISO 16		
50	0 980 43	ISO 20		
50	0 980 45	ISO 25		
25	0 980 46	ISO 32		
25	0 980 47	ISO 40		

## Plastic cable glands IP 68

### Cable glands

#### Characteristics

Halogen-free polyamide UL 94-V2  
Operating temperature: - 20 °C to + 80 °C  
Self-extinguishing 850 °C according to IEC 60695-2-11

#### Dimensions (mm)

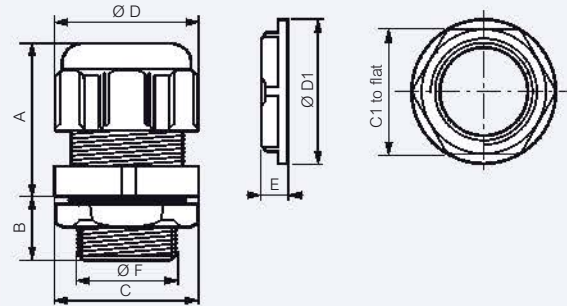

#### ISO

Cat.Nos	Threading	A	B	Ø D	C (to flat)	Ø F	Drilling Ø	C1	E	Ø D1
0 980 00	ISO 12	22	10	16.8	15	11.9	12.7	19	5	21
0 980 01	ISO 16	26	10	21	19	15.9	16.2	22	5	24
0 980 03	ISO 20	29	12	26.5	24	19.8	20.4	26	6	28
0 980 05	ISO 25	35	15	36	33	24.8	25.4	32	6	35
0 980 06	ISO 32	40	15	46.5	42	31.6	32.5	42	7	43
0 980 07	ISO 40	49	17	58.5	53	39.9	40.5	50	7	56
0 980 08	ISO 50	54	17	66.5	60	50	50.8	60	8	66
0 980 09	ISO 63	54	18	75	68	62.9	64	75	8	82

#### PG

Cat.Nos	Threading	A	B	Ø D	C (to flat)	Ø F	Drilling Ø	C1	E	Ø D1
0 980 20	PG 7	22	10	16.8	15	12.5	12.7	19	5	21
0 980 21	PG 9	26	10	21	19	15.2	15.2	22	5	24
0 980 22	PG 11	27	12	24.5	22	18.6	18.6	24	5	26
0 980 23	PG 13.5	29	12	26.5	24	20.4	20.4	26	6	28
0 980 24	PG 16	30	13	29.5	27	22.5	22.5	32	6	35
0 980 25	PG 21	35	15	36	33	28.3	28.3	36	7	38
0 980 26	PG 29	40	15	46.5	42	37	37	46	7	51
0 980 27	PG 36	49	17	58.5	53	47	47	60	8	66
0 980 28	PG 42	54	17	66.5	60	54	54	70	8	78
0 980 29	PG 48	54	18	75	68	60	60	75	8	82

### Stopping plugs

Polyamide

#### Dimensions (mm)

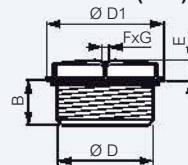

Cat.Nos	Threading	Ø D	D1	F X G	B	E
0 980 41	ISO 16	15.8	20.5	8 x 2	12	3.9
0 980 43	ISO 20	19.8	25	8 x 2	12	3.8
0 980 45	ISO 25	24.8	30.5	8 x 2	12	4.4
0 980 46	ISO 32	31.8	38	8 x 2	12	4.9
0 980 47	ISO 40	39.8	46.5	8 x 2	12.5	4.9

## Metal cable glands IP 68

ISO and PG



0 955 05



0 955 09



0 955 16

### Pack Cat.Nos Metal cable glands

Mechanically tightened cable glands with neoprene weatherproof seal for IP 68 protection. Locking part consisting of flexible blades which exert strong pressure on the cable thus giving the product excellent tensile strength  
Supplied with surface seal mounted

#### ISO

Conform to EN 50262

Pack	Cat.Nos	ISO	Clamping capacity	
			Ø Min. (mm)	Ø Max. (mm)
20	0 955 01	16	5.5	9.5
20	0 955 03	20	7	13
10	0 955 05	25	8	16
5	0 955 06	32	11	21
5	0 955 07	40	15	27
2	0 955 08	50	22	35
2	0 955 09	63	35	48

#### PG

Conform to UTE C 68-300 and 68-312 guides recommendations

Pack	Cat.Nos	PG	Clamping capacity	
			Ø Min. (mm)	Ø Max. (mm)
20	0 955 10	7	3	6.5
20	0 955 11	9	4	9
20	0 955 12	11	6	11.5
20	0 955 13	13.5	7	13
20	0 955 14	16	10	15
10	0 955 15	21	11	19
10	0 955 16	29	16	26
10	0 955 17	36	22	34.5
2	0 955 18	42	27	40
2	0 955 19	48 DIN	35	48

### Metal locking nuts

#### ISO

50	3 866 31	ISO 16
50	3 866 32	ISO 20
50	3 866 33	ISO 25
50	3 866 34	ISO 32
25	3 866 35	ISO 40
10	3 866 36	ISO 50
10	3 866 37	ISO 63

#### PG

50	3 866 21	PG 7
50	3 866 22	PG 9
50	3 866 23	PG 11
50	3 866 24	PG 13.5
50	3 866 25	PG 16
50	3 866 26	PG 21
25	3 866 27	PG 29
25	3 866 28	PG 36
10	3 866 29	PG 42
10	3 866 30	PG 48

## Metal cable glands IP 68

### Cable glands

#### Characteristics

Nickel-plated brass (locking part in polyamide)  
Operating temperature : - 25 °C + 85 °C

#### Dimensions (mm)

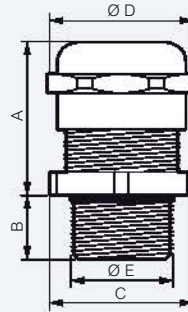

Cat.Nos	Threading	A max.	B	Ø D	C (to flat)	Ø E	Drilling Ø
0 955 01	ISO 16	25	5	19	17	15.9	16.2
0 955 03	ISO 20	27	6	24	22	19.8	20.4
0 955 05	ISO 25	27	7	30	27	24.6	25.4
0 955 06	ISO 32	31	8	36	34	31.6	32.5
0 955 07	ISO 40	34	8	46	42	39.7	40.5
0 955 08	ISO 50	37	9	60	55	49.7	50.8
0 955 09	ISO 63	45	10	70	65	62.6	64

Cat.Nos	Threading	A max.	B	Ø D	C (to flat)	Ø E	Drilling Ø
0 955 10	PG 7	21	5	15.6	14	12.4	12.7
0 955 11	PG 9	25	6	19	17	15.1	15.2
0 955 12	PG 11	25	6	22	20	18.4	18.6
0 955 13	PG 13.5	26	6.5	24	22	20.3	20.4
0 955 14	PG 16	28	6.5	26.6	24	22.4	22.5
0 955 15	PG 21	32	7	33	30	27.7	28.3
0 955 16	PG 29	36	8	44	40	36.9	37
0 955 17	PG 36	39	9	55.6	50	46.9	47
0 955 18	PG 42	42	10	63	58	54	54
0 955 19	PG 48	44	10	69.5	65	60	60

### Locking nuts

Nickel-plated brass

#### Dimensions (mm)

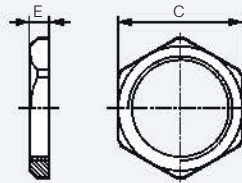

#### ISO

Cat.Nos	Threading	C	E
3 866 31	ISO 16	19	3
3 866 32	ISO 20	24	3.5
3 866 33	ISO 25	30	4
3 866 34	ISO 32	36	4
3 866 35	ISO 40	46	5
3 866 36	ISO 50	60	5
3 866 37	ISO 63	70	6

#### PG

Cat.Nos	Threading	C	E
3 866 21	PG 7	15	2.8
3 866 22	PG 9	18	2.8
3 866 23	PG 11	21	3
3 866 24	PG 13.5	23	3
3 866 25	PG 16	26	3
3 866 26	PG 21	32	3.5
3 866 27	PG 29	41	4
3 866 28	PG 36	51	5
3 866 29	PG 42	60	6
3 866 30	PG 48	65	6.5



# EQUIPMENT & ACCESSORIES

## Cabling components & marking systems



**P. 272**  
Colring cable ties



**P. 292**  
Starfix ferrules & crimping tools

## Control and signalling devices, transformers & power supplies



**P. 302**  
Osmoz non-illuminated heads control & signalling units



**P. 312**  
Control & circuit isolation transformers

## Industrial sockets & other equipment



**NEW**  
**P. 326**  
P 17 Tempra Pro IP 44 - 16/32 A industrial sockets & plugs



**P. 339**  
P 17 Tempra interlocked switched sockets

## NEW PRODUCTS 2014



**IP 55 transformers and auto-transformers**  
(p. 314)



**P 17 Tempra Pro**  
industrial sockets & plugs  
(p. 326)





**P. 280**  
Viking 3 terminal blocks with screw connection



**P. 282**  
Viking 3 terminal blocks with spring connection



**P. 284**  
Accessories for Viking 3 terminal blocks



**P. 290**  
Viking 3 power terminal blocks



**P. 294**  
CAB 3 marking system



**P. 297**  
Memocab marking system



**P. 299**  
Transcab cable ducting



**P. 300**  
Lina 25 cable ducting



**P. 303**  
Osmoz illuminated heads control & signalling units



**P. 308**  
Cam switches



**P. 311**  
Selective measurement switches



**NEW**  
**P. 312**  
Control & safety transformers



**P. 313**  
Equipment transformers



**NEW**  
**P. 314**  
IP 55 transformers & auto-transformers



**P. 322**  
Filtered & rectified power supplies



**P. 327**  
P 17 Tempra ELV IP 44 - 16/32 A industrial sockets & plugs



**P. 328**  
P 17 Tempra Pro IP 66/67 - 16/32 A industrial sockets & plugs



**P. 329**  
P 17 Tempra IP 66/67 - 63/125 A industrial sockets & plugs



**P. 336**  
P 17 Tempra combined units to be composed



**P. 340**  
Hypra IP 44 16/32/63 A industrial sockets & plugs



**P. 342**  
Hypra IP 66/67 16/32/63/125 A industrial sockets & plugs



**P. 348**  
Bells for industrial & alarm use



0 320 42 blister packing



0 320 61/14/31/19/20/49



(see p. 826)

**Technical characteristics p. 274**

For series assembly of electrical cables  
With self blocking head and internal teeth  
Conform to EN 62275 type 1 (NFC 68-146)

Pack	Cat.Nos	Colring colourless cable ties			
		<b>Blister packing 100 pcs</b>			
		Width (mm)	Flat length (mm)	Ø grip capacity (mm)	
				Max.	Min.
1000/10000	0 320 30	2.4	95	18	1.6
1000/10000	0 320 31	2.4	140	33	1.6
1000/6000	0 320 32	2.4	180	46	1.6
1000/4000	0 320 37	3.5	140	33	1.6
1000/4000	0 320 38	3.5	180	46	1.6
100/2000	0 320 39	3.5	280	77	1.6
100/2000	0 320 40	3.5	360	102	1.6
1000/4000	0 320 42	4.6	180	46	1.6
100/2000	0 320 43	4.6	280	77	1.6
100/2000	0 320 44	4.6	360	102	1.6
100/1000	0 320 47 <sup>3</sup>	7.6	180	42	4.8
100	0 320 49 <sup>3</sup>	7.6	360	98	4.8
100	0 320 50 <sup>3</sup>	7.6	720	218	4.8
100/1000	0 320 45 <sup>2</sup>	7.6	550	166	4.8
100/1000	0 320 46 <sup>2</sup>	9	760	218	14
100/500	0 320 48 <sup>2</sup>	9	810	246	14
50/500	0 320 51 <sup>2</sup>	12.6	1030	317	20
		<b>Sachet packing 100 pcs</b>			
		Except Cat.No 0 318 38: 50 pcs			
8000	0 318 20	2.4	95	18	1.6
4000	0 318 21	2.4	140	33	1.6
4000	0 318 22	2.4	180	46	1.6
4000	0 318 23	3.5	140	33	1.6
4000	0 318 24	3.5	180	46	1.6
4000	0 318 25	3.5	280	77	1.6
3000	0 318 26	3.5	360	102	1.6
4000	0 318 27	4.6	180	46	1.6
3000	0 318 28	4.6	280	77	1.6
2500	0 318 29	4.6	360	102	1.6
100	0 318 33	4.6	430	125	1.6
1200	0 318 30	7.6	180	42	4.8
1500	0 318 34	7.6	290	78	4.8
1000	0 318 31	7.6	360	98	4.8
100	0 318 35	7.6	550	166	4.8
100	0 318 32 <sup>1</sup>	7.6	720	218	4.8
100	0 318 36	9	710	218	14
100	0 318 37	9	810	246	14
500	0 318 38	12.6	1030	317	20

Pack	Cat.Nos	Identification colourless cable ties			
		<b>Sachet packing 100 pcs</b>			
		Width (mm)	Flat length (mm)	Ø grip capacity (mm)	
				Max.	Min.
100/3000	0 320 61 <sup>1</sup>	2.4	95	18	4
100/2500	0 320 63 <sup>1</sup>	4.6	180	46	9.5
		<b>Colring black cable ties</b>			
		High temperature UV protected			
		<b>Blister packing 100 pcs</b>			
		Except Cat.Nos 0 320 25 to 0 320 29: Sachet packing (50 pcs for Cat.No 0 320 28)			
		Width (mm)	Flat length (mm)	Ø grip capacity (mm)	
				Max.	Min.
1000	0 320 12	2.4	95	18	1.6
1000	0 320 13	2.4	140	33	1.6
1000	0 320 14	2.4	180	46	1.6
1000	0 320 15	3.5	140	33	1.6
1000	0 320 18	3.5	180	46	1.6
100/2000	0 320 19	3.5	280	77	1.6
100/2000	0 320 20	3.5	360	102	1.6
1000	0 320 22	4.6	180	46	1.6
100/2000	0 320 23	4.6	280	77	1.6
100/2000	0 320 24	4.6	360	102	1.6
100/2000	0 320 29 <sup>3</sup>	7.6	360	98	4.8
100	0 320 25 <sup>2</sup>	7.6	550	166	4.8
100	0 320 26 <sup>2</sup>	9	760	218	14
100	0 320 27 <sup>2</sup>	9	810	246	14
500	0 320 28 <sup>2</sup>	12.6	1030	317	20
		<b>Sachet packing 100 pcs</b>			
		Except Cat.No 0 318 18: 50 pcs			
8000	0 318 00	2.4	95	18	1.6
4000	0 318 01	2.4	140	33	1.6
4000	0 318 02	2.4	180	46	1.6
4000	0 318 03	3.5	140	33	1.6
4000	0 318 04	3.5	180	46	1.6
4000	0 318 05	3.5	280	77	1.6
3000	0 318 06	3.5	360	102	1.6
4000	0 318 07	4.6	180	46	1.6
3000	0 318 08	4.6	280	77	1.6
2500	0 318 09	4.6	360	102	1.6
100	0 318 13	4.6	430	125	1.6
100	0 318 10	7.6	180	42	4.8
1500	0 318 14	7.6	290	78	4.8
1000	0 318 11	7.6	360	98	4.8
100	0 318 15	7.6	550	166	4.8
100	0 318 12 <sup>1</sup>	7.6	720	218	4.8
100	0 318 16	9	710	218	14
100	0 318 17	9	810	246	14
500	0 318 18	12.6	1030	317	20

1: Non orientated head  
2: Sachet packing 100 pcs  
3: Non orientated head and sachet packing 100 pcs



## Colring™ accessories for equipment cable ties



Pack	Cat.Nos	Colring tool
1	0 320 88	P. 46 Colring tool for cable ties max. width 4,6 mm Direct adjustment of clamping tension by using the milled screw at the base of handle After clamping, a blade automatically cuts the surplus length close to the head without leaving a burr For cable ties width 7,6 and 9 mm, use Colson tool Cat.No 0 319 96 (p. 570)
		<b>Bases</b>
100/2000	0 320 65	<b>Self-adhesive</b> Possibility to screw fixing Ø4 mm Colourless - 25 x 30 x 6 mm For cable ties max. width 4.6 mm
100/2000	0 320 67	Black - 25 x 30 x 6 mm For cable ties max. width 4.6 mm
50	0 320 68	Black - 38 x 38 x 9.4 mm For cable ties max. width 20 mm
		<b>Screw-mounting</b> Colourless
1000	0 320 70	For cable ties max. width 4.6 mm 15 x 10 x 6 mm - Screw fixing Ø4 mm
100	0 320 72	For cable ties max. width 9 mm 21 x 16.5 x 8.8 mm - Screw fixing Ø5 mm
		<b>Clip-on</b>
1000	0 320 76	For cable ties max. width 4.6 mm For th. 0.5 to 3 mm, drilling Ø6 to 6.5 mm Mounting on Lina 12.5 plates for cabinets and enclosures and on Lina 25 plates for cabinets (p. 256)
		<b>Marking accessories</b>
100	0 320 85	White identification plate 38.5 x 19 mm for cable ties max. width 4.6 mm
10	0 395 98	Use felt tip pen Cat.No 0 395 98 for marking Black felt tip pen Indelible for marking



## COLRING EQUIPMENT CABLE TIES

# Easy to use cable ties for wires, cables or marking systems

Designed for assembly in series of wires or electrical cables, with self-blocking head and internal teeth, Colring cable ties and accessories simplify your work and save your time.

Marking systems allow a perfect identification of the circuits.



Duplix system p. 571

### DUPLIX MARKING SYSTEM

Opened or closed marking system with markers or labels. Fitted using 2.4 and 3.5 mm Colring cable ties.



Identification plates p. 273

### IDENTIFICATION PLATES

White identification plates 38.5 x 19 mm Fitted using 4.6 mm Colring cable ties.



Viking 3 terminal blocks p. 276



Colson cable ties p. 570



## Performance

Conform to EN 62275 type 1 (NFC 68-146)  
 "cable ties for electrical installations"  
 Recognized by UL 1565 approval

### Ratchet / tensile strength and temperature resistance

Cat.Nos	Ratchet force (daN)	Tensile strength according to EN 50146		Temperature resistance		
		test (mm)	Min tensile strength (daN)	Max. operating temperature (°C)	Min. operating temperature (°C)	Min. installation temperature (°C)
<b>Colourless Colring cable ties</b>						
0 320 30	0.5	18	8	75	-40	-10
0 320 31	0.5	20	8	75	-40	-10
0 320 32	0.5	38	8	75	-40	-10
0 320 37	0.5	20	13	75	-40	-10
0 320 38	0.5	38	13	75	-40	-10
0 320 39	0.5	38	13	75	-40	-10
0 320 40	0.5	38	13	75	-40	-10
0 320 42	0.5	38	22	75	-40	-10
0 320 43	0.5	38	22	75	-40	-10
0 320 44	0.5	38	22	75	-40	-10
0 320 47	1	38	53	75	-40	-10
0 320 49	1	38	53	75	-40	-10
0 320 50	1	38	53	75	-15	-10
0 320 52	0.45	20	8	75	-40	-10
0 320 54	0.6	20	13	75	-40	-10
0 320 55	0.9	38	22	75	-40	-10
0 320 57	0.9	38	22	75	-40	-10
0 320 58	1.5	38	53	75	-40	-10
0 320 61	0.5	38	8	75	-40	-10
0 320 63	0.5	38	22	75	-40	-10
0 320 45	2	38	53	75	-15	-10
0 320 46	2	38	77	75	-15	-10
0 320 48	2	38	77	75	-15	-10
0 320 51	2	38	111	75	-15	-10
0 320 12	0.5	18	8	105	-40	0
0 320 13	0.5	20	8	105	-40	0
0 320 14	0.5	38	8	105	-40	0
0 320 15	0.5	20	13	105	-40	0
0 320 18	0.5	38	13	105	-40	0
0 320 19	0.5	38	13	105	-40	0
0 320 20	0.5	38	13	105	-40	0
0 320 22	0.5	38	22	105	-40	0
0 320 23	0.5	38	22	105	-40	0
0 320 24	0.5	38	22	105	-40	0
0 320 29	1	38	53	105	-40	0
0 320 25	2	38	53	85	-15	0
0 320 26	2	38	77	85	-15	0
0 320 27	2	38	77	85	-15	0
0 320 28	2	38	111	85	-15	0
<b>Black Colring cable ties</b>						
0 318 20	1	8	8	85	-15	-10
0 318 21	1	8	8	85	-15	-10
0 318 22	1	8	8	85	-15	-10
0 318 23	1	13	8	85	-15	-10
0 318 24	1	13	13	85	-15	-10
0 318 25	1	13	13	85	-15	-10
0 318 26	1	13	13	85	-15	-10
0 318 27	1.5	22	22	85	-15	-10
0 318 28	1.5	22	22	85	-15	-10
0 318 29	1.5	22	22	85	-15	-10
0 318 33	1.5	22	22	85	-15	-10
0 318 30	2	53	53	85	-15	-10
0 318 34	2	53	53	85	-15	-10
0 318 31	2	53	53	85	-15	-10
0 318 35	2	53	53	85	-15	-10
0 318 32	2	53	53	85	-15	-10
0 318 36	2	77	77	85	-15	-10
0 318 37	2	77	77	85	-15	-10
0 318 38	2	111	111	85	-15	-10
0 318 00	1	8	8	105	-15	0
0 318 01	1	8	8	105	-15	0
0 318 02	1	8	8	105	-15	0
0 318 03	1	13	13	105	-15	0
0 318 04	1	13	13	105	-15	0
0 318 05	1	13	13	105	-15	0
0 318 06	1	13	13	105	-15	0
0 318 07	1.5	22	22	105	-15	0
0 318 08	1.5	22	22	105	-15	0
0 318 09	1.5	22	22	105	-15	0
0 318 13	1.5	22	22	105	-15	0
0 318 10	2	53	53	105	-15	0
0 318 14	2	53	53	105	-15	0
0 318 11	2	53	53	105	-15	0
0 318 15	2	53	53	105	-15	0
0 318 12	2	53	53	105	-15	0
0 318 16	2	77	77	105	-15	0
0 318 17	2	77	77	105	-15	0
0 318 18	2	111	111	105	-15	0

Cat.Nos	Ratchet force (daN)	Tensile strength according to EN 50146		Temperature resistance		
		Min tensile strength (daN)	Max. operating temperature (°C)	Min. operating temperature (°C)	Min. installation temperature (°C)	
<b>Colourless Colring cable ties</b>						
0 318 20	1	8	8	85	-15	-10
0 318 21	1	8	8	85	-15	-10
0 318 22	1	8	8	85	-15	-10
0 318 23	1	13	8	85	-15	-10
0 318 24	1	13	13	85	-15	-10
0 318 25	1	13	13	85	-15	-10
0 318 26	1	13	13	85	-15	-10
0 318 27	1.5	22	22	85	-15	-10
0 318 28	1.5	22	22	85	-15	-10
0 318 29	1.5	22	22	85	-15	-10
0 318 33	1.5	22	22	85	-15	-10
0 318 30	2	53	53	85	-15	-10
0 318 34	2	53	53	85	-15	-10
0 318 31	2	53	53	85	-15	-10
0 318 35	2	53	53	85	-15	-10
0 318 32	2	53	53	85	-15	-10
0 318 36	2	77	77	85	-15	-10
0 318 37	2	77	77	85	-15	-10
0 318 38	2	111	111	85	-15	-10
0 318 00	1	8	8	105	-15	0
0 318 01	1	8	8	105	-15	0
0 318 02	1	8	8	105	-15	0
0 318 03	1	13	13	105	-15	0
0 318 04	1	13	13	105	-15	0
0 318 05	1	13	13	105	-15	0
0 318 06	1	13	13	105	-15	0
0 318 07	1.5	22	22	105	-15	0
0 318 08	1.5	22	22	105	-15	0
0 318 09	1.5	22	22	105	-15	0
0 318 13	1.5	22	22	105	-15	0
0 318 10	2	53	53	105	-15	0
0 318 14	2	53	53	105	-15	0
0 318 11	2	53	53	105	-15	0
0 318 15	2	53	53	105	-15	0
0 318 12	2	53	53	105	-15	0
0 318 16	2	77	77	105	-15	0
0 318 17	2	77	77	105	-15	0
0 318 18	2	111	111	105	-15	0
<b>Black Colring cable ties</b>						

## External agents resistance

- Good resistance to bases, oils, greases, petroleum products, chlorinated solvents
- Humidity retention: 1.5 % ≤ humidity retention ≤ 3 %

## Fire resistance

- Flame resistance UL 94: V2
- Flame-retardant
- Needle flame test according to IEC 60695-11-5
- Oxygen index: EN ISO 4589-1 / ASTM D 2863-00: 28.5% (26% for Colring black)
- Halogen-free polyamide, class 1 acc. to ASTM D 4066 (Class 2 for Colring black)

## Dimensions

### Identification cable ties

Cat.No 0 320 61

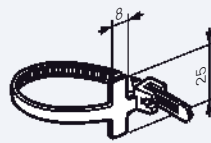

Cat.No 0 320 63

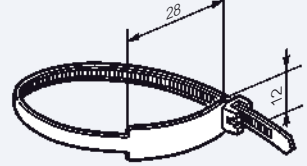

### Accessories

Cat.Nos 0 320 65/67

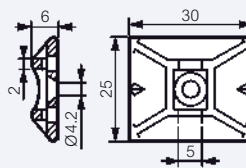

Cat.No 0 320 70

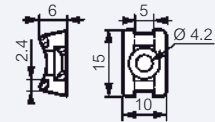

Cat.No 0 320 72

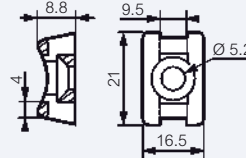

Cat.No 0 320 76

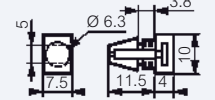

Cat.No 0 320 85

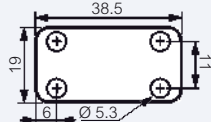

## Example of use



Duplex marker holders Cat.No 0 384 52 (p. 571), attached using 2 Colring cable ties Cat.No 0 320 31, equipped with labels



# VIKING™ 3

## Screw or automatic spring connection

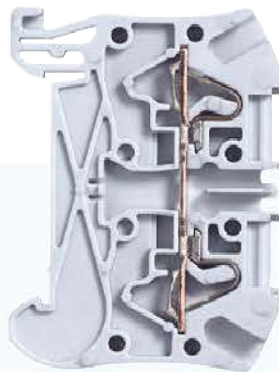

### SCREW CONNECTION

- High contact pressure
- Excellent mechanical strength
- Permissible cross-sections: 0.25 mm<sup>2</sup> to 70 mm<sup>2</sup> (flexible wire) and 0.25 mm<sup>2</sup> to 95 mm<sup>2</sup> (rigid wire)
- Identical height for blocks of 16 mm<sup>2</sup> to 70 mm<sup>2</sup>



Single end caps for pitches of 5 to 10.

### AUTOMATIC SPRING CONNECTION

- No tool required for connection
- Constant contact pressure
- Permissible cross-sections: 0.5 mm<sup>2</sup> to 16 mm<sup>2</sup> with or without ferrule
- Integrated end caps for pitches of 6 to 12

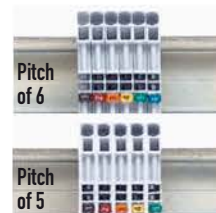

Optimized terminal block size. Identical electrical characteristics for blocks with a pitch of 5 and those with a pitch of 6.



**Addition of functions on module for equipping:** standard, neutral or protected isolation, mini-circuit-breaker, automotive-type fuse, etc.

International approvals: UL/CSA/NF/IMQ/BV  
ATEX certification









Conform to IEC EN 60947-7-1, IEC EN 60947-7-2 and IEC EN 60947-7-3

# Viking™ 3 terminal blocks with screw connection and accessories

for copper cables

				ELECTRICAL FUNCTION	
	<b>Connecting</b> (p. 280)	1 connection - 1 entry/1 outlet			
		1 connection - 2 entries/2 outlets			
		2 connections on 2 levels			
		3 connections on 3 levels			
	<b>For protection conductor</b> (p. 280)	1 connection - 1 entry/1 outlet - metal base			
		1 connection - 2 entries/2 outlets - metal base			
	<b>Disconnect</b> (p. 281)	1 connection	Open (to be equipped)		
			For fuse cartridge 5 x 20 with handle lever		
			For fuse cartridge 5 x 20 with handle lever + blown fuse indicator		
			For neutral circuit with handle lever		
			For standard circuit	With handle lever	
				With mini lever	
			For circuit not broken	With handle lever	
				With mini lever	
For fuse cartridge 5 x 20 with screwed plug					
	<b>Function blocks</b> (p. 281)	1 connection	Modular		
			Diode carrier 1N4007		
		2 connections on 2 levels	Diode carrier 1N4007		
			With voltage presence LED		
	<b>For sensor and actuator</b> (p. 281)	3 connections on 3 levels	Sensor		
			Actuator		
			Phase/Neutral/Earth		
<b>PNE</b> (p. 280)					
<b>Measurement</b> (p. 281)		1 connection	Disconnect for measuring circuit		

1: Blown fuse indicator 12/24/48 V ~ / ~. Cat.No 0 375 24 or 110/250 V ~. Cat.No 0 375 25 - 2: Or end stop Cat.No 0 375 10 - 3: Upper level only - 4: Lower level only - 5: Lower and intermediate levels

TERMINAL BLOCKS				INSULATION		EQUIPOTENTIAL LINK					PROTECTION		MEASURE- MENT	ASSOCIATED PRODUCTS
Nominal cross-section (mm <sup>2</sup> )	Pitch (mm)	Colour	Cat.Nos	End cap	Separation and insulation divider	Automatic insertion bridging comb			Comb for 12 blocks, side	Bar for 12 blocks, front	Single pole screen	Cut to length screen	Test socket	
						2 red blocks	10 red blocks	10 blue blocks						
2.5	5	0 371 60	0 375 50 <sup>(2)</sup>	0 375 60	0 375 02	0 375 01	0 375 00				0 375 65	0 375 68	0 375 27 <sup>(7)</sup>	
		0 371 00												
		0 371 20												
		0 371 30												
4	6	0 371 61	0 375 50 <sup>(2)</sup>	0 375 60	0 375 05	0 375 04	0 375 03				0 375 65	0 375 68	0 375 27 <sup>(7)</sup>	End stops (p. 284)
		0 371 01												
		0 371 21												
		0 371 31												
6	8	0 371 62	0 375 50 <sup>(2)</sup>	0 375 60	0 375 07 <sup>(6)</sup>	0 375 08 <sup>(6)</sup>					0 375 66	0 375 68	0 375 27	
		0 371 02												
		0 371 78												
10	10	0 371 63	0 375 50 <sup>(2)</sup>	0 375 60					0 375 40	0 375 66	0 375 68	0 375 75		
16	12	0 371 64	0 375 51	0 375 61						0 375 42	0 375 67	0 375 69	0 375 76	Label holder for end stop (p. 284)
		0 371 04												
35	15	0 371 65	0 375 51	0 375 61						0 375 44	0 375 67	0 375 69	0 375 76	
		0 371 05												
70	22	0 371 66	built-in											
4	6	0 371 69	0 375 52	0 375 62	0 375 05	0 375 04	0 375 03						0 375 27 <sup>(7)</sup>	
2.5	5	0 371 09	0 375 53	0 375 63	0 375 02	0 375 01	0 375 00						0 375 27 <sup>(3)(7)</sup>	
		0 371 67												
4	6	0 371 08	0 375 53	0 375 63	0 375 05	0 375 04	0 375 03						0 375 27 <sup>(3)(7)</sup>	
2.5	5	0 371 51	0 375 54	0 375 54	0 375 02 <sup>(3)</sup>	0 375 01 <sup>(3)</sup>	0 375 00 <sup>(3)</sup>	0 375 46 <sup>(5)</sup>	0 375 47 <sup>(5)</sup>				0 375 27 <sup>(3)(7)</sup>	
2.5	5	0 371 70	0 375 50 <sup>(2)</sup>											
4	6	0 371 71												
6	8	0 371 72												
10	10	0 371 73												
16	12	0 371 74												
35	15	0 371 75												
35	15	0 371 76												
4	6	0 371 79	0 375 52											
2.5	6	0 371 80	0 375 55	0 375 62	0 375 05	0 375 04	0 375 03						0 375 27 <sup>(7)</sup>	
		0 371 81												
		0 371 81 + 0 375 24/25 <sup>(1)</sup>												
		0 371 82												
		0 371 83												
		0 371 84												
10	12	0 371 85	0 375 55	0 375 62	0 375 05	0 375 04	0 375 03						0 375 27 <sup>(7)</sup>	
		0 371 86	0 375 55	0 375 62	0 375 05	0 375 04	0 375 03						0 375 27 <sup>(7)</sup>	
2.5	5	0 371 53	0 375 55		0 375 02	0 375 01	0 375 00						0 375 27 <sup>(7)</sup>	Shielding (p. 286)
4	6	0 371 54	0 375 53	0 375 63	0 375 05	0 375 04	0 375 03						0 375 27 <sup>(3)(7)</sup>	
4	6	0 371 55	0 375 53	0 375 63	0 375 05	0 375 04	0 375 03						0 375 27 <sup>(3)(7)</sup>	
		0 371 56	0 375 53	0 375 63	0 375 05 <sup>(4)</sup>	0 375 04 <sup>(4)</sup>	0 375 03 <sup>(4)</sup>							
2.5	5	0 371 51	0 375 54	0 375 54	0 375 02 <sup>(3)</sup>	0 375 01 <sup>(3)</sup>	0 375 00 <sup>(3)</sup>	0 375 46 <sup>(5)</sup>	0 375 47 <sup>(5)</sup>				0 375 27 <sup>(3)(7)</sup>	CAB 3 (p. 294)
		0 371 52												
4	8	0 371 92	0 375 57										0 375 77	

6: Cat.No 0 375 07 for 3 terminal blocks - 7: Permanent measurement: side by side installation of 2 test sockets not possible

# Viking™ 3 terminal blocks with spring connection and accessories

for copper cables

				ELECTRICAL FUNCTION	
	<b>Connecting</b> (p. 282)	1 connection - 2 wires - 1 entry/1 outlet			
		1 connection - 3 wires - 1 entry/2 outlets			
		1 connection - 4 wires - 2 entries/2 outlets			
		2 connections - 4 wires - 2 levels			
	<b>For protection conductor</b> (p. 282)	1 connection - 2 wires - 1 entry/1 outlet - metal base			
		1 connection - 3 wires - 1 entry/2 outlets - metal base			
		1 connection - 4 wires - 2 entries/2 outlets - metal base			
	<b>Disconnect</b> (p. 283)	1 connection 2 wires	Open (to be equipped)		
			For fuse cartridge 5 x 20 with handle lever		
			For fuse cartridge 5 x 20 with handle lever + blown fuse indicator		
			For neutral circuit with handle lever		
			For standard circuit	With handle lever With mini lever	
			For circuit not broken	With handle lever With mini lever	
	<b>Function blocks</b> (p. 283)	1 connection 4 wires 2 entries/2 outlets	Diode carrier 1N4007		
		2 connections 4 wires 2 levels	Diode carrier 1N4007		
			With voltage presence LED		

1: Blown fuse indicator 12/24/48V~/~ Cat.No 0 375 24 or 110/250V~/~ Cat.No 0 375 25 - 2: Lower level only - 3: Upper level only - 4: Current IEC 60947-7-1 : max. 24 A  
5: Cat.No 0 375 07 for 3 terminal blocks - 6: Permanent measurement: side by side installation of 2 test sockets not possible

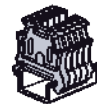

	TERMINAL BLOCKS				INSULATION		EQUIPOTENTIAL LINK			MEASUREMENT
	Nominal cross-section (mm <sup>2</sup> )	Pitch (mm)	Colour	Cat.Nos	End cap	Separation and insulation divider	Automatic insertion bridging comb			Test socket
							2 red blocks	10 red blocks	10 blue blocks	
	4	5	● 0 372 60	0 375 86	0 375 95	0 375 02 <sup>(4)</sup>	0 375 01 ● <sup>(4)</sup>	0 375 00 ● <sup>(4)</sup>	0 375 27 <sup>(6)</sup>	
			● 0 372 00							
			● 0 372 20							
	4	6	● 0 372 61	built-in	0 375 95	0 375 05	0 375 04 ●	0 375 03 ●	0 375 27 <sup>(6)</sup>	
			● 0 372 01							
			● 0 372 21							
	6	8	● 0 372 62	built-in		0 375 07/08 <sup>(5)</sup>			0 375 27	
			● 0 372 02							
	10	10	● 0 372 63	built-in		0 375 82				
			● 0 372 03							
	16	12	● 0 372 64	built-in		0 375 85				
			● 0 372 04							
	4	5	● 0 372 40	0 375 87	0 375 95	0 375 02 <sup>(4)</sup>	0 375 01 ● <sup>(4)</sup>	0 375 00 ● <sup>(4)</sup>	0 375 27 <sup>(6)</sup>	
			● 0 372 41							
			● 0 372 42							
	4	6	● 0 372 43	built-in	0 375 95	0 375 05	0 375 04 ●	0 375 03 ●	0 375 27 <sup>(6)</sup>	
			● 0 372 44							
	4	5	● 0 372 46	0 375 88	0 375 95	0 375 02 <sup>(4)</sup>	0 375 01 ● <sup>(4)</sup>	0 375 00 ● <sup>(4)</sup>	0 375 27 <sup>(6)</sup>	
			● 0 372 47							
	4	6	● 0 372 69	built-in		0 375 05	0 375 04 ●	0 375 03 ●	0 375 27 <sup>(6)</sup>	
			● 0 372 09							
	4	5	● 0 372 67	0 375 89	0 375 96	0 375 02 <sup>(4)</sup>	0 375 01 ● <sup>(4)</sup>	0 375 00 ● <sup>(4)</sup>	0 375 27 <sup>(3)(6)</sup>	
			● 0 372 07							
	4	6	● 0 372 68	built-in	0 375 96	0 375 05	0 375 04 ●	0 375 03 ●	0 375 27 <sup>(3)(6)</sup>	
			● 0 372 08							
	4	5	● 0 372 70	0 375 86						
			● 0 372 71							
			● 0 372 72							
			● 0 372 73							
			● 0 372 74							
	4	5	● 0 372 10	0 375 87						
			● 0 372 11							
			● 0 372 12							
			● 0 372 79							
	2.5	6	● 0 372 80	0 375 90		0 375 05	0 375 04 ●	0 375 03 ●	0 375 27 <sup>(6)</sup>	
			● 0 372 81							
			● 0 372 81 + 0 375 24/25 <sup>(1)</sup>							
			● 0 372 82							
			● 0 372 83							
			● 0 372 84							
			● 0 372 85							
● 0 372 86										
	4	5	● 0 372 54	0 375 88	0 375 95					
			● 0 372 55							
			● 0 372 56							

**ASSOCIATED PRODUCTS**

End stops (p. 284)



Label holder for end stop (p. 284)



Handle lever mini lever (p. 285)



Joining rods for disconnect blocks (p. 285)

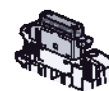

Blown fuse indicators (p. 285)



Shielding (p. 286)



CAB 3 (p. 294)

# Viking™ 3 terminal blocks with screw connection

for copper cables



TN-C-S earthing schema  
PEN separation  
0 371 98 + 0 371 04 + 0 375 42



0 371 61 + 0 371 01 + 0 371 21 + 0 371 31 + 0 371 77



0 371 69



0 371 68



0 371 70 on rail



0 371 74



0 371 76



Same profile up to 10 mm pitch and same height from 12 to 22 mm pitch

Technical characteristics **p. 287** dimensions **see e-catalogue**  
Approvals **p. 826**

Used to make the electrical connection between 2 flexible copper wires with or without ferrules or 2 rigid copper wires  
2 areas for automatic insertion bridging combs up to 8 pitch (upper level only for multi-level blocks)  
For rails depth 15 mm, EN 60715 depth 7.5 mm and 15 mm

Pack	Cat.Nos	Connecting				
		Grey for standard circuit, blue for neutral conductor, orange for circuit not broken by the master isolating device, red for special circuits (safety, protected, etc), green for protection conductor class II equivalent assemblies				
		<b>1 connection - 1 entry/1 outlet</b>				
			Nominal cross-section (mm <sup>2</sup> )	Rigid wire (mm <sup>2</sup> )	Capacity Flexible wire (mm <sup>2</sup> ) with or without ferrules	Pitch (mm)
60	0 371 60	Colour Grey	2.5	0.25 to 4	0.25 to 2.5	5
60	0 371 00	Blue				
60	0 371 20	Orange				
60	0 371 30	Red				
50	0 371 61	Grey	4	0.25 to 6	0.25 to 4	6
50	0 371 01	Blue				
50	0 371 21	Orange				
50	0 371 31	Red				
50	0 371 77	Green				
40	0 371 62	Grey	6	0.5 to 10	0.25 to 6	8
40	0 371 02	Blue				
40	0 371 78	Green				
30	0 371 63	Grey	10	1.5 to 16	2.5 to 10	10
30	0 371 03	Blue				
20	0 371 64	Grey	16	1.5 to 25	4 to 16	12
20	0 371 04	Blue				
20	0 371 98	Green				
20	0 371 65	Grey				
20	0 371 05	Blue	35	2.5 to 50	4 to 35	15
20	0 371 99	Green				
20	0 371 05	Blue				
10	0 371 66 <sup>1</sup>	Grey	70	25 to 95	16 to 70	22
		<b>1 connection - 2 entries/2 outlets</b>				
25	0 371 69	Grey	4	0.25 to 6	0.25 to 4	6
25	0 371 09	Blue				
		<b>2 connections on 2 levels</b>				
60	0 371 67	Grey	2.5	0.25 to 4	0.25 to 2.5	5
60	0 371 07	Blue				
60	0 371 68	Grey	4	0.25 to 6	0.25 to 4	6
60	0 371 08	Blue				
		<b>3 connections on 3 levels</b>				
50	0 371 51 <sup>2</sup>	Grey	2.5	0.25 to 4	0.25 to 2.5	5

Pack	Cat.Nos	For protection conductor				
		Metal base				
		<b>1 connection - 1 entry/1 outlet</b>				
		Screwless fixing on rail up to 10 mm pitch and with screws for pitch 12 and 15 mm PEN from 10 mm <sup>2</sup>				
			Nominal cross-section (mm <sup>2</sup> )	Rigid wire (mm <sup>2</sup> )	Capacity Flexible wire (mm <sup>2</sup> ) with or without ferrules	Pitch (mm)
60	0 371 70	Colour Green/yellow	2.5	0.25 to 4	0.25 to 2.5	5
50	0 371 71	Green/yellow				
40	0 371 72	Green/yellow	6	0.5 to 10	0.25 to 6	8
30	0 371 73	Green/yellow				
10	0 371 74	Green/yellow	16	1.5 to 25	4 to 16	12
10	0 371 75	Green/yellow				
		<b>1 connection - bare block</b>				
10	0 371 76	-	35	2.5 to 50	4 to 35	15
		<b>1 connection - 2 entries/2 outlets</b>				
		Screwless fixing on rail				
50	0 371 79	Green/yellow	4	0.25 to 6	0.25 to 4	6
		<b>PNE - Phase/Neutral/Earth</b>				
		<b>3 connections on 3 levels</b>				
		Metal base				
		Green/yellow marking for the lower level				
		Screwless fixing on rail				
			Nominal cross-section (mm <sup>2</sup> )	Rigid wire (mm <sup>2</sup> )	Capacity Flexible wire (mm <sup>2</sup> ) with or without ferrules	Pitch (mm)
50	0 371 52 <sup>2</sup>	Colour Grey	2.5	0.25 to 4	0.25 to 2.5	5

1: Built-in end cap  
2: Rigid wire capacity: 2.5 mm<sup>2</sup> max. with equipotential bridging comb

Viking 3 power terminal blocks  
**p. 290**

CAB 3 marking system  
**p. 294**

# Viking™ 3 terminal blocks with screw connection

for copper cables (continued)

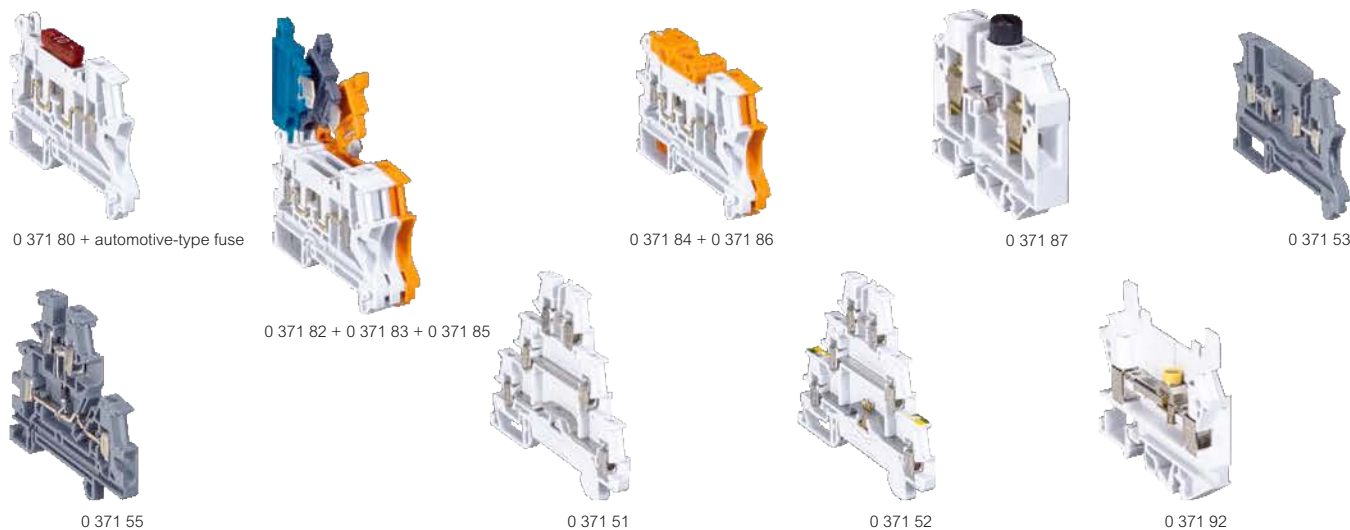

Technical characteristics **p. 287** dimensions **see e-catalogue**  
 Approvals **p. 826**

Used to make the electrical connection between 2 flexible copper wires with or without ferrules or 2 rigid copper wires  
 2 areas for automatic insertion bridging combs up to 8 pitch (upper level only for multi-level blocks)  
 For rails depth 15 mm, EN 60715 depth 7.5 mm and 15 mm

Pack	Cat.Nos	Disconnect terminal blocks 1 connection				
		Opening by means of blade type lever, handle lever or mini lever (with tool)				
		<b>Open (to be equipped)</b>				
		Can take blade type levers Cat.Nos 0 375 15/16/17/18 or in ELV installations a blade-type automotive fuse or a miniature circuit-breaker				
		Colour	Nominal cross-section (mm <sup>2</sup> )	Rigid wire (mm <sup>2</sup> )	Capacity Flexible wire (mm <sup>2</sup> ) with or without ferrules	Pitch (mm)
20	0 371 80	Grey	2.5	0.25 to 2.5	0.25 to 2.5	6
20	0 371 81	Grey	2.5	0.25 to 2.5	0.25 to 2.5	6
20	0 371 82	Grey/blue	2.5	0.25 to 2.5	0.25 to 2.5	6
20	0 371 83	Grey	2.5	0.25 to 2.5	0.25 to 2.5	6
20	0 371 84	Grey	2.5	0.25 to 2.5	0.25 to 2.5	6
20	0 371 85	Orange	2.5	0.25 to 2.5	0.25 to 2.5	6
20	0 371 86	Orange	2.5	0.25 to 2.5	0.25 to 2.5	6
20	0 371 87	Grey	10	0.25 to 10	0.25 to 10	12

Pack	Cat.Nos	Function blocks				
		<b>1 connection - modular</b>				
		Component connected with screws				
		Colour	Nominal cross-section (mm <sup>2</sup> )	Rigid wire (mm <sup>2</sup> )	Capacity Flexible wire (mm <sup>2</sup> ) with or without ferrules	Pitch (mm)
20	0 371 53	Grey	2.5	0.25 to 4	0.25 to 2.5	5
20	0 371 54	Grey	2.5	0.25 to 4	0.25 to 2.5	5
60	0 371 55	Grey	4	0.25 to 6	0.25 to 4	6
60	0 371 56	Grey	4	0.25 to 6	0.25 to 4	6

Pack	Cat.Nos	For sensors and actuators				
		For connecting sensors (Cat.No 0 371 51) or actuators (Cat.No 0 371 52), and their shared power supply unit using equipotential bridging comb Cat.Nos 0 375 46/47				
		<b>3 connections on 3 levels - for sensor</b>				
		Colour	Nominal cross-section (mm <sup>2</sup> )	Rigid wire (mm <sup>2</sup> )	Capacity Flexible wire (mm <sup>2</sup> ) with or without ferrules	Pitch (mm)
50	0 371 51 <sup>1</sup>	Grey	2.5	0.25 to 4	0.25 to 2.5	5
		<b>3 connections on 3 levels - for actuator</b>				
		Green/yellow marking for the lower level Metal base. Screwless fixing on rail				
50	0 371 52 <sup>1</sup>	Grey	2.5	0.25 to 4	0.25 to 2.5	5
		<b>Disconnect for measurement</b>				
		<b>1 connection</b>				
		With its accessories, allows intervention (measurements, maintenance, etc) on a current, voltage and power measuring circuit by keeping the current transformer secondary circuit closed				
		Colour	Nominal cross-section (mm <sup>2</sup> )	Rigid wire (mm <sup>2</sup> )	Capacity Flexible wire (mm <sup>2</sup> ) with or without ferrules	Pitch (mm)
25	0 371 92	Grey	4	0.25 to 4	0.25 to 4	8

<sup>1</sup>: Rigid wire capacity: 2.5 mm<sup>2</sup> max with equipotential bridging comb

For detailed dimensions, see e-catalogue



Blade type levers, joining rods and blown fuse indicators **p. 285**  
 Accessories **p. 284**

# Viking™ 3 terminal blocks with spring connection

for copper cables



0 372 60 + 0 372 00 + 0 372 20

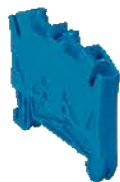

0 372 01



0 372 21



0 372 63



0 372 40



0 372 67



Automatic insertion of flexible wire with ferrule cap or rigid wire up to pitch of 6 mm



0 372 70 Automatic fixing on rail



0 372 72

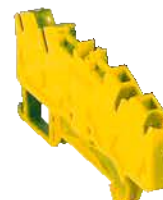

0 372 79

Technical characteristics p. 288 dimensions see e-catalogue Approvals p. 826

Screwless connection system, stainless steel spring type  
Used to make the electrical connection between 2 rigid copper wires, or flexible copper wires with or without ferrules (p. 292)  
Direct tool-free insertion of a rigid wire or flexible wire with ferrule, up to 6 mm pitch  
2 areas for automatic insertion bridging combs (upper level only for 2-level blocks)  
For rails depth 15 mm, EN 60715 depth 7.5 mm and 15 mm

Pack	Cat.Nos	Connecting					
		Grey for standard circuit, blue for neutral conductor, orange for circuit not broken by the master isolating device					
		<b>1 connection - 2 wires - 1 entry/1 outlet</b>					
			Nominal cross-section (mm <sup>2</sup> )	Rigid wire (mm <sup>2</sup> )	Capacity Flexible wire (mm <sup>2</sup> )	Capacity Flexible wire with ferrule (mm <sup>2</sup> )	Pitch (mm)
60	0 372 60	Grey	4	0.5 to 6	0.5 to 4	0.5 to 2.5	5
60	0 372 00	Blue					
60	0 372 20	Orange					
50	0 372 61 <sup>1</sup>	Grey	4	0.5 to 6	0.5 to 4	0.5 to 4	6
50	0 372 01 <sup>1</sup>	Blue					
50	0 372 21 <sup>1</sup>	Orange					
50	0 372 62 <sup>1</sup>	Grey	6	0.5 to 6	0.5 to 6	0.5 to 6	8
50	0 372 02 <sup>1</sup>	Blue					
40	0 372 63 <sup>1</sup>	Grey	10	0.75 to 10	0.75 to 10	0.75 to 10	10
40	0 372 03 <sup>1</sup>	Blue					
10	0 372 64 <sup>1</sup>	Grey	16	4 to 16	4 to 16	4 to 16	12
10	0 372 04 <sup>1</sup>	Blue					
		<b>1 connection - 3 wires - 1 entry/2 outlets</b>					
60	0 372 40	Grey	4	0.5 to 6	0.5 to 4	0.5 to 2.5	5
60	0 372 41	Blue					
60	0 372 42	Orange					
50	0 372 43 <sup>1</sup>	Grey	4	0.5 to 6	0.5 to 4	0.5 to 4	6
50	0 372 44 <sup>1</sup>	Blue					
		<b>1 connection - 4 wires - 2 entries/2 outlets</b>					
60	0 372 46	Grey	4	0.5 to 6	0.5 to 4	0.5 to 2.5	5
60	0 372 47	Blue					
50	0 372 69 <sup>1</sup>	Grey	4	0.5 to 6	0.5 to 4	0.5 to 4	6
50	0 372 09 <sup>1</sup>	Blue					
		<b>2 connections - 4 wires - 2 levels</b>					
60	0 372 67	Grey	4	0.5 to 6	0.5 to 4	0.5 to 2.5	5
60	0 372 07	Blue					
50	0 372 68 <sup>1</sup>	Grey	4	0.5 to 6	0.5 to 4	0.5 to 4	6
50	0 372 08 <sup>1</sup>	Blue					

Pack	Cat.Nos	For protection conductor					
		Metal base Screwless fixing on rail PEN from 10 mm <sup>2</sup>					
		<b>1 connection - 2 wires - 1 entry/1 outlet</b>					
			Nominal cross-section (mm <sup>2</sup> )	Rigid wire (mm <sup>2</sup> )	Capacity Flexible wire (mm <sup>2</sup> )	Capacity Flexible wire with ferrule (mm <sup>2</sup> )	Pitch (mm)
60	0 372 70	Green/yellow	4	0.5 to 6	0.5 to 4	0.5 to 2.5	5
50	0 372 71 <sup>1</sup>	Green/yellow					
25	0 372 72 <sup>1</sup>	Green/yellow	6	0.5 to 6	0.5 to 6	0.5 to 6	8
20	0 372 73 <sup>1</sup>	Green/yellow					
15	0 372 74 <sup>1</sup>	Green/yellow	10	0.75 to 10	0.75 to 10	0.75 to 10	10
15	0 372 74 <sup>1</sup>	Green/yellow					
16	0 372 74 <sup>1</sup>	Green/yellow	16	4 to 16	4 to 16	4 to 16	12
16	0 372 74 <sup>1</sup>	Green/yellow					
		<b>1 connection - 3 wires - 1 entry/2 outlets</b>					
40	0 372 10	Green/yellow	4	0.5 to 6	0.5 to 4	0.5 to 2.5	5
30	0 372 11 <sup>1</sup>	Green/yellow					
		<b>1 connection - 4 wires - 2 entries/2 outlets</b>					
40	0 372 12	Green/yellow	4	0.5 to 6	0.5 to 4	0.5 to 2.5	5
30	0 372 79 <sup>1</sup>	Green/yellow					

1: Built-in end cap

Starfix ferrules and crimping tools p. 292

CAB 3 marking system p. 294

# Viking™ 3 terminal blocks with spring connection

for copper cables (continued)

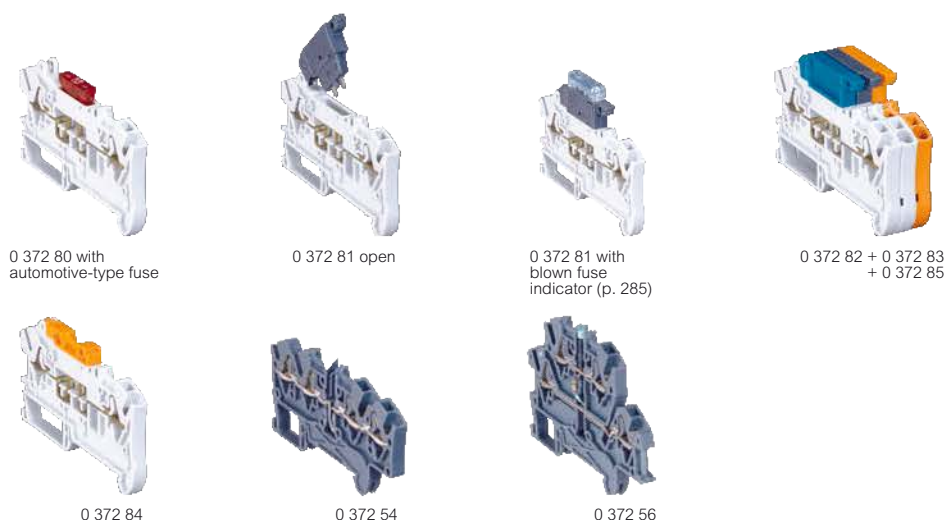

Technical characteristics **p. 288** dimensions **see e-catalogue**  
Approvals **p. 826**

Screwless connection system, stainless steel spring type  
Used to make the electrical connection between 2 copper wires, or flexible copper wires with or without ferrules (p. 292)  
Direct tool-free insertion of a rigid wire or flexible wire with ferrule, up to 6 mm pitch  
2 areas for automatic insertion bridging combs (upper level only for 2-level blocks)  
For rails depth 15 mm, EN 60715 depth 7.5 mm and 15 mm

Pack	Cat.Nos	Disconnect terminal blocks 1 connection - 2 wires					
		Opening by means of blade type lever, handle lever or mini lever (with tool)					
		<b>Open (to be equipped)</b>					
		Can take blade type levers Cat.Nos 0 375 15/16/17/18 or in ELV installations a blade-type automotive fuse or a miniature circuit-breaker					
			Capacity				
			Nominal cross-section (mm <sup>2</sup> )	Rigid wire (mm <sup>2</sup> )	Flexible wire (mm <sup>2</sup> )	Flexible wire with ferrule (mm <sup>2</sup> )	
		Colour				Pitch (mm)	
20	0 372 80	Grey	2.5	0.5 to 2.5	0.5 to 2.5	0.5 to 2.5	6
20	0 372 81	Grey	2.5	0.5 to 2.5	0.5 to 2.5	0.5 to 2.5	6
20	0 372 82	Grey/blue	2.5	0.5 to 2.5	0.5 to 2.5	0.5 to 2.5	6
20	0 372 83	Grey	2.5	0.5 to 2.5	0.5 to 2.5	0.5 to 2.5	6
20	0 372 84	Grey	2.5	0.5 to 2.5	0.5 to 2.5	0.5 to 2.5	6
20	0 372 85	Orange	2.5	0.5 to 2.5	0.5 to 2.5	0.5 to 2.5	6
20	0 372 86	Orange	2.5	0.5 to 2.5	0.5 to 2.5	0.5 to 2.5	6

Pack	Cat.Nos	Function blocks					
		<b>1 connection - 4 wires - 2 entries/2 outlets - diode carrier</b>					
			Capacity				
			Nominal cross-section (mm <sup>2</sup> )	Rigid wire (mm <sup>2</sup> )	Flexible wire (mm <sup>2</sup> )	Flexible wire with ferrule (mm <sup>2</sup> )	
		Colour				Pitch (mm)	
60	0 372 54	Grey	4	0.5 to 6	0.5 to 4	0.5 to 2.5	5
60	0 372 55	Grey	4	0.5 to 6	0.5 to 4	0.5 to 2.5	5
60	0 372 56	Grey	4	0.5 to 6	0.5 to 4	0.5 to 2.5	5

Blade type levers, joining rods and blown fuse indicators **p. 285**

Accessories **p. 284 to 286**

Starfix ferrules and crimping tools **p. 292**



For detailed dimensions, **see e-catalogue**



# Viking™ 3 accessories for terminal blocks

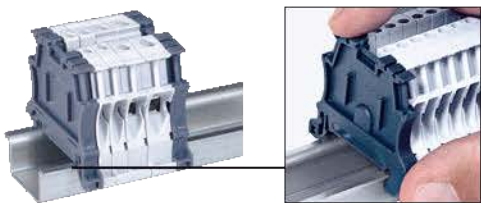

End stop 0 375 10, screwless mounting



0 375 11 with label holder 0 395 96



0 375 12 with CAB 3 labelling



0 375 13 with label holder Duplix 0 384 98

## Technical characteristics p. 289

Pack	Cat.Nos	Rails for cutting to length
10	0 374 04	Length 2 m ┌ EN 60715 depth 7.5 mm
10	0 374 07	┌ depth 15 mm
10	0 477 22	┌ depth 7.5 mm with oblong holes
10	0 477 23	┌ depth 15 mm with oblong holes
10	0 394 49	<b>45° mounting bracket</b> Set of 2 supports for 45° rail slope Supplied with 4 M6 screws, nuts and washers
20	0 364 66	<b>Adaptor</b> For mounting on rail ┌ equipment fitting on rail ┌ Width 17 mm Increase equipment height for 6 mm
50	0 375 10	<b>End stops</b> Accept CAB 3 markers <b>Automatic 6 mm pitch</b> Screwless mounting For rails ┌ depth 15 mm and ┌ EN 60715 depth 7.5 mm and 15 mm Accepts label holder Cat.No 0 395 96 Acts as end cap for screw terminal blocks 1 entry/1 outlet 5, 6, 8 and 10 mm pitch
20	0 375 11	<b>8 mm pitch</b> For rails ┌ depth 15 mm and ┌ EN 60715 depth 7.5 mm and 15 mm Accepts label holder Cat.No 0 395 96
10	0 375 12	<b>10 mm pitch</b> For rails ┌ depth 15 mm and ┌ EN 60715 depth 7.5 mm (except for rail fixed on plate) and 15 mm For supporting protection or shielding bar: - Brass bar Cat.Nos 0 373 00/01 (p. 209) - Copper bar 12 x 4 mm with clamps Cat.No 0 373 02 (p. 209) - IP 2X terminal block with flat steel bar 12 x 2 mm Cat.No 0 048 19 (p. 180) - Copper bar 12 x 4 mm Cat.No 0 373 49 or 0 373 89 (p. 209) - Shielding bar 10 x 3 mm Cat.No 0 375 34 (p. 286)
20	0 375 13	<b>12 mm pitch</b> For rails ┌ EN 60715, ┌ depth 15 mm and ┌ EN 60715 depth 7.5 mm and 15 mm After cutting out the upper divider, can be labelled using Duplix label holder Cat.No 0 384 98

Pack	Cat.Nos	Identification accessories
20	0 395 96	Transparent label holder with variable angle Fixing on end stops Cat.Nos 0 375 10/11 Supplied with label 32 x 9.5 mm Can take label Cat.No 0 395 97
20	0 395 97	Label for engraving 28 x 9.5 mm For label holder Cat. No 0 395 96. Flexible ABS White background, black engraving
10	0 395 98	Black felt tip pen for permanent marking
		<b>End caps</b> Grey
		<b>For screw terminal blocks</b>
100	0 375 50	1 entry/1 outlet 5, 6, 8 and 10 mm pitch
20	0 375 51	1 entry/1 outlet 12 and 15 mm pitch
20	0 375 52	2 entries/2 outlets
20	0 375 53	2 levels
20	0 375 54	3 levels
20	0 375 55	Disconnect type 6 mm pitch and function blocks 5 mm pitch
20	0 375 56	Disconnect type fuse cartridge 5 x 20 with screwed plug
10	0 375 57	Disconnect for measurement
		<b>For spring terminal blocks with 5 mm pitch</b> Allows the block to become 6 mm pitch and take a flexible wire fitted with a 4 mm <sup>2</sup> ferrule (p. 292)
50	0 375 86	1 entry/1 outlet
50	0 375 87	1 entry/2 outlets
20	0 375 88	2 entries/2 outlets
20	0 375 89	2 levels
20	0 375 90	<b>For spring terminal blocks with 6 mm pitch</b> Disconnect type

# Viking™ 3 accessories for terminal blocks (continued)

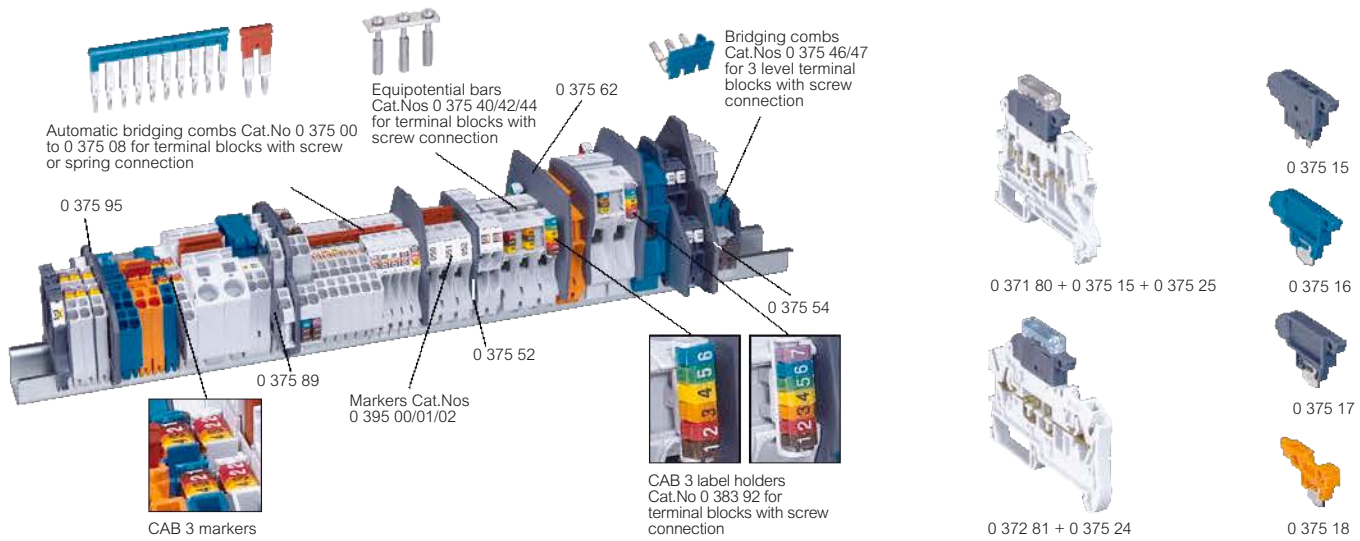

Technical characteristics p. 289

## Pack Cat.Nos Separation and insulation dividers

Pack	Cat.Nos	Description	Image
		Grey	
20	0 375 60	<b>For screw terminal blocks</b> 1 entry/1 outlet 5, 6, 8 and 10 mm pitch	
10	0 375 61	1 entry/1 outlet 12 and 15 mm pitch	
10	0 375 62	2 entries/2 outlets and disconnect type 6 mm pitch	
10	0 375 63	2 levels	
20	0 375 54	3 levels	
10	0 375 95	<b>For spring terminal blocks</b> 1 entry/1 outlet, 1 entry/2 outlets and 2 entries/2 outlets 5 and 6 mm pitch	
10	0 375 96	2 levels	

## Equipotential bridging accessories

Pack	Cat.Nos	Description	Image
		<b>Bridging combs for screw and spring terminal blocks</b> Front mounting (automatic insertion), screwless Isolated and separable Consecutive or alternating connection	
20	0 375 00 <sup>1</sup>	For 10 blocks with 5 mm pitch - blue	
20	0 375 01 <sup>1</sup>	For 10 blocks with 5 mm pitch - red	
50	0 375 02 <sup>1</sup>	For 2 blocks with 5 mm pitch - red	
20	0 375 03 <sup>2</sup>	For 10 blocks with 6 mm pitch - blue	
20	0 375 04 <sup>2</sup>	For 10 blocks with 6 mm pitch - red	
50	0 375 05 <sup>2</sup>	For 2 blocks with 6 mm pitch - red	
20	0 375 07 <sup>3</sup>	For 3 blocks with 8 mm pitch - red	
20	0 375 08 <sup>3</sup>	For 2 blocks with 8 mm pitch - red	
		<b>Bars for screw terminal blocks</b> Front mounting with screws Pre-assembled, not insulated bar Consecutive or alternating connection	
10	0 375 40	For 12 blocks with 10 mm pitch	
10	0 375 42 <sup>4</sup>	For 12 blocks with 12 mm pitch	
10	0 375 44	For 12 blocks with 15 mm pitch	
		<b>Bridging combs for 3-level screw terminal blocks</b> For lower and intermediate levels of blocks Cat.Nos 0 371 51/52 Side mounting Insulated and separable	
10	0 375 46	For 12 blocks with 5 mm pitch - brown	
10	0 375 47	For 12 blocks with 5 mm pitch - blue	
		<b>Bridging combs for spring terminal blocks</b> Front mounting (automatic insertion), screwless Isolated Red	
20	0 375 82	For 2 blocks with 10 mm pitch	
20	0 375 85	For 2 blocks with 12 mm pitch	

## Pack Cat.Nos Accessories for disconnect blocks

Pack	Cat.Nos	Description	Image
		For screw and spring terminal blocks	
		<b>Blade type levers</b> For open blocks Cat. Nos 0 371 80 and 0 372 80 Manual disconnection for handle type, tool required for mini lever type	
50	0 375 15	With handle lever for fuse cartridge 5 x 20	
50	0 375 16	Blue handle lever for neutral	
50	0 375 17	Grey handle lever	
50	0 375 18	Mini lever	
		<b>Joining rods</b> For handle and mini lever	
20	0 375 21	For 2 blocks	
20	0 375 22	For 3 blocks	
		<b>Blown fuse indicators</b> Clip directly onto blocks Cat.Nos 0 371 81, 0 372 81 or handle lever 0 375 15 (with power off)	
50	0 375 24	12/24/48 V <sub>~</sub> and ~ for block with fuse cartridge 5 x 20 with handle lever	
50	0 375 25	110/250 V <sub>~</sub> for block with fuse cartridge 5 x 20 with handle lever	

1: Cat. No 0 371 51/52: upper level only  
Cat. No 0 372 56: lower level only  
Cat. No 0 372 54: non shuntable  
2: Cat. No 0 371 56: lower level only  
3: Except for Cat.No 0 371 92  
4: Except for Cat.No 0 371 87

## Viking™ 3 accessories for terminal blocks (continued)

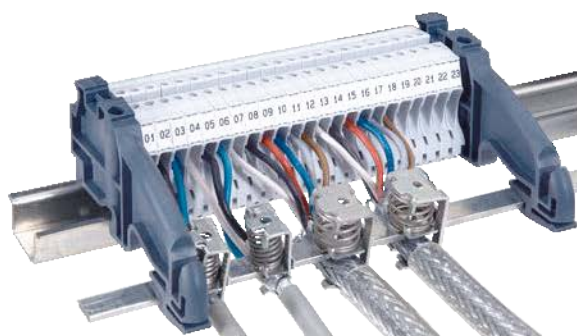

Shielding terminal block with end stops 0 375 12, bar 0 375 34 and clamps 0 375 30/31



0 375 76 + 0 371 64



0 375 77 + 0 371 92 open



0 375 66 + 0 371 63 + 0 371 03

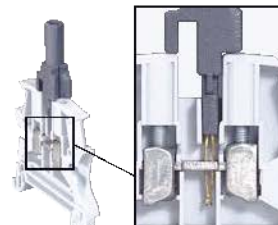

0 375 27 + 0 371 61

Pack	Cat. Nos	Shielding accessories
		Ensure safe, simple connection of cable shielding
		<b>Shielding clamps</b>
		For screw and spring terminal blocks
		- mounted by pivoting on collector bar
		10 x 3 mm Cat.No 0 375 34
		- mounted on plate with M4 screws (supplied)
		- mounted on rail  with Cat.No 0 364 69
10	0 375 30	For cable Ø 3 to 8 mm
10	0 375 31	For cable Ø 4 to 13.5 mm
4	0 375 32	For cable Ø 10 to 20 mm
		<b>Shielding bar</b>
		For screw and spring terminal blocks
		Steel
		Length 1 m
		For use with end stops Cat.No 0 375 12
10	0 375 34	10 x 3 mm
		<b>Screening continuity bracket</b>
50	0 375 35	For screw terminal blocks 1 entry/1 outlet
		5, 6, 8 and 10 mm pitch
		Connected with 2.8 x 0.8 mm clips
		or welded on
		Capacity: 1 mm <sup>2</sup>



Pack	Cat. Nos	Protective screens
		<b>1 pole</b>
		For screw terminal blocks 1 entry/1 outlet
10	0 375 65	5 and 6 mm pitch
10	0 375 66	8 and 10 mm pitch
10	0 375 67	12 and 15 mm pitch
		<b>Cut to length</b>
		Length 1 m
		Mounted on separation and insulation divider
		For screw terminal blocks 1 entry/1 outlet
		Can be equipped with CAB 3 marking system for terminal blocks (p. 294)
10	0 375 68	5, 6, 8 and 10 mm pitch
10	0 375 69	(divider Cat.No 0 375 60)
		12 and 15 mm pitch
		(divider Cat.No 0 375 61)
		<b>Measurement accessories</b>
		<b>For screw and spring terminal blocks</b>
10	0 375 27 <sup>1</sup>	Measurement socket for Ø4 mm plug for blocks with 5, 6 and 8 mm pitch
50	0 375 75	Measurement socket for Ø2 mm plug for blocks with 10 mm pitch Cat.Nos 0 371 03/63
20	0 375 76	Measurement socket for Ø4 mm plug for blocks with 12 and 15 mm pitch
10	0 375 77	Measurement socket for Ø4 mm plug for disconnect block for measurement Cat.No 0 371 92
10	0 394 45	<b>IP 2X safety tip adaptor</b>
		Ø2 mm test plug - Retractable tube
		For performing ad-hoc tests in accordance with regulations on the protection of workers
		Fixes directly on the Ø4 mm plug



1: Except for disconnect blocks with handle lever, screw terminal block with LED and spring function blocks. 2 and 3-level terminal blocks: upper level only. Side by side installation of 2 measurement sockets is possible only with 8 mm pitch blocks



# Viking™ 3 terminal blocks with screw connection

## Characteristics and dimensions (mm)

V2 polyamide according to UL 94, 960 °C according to IEC EN 60695-2-11  
Insulating material for terminal blocks: polyamide - 30° C to + 100° C

### Connecting blocks

Cat.Nos	Voltage (V)			Current (A)			Nominal cross-section			
	IEC	CSA	UL	le	IEC	CSA	UL	IEC (mm²)	CSA (AWG)	UL (AWG)
0 371 00/20/30/60	800	600	600	27	24	20	20	2.5	12	12
0 371 01/21/31/61				36	32	30	30	4	10	10
0 371 02/62				48	41	46	46	6	8	8
0 371 03/63				63	57	60	60	10	6	6
0 371 04/64/98				85	76	85	85	16	4	4
0 371 05/65/99				138	125	115	115	35	2	2
0 371 07/67	500	300	300	27	24	20	20	2.5	12	12
0 371 08/68				36	32	30	30	4	10	10
371 09/69				36	32	30	30	4	10	10
0 371 66				1000	600	600	213	192	200	200
0 371 77	800	600	600	36	32	30	30	4	10	10
0 371 78				48	41	46	46	6	8	8

Cat.No 0 371 51: see blocks for sensors  
IEC 60947-7-1, CSA no. 22-2 no. 158, UL 1059  
le: Rated current NF C 15100 table 52H, column 4

### Approved by ATEX:

LCIE 07 ATEX 0010 II 1 or 2 G or D Ex e/II tD/II D

The terminal blocks with screw connection covered by this certificate are 1-, 2- and 3-level connecting terminal blocks, and blocks for protection conductor with metal base<sup>(1)</sup> (detailed list on p. 826)  
The main characteristics are:

Operating temperature: - 30 °C to + 55 °C  
Maximum temperature of materials: + 85 °C

Working voltage acc. to EN 60079-7: 1-level terminal blocks: 500 V  
Blocks with 2 entries - 2 outlets: 250 V  
2 and 3-level terminal blocks: 250 V

Rated current:

Conductor cross-section (mm²)	2.5	4	6	10	16	35	70
Rated current (A)	18	23	30	42	57	93	145

Attestation of conformity of component for the customer is available on request

1: Except for Cat.No 0 371 76

### Blocks for protection conductor

Cat.Nos	Voltage (V)			Current (A)			Nominal cross-section		
	IEC	CSA	UL	le	IEC	IEC (mm²)	CSA (AWG)	UL (AWG)	
0 371 70	800	600	600	-	-	2.5	12	12	
0 371 71				-	-	4	10	10	
0 371 72				-	-	6	8	8	
0 371 73 <sup>(1)</sup>				63	57	10	6	6	
0 371 74 <sup>(1)</sup>				85	76	16	4	4	
0 371 75 <sup>(1)</sup>				138	125	35	2	2	
0 371 76	-	-	-	-	-	35	-	-	
0 371 79	500	300	300	-	-	4	10	10	

IEC 60947-7-2, CSA no. 22-2 no. 158, UL 1059  
le: Rated current NF C 15100 table 52H, column 4  
1: PEN terminal blocks

### Disconnect terminal blocks

Cat.Nos	Voltage (V)			Current (A)			Nominal cross-section		
	IEC	CSA	UL	IEC	CSA	UL	IEC (mm²)	CSA (AWG)	UL (AWG)
0 371 80	500	300	300	15	15	15	2.5	12	12
0 371 81 or 0 371 80 + 0 375 15	250	250	250	6.3	6.3	6.3			
0 371 82	500	300	300	15	15	15			
0 371 83									
0 371 84									
0 371 85									
0 371 86	250	250	250	10	10	10	10	6	6
0 371 87									

IEC 60947-7-1/7-3, CSA no. 22-2 no. 158, UL 1059

Power according to IEC 60947-7-3

Cat.Nos	Short-circuit		Short-circuit + overload	
	Separate blocks	Assembled blocks	Separate blocks	Assembled blocks
0 371 81 or 0 371 80 + 0 375 15 <sup>(1)</sup>	4 W / 6.3 A Pvk = 4.75 W	1.6 W/6.3 A Pvk = 2 W	1.6 W/6.3 A Pv = 1.65 W	-
0 371 87	4 W Pvk = 5 W	2.5 W Pvk = 2.7 W	1.6 W Pv = 1.8 W	-

1: With or without blown fuse indicator Cat.No 0 375 25

### Function blocks

Cat.Nos	Voltage (V)			Current (A)			Nominal cross-section		
	IEC	CSA	UL	IEC	CSA	UL	IEC (mm²)	CSA (AWG)	UL (AWG)
0 371 53	250	-	-	-	-	-	2.5	-	-
0 371 54	250	-	-	1	-	-	2.5	-	-
0 371 55	500	300	300	1	1	1	4	10	10
0 371 56	12 to 24	12 to 24	12 to 24	32	30	30	4	10	10

IEC 60947-7-1, CSA no. 22-2 no. 158, UL 1059

### Schematic diagrams

Cat.No 0 371 53

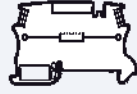

Cat.No 0 371 54

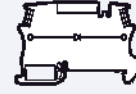

Cat.No 0 371 55

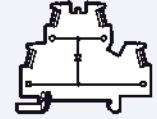

Cat.No 0 371 56

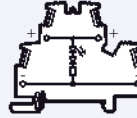

Diode for Cat.Nos 0 371 54/55  
- 1N4007 type 1A  
- direct current = 1 A  
- peak inverse voltage 1000 V  
- inverse current 5 µA at 25 °C

### Blocks for sensors and actuators/PNE

Cat.Nos	Voltage (V)			Current (A)			Nominal cross-section			
	IEC	CSA	UL	le	IEC	CSA	UL	IEC (mm²)	CSA (AWG)	UL (AWG)
0 371 51	400	300	300	27	24	20	20	2.5	12	12
0 371 52										

IEC 60947-7-1/7-2, CSA no. 22-2 no. 158, UL 1059  
le: Rated current NF C 15100 table 52H, column 4

### Disconnect block for measurement

Cat.Nos	Voltage (V)			Current (A)			Nominal cross-section		
	IEC	CSA	UL	IEC	CSA	UL	IEC (mm²)	CSA (AWG)	UL (AWG)
0 371 92	800	-	-	24	-	-	4	-	-

IEC EN 60947-7-1

### Wiring principle for measurement blocks Cat.No 0 371 92

Ammeter circuit

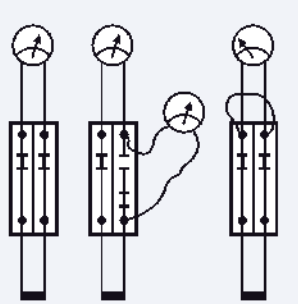

Normal position Test position Short-circuit position

Wattmeter circuit

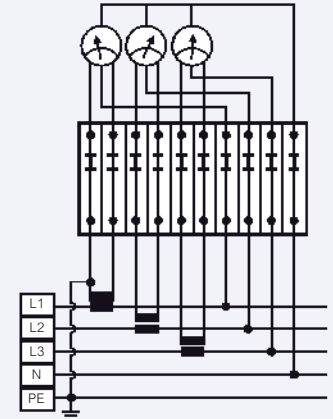

Per circuit:  
2 x Disconnect blocks for measurement  
Cat.No 0 371 92  
4 x Measurement sockets for Ø4 mm plug  
Cat.No 0 375 77  
1 x End cap Cat.No 0 375 57  
1 x Shunt with Ø4 mm plugs

10 x Disconnect blocks for measurement  
Cat.No 0 371 92  
12 x Measurement sockets for Ø4 mm plug  
Cat.No 0 375 77  
1 x End cap Cat.No 0 375 57  
3 x Shunts with Ø4 mm plugs

### Stripped lengths (mm)

Screw terminal pitch (mm)	Rigid or flexible wire
5	6 to 8
6	
8	
10	10 to 12
12	13 to 17 except for Cat.No 0 371 87 : 11 to 14
15	14 to 18
22	15 to 22

### Protection against fire and panic risks in public buildings/UTE C 12-201 guide

Art. EL 3, definitions: "Security installations are those that have to be put into or maintained in service to ensure the evacuation of the public or facilitate the intervention of the first-aid"

Art. EL 16, power supply circuits in security installations section 1a: "...the corresponding junction or deviation devices and their enclosures, except for the waterproofing systems, must satisfy the incandescent wire test defined in the standard in force, the temperature of the incandescent wire being 960 °C"  
Viking 3 terminal blocks satisfy the incandescent wire test 960 °C according to standard IEC 60695-2-11

# Viking™ 3 terminal blocks with spring connection

## Characteristics

V2 polyamide according to UL 94, 960 °C according to IEC EN 60695-2-11  
Insulating material for terminal blocks: polyamide - 30° C to + 100° C

### Connecting blocks

Cat.Nos	Voltage (V)			Current (A)				Nominal cross-section		
	IEC	CSA	UL	le	IEC	CSA	UL	IEC (mm²)	CSA (AWG)	UL (AWG)
0 372 00	800	600	600	36	32	20	20	4	12	12
0 372 01				48	41	30	30	6	10	10
0 372 02				63	57	50	50	10	8	8
0 372 03				85	76	60	60	16	6	6
0 372 04				85	76	60	60	16	6	6
0 372 07	800	600	600	36	32	20	20	4	12	12
0 372 08										
0 372 09										
0 372 20										
0 372 21										
0 372 40										
0 372 41										
0 372 42										
0 372 43										
0 372 44										
0 372 46	500	300	300	36	32	20	20	4	12	12
0 372 61										
0 372 62										
0 372 63										
0 372 64										
0 372 67	800	600	600	36	32	20	20	4	12	12
0 372 68										
0 372 69										

IEC 60947-7-1, CSA no. 22-2 no. 158, UL 1059  
le: Rated current NF C 15100 table 52H, column 4

### Blocks for protection conductor

Cat.Nos	Voltage (V)			Current (A)			Nominal cross-section		
	IEC	CSA	UL	le	IEC	IEC (mm²)	CSA (AWG)	UL (AWG)	
0 372 10	800	600	600	-	-	4	12	12	
0 372 11									
0 372 12									
0 372 70									
0 372 71									
0 372 72									
0 372 73 <sup>(1)</sup>				63	57	10	8	8	
0 372 74 <sup>(1)</sup>				85	76	16	6	6	
0 372 79				-	-	4	12	12	

IEC 60947-7-2, CSA no. 22-2 no. 158, UL 1059  
le: Rated current NF C 15100 table 52H, column 4  
1: PEN terminal blocks

### Function blocks

Cat.Nos	Voltage (V)			Current (A)			Nominal cross-section		
	IEC	CSA	UL	IEC	CSA	UL	IEC (mm²)	CSA (AWG)	UL (AWG)
0 372 54	500	300	300	1	0.6	0.6	4	12	12
0 372 55									
0 372 56				12 to 24	12 to 24	12 to 24	-	-	-

IEC 60947-7-1, CSA no. 22-2 no. 158, UL 1059

### Schematic diagrams

Cat.No 0 372 54



Cat.No 0 372 55

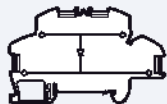

Cat.No 0 372 56

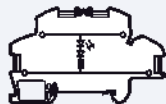

Diode for Cat.Nos 0 372 54/55  
- 1N4007 type 1A  
- direct current = 1 A  
- peak inverse voltage 1000 V  
- inverse current 5 µA at 25 °C

### Approved by ATEX: LCIE 07 ATEX 0010 U-0081 II 1 or 2 G or D Ex e/i/t/d/iD II

The terminal blocks with spring connection covered by this certificate are 1- and 2-level connecting terminal blocks, and blocks for protection conductor with metal base (detailed list on p. 826)

The main characteristics are:

Operating temperature: - 30 °C to + 55 °C  
Maximum temperature of materials: + 85 °C

Working voltage acc. to EN 60079-7: 1-level terminal blocks: 500 V  
2-level terminal blocks: 250 V

Rated current:

Conductor cross-section (mm²)	4	6	10	16	Attestation of conformity of component for the customer is available on request
Rated current (A)	23	30	42	57	

## Disconnect blocks

Cat.Nos	Voltage (V)			Current (A)			Nominal cross-section		
	IEC	CSA	UL	IEC	CSA	UL	IEC (mm²)	CSA (AWG)	UL (AWG)
0 372 80	500	300	300	15	14	14	2.5	14	14
0 372 81 or 0 372 80 + 0 375 15	250	250	250	6.3	6.3	6.3			
0 372 82	500	300	300	15	14	14			
0 372 83									
0 372 84									
0 372 85	500	300	300	15	14	14			
0 372 86	500	300	300	15	14	14			

IEC 60947-7-1/7-3, CSA no. 22-2 no. 158, UL 1059

Power according to IEC 60947-7-3

Cat.Nos	Short-circuit		Short-circuit + overload	
	Separate blocks	Assembled blocks	Separate blocks	Assembled blocks
0 372 81 ou 0 372 80 + 0 375 15 <sup>(1)</sup>	4 W / 6.3 A	1.6 W / 6.3 A	1.6 W / 6.3 A	-
	Pvk = 4.75 W	Pvk = 2 W	Pv = 1.65 W	-

(1): With or without blown fuse indicator Cat.No 0 375 25

## Stripped lengths (mm)

Spring terminal pitch (mm)	Rigid or flexible wire
5	8 to 12
6	
8	
10	8 to 13
12	8 to 15

## Protection against fire and panic risks in public buildings/UTE C 12-201 guide

Art. EL 3, definitions: "Security installations are those that have to be put into or maintained in service to ensure the evacuation of the public or facilitate the intervention of the first-aid"  
Art. EL 16, power supply circuits in security installations section 1a: "...the corresponding junction or deviation devices and their enclosures, except for the waterproofing systems, must satisfy the incandescent wire test defined in the standard in force, the temperature of the incandescent wire being 960 °C"  
Viking 3 terminal blocks satisfy the incandescent wire test 960 °C according to standard IEC 60695-2-11

## Blocks with 5 mm pitch/6 mm pitch

The active part of spring terminal blocks with 5 mm pitch is identical to that of blocks with 6 mm pitch. The absence of an end cap is the only difference between blocks with 5 mm pitch and blocks with 6 mm pitch

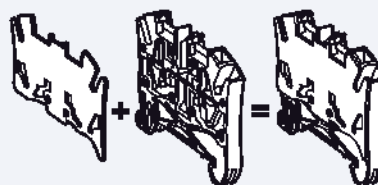

End cap + block with 5 mm pitch

Block with 6 mm pitch and built-in divider

Terminal blocks with 5 mm pitch are therefore 4 mm² nominal / 32 A blocks. Only a connection with end cap limits terminal blocks with 5 mm pitch to 2.5 mm² / 24 A:

	Rigid conductor	Flexible conductor	Flexible conductor with ferrule
Blocks with 5 mm pitch	6 mm² / 32 A	4 mm² / 32 A	2.5 mm² / 24 A
Blocks with 6 mm pitch			4 mm² / 32 A

Spring terminal blocks with 5 mm pitch can therefore reduce the dimensions of 32 A terminal blocks connected with a rigid or flexible conductor without end cap

# Viking™ 3 accessories for terminal blocks

## Characteristics and dimensions (mm)

V2 polyamide according to UL 94

### End stops

Cat.No 0 375 10

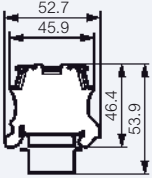

Cat.No 0 375 11

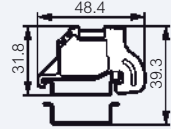

Cat.No 0 375 12

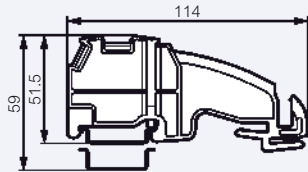

Cat.No 0 375 13

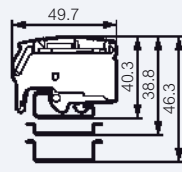

### End caps

Cat.Nos	Thickness (mm)
0 375 50	2
0 375 51	2.5
0 375 52	2
0 375 53	2
0 375 54	2.5
0 375 55	2
0 375 56	1.4
0 375 57	1.4
0 375 58	1
0 375 59	1.1
0 375 60	1.1
0 375 61	1.1
0 375 62	1.1
0 375 63	1.1
0 375 64	1.1
0 375 65	1.1
0 375 66	1.1
0 375 67	1.1
0 375 68	1.1
0 375 69	1.1
0 375 70	1.1
0 375 71	1.1
0 375 72	1.1
0 375 73	1.1
0 375 74	1.1
0 375 75	1.1
0 375 76	1.1
0 375 77	1.1
0 375 78	1.1
0 375 79	1.1
0 375 80	1.1
0 375 81	1.1
0 375 82	1.1
0 375 83	1.1
0 375 84	1.1
0 375 85	1.1
0 375 86	1.1
0 375 87	1.1
0 375 88	1.1
0 375 89	1.1
0 375 90	2

### Separation and insulation dividers

Cat.Nos	Thickness (mm)
0 375 54	2.5
0 375 60	2.5
0 375 61	2.6
0 375 62	2.5
0 375 63	2.5
0 375 95	2.8
0 375 96	2.7

### Equipotential bridging combs/bars

Cat.Nos	Cross-section (mm²)
0 375 00/01	2.5
0 375 02	2.5
0 375 03/04	4
0 375 05	4
0 375 07	6
0 375 08	6
0 375 40	10
0 375 42	16
0 375 44	35
0 375 46	2.5
0 375 47	2.5
0 375 82	10
0 375 85	16

## Shielding clamps

Mounting on bar  
10 x 3 Cat.No 0 375 34

Mounting on rail  
with accessory  
Cat.No 0 364 69

Mounting on plate

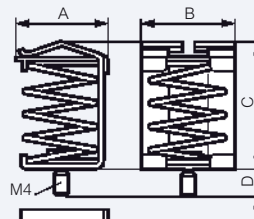
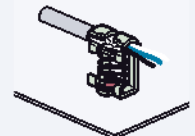
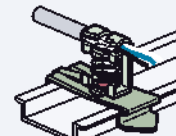
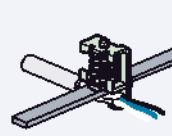

Cat.Nos	A	B	C	D
0 375 30	13.5	18	26	5.6
0 375 31	20	20.3	31.4	5.3
0 375 32	24.8	26	40	5.3

# Viking™ 3 power terminal blocks

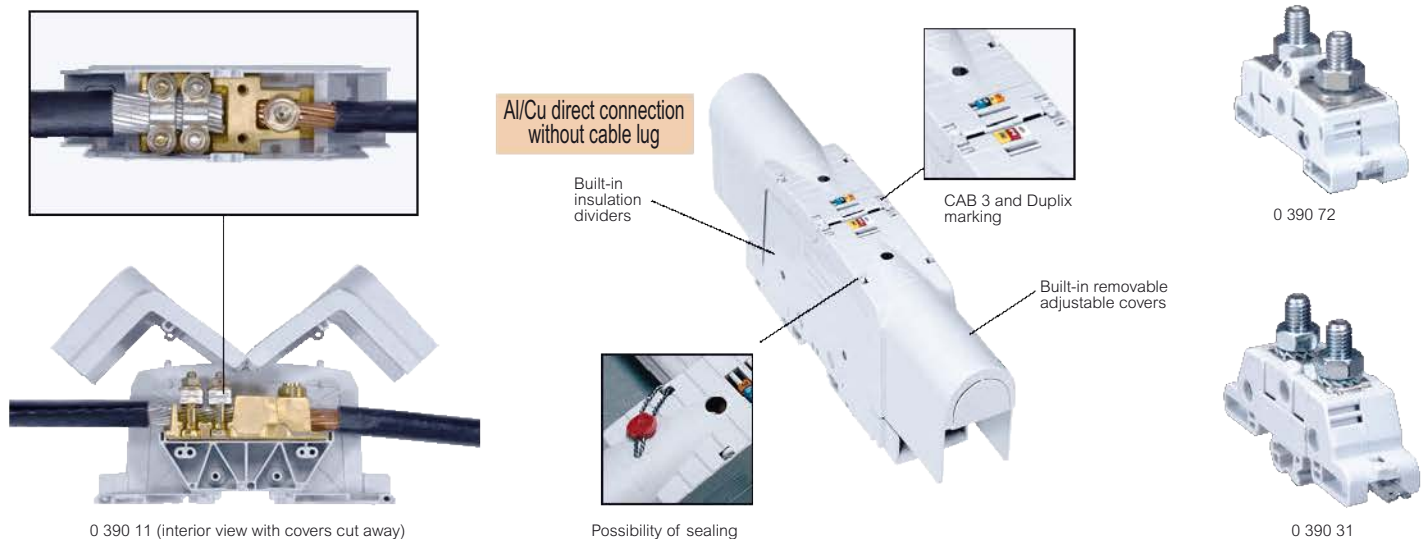

Approvals **p. 826**

Bridging the gap between the enclosure and external cables

Pack	Cat.Nos	<b>Insulated aluminium/copper power terminal blocks</b>		
		For aluminium/copper cables, copper bars or cable lugs (see selection chart p. 291) Direct connection of cable Insulation and protection against direct contact without additional accessories (built-in dividers and covers) Pre-cut removable covers for adjustment to the various connection modes Fixed using metal clip for rails $\sqcup$ 15 mm depth and $\sqcup$ EN 60715 15 mm depth, or on plate with screws Permits the use of Cab 3, Duplix markers Test via test plug closed covers Blocks with identical pitch can be joined using a threaded rod Shunting possible with Cat.Nos 0 394 46/47		
		<b>Cable - cable</b>		
		Rigid or flexible cable (mm <sup>2</sup> )	Rigid or flexible cable (mm <sup>2</sup> )	Pitch (mm)
5	0 390 10	Al/Cu 35 to 120	Cu 35 to 70	42
5	0 390 11	Al/Cu 70 to 300	Cu 70 to 150	55
		<b>Cable lug - cable lug</b>		
		Max. connection (mm <sup>2</sup> )	Max. connection (mm <sup>2</sup> )	Pitch (mm)
5	0 390 13	Al/Cu 95	Al/Cu 95	36
5	0 390 14	Al/Cu 150	Al/Cu 150	42
5	0 390 15	Al/Cu 300	Al/Cu 300	55
		<b>Cable lug - cable</b>		
		Max. connection (mm <sup>2</sup> )	Rigid or flexible cable (mm <sup>2</sup> )	Pitch (mm)
5	0 390 17	Al/Cu 150	Cu 35 to 95	42
5	0 390 18	Al/Cu 300	Cu 70 to 150	55
		<b>Cable - cable lug</b>		
		Rigid or flexible cable (mm <sup>2</sup> )	Max. connection (mm <sup>2</sup> )	Pitch (mm)
5	0 390 20	Al/Cu 35 to 120	Al/Cu 120	42
5	0 390 21	Al/Cu 70 to 300	Al/Cu 300	55
		<b>Equipotential bonding shunts</b>		
		For insulated aluminium/copper power terminal blocks Supplied with screws		
5	0 394 46	For blocks with pitch 36 and 42 mm		
5	0 394 47	For blocks with pitch 55 mm		

Pack	Cat.Nos	<b>Bare power terminal blocks</b>		
		For copper bars or cable lugs Insulation dividers and protective covers to be ordered separately For use with terminal marker sheets (p. 284)		
		<b>Cable lug - cable lug for symmetrical rails</b>		
		Fixed using metal clip on rails $\sqcup$ 15 mm depth and $\sqcup$ EN 60715 15 mm depth		
		Connecting max. (mm <sup>2</sup> )	Pitch (mm)	
5	0 390 71	35	26	
5	0 390 72	70	34	
5	0 390 73	120	34	
5	0 390 74	240	46	
		<b>Cable lug - cable lug for asymmetrical rails</b>		
		Fixed using metal clip on rails $\sqcup$ EN 60715		
5	0 390 31	35	26	
5	0 390 32	70	34	
5	0 390 33	120	34	
5	0 390 34	240	46	
		<b>Insulation and protection accessories</b>		
		For bare power terminal blocks		
		<b>Separation barriers</b>		
		Take protective covers Marking possible with CAB 3 (p. 294)		
10	0 394 77	For blocks with pitch 26 mm		
10	0 394 78	For blocks with pitch 34 and 46 mm		
		<b>Protective covers</b>		
		For mounting on separation barriers		
5	0 394 86	For 3 blocks with pitch 46 mm or for 4 blocks with pitch 34 mm		
5	0 394 88	For 4 blocks with pitch 26 mm		
5	0 394 89	For 4 blocks with pitch 46 mm		



End stops  
**p. 284**

Al/Cu distribution boxes  
**p. 183**

CAB 3 marking system  
**p. 294**

# Viking™ 3 power terminal blocks

## Selection chart

		Output		
		Al bare cable	Cu bare cable	Cu cable lug Al-Cu cable lug Cu bar
Input	Al bare cable	2 shunted blocks: 2x 0 390 10 2x 0 390 11 2x 0 390 20 2x 0 390 21	0 390 10/11	0 390 20/21
	Cu bare cable		0 390 10/11	0 390 17/18/20/21
	Cu cable lug Al-Cu cable lug Cu bar	0 390 20/21	0 390 17/18 0 390 20/21	0 390 13/14/15

Cat.Nos 0 390 10/11  
Cable Al/Cu - Cable Cu



Cat.Nos 0 390 13/14/15  
Cable lug - cable lug



Cat.Nos 0 390 17/18  
Cable lug - Cable Cu



Cat.Nos 0 390 20/21  
Cable Al/Cu - Cable lug



## Characteristics of insulated Al/Cu terminal blocks

Conform to IEC EN 60947-7-1, UL 1059, UL 486 E and CSA C 22-2 n° 158  
Insulation voltage  $U_i$ : 1000 V AC-DC  
Impulse voltage  $U_{imp}$ : 12 kV  
Overvoltage category: 4  
Use in pollution atmosphere 3  
Fire resistance:  
- 960 °C (except cover) acc. to IEC EN 60695-2-11  
- V2 according to UL 94  
Insulating material:  
- polyamide body - 30 °C to + 100 °C  
- polypropylene cover -25 °C to + 100 °C  
IK 04

Block only

Cat.Nos	Current (A)			Icw (kA)	Terminal width (mm)	Ø screw	Tightening torque (Nm)
	Copper - Copper IEC	UL	CSA				
0 390 10	250	200	175	250	8,4	-	15
0 390 11	400	300	285	400	18	-	35
0 390 13	310	250	230	220	11,4	28	M 8
0 390 14	415	340	285	300	18	34	M 10
0 390 15	670	520	420	480	36	46	M 12
0 390 17	315	210	230	315	11,4	34	M 10
0 390 18	420	325	285	420	18	46	M 12
0 390 20	340	235	255	250	8,4	34	M 10
0 390 21	570	375	420	400	18	46	M 12

Shunted block

Block + shunt Cat.Nos	Current (A)		Icw (kA)	Shunt tightening torque (Nm)
	Copper - Copper IEC	Al-Al / Al-Cu / Cu-Al		
0 390 10 + 0 394 46 + 0 390 10	340	250	14,4	6
0 390 11 + 0 394 47 + 0 390 11	570	400	36	10
0 390 13 + 0 394 46 + 0 390 13	310	220	11,4	6
0 390 14 + 0 394 46 + 0 390 14	415	300	18	6
0 390 15 + 0 394 47 + 0 390 15	670	480	36	10
0 390 17 + 0 394 46 + 0 390 17	415	315	18	6
0 390 18 + 0 394 47 + 0 390 18	670	420	36	10
0 390 20 + 0 394 46 + 0 390 20	340	250	14,4	6
0 390 21 + 0 394 47 + 0 390 21	570	400	36	10

## AWG cable cross-sections

mm <sup>2</sup>	35	70	95	120	150	185	300
AWG	2	00	0000	250	300	350	600

## Dimensions (mm)

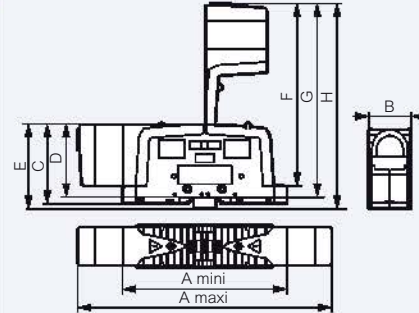

Cat.Nos	A max	A mini	B	C	D	E	F	G	H
0 390 13	227	155	36	82	73	88	176	185	191
0 390 10/14/17/20	296	200	42	83.5	74.5	89.5	212	221	227
0 390 11/15/18/21	337	216	55	107.3	98.5	113.5	257	266	272

## Characteristics of bare terminal blocks

Conform to IEC EN 60947-7-1  
Insulation voltage  $U_i$ : 1000 V AC-DC  
Fire resistance:  
- 960 °C acc. to IEC EN 60695-2-11  
- V2 according to UL 94  
Insulating material: polyamide - 30 °C to + 100 °C

Cat.Nos	Current (A) Copper - Copper IEC	Icw (kA)	Terminal width (mm)	Ø screw	Tightening torque (Nm)
0 390 31/71	125	4,2	15	M 8	10
0 390 32/72	192	8,4	20	M 10	20
0 390 33/73	269	14,4	25	M 10	20
0 390 34/74	415	28,8	35	M 12	40

## Dimensions (mm)

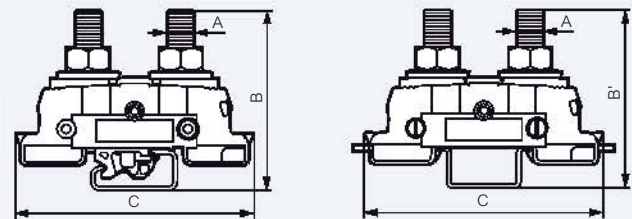

Cat.Nos 0 390 31/32/33/34

Cat.Nos 0 390 71/72/73/74

Cat.Nos	A	B
0 390 31/71	56	84
0 390 32/72	61	84
0 390 33/73	61	84
0 390 34/74	64	86

Cat.Nos	Separation and insulation divider	Protective cover	
		4 blocks	3 blocks
0 390 31/71	0 394 77	0 394 88	-
0 390 32/72	0 394 78	0 394 86	-
0 390 33/73	0 394 78	0 394 86	-
0 390 34/74	0 394 78	0 394 89	0 394 86

## Separation barriers dimensions (mm)



Cat.Nos	A	B	th.
0 394 77	106	82	8
0 394 78	188	102	12

Cat.Nos 0 394 77/78

# Starfix™ ferrules and crimping tools



Correspondence table and dimensions p. 293

Pack	Cat.Nos	Ferrules with insulating flange			
		Provide an equipotential link for all the strands of a copper flexible conductor Active part in tinned electrolytic copper Conform to NF C 63-023			
		<b>Singles - supplied in strips</b>			
		Cross-section (mm <sup>2</sup> )	Colour	Number of strips or sachets	Number of ferrules per strip or sachet
500	0 376 50	0.25	turquoise	10	50
500	0 376 60	0.34	green	10	50
480	0 376 61	0.5	white	12	40
480	0 376 62	0.75	blue	12	40
1000	0 376 63	1	red	25	40
1000	0 376 64	1.5	black	25	40
1000	0 376 66	2.5	grey	25	40
250	0 376 67	4	orange	10	25
250	0 376 68	6	green	10	25
		<b>Singles - individual ferrules (sachet packing)</b>			
500	0 377 50	0.25	turquoise	5	100
500	0 377 60	0.34	green	5	100
1000	0 377 61	0.5	white	10	100
1000	0 377 62	0.75	blue	10	100
1000	0 377 63	1	red	10	100
1000	0 377 64	1.5	black	10	100
1000	0 377 66	2.5	grey	10	100
250	0 377 67	4	orange	5	50
250	0 377 68	6	green	5	50
		<b>Singles - individual ferrules (box packing)</b>			
100	0 376 69	10	brown		
100	0 376 72 <sup>1</sup>	16	white		
100	0 376 70	16	white		
50	0 376 71	25	black		
50	0 376 77	35	red		
30	0 376 78	50	blue		
		<b>Doubles - individual ferrules</b>			
500	0 376 87	2 x 0.75	blue		
500	0 376 88	2 x 1	red		
500	0 376 89	2 x 1.5	black		
500	0 376 90	2 x 2.5	grey		
		<b>Singles - supplied as refills</b>			
		Large capacity for less frequent applicator reloading Translucent refills for direct mounting on crimping tool Cat.No 0 376 09			
		Cross-section (mm <sup>2</sup> )	Colour	Number of ferrules per refills	
3000	0 376 41	0.5	white	300	
3000	0 376 42	0.75	blue	300	
3000	0 376 43	1	red	300	
3000	0 376 44	1.5	black	300	
2500	0 376 45	1.5	grey	250	

1: Short ferrule

Pack	Cat.Nos	Crimping tools for ferrules in strips	
		Cut and crimp of ferrules from 0.25 to 6 mm <sup>2</sup> in one operation	
1	0 376 08	<b>Starfix crimping tool for 0.25 and 0.34 mm<sup>2</sup> cross-sections</b> Supplied fitted with empty applicator	
1	0 376 09	<b>Starfix crimping tool for 0.5 to 2.5 mm<sup>2</sup> cross-sections</b> Supplied fitted with empty applicator	
1	0 376 39	Assorted kit, comprising: - 1 Starfix crimping tool, Cat. No. 0 376 09 fitted with empty applicator - 120 x 0.5 mm <sup>2</sup> ferrules - 120 x 0.75 mm <sup>2</sup> ferrules - 240 x 1 mm <sup>2</sup> ferrules - 320 x 1.5 mm <sup>2</sup> ferrules - 200 x 2.5 mm <sup>2</sup> ferrules	
1	0 376 10	<b>Starfix crimping tool for 4 and 6 mm<sup>2</sup> cross-sections</b> Supplied fitted with empty applicator	
1	0 376 97	<b>Starfix S multi-purpose crimping tool for 0.5 to 2.5 mm<sup>2</sup> cross-sections</b> Tool cuts, strips, twists and crimps wire Supplied with 5 empty applicators	
		<b>4-point crimping tool for individual single and double ferrules</b>	
		For right or left-handed	
1	0 376 06	<b>Starfix crimping tool for 0.25 to 6 mm<sup>2</sup> cross-sections</b> For crimping of 0.25 to 6 mm <sup>2</sup> cross section ferrules Crimping tool with disengageable control system, crimping at end	
1	0 376 92	<b>Starfix crimping tool for 10 to 50 mm<sup>2</sup> cross-sections</b> Assorted kit comprising: - 1 crimping tool with disengageable control system for individual ferrules 10 to 50 mm <sup>2</sup> - 30 individual ferrules 10 mm <sup>2</sup> - 20 individual ferrules 16 mm <sup>2</sup> - 15 individual ferrules 25 mm <sup>2</sup> - 10 individual ferrules 35 mm <sup>2</sup> - 10 individual ferrules 50 mm <sup>2</sup>	

# Starfix™ applicator

# Starfix™ ferrules and crimping tools

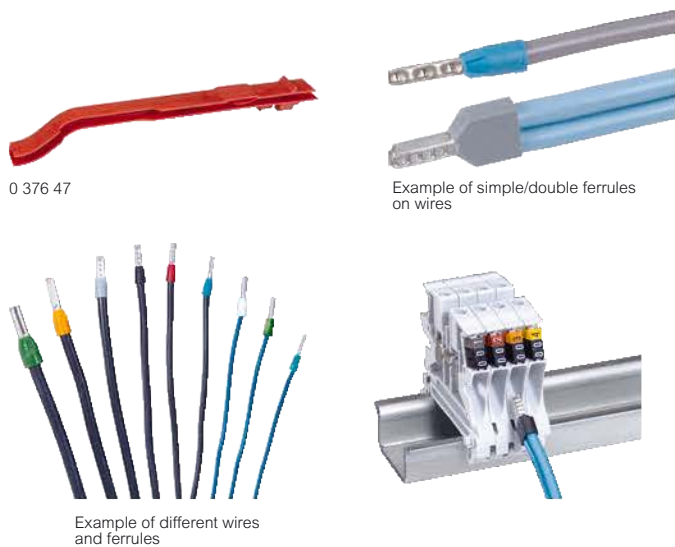

Pack	Cat.Nos	Starfix applicator	For Starfix crimping tool	For ferrules cross-section (mm <sup>2</sup> )	Colour
10	0 376 46			0.25 and 0.34	yellow
10	0 376 47			0.5 to 2.5	red
10	0 376 48			4 and 6	orange

## Correspondence table

Cross-section (mm <sup>2</sup> )	Simple ferrule	Large capacity ferrule - refills	Starfix applicator
0.5	0 376 61	0 376 41	0 376 47
0.75	0 376 62	0 376 42	0 376 47
1	0 376 63	0 376 43	0 376 47
1.5	0 376 64	0 376 44	0 376 47
2.5	0 376 66	0 376 45	0 376 47

## Dimensions (mm)

### Simple ferrules

Cat.Nos		Cross-section (mm <sup>2</sup> )	A	B	C	D
0 376 50	0 377 50	0.25	8	14.5	1.1	3
0 376 60	0 377 60	0.34	8	14.5	1.1	3
0 376 61	0 377 61	0.5	8	14.5	1.5	3.4
0 376 62	0 377 62	0.75	8	14.5	1.5	3.4
0 376 63	0 377 63	1	8	14.5	1.7	3.6
0 376 64	0 377 64	1.5	8	14.5	2	4.1
0 376 66	0 377 66	2.5	8	14.5	2.6	4.8
0 376 67	0 377 67	4	12	21	3.2	5.7
0 376 68	0 377 68	6	12	23	3.9	7.2
0 376 69		10	12	21	4.9	8.1
0 376 72		16	12	23	6.3	9.8
0 376 70		16	18	29	6.3	9.8
0 376 71		25	18	31	7.9	12
0 376 77		35	18	32	8.9	13.5
0 376 78		50	20	36	11.1	16.1

### Double ferrules

Cat.Nos	Cross-section (mm <sup>2</sup> )	A	B	C	D	E
0 376 87	2 x 0.75	8	15	2.1	6	3.3
0 376 88	2 x 1	8	15	2.35	6	4
0 376 89	2 x 1.5	8	16	2.6	7.2	4.2
0 376 90	2 x 2.5	10	18.5	3.3	8.4	4.8

## Example of use

### Starfix tool Cat.Nos 0 376 08/09/10/39



### Starfix S tool Cat.No 0 376 97



## CAB 3™ marking system

for wiring and Viking 3 terminal blocks



0 381 51



0 381 64

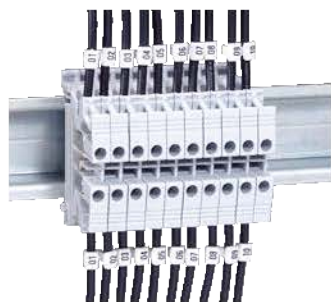

Same markers for cable and terminal blocks



0 381 63 mounted on Viking 3 terminal blocks

Technical characteristics p. 296

For marking wiring or Viking 3 terminal blocks

Pack	Cat.Nos	Markers for wiring 0.5 to 1.5 mm <sup>2</sup> cross-section and terminal blocks
		Strips of 20 markers (price per marker) Numbers: black on white background (available in black on yellow background on request)
240	0 381 50	01 to 20
240	0 381 51	21 to 40
240	0 381 52	41 to 60
240	0 381 53	61 to 80
240	0 381 54	81 to 100
240	0 381 55	Blank



0 381 51

Pack	Cat.Nos	Markers for wiring 1.5 to 2.5 mm <sup>2</sup> cross-section and terminal blocks
		Strips of 20 markers (price per marker) Numbers: black on white background (available in black on yellow background on request)
240	0 381 60	01 to 20
240	0 381 61	21 to 40
240	0 381 62	41 to 60
240	0 381 63	61 to 80
240	0 381 64	81 to 100
240	0 381 65	Blank



0 381 64

## Marking label sheets

for Viking 3 terminal blocks



0 395 05 on Viking 3 terminal blocks



0 395 20



0 395 98

For marking Viking 3 terminal blocks

Pack	Cat.Nos	Blank markers
		Displayed by sheet of 100 pre-cut markers Manual marking (price per marker)
1000	0 395 00	For blocks 5 mm pitch
1000	0 395 01	For blocks 6 mm pitch
1000	0 395 02	For blocks 8 mm pitch

Pack	Cat.Nos	Numbers
		Correct reading direction with the marker in horizontal position. Price per marker.
		<b>Pitch of 5 mm</b>
1000	0 395 05	From 1 to 10 (10 times)
1000	0 395 06	From 11 to 20 (10 times)
1000	0 395 07	From 21 to 30 (10 times)
1000	0 395 08	From 31 to 40 (10 times)
1000	0 395 09	From 1 to 50 (2 times)
1000	0 395 10	From 1 to 100
1000	0 395 11	From 101 to 200
		<b>Pitch of 6 mm</b>
1000	0 395 15	From 1 to 10 (10 times)
1000	0 395 16	From 11 to 20 (10 times)
1000	0 395 17	From 21 to 30 (10 times)
1000	0 395 18	From 31 to 40 (10 times)
1000	0 395 19	From 1 to 50 (2 times)
1000	0 395 20	From 1 to 100
1000	0 395 21	From 101 to 200

Pack	Cat.Nos	Black felt tip pen
10	0 395 98	Indelible for marking



# CAB 3™ marking system

markers for wiring and Viking 3 terminal blocks



Perfect alignment of label holders



0 382 12

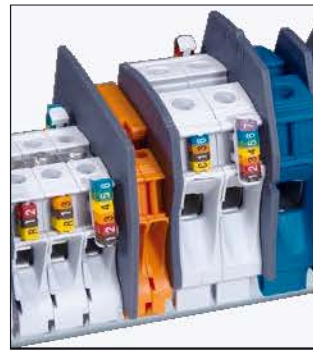

Terminal block with CAB 3 markers and label-holders

For marking wiring or Viking 3 terminal blocks

Pack	Cat.Nos		<b>Markers for wiring 0.15 to 0.5 mm<sup>2</sup> and 0.5 to 1.5 mm<sup>2</sup> cross-section and terminal blocks</b> On Viking 3 terminal blocks - 4 markers 0.15 to 0.5 mm <sup>2</sup> max - 3 markers 0.15 to 1.5 mm <sup>2</sup> max. Pack: - Up to 0.5 mm <sup>2</sup> : strips of 25 markers From 0.5 mm <sup>2</sup> to 2.5 mm <sup>2</sup> : strips of 30 markers Price per marker <b>Digits: international colour code</b>
	0.15 to 0.5 <sup>2</sup>	0.5 to 1.5 <sup>2</sup>	
1000 1200	0 381 00	0 382 10	0 Black
1000 1200	0 381 01	0 382 11	1 Brown
1000 1200	0 381 02	0 382 12	2 Red
1000 1200	0 381 03	0 382 13	3 Orange
1000 1200	0 381 04	0 382 14	4 Yellow
1000 1200	0 381 05	0 382 15	5 Green
1000 1200	0 381 06	0 382 16	6 Blue
1000 1200	0 381 07	0 382 17	7 Purple
1000 1200	0 381 08	0 382 18	8 Grey
1000 1200	0 381 09	0 382 19	9 White
			<b>Letters: black on yellow background</b>
300	0 381 10	0 383 00	A
300	0 381 11	0 383 01	B
300	0 381 12	0 383 02	C
300	0 381 13	0 383 03	D
300	0 381 14	0 383 04	E
300	0 381 15	0 383 05	F
300	0 381 16	0 383 06	G
300	0 381 17	0 383 07	H
300	0 381 18	0 383 08	I
300	0 381 19	0 383 09	J
300	0 381 20	0 383 10	K
300	0 381 21	0 383 11	L
300	0 381 22	0 383 12	M
300	0 381 23	0 383 13	N
300	0 381 24	0 383 14	O
300	0 381 25	0 383 15	P
300	0 381 26	0 383 16	Q
300	0 381 27	0 383 17	R
300	0 381 28	0 383 18	S
300	0 381 29	0 383 19	T
300	0 381 30	0 383 20	U
300	0 381 31	0 383 21	V
300	0 381 32	0 383 22	W
300	0 381 33	0 383 23	X
300	0 381 34	0 383 24	Y
300	0 381 35	0 383 25	Z
			<b>Conventional symbols: black on yellow background</b>
300	0 381 40	0 382 70	/
300	0 381 41	0 382 71	•
300	0 381 42	0 382 72	+
300	0 381 43	0 382 73	-
300	0 381 44	0 382 74	~
300	0 381 45	0 382 75	≡
300	0 381 46	0 382 76	⊕

Pack	Cat.Nos		<b>Markers for wiring 1.5 to 2.5 mm<sup>2</sup> and 4 to 6 mm<sup>2</sup> cross-section</b> Pack: From 0.5 mm <sup>2</sup> to 2.5 mm <sup>2</sup> : strips of 30 markers - Upper 2.5 mm <sup>2</sup> : strips of 20 markers Price per marker <b>Digits: international colour code</b>
	1,5 to 2,5 <sup>2</sup>	4 to 6 <sup>2</sup>	
1200 800	0 382 20	0 382 30	0 Black
1200 800	0 382 21	0 382 31	1 Brown
1200 800	0 382 22	0 382 32	2 Red
1200 800	0 382 23	0 382 33	3 Orange
1200 800	0 382 24	0 382 34	4 Yellow
1200 800	0 382 25	0 382 35	5 Green
1200 800	0 382 26	0 382 36	6 Blue
1200 800	0 382 27	0 382 37	7 Purple
1200 800	0 382 28	0 382 38	8 Grey
1200 800	0 382 29	0 382 39	9 White
			<b>Letters: black on yellow background</b>
300	0 383 30	0 383 60	A
300	0 383 31	0 383 61	B
300	0 383 32	0 383 62	C
300	0 383 33	0 383 63	D
300	0 383 34	0 383 64	E
300	0 383 35	0 383 65	F
300	0 383 36	0 383 66	G
300	0 383 37	0 383 67	H
300	0 383 38	0 383 68	I
300	0 383 39	0 383 69	J
300	0 383 40	0 383 70	K
300	0 383 41	0 383 71	L
300	0 383 42	0 383 72	M
300	0 383 43	0 383 73	N
300	0 383 44	0 383 74	O
300	0 383 45	0 383 75	P
300	0 383 46	0 383 76	Q
300	0 383 47	0 383 77	R
300	0 383 48	0 383 78	S
300	0 383 49	0 383 79	T
300	0 383 50	0 383 80	U
300	0 383 51	0 383 81	V
300	0 383 52	0 383 82	W
300	0 383 53	0 383 83	X
300	0 383 54	0 383 84	Y
300	0 383 55	0 383 85	Z
			<b>Conventional symbols: black on yellow</b>
300	0 382 80	0 382 90	/
300	0 382 81	0 382 91	•
300	0 382 82	0 382 92	+
300	0 382 83	0 382 93	-
300	0 382 84	0 382 94	~
300	0 382 85	0 382 95	≡
300	0 382 86	0 382 96	⊕

# CAB 3™ marking system

accessories



Pack	Cat.Nos	CAB 3 accessories
100	0 384 90	10 to 16 mm <sup>2</sup> cross-section
50	0 384 91	25 to 35 mm <sup>2</sup> cross-section
50	0 384 92	50 to 70 mm <sup>2</sup> cross-section
100	0 383 92	Support for markers
10	0 383 94	0.15 to 0.5 mm <sup>2</sup>
10	0 383 95	0.5 to 1.5 mm <sup>2</sup>
10	0 383 96	1.5 to 2.5 mm <sup>2</sup>
10	0 383 97	4 to 6 mm <sup>2</sup>
1	0 382 01	0.15 to 0.5 mm <sup>2</sup> : 2500 markers + 10 applicators (250 digits from 0 to 9)
1	0 382 02	0.5 to 1.5 mm <sup>2</sup> : 3000 markers + 10 applicators (300 digits from 0 to 9)
1	0 382 03	1.5 to 2.5 mm <sup>2</sup> : 3000 markers + 10 applicators (300 digits from 0 to 9)
1	0 382 04	4 to 6 mm <sup>2</sup> : 2000 markers + 10 applicators (200 digits from 0 to 9)
1	0 382 00	On-site toolbox

### Marker-holders

For cables cross-section from 10 mm<sup>2</sup> to 70 mm<sup>2</sup>  
Capacity: 8 digits, letters or symbols markers from 0.5 to 1.5 mm<sup>2</sup> or 1.5 to 2.5 mm<sup>2</sup> cross section  
Black

### Support for markers

Can be clipped on Viking 3 terminal blocks with screw connection  
Capacity:  
7 markers from 0.15 to 0.5 mm<sup>2</sup>  
6 markers from 0.5 to 1.5 mm<sup>2</sup>

### Transparent applicators

For rapid selection and application of markers onto cable (except Cat.No 0 381 50 to 0 381 55 and Cat.No 0 381 60 to 0 381 65)

For markers cross-section (mm <sup>2</sup> )	Applicator colour for identification of cross-section
0.15 to 0.5	green
0.5 to 1.5	red
1.5 to 2.5	blue
4 to 6	yellow

### Set of markers (digits)

0.15 to 0.5 mm<sup>2</sup>: 2500 markers + 10 applicators (250 digits from 0 to 9)  
0.5 to 1.5 mm<sup>2</sup>: 3000 markers + 10 applicators (300 digits from 0 to 9)  
1.5 to 2.5 mm<sup>2</sup>: 3000 markers + 10 applicators (300 digits from 0 to 9)  
4 to 6 mm<sup>2</sup>: 2000 markers + 10 applicators (200 digits from 0 to 9)

### On-site toolbox

With removable tray for CAB 3 markers and applicators, Starfix ferrules...  
Height 85 mm, depth 280 mm, width 450 mm  
Metal, padlockable  
Supplied empty

# CAB 3™ marking system

for wiring and Viking 3 terminal blocks

## Dimensions

**Markers**  
Polyamide 6/6

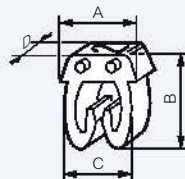

Dimensions	Cable cross-section (mm <sup>2</sup> )			
	0.15 to 0.5	0.5 to 1.5	1.5 to 2.5	4 to 6
A (mm)	5	5	5.6	8
B (mm)	5.05	6.4	7.6	9.6
C (mm)	3.7	4.3	4.9	7.1
D (mm)	2.3	3	3	3
Ø mini/maxi (mm)	0.8/2.2	2.2/3	2.8/3.8	4.3/5.3

Cat.Nos 0 381 50 to 0 381 55 et 0 381 60 to 0 381 65: no liking stud.  
D = 6 mm

## Marker holders

Cat.No 0 384 90

Cat.No 0 384 91

Cat.No 0 384 92

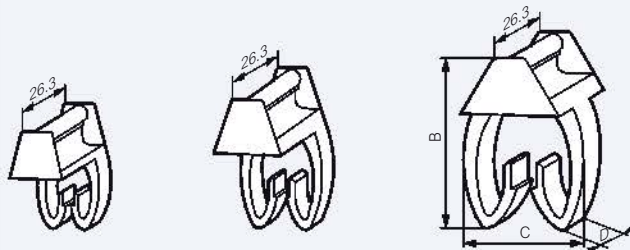

Dim.	Section of cable for marking (mm <sup>2</sup> )		
	10 to 16	25 to 35	50 to 70
B (mm)	18	24.3	27.2
C (mm)	8.9	12.2	17.2
D (mm)	7	7	10

## Support for markers Cat.No 0 383 92

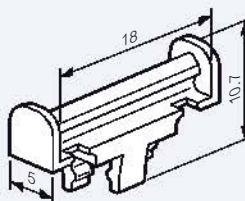

## Characteristics and dimensions of on-site toolbox

Cat.No 0 382 00

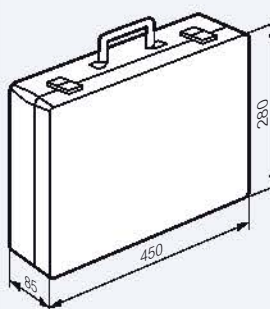

Bottom tray consists of:

- 8 medium slots (around 8 CAB 3 boxes)
- 1 large slot

Top tray consists of:

- 12 small slots (<=> approx. 6 boxes of CAB 3)
- 1 medium slot for applicators

Capacity: approx. 15000 CAB 3 markers

## Examples

On terminal blocks with support Cat.No 0 383 92



On power terminal blocks

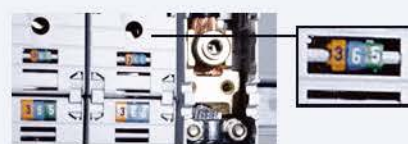

On cable with marker-holder Cat.No 0 384 92



# Memocab™ marking system

for wiring



0 377 12 fixed with Colring cable tie



0 379 91



0 379 92



0 379 89



0 379 93



Marking kit on request

Marking system with closed ring  
High resistance in very aggressive environments

## Pack Cat.Nos Marker-holders for wiring

Pack	Cat.Nos	Length of marking: 12 mm			
		Section (mm²)		Ø (mm)	
		min.	max.	min.	max.
1000	0 379 27	0.25	1.5	1.3	3.5
1000	0 379 28	0.75	4	2.3	4.8
Length of marking: 15 mm					
6 markers					
1000	0 379 30	0.25	1.5	1.3	3.5
1000	0 379 31	0.75	4	2.3	4.8
500	0 379 32	4	16	4.2	7.6
Length of marking: 18 mm					
7 markers					
1000	0 379 36	0.25	1.5	1.3	3.5
1000	0 379 37	0.75	4	2.3	4.8
500	0 379 38	4	16	4.2	7.6
500	0 379 33	16	50	7.6	12.5
200	0 379 34	50	95	12.5	19
100	0 379 35	95	300	19	29.5
Length of marking: 30 mm					
7 markers					
500	0 379 40	0.25	1.5	1.3	3.5
500	0 379 41	0.75	4	2.3	4.8
200	0 379 42	4	16	4.2	7.6
200	0 379 43	16	50	7.6	12.5
Length 500 mm (to be cut)					
10	0 379 44	0.75	4	2.3	4

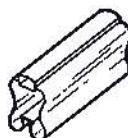
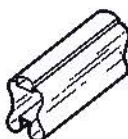
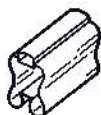

## Pack Cat.Nos Marker-holders for cables

		Fixing with Colring cable ties	
100	0 377 12	Length of marking: 20 mm (8 markers)	
200	0 387 42	Length of marking: 30 mm (12 markers)	
Marker-holders for all devices			
100	0 377 10	Adhesive Length of marking: 17.5 mm (7 markers)	
Accessories			
Double dispenser board			
1	0 379 91	For 48 strips of markers (supplied empty)	
Selecting prong			
		For selecting the markers and placing them in the label holder	
10	0 379 90	For 30 mm marker holders	
10	0 379 92	For 15 mm marker holders	
10	0 379 89	Double for 30 or 18 mm marker holders (for simultaneous marking of both ends)	
Extractor			
10	0 379 93	For 15 mm marker holders	

## Marker-holders for simultaneous marking of both ends

Pre-cut label holders in rolls

### Length of marking: 18 mm

7 markers

	Pack	Cat.Nos	Section (mm²)		Ø (mm)	
			min.	max.	min.	max.
1000		0 379 20	0.25	1.5	1.3	3.5
1000		0 379 21	0.75	4	2.3	4.8
500		0 379 22	4	16	4.2	7.6

### Length of marking: 30 mm

12 markers

500		0 379 10	0.25	1.5	1.3	3.5
500		0 379 11	0.75	4	2.3	4.8

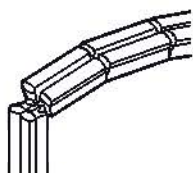

Colring cable ties  
p. 272

Duplix cable marking system  
p. 571

Logicab™ 2 refills  
Please, consult us

# Memocab™ marking system

for wiring (continued)



0 378 01 to 0 378 10



0 378 05 + 2 x 0 378 06 + 0 378 01  
+ 0 378 10 + 0 378 09 + 0 378 08  
in a label holder Cat.No 0 379 38

Pack	Cat.Nos	Markers
------	---------	---------

Supplied in strips of 24 markets (unit price per marker)

### Numbers on colour background

Black or white marking  
(international colour code)

600	0 378 01	Purple	7
600	0 378 02	Orange	3
600	0 378 03	White	9
600	0 378 04	Grey	8
600	0 378 05	Green	5
600	0 378 06	Yellow	4
600	0 378 07	Brown	1
600	0 378 08	Blue	6
600	0 378 09	Black	0
600	0 378 10	Red	2



0 378 06

### Numbers on white background

Black marking

600	0 377 80	0
600	0 377 81	1
600	0 377 82	2
600	0 377 83	3
600	0 377 84	4
600	0 377 85	5
600	0 377 86	6
600	0 377 87	7
600	0 377 88	8
600	0 377 89	9



0 377 85

### Capital letters

Black marking on white background

240	0 378 26	A
240	0 378 27	B
240	0 378 28	C
240	0 378 29	D
240	0 378 30	E
240	0 378 31	F
240	0 378 32	G
240	0 378 33	H
240	0 378 34	I
240	0 378 35	J
240	0 378 36	K
240	0 378 37	L
240	0 378 38	M
240	0 378 39	N
240	0 378 40	O
240	0 378 41	P
240	0 378 42	Q
240	0 378 43	R
240	0 378 44	S
240	0 378 45	T
240	0 378 46	U
240	0 378 47	V
240	0 378 48	W
240	0 378 49	X
240	0 378 50	Y
240	0 378 51	Z



0 378 30

### Conventional symbols

Black marking on white background

240	0 379 54	/
240	0 379 55	•
240	0 379 56	+
240	0 379 57	-
240	0 379 58	~
240	0 379 59	≡
240	0 379 60	⊥



0 379 56

# Memocab™ marking system

for wiring

## Installation



1 Simultaneous marking of both ends



2 Use of double selecting prong



3 Installation in double marker-holder

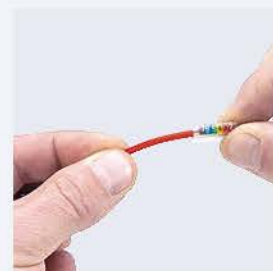

The double strip can be used on site, where each marker-holders of both side will be placed on conductors

# Transcab cable ducting



Approvals **p. 826**  
 Technical characteristics **p. 301**

- 6.5 mm wide fingers with a 6 mm spacing
- Accepts up to 6 mm<sup>2</sup> without breaking side wall finger
- Two pre-scored lines allow removal of fingers
- Bump on side wall fingers help cabling
- Rounded fingers prevent injury during cabling
- Conform to EN 500 85 parts 2 and 3
- Plastic cable ducting (base + cover)
- Side perforations at intervals of 12.5 mm
- Length: 2 m

Pack	Cat.Nos	Light grey halogen free	
		PC/ABS	
		Width x Height (mm)	Capacity (mm <sup>2</sup> )
60 <sup>1</sup>	6 362 00	25 x 25	391
56 <sup>1</sup>	6 362 01	25 x 40	720
56 <sup>1</sup>	6 362 02	25 x 60	1159
48 <sup>1</sup>	6 362 06	40 x 40	1245
48 <sup>1</sup>	6 362 07	40 x 60	2007
40 <sup>1</sup>	6 362 08	40 x 80	2717
32 <sup>1</sup>	6 362 12	60 x 60	3115
32 <sup>1</sup>	6 362 13	60 x 80	4216
24 <sup>1</sup>	6 362 17	80 x 80	5715
16 <sup>1</sup>	6 362 25	120 x 80	8729

1: Number of meters in pack

Pack	Cat.Nos	Grey RAL 7030	
		PVC	
		Width x Height (mm)	Capacity (mm <sup>2</sup> )
32 <sup>1</sup>	6 360 95	15 x 25	264
40 <sup>1</sup>	6 360 96	15 x 40	455
60 <sup>1</sup>	6 361 00	25 x 25	391
56 <sup>1</sup>	6 361 01	25 x 40	720
56 <sup>1</sup>	6 361 02	25 x 60	1159
40 <sup>1</sup>	6 361 03	25 x 80	1600
56 <sup>1</sup>	6 361 05	40 x 25	692
48 <sup>1</sup>	6 361 06	40 x 40	1245
48 <sup>1</sup>	6 361 07	40 x 60	2007
40 <sup>1</sup>	6 361 08	40 x 80	2717
24 <sup>1</sup>	6 361 09	40 x 100	3354
32 <sup>1</sup>	6 361 11	60 x 40	1932
32 <sup>1</sup>	6 361 12	60 x 60	3115
32 <sup>1</sup>	6 361 13	60 x 80	4216
24 <sup>1</sup>	6 361 14	60 x 100	5216
24 <sup>1</sup>	6 361 15	80 x 40	2647
24 <sup>1</sup>	6 361 16	80 x 60	4200
24 <sup>1</sup>	6 361 17	80 x 80	5715
20 <sup>1</sup>	6 361 18	80 x 100	7078
24 <sup>1</sup>	6 361 19	100 x 40	3363
24 <sup>1</sup>	6 361 20	100 x 60	5307
16 <sup>1</sup>	6 361 21	100 x 80	7215
16 <sup>1</sup>	6 361 22	100 x 100	8960
16 <sup>1</sup>	6 361 24	120 x 60	6403
16 <sup>1</sup>	6 361 25	120 x 80	8729
12 <sup>1</sup>	6 361 23	150 x 100	13683

1: Number of meters in pack



# Lina 25™ cable ducting

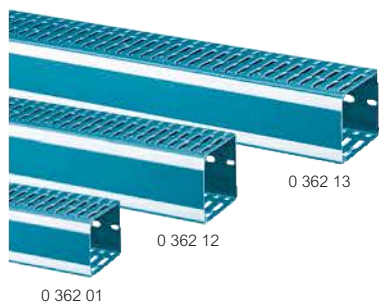

Manually separable trunking



Side wall fingers can be cut using the Lina 25 cutter tool  
Cat.No 0 367 10

Technical characteristics **p. 301**  
Approvals **p. 826**

Pack	Cat.Nos	<b>Lina 25 ducting</b>
		<p>RAL 2525 blue PVC Conform to EN 50085-2-3 6.5 mm wide fingers with a 6 mm spacing Accepts up to 6 mm<sup>2</sup> without breaking side wall fingers Two pre-scored lines allow removal of fingers Bump on side wall fingers help cabling Rounded fingers prevent injury during cabling Conform to EN 50085 parts 2 and 3 Plastic cable ducting (base + cover) Side perforations at intervals of 12.5 mm Length: 2 m Width x height (mm)</p>
60 <sup>1</sup>	0 362 00	25 x 25
56 <sup>1</sup>	0 362 01	25 x 40
56 <sup>1</sup>	0 362 02	25 x 60
40 <sup>1</sup>	0 362 03	25 x 80
56 <sup>1</sup>	0 362 05	40 x 25
48 <sup>1</sup>	0 362 06	40 x 40
48 <sup>1</sup>	0 362 07	40 x 60
40 <sup>1</sup>	0 362 08	40 x 80
32 <sup>1</sup>	0 362 11	60 x 40
32 <sup>1</sup>	0 362 12	60 x 60
32 <sup>1</sup>	0 362 13	60 x 80
24 <sup>1</sup>	0 362 16	80 x 60
24 <sup>1</sup>	0 362 17	80 x 80
16 <sup>1</sup>	0 362 25	120 x 80

Pack	Cat.Nos	<b>Lina 25 cutter tool</b>
1	0 367 10	For a straight break of side wall fingers

Pack	Cat.Nos	<b>Sleeving</b>						
		<p><b>Braided sleeving</b> Black polyester Supplied in 50 m roll in dispenser box with an indicator 3 m before end</p> <table border="1"> <thead> <tr> <th>Ø of roll</th> <th>Ø variations</th> </tr> </thead> <tbody> <tr> <td>20 mm</td> <td>10 to 30 mm</td> </tr> <tr> <td>30 mm</td> <td>18 to 54 mm</td> </tr> </tbody> </table> <p><b>Spiral sleeving</b> Colourless</p>	Ø of roll	Ø variations	20 mm	10 to 30 mm	30 mm	18 to 54 mm
Ø of roll	Ø variations							
20 mm	10 to 30 mm							
30 mm	18 to 54 mm							
1	0 366 38	Ø12 mm						
1	0 366 39	Ø22 mm						
25	6 361 78							
25	6 361 83							



Pack	Cat.Nos	<b>Black felt-tip pen</b>
10	0 395 98	Black felt-tip pen indelible for marking

1: Number of metres in pack

## Linafix isolating fixing accessories

Pack	Cat.Nos	Material polyamide 6/6
20	0 367 00	<p>Enable fixing of cable ducting on any support by 1/4 turn On chassis-rail Holds the ducting in place vertically</p>
100	0 366 40	<p>On rails □, L 15 mm depth 1/4 turn</p>
20	0 366 41	<p>On Lina 25 perforated plates Clip-on 1/4 turn</p>
20	0 366 42	<p>On door Fits under control and signalling auxiliaries Osmoz (Ø22)</p>
10	0 366 43	<p>On Lina 25 uprights Double adjustment to enable alignment with the perforations at the bottom of cable ducting Can be used to fix vertical or horizontal ducting (possible reinforcement with rail L, 15 mm depth)</p>
100	0 366 46	<p>On plain plates plastic rivet length 12 mm for solid plates up to 30 / 10<sup>th</sup> Drilling Ø: 5.5 to 6 mm</p>
500	0 366 44	<p>On plain plates, Lina 12.5 and perforated plates, Lina 25 for cabinets Reinforced plastic rivet Ø6 mm Drilling Ø: 6.5 mm</p>
100	0 347 45	<p>Screw caps H 4.8 x 16 mm self-drilling, self-tapping for Ø3.3 mm</p>
200	0 347 50	<p>Screw cover, for isolating screws head Cat.No 0 347 45 inside the trunking</p>
50	0 367 01	<p>Cable retainer To clip-on the fingers</p>

# Transcab and Lina 25™ cable ducting

## Lina 25 installation



Linear positioning

"I" junction

Cut at two different levels for cable ducting

## Lina 25 accessories installation

Fixing on rail

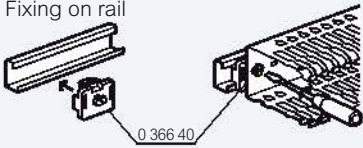

Fixing on perforated plate

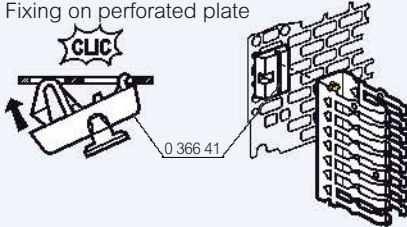

Fixing on door

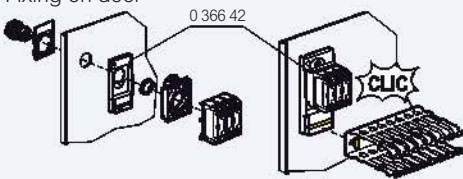

Cable retainer

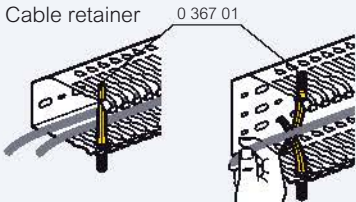

## Dimensions

Width 15 mm (Transcab)

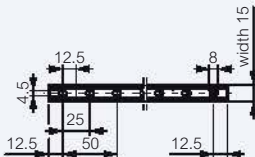

Width 25 to 60 mm (Transcab and Lina 25)

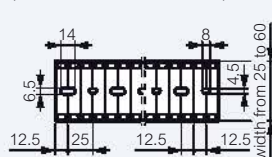

Width 80 to 120 mm (Transcab and Lina 25)

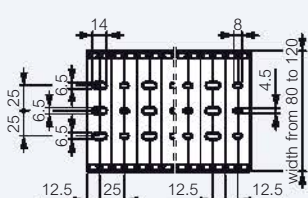

Width 150 mm (Transcab)

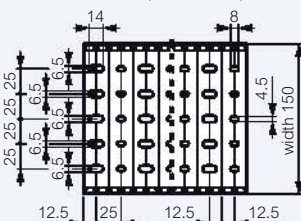

## Dimensions (continued)

Transcab cable ducting

Cat.Nos	A (mm)	B (mm)
6 360 95	15	25
6 360 96	15	40
6 361 00/6 362 00	25	25
6 361 01/6 362 01	25	40
6 361 02/6 362 02	25	60
6 361 03	25	80
6 361 05	40	25
6 361 06/6 362 06	40	40
6 361 07/6 362 07	40	60
6 361 08/6 362 08	40	80
6 361 09	40	100
6 361 11	60	40
6 361 12/6 362 12	60	60
6 361 13/6 362 13	60	80
6 361 14	60	100
6 361 15	80	40
6 361 16	80	60
6 361 17/6 362 17	80	80
6 361 18	80	100
6 361 19	100	40
6 361 20	100	60
6 361 21	100	80
6 361 22	100	100
6 361 24	120	60
6 361 25/6 362 25	120	80
6 361 23	150	100

Lina 25 cable ducting

Cat.Nos	A (mm)	B (mm)	C (mm)
0 362 00	25	25	6
0 362 01	25	40	5
0 362 02	25	60	6
0 362 03	25	80	6
0 362 05	40	25	10
0 362 06	40	40	10
0 362 07	40	60	10
0 362 08	40	80	10
0 362 11	60	40	10
0 362 12	60	60	10
0 362 13	60	80	10
0 362 16	80	60	10
0 362 17	80	80	10
0 362 25	120	80	10

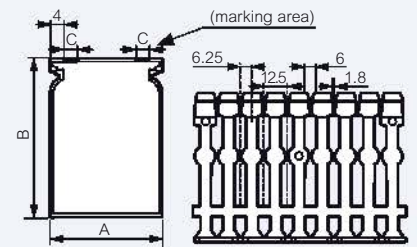

## Calculating the ducting usable cross-section

Graph for H 05 V-K and H 07 V-K cables with 0.75 packing coefficient

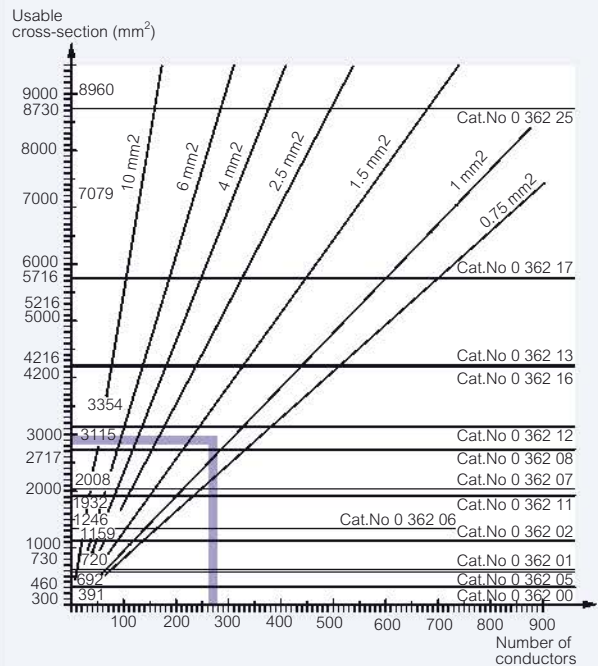

Example :

150 conductors 0.75 mm<sup>2</sup> -> 1230 mm<sup>2</sup> cross-section and  
 120 conductors 1.5 mm<sup>2</sup> -> 1700 mm<sup>2</sup> cross-section  
 Makes a total of 2930 mm<sup>2</sup>  
 The correct cable ducting is Cat.No 0 362 12, 60 x 60,  
 with a capacity of 3115 mm<sup>2</sup>

## Norm EN 50085-2-3

### Classification of Transcab and Lina 25 cable ducting

6.3 Minimum storage and transport temperature	- 25 °C
6.3 Maximum operating temperature	+ 60 °C
6.101 Mounting position	Vertical or horizontal

# Osmoz control and signalling units: non-illuminated heads



Technical characteristics p. 307 and e-catalogue

Supplied with a fixing ring  
 IP 66 except Cat.Nos 238 11/12/13 - IP 67  
 Conform to IEC 60947-5-1

Pack	Cat.Nos	Spring return
		<b>Flush</b>
10	0 238 00	○ White
10	0 238 01	● Red
10	0 238 02	● Green
10	0 238 03	● Blue
10	0 238 04	● Yellow
10	0 238 06	● Black
1	0 238 08	● Red engraved "O"
1	0 238 09	● Green engraved "I"
		<b>Flush with shroud</b>
5	0 238 11	● Red
5	0 238 12	● Green
5	0 238 13	● Black
		<b>Projecting Ø22</b>
5	0 238 21	● Red
1	0 238 22	● Green
5	0 238 26	● Black
		<b>Mushroom head Ø40</b>
10	0 238 34	● Red
10	0 238 35	● Green
10	0 238 36	● Black
1	0 238 37	● Yellow

Pack	Cat.Nos	Twin touch
5	0 239 80	Red engraved "O", green engraved "I"
5	0 239 82	Flush/Flush - Green/Red - IP 66 Flush/Projecting - Green/Red - IP 66

Pack	Cat.Nos	Stay-put mushroom heads
		<b>Push-pull emergency stop</b>
10	0 238 72	● Red - Ø40
1	0 238 76	● Black - Ø40
		<b>Push-pull EN 418 emergency stop</b>
10	0 238 74	● Red - Ø40
1	0 238 94	● Red - Ø54 With flag indicator "O - I"
5	0 238 95	● Red - Ø54 With flag indicator "STOP - I"
		<b>Push-turn emergency stop</b>
10	0 238 80	● Red - Ø32
1	0 238 81	● Black - Ø32
10	0 238 82	● Red - Ø40
1	0 238 83	● Black - Ø40
		<b>Push-turn EN 418 ISO 13850 emergency stop</b>
10	0 238 85	● Red - Ø40
		<b>Emergency stop with key</b>
10	0 238 91	● Red - Ø40
1	0 238 92	● Red - Ø40

Pack	Cat.Nos	Selector switches	Positions
		<b>With standard handle</b>	
1	0 239 01	● Red	2 stay-put positions - 45°
1	0 239 02	● Green	
10	0 239 03	● Black	
1	0 239 04	○ Grey	
1	0 239 09	● Black	2 positions with spring-return - 45°
10	0 239 15	● Black	2 stay-put positions - 90°
1	0 239 21	● Red	3 stay-put positions - 45°
1	0 239 22	● Green	
10	0 239 23	● Black	
1	0 239 24	○ Grey	
1	0 239 26	● Black	3 positions with spring-return from left to 0 - 45°
1	0 239 27	● Black	3 positions with spring-return from right to 0 - 45°
5	0 239 28	● Black	3 positions with spring-return to 0 - 45°
1	0 239 29	● Black	3 stay-put positions - 90°

Weatherproof cabinets, p. 242





## Osmoz control and signalling units: non-illuminated heads (continued)



## Osmoz control and signalling units: illuminated heads



0 239 32



0 239 51



0 240 02



0 240 12



0 240 73

Technical characteristics p. 307 and e-catalogue

Supplied with a fixing ring  
IP 66  
Conform to IEC 60947-5-1

Technical characteristics p. 307 and e-catalogue

Supplied with a fixing ring  
IP 66  
Conform to IEC 60947-5-1

Pack	Cat.Nos	Selector switches (continued)	
<b>With long handle</b>			
Black long handle			
10	0 239 30		2 stay-put positions - 45°
1	0 239 31		2 positions with spring-return - 45°
1	0 239 32		2 stay-put positions - 45°
1	0 239 34		2 stay-put positions - 90°
5	0 239 40		3 stay-put positions - 45°
1	0 239 43		3 positions with spring-return to 0 - 45°
<b>With key</b>			
Black button			
1	0 239 50		2 stay-put positions - 45°
1	0 239 51		2 stay-put positions - 45°
1	0 239 52		2 positions with spring-return - 45°
1	0 239 53		2 stay-put positions - 90°
1	0 239 54		2 stay-put positions - 90° Key free in both positions
1	0 239 60		3 stay-put positions - 45°
1	0 239 61		3 positions with spring-return to 0 - 45°
1	0 239 63		3 stay-put positions - 90° Key free in 3 positions

Pack	Cat.Nos	Spring return	
<b>Flush</b>			
10	0 240 00		White
10	0 240 01		Red
10	0 240 02		Green
1	0 240 03		Blue
5	0 240 04		Yellow
<b>Projecting</b>			
1	0 240 11		Red
1	0 240 12		Green
<b>Twin touch</b>			
<b>Flush/Projecting</b>			
Red engraved "O", green engraved "I"			
IP 66, become IP 67 with mounting accessory IP 67 shroud Cat.No 0 241 96			
5	0 240 73		Green/Red

For detailed dimensions, see e-catalogue



# Osmoz control and signalling units: illuminated heads (continued)



Technical characteristics p. 307 and e-catalogue

Supplied with fixing ring  
IP 66  
Conform to IEC 60947-5-1

Pack	Cat.Nos	Selector switches	Positions
<b>With standard handle</b>			
1	0 240 31	● Red	2 stay-put positions - 45°
5	0 240 32	● Green	
1	0 240 33	● Black	
1	0 240 35	● Red	2 stay-put positions - 45°
1	0 240 36	● Green	
1	0 240 37	● Black	
1	0 240 41	● Red	2 stay-put positions - 90°
5	0 240 42	● Green	
5	0 240 43	● Black	
1	0 240 51	● Red	3 stay-put positions - 45°
1	0 240 52	● Green	
1	0 240 53	● Black	
1	0 240 54	● Red	3 positions with spring-return from right to 0 - 45°
1	0 240 55	● Green	
1	0 240 56	● Black	
1	0 240 57	● Red	3 positions with spring-return to 0 - 45°
1	0 240 58	● Green	
1	0 240 59	● Black	
<b>With long handle IP 66</b>			
1	0 240 60	● Black	2 stay-put positions - 45°
1	0 240 61	● Black	3 stay-put positions - 45°

Pack	Cat.Nos	One-piece pilot lights
To be used without electrical block		
<b>With integrated Led</b>		
10	0 241 20	○ White - 24 V~/=
10	0 241 21	● Red - 24 V~/=
10	0 241 22	● Green - 24 V~/=
1	0 241 23	● Blue - 24 V~/=
10	0 241 24	● Yellow - 24 V~/=
1	0 241 30	○ White - 130 V~
1	0 241 31	● Red - 130 V~
1	0 241 32	● Green - 130 V~
1	0 241 33	● Blue - 130 V~
1	0 241 34	● Yellow - 130 V~
10	0 241 40	○ White - 230 V~
10	0 241 41	● Red - 230 V~
10	0 241 42	● Green - 230 V~
1	0 241 43	● Blue - 230 V~
10	0 241 44	● Yellow - 230 V~
<b>For BA9S lamp (not supplied)</b>		
Direct supply		
10	0 241 00	○ Colourless
10	0 241 01	● Red
10	0 241 02	● Green
1	0 241 03	● Blue
10	0 241 04	● Yellow
10	0 241 05	○ White

<b>Stay-put mushroom head</b>	
<b>Push-pull</b>	
1	0 240 80 ● Red - Emergency stop Ø40
5	0 240 82 ● Red - EN 418 emergency stop Ø40
<b>Push-turn</b>	
1	0 240 91 ● Red - Emergency stop Ø40
<b>Pilot lights</b>	
10	0 241 60 ○ White
10	0 241 61 ● Red
10	0 241 62 ● Green
5	0 241 63 ● Blue
5	0 241 64 ● Yellow

Weatherproof cabinets, p. 242



## Osmoz control and signalling units: block sub-assemblies



## Osmoz control and signalling units: electrical blocks



0 229 61



0 229 76



0 229 78



0 229 01



0 229 02



0 229 42



0 230 14



0 229 60



0 229 64



0 229 68

Technical characteristics p. 307 and e-catalogue

Clip and screw electrical blocks assembled  
Conform to IEC 60947-5-1

Pack	Cat.Nos	For non-illuminated heads
		<b>Screw terminals</b>
10	0 229 61	NC + 1 position clip
10	0 229 62	NO + 1 position clip
5	0 229 65	NO/NC + 3 position clip
5	0 229 66	2 x NO/NC + 3 position clip
1	0 229 71	NC + 3 position clip
1	0 229 72	NO + 3 position clip
10	0 229 73	2 NC + 3 position clip
10	0 229 74	2 NO + 3 position clip
10	0 229 76	NO + NC + 3 position clip
1	0 229 77	2 NO + NC + 3 position clip
1	0 229 78	NO + 2 NC + 3 position clip
		<b>For illuminated heads</b>
		<b>Screw terminals</b>
		With 3 position clip
1	0 229 80	White - 12-24 V~/= - 2 NO/NC
1	0 229 81	Red - 12-24 V~/= - 2 NO/NC
1	0 229 82	Green - 12-24 V~/= - 2 NO/NC
5	0 230 00	White - 12-24 V~/= - NO
5	0 230 01	Red - 12-24 V~/= - NO
5	0 230 02	Green - 12-24 V~/= - NO
1	0 230 03	White - 12-24 V~/= - NO + NC
1	0 230 04	Red - 12-24 V~/= - NO + NC
1	0 230 05	Green - 12-24 V~/= - NO + NC
5	0 230 06	White - 12-24 V~/= - 2 NO
5	0 230 07	Red - 12-24 V~/= - 2 NO
5	0 230 08	Green - 12-24 V~/= - 2 NO
1	0 229 90	White - 230 V~ - 2 NO/NC
1	0 229 91	Red - 230 V~ - 2 NO/NC
1	0 229 92	Green - 230 V~ - 2 NO/NC
5	0 230 10	White - 230 V~ - NO
5	0 230 11	Red - 230 V~ - NO
5	0 230 12	Green - 230 V~ - NO
1	0 230 13	White - 230 V~ - NO + NC
1	0 230 14	Red - 230 V~ - NO + NC
1	0 230 15	Green - 230 V~ - NO + NC
5	0 230 16	White - 230 V~ - 2 NO
5	0 230 17	Red - 230 V~ - 2 NO
5	0 230 18	Green - 230 V~ - 2 NO

Technical characteristics p. 307 and e-catalogue

IP 20  
Conform to IEC 60947-5-1

Pack	Cat.Nos	For non-illuminated heads
		Contact blocks
		<b>Screw terminals</b>
20	0 229 01	NC
20	0 229 02	NO
10	0 229 03	NO/NC
		<b>For illuminated heads</b>
		<b>Screw terminals</b>
5	0 229 10	White - 12-24 V~/=
5	0 229 11	Red - 12-24 V~/=
5	0 229 12	Green - 12-24 V~/=
5	0 229 13	Blue - 12-24 V~/=
5	0 229 14	Yellow - 12-24 V~/=
1	0 229 20	White - 48 V~/=
1	0 229 21	Red - 48 V~/=
1	0 229 22	Green - 48 V~/=
1	0 229 23	Blue - 48 V~/=
1	0 229 24	Yellow - 48 V~/=
5	0 229 40	White - 230 V~
5	0 229 41	Red - 230 V~
5	0 229 42	Green - 230 V~
5	0 229 43	Blue - 230 V~
5	0 229 44	Yellow - 230 V~
		<b>Clips</b>
		Mounting (p. 307)
20	0 229 60	1 position
20	0 229 64	3 positions
10	0 229 68	5 positions

For detailed dimensions,  
see e-catalogue



## Osmoz control and signalling units control stations to be equipped



## Osmoz control and signalling units accessories



### Technical characteristics p. 307 and e-catalogue

Empty control stations to be equipped with:  
- illuminated or non-illuminated heads (p. 302 to 304)  
- specific blocks for control stations

Pack	Cat.Nos	Control stations (to be equipped) IP 66 - IK 07
1	0 242 00	Possibility to mount 3 electrical blocks per hole
1	0 242 01	1 hole - grey
1	0 242 02	1 hole - yellow cover
1	0 242 02	2 holes - grey
1	0 242 03	3 holes - grey
1	0 242 04	4 holes - grey
1	0 242 05	5 holes - grey

Pack	Cat.Nos	Specific blocks
		Contact block mounted on control station base
		<b>Screw terminals</b>
10	0 242 41	NC
10	0 242 42	NO
		<b>Illuminated LED blocks</b>
1	0 242 50	○ White - 12-24 V~/=
1	0 242 51	● Red - 12-24 V~/=
1	0 242 52	● Green - 12-24 V~/=
1	0 242 53	● Blue - 12-24 V~/=
1	0 242 54	● Yellow - 12-24 V~/=
1	0 242 70	○ White - 230 V~
1	0 242 71	● Red - 230 V~
1	0 242 72	● Green - 230 V~
1	0 242 74	● Blue - 230 V~
1	0 242 73	● Yellow - 230 V~

Pack	Cat.Nos	BA9S bulbs
10	0 241 71	For one-piece pilot lights ● Red - neon - 230 V~
		<b>Mounting accessories</b>
		<b>IP 67 shroud</b>
		Reinforced degree of protection: IP 67 For spring return buttons
5	0 241 90	○ Transparent
5	0 241 91	● Red
5	0 241 92	● Green
5	0 241 93	● Black
1	0 241 96	○ Transparent for twin touch flush/projecting
1	0 241 81	Yellow - standard padlockable guard for mushroom head
		<b>Pre-drilled supports</b>
10	0 044 05	Clip-on to DIN rail  Pre-drilled support for mounting 150 x Ø22.5 control and signalling units
1	0 248 45	Double pre-drilled support 300 x Ø22.5 control and signalling units
		<b>Miscellaneous</b>
1	0 241 88	Padlockable shroud
10	0 241 87	Blanking plug - black
1	0 241 73	Bulb extractor
1	0 241 85	Fixing tool
		<b>Legend plates</b>
		To mount on frame
		<b>Without engraving</b>
10	0 243 02	○ Alu - standard model
10	0 243 03	● Black - standard model
10	0 243 07	○ Alu - large model
10	0 243 08	● Black - large model
		<b>With engraving</b>
		○ Alu - standard model
10	0 243 30	"O I"
10	0 243 32	"I O II"
10	0 243 43	"MANU - AUTO"
10	0 243 44	"MANU - O - AUTO"
10	0 243 51	"START"
		<b>Round legend plate for mushroom head</b>
10	0 241 76	● Yellow Ø60 "EMERGENCY STOP"
10	0 241 79	Ø80 "EMERGENCY STOP"
		<b>Frames</b>
		Supplied without legend plate
		<b>Without engraving</b>
10	0 243 15	Round - standard model
10	0 243 16	Round - large model
10	0 243 18	Square - standard model
10	0 243 19	Round - standard model for twin touch

# Osmoz control and signalling units

## Mounting

### Non illuminated

Head with 1 contact block on 1 position clip

Head with 1 or 2 contact blocks on a 3 position clip

Head with 3 contact blocks on a 3 position clip

Head with 4 or 5 contact blocks on a 5 position clip

Head with 4, 5 or 6 contact blocks 2<sup>nd</sup> level of contact blocks stacked directly on first row (3 position clip)

### Illuminated

Pilot light on 1 position clip

Illuminated head with LED and 1 or 2 contact blocks on 3-position clip

Illuminated head with LED and 3 or 4 contact blocks 2<sup>nd</sup> level of contact blocks stacked directly on first row (3 position clip)

Illuminated head with LED on transformer supply with 1 or 2 contact blocks on 3 position clip

Illuminated head with LED and 3 or 4 contact blocks on 5 position clip

Illuminated blocks

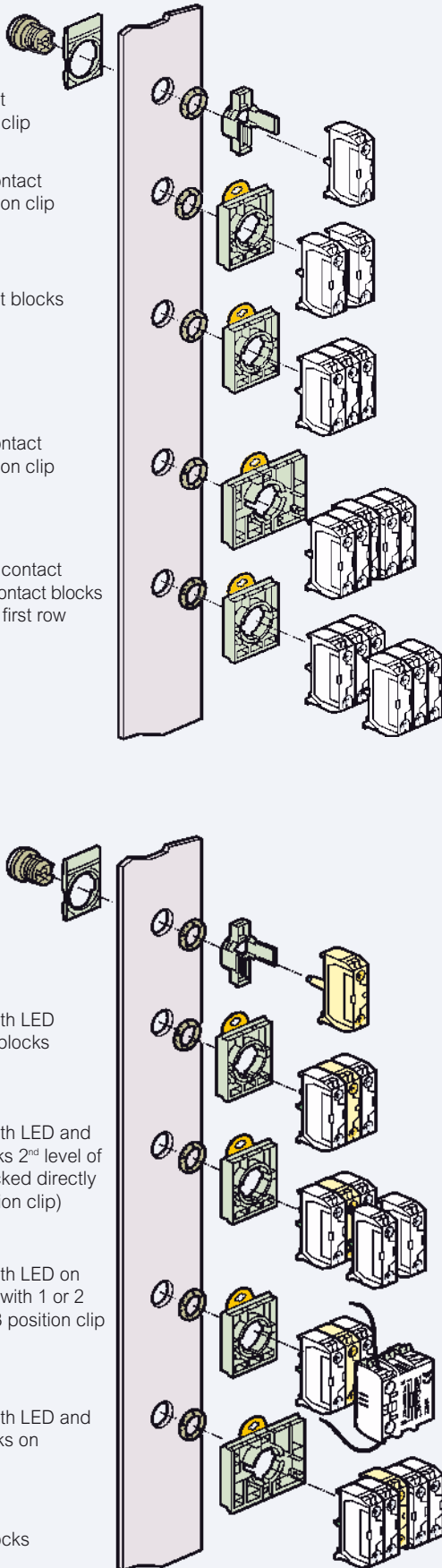

## Technical characteristics

- Climatic resistance:
    - conform to IEC 60068-2-3 (constant humid heat)
    - conform to IEC 60068-2-30 (cyclical damp heat)
  - Degree of protection conform to IEC 60529
    - IP 66 for standard heads
    - IP 67 for shrouded heads
    - IP 66 for equipped control stations
    - IP 20 at the rear of the panel for contact blocks and one piece pilot lights
    - Nema 4x, 12 and 13 for heads and control stations
  - Protection against mechanical shocks conform to IEC 50102:
    - IK 05 illuminated and non illuminated heads
    - IK 07 empty control station
  - Protection against electrical shocks:
    - Class II according to IEC 60947-5-1
  - Tightening torque: head nut: recommended 3 N.m  
terminals: max. 1.2 N.m
- cULus and Bureau Veritas approvals

### Contact blocks (for non illuminated heads)

- Rated insulation voltage:
  - Degree of pollution 3
  - 690 V according to IEC/EN60947 for flush block with screw terminals or spring terminals
  - 600 V AC according to UL 508
- NC contacts:
  - Positive opening conform to IEC/EN 60947-5-1
- Rated impulse withstand voltage Uimp: 6kV contact blocks
- Convention thermal conform to IEC 60947-5-1 current in free air conditions:
  - AC: 10 A
  - DC: 2.5 A
- Electrical performance:
 

- AC according to IEC 60947-5-1	- DC according to IEC 60947-5-1
AC15 - A 600	DC13 - Q 600
Ue = 120 V, Ie = 6 A	Ue = 125 V, Ie = 0.55 A
Ue = 240 V, Ie = 3 A	Ue = 250 V, Ie = 0.27 A
Ue = 380 V, Ie = 1.9 A	Ue = 400 V, Ie = 0.15 A
Ue = 480 V, Ie = 1.5 A	Ue = 500 V, Ie = 0.13 A
Ue = 500 V, Ie = 1.4 A	Ue = 500 V, Ie = 0.1 A
Ue = 500 V, Ie = 1.2 A	
- Electrical durability
  - 1 million cycles for:
    - AC15 - B 300
      - Ue = 120 V, Ie = 3 A
      - Ue = 240 V, Ie = 1.5 A
    - DC13 - R 300
      - Ue = 125 V, Ie = 0.22 A
      - Ue = 250 V, Ie = 0.1 A
- Connection capacity (rigid or flexible wire)
  - without ferrule: 2 x 0.5 mm<sup>2</sup> to 2 x 2.5 mm<sup>2</sup>
  - with ferrule: 2 x 0.5 mm<sup>2</sup> to 2 x 1.5 mm<sup>2</sup>

### LED blocks and LED pilot lights (for illuminated heads)

- Rated insulation voltage:
  - Degree of pollution 3
  - 300 V according to IEC/EN60947-5-1
- Rated insulation withstand voltage Uimp:
  - 4kV conform to IEC/EN 60947-1
- Operating voltage:
 

12 to 24 V AC/DC	} ± 10 %
130 V AC	
230 V AC	
- Frequency: 50 or 60 Hz
- Lifetime at rated supply voltage:
  - Red and yellow: 100,000 hours at 25°C
  - Other colours: 50,000 hours at 25°C
- Consumption of LED blocks:
  - Voltage:
    - 24 V: 25 mA ± 20%
    - 48 V: 15 mA ± 10%
    - 130 V: 20 mA ± 10%
    - 230 V: 16 mA ± 30%

# Cam switches insulating box



0 277 11



0 277 46



0 277 76

Technical characteristics p. 309 and e-catalogue

For selecting and changing the status of the circuits into which it is integrated  
 For viewing the state of equipment according to the position of the selector lever  
 Boxed device, class II. Contacts with positive opening and double breaking of poles  
 Presentation: black or grey/black selector lever, faceplate with marking  
 Conform to standards IEC EN 60947-3  
 IP 65 for 76 x 76 and 96 x 120 mm boxes. IP 55 for 135 x 170 mm boxes

Pack	Cat.Nos	Function: on/off switch				
<b>76 x 76 mm box</b>						
		Number of poles	Range	Max. rating AC 21 (A)	Position	Number of contacts
1	0 277 10	1	PR 12	16		1
1	0 277 11	2	PR 12	16		2
1	0 277 12	3	PR 12	16		3
1	0 277 13	4	PR 12	16		4
<b>96 x 120 mm box</b>						
		Number of poles	Range	Max. rating AC 21 (A)	Position	Number of contacts
1	0 277 16	2	PR 17	20		2
1	0 277 17	3	PR 17	20		3
1	0 277 18	4	PR 17	20		4
1	0 277 21	2	PR 21	25		2
1	0 277 22	3	PR 21	25	3	
1	0 277 23	4	PR 21	25	4	

Function: changeover switches						
<b>Without off - 96 x 120 mm box</b>						
		Number of poles	Range	Max. rating AC 21 (A)	Position	Number of contacts
1	0 277 55	3	PR 12	16		6
1	0 277 56	4	PR 12	16		8
1	0 277 58	4	PR 17	20		8
1	0 277 60	4	PR 21	25		8
1	0 277 62	4	PR 26	32		8
<b>Without off - 135 x 170 mm box</b>						
1	0 277 64	4	PR 40	50		8
1	0 277 66	4	PR 63	63		8

<b>With off - 96 x 120 mm box</b>						
		Number of poles	Range	Max. rating AC 21 (A)	Position	Number of contacts
1	0 277 25	1	PR 12	16		2
1	0 277 26	2	PR 12	16		4
1	0 277 27	3	PR 12	16		6
1	0 277 28	4	PR 12	16		8
1	0 277 31	2	PR 17	20		4
1	0 277 32	3	PR 17	20		6
1	0 277 33	4	PR 17	20		8
1	0 277 36	2	PR 21	25		4
1	0 277 37	3	PR 21	25		6
1	0 277 38	4	PR 21	25		8
1	0 277 41	2	PR 26	32		4
1	0 277 42	3	PR 26	32		6
1	0 277 43	4	PR 26	32		8

Pack	Cat.Nos	Function: changeover switch (continued)				
<b>With off - 135 x 170 mm box</b>						
		Number of poles	Range	Max. rating AC 21 (A)	Position	Number of contacts
1	0 277 46	2	PR 40	50		4
1	0 277 47	3	PR 40	50		6
1	0 277 48	4	PR 40	50		8
1	0 277 51	2	PR 63	63		4
1	0 277 52	3	PR 63	63		6
1	0 277 53	4	PR 63	63		8

Function: 3-way switches						
<b>With off - 76 x 76 mm box</b>						
		Number of poles	Range	Max. rating AC 21 (A)	Position	Number of contacts
1	0 277 67	1	PR 12	16		3
<b>With off - 96 x 120 mm box</b>						
1	0 277 68	1	PR 12	16		3
1	0 277 69	2	PR 12	16		6

Function: 3-phase motor switch						
<b>Forward/reverse switch, 1 speed</b>						
		Range	Max. rating AC 3 (kW)	Position	Number of contacts	
1	0 277 70	PR 12	4		5	
1	0 277 75	PR 17	7.5		5	
1	0 277 78	PR 21	7.5		5	
1	0 277 81	PR 26	11		5	
1	0 277 84	PR 40	18.5		5	

<b>Starter 1 way, 1 speed</b>						
		Range	Max. rating AC 3 (kW)	Position	Number of contacts	
1	0 277 71	PR 12	4		8	
1	0 277 76	PR 17	7.5		8	
1	0 277 79	PR 21	7.5		8	
1	0 277 82	PR 26	11		8	
1	0 277 85	PR 40	18.5		8	

<b>Starter 1 way, 2 speed Dalhander</b>						
		Range	Max. rating AC 3 (kW)	Position	Number of contacts	
1	0 277 72	PR 12	4		8	
1	0 277 77	PR 17	7.5		8	
1	0 277 80	PR 21	7.5		8	
1	0 277 83	PR 26	11		8	
1	0 277 73	PR 12	4			8

# Cam switches

## Electrical characteristics

		PR 12	PR 17	PR 21	PR 26	PR 40	PR 63
<b>Thermal rating</b>		20 A	25 A	32 A	40 A	63 A	63 A
<b>Rated operating current (Ie) AC 21</b>		16 A	20 A	25 A	32 A	50 A	63 A
<b>Rated operating current (Ie) AC 15</b>		6 A	8 A	10 A	12 A	-	-
<b>Motor performance AC 23</b>	<b>3 x 230 V</b>	4 kW	5.5 kW	7.5 kW	11 kW	15 kW	18.5 kW
	<b>3 x 400 V</b>	7.5 kW	11 kW	11 kW	11 kW	22 kW	25 kW
	<b>3 x 500 V</b>	5.5 kW	11 kW	11 kW	11 kW	25 kW	25 kW
	<b>3 x 690 V</b>	4 kW	10 kW	10 kW	11 kW	18.5 kW	22 kW
<b>Motor performance AC 3</b>	<b>3 x 230 V</b>	3 kW	4 kW	4 kW	5.5 kW	11 kW	15 kW
	<b>3 x 400 V</b>	4 kW	7.5 kW	7.5 kW	11 kW	18.5 kW	22 kW
	<b>3 x 500 V</b>	5.5 kW	7.5 kW	7.5 kW	11 kW	18.5 kW	22 kW
	<b>3 x 690 V</b>	3 kW	7.5 kW	7.5 kW	11 kW	18.5 kW	22 kW
<b>Degree of protection</b>	<b>front</b>	IP 40	IP 40	IP 40	IP 40	IP 40	IP 40
	<b>back</b>	IP 2X	IP 2X	IP 2X	IP 2X	-	-
<b>Insulation voltage (Ui)</b>		690 V	690 V	690 V	690 V	690 V	690 V
<b>Max. cable cross-section</b>	<b>flexible</b>	2.5 mm <sup>2</sup>	4 mm <sup>2</sup>	4 mm <sup>2</sup>	6 mm <sup>2</sup>	16 mm <sup>2</sup>	16 mm <sup>2</sup>
	<b>rigid</b>	4 mm <sup>2</sup>	6 mm <sup>2</sup>	6 mm <sup>2</sup>	6 mm <sup>2</sup>	16 mm <sup>2</sup>	16 mm <sup>2</sup>

## Drilling

For PR 12 - 76 x 76 mm box  
2 x 2 knock-out entries PG 16

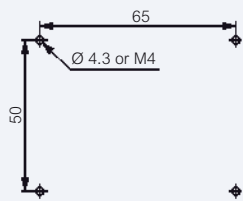

For PR 12, PR 17, PR 21 and PR 26 - 96 x 120 mm box  
2 x 2 knock-out entries PG 16

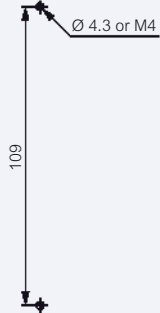

For PR 40 and PR 63 - 135 x 170 mm box  
6 knock-out entries PG 21  
+ 4 knock-out entries PG 29



## Dimensions

For PR 12 (1 to 4 contacts)

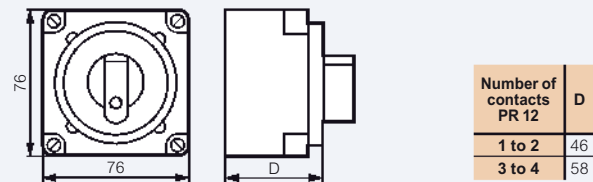

For PR 12 (1 to 9 contacts)  
PR 17 and 21 (1 to 9 contacts)  
PR 26 (1 to 8 contacts)

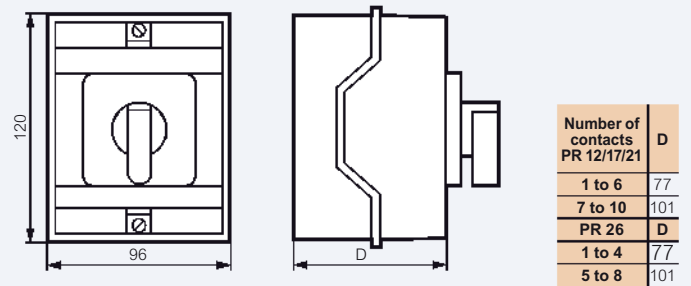

For PR 40/63 (1 to 8 contacts)

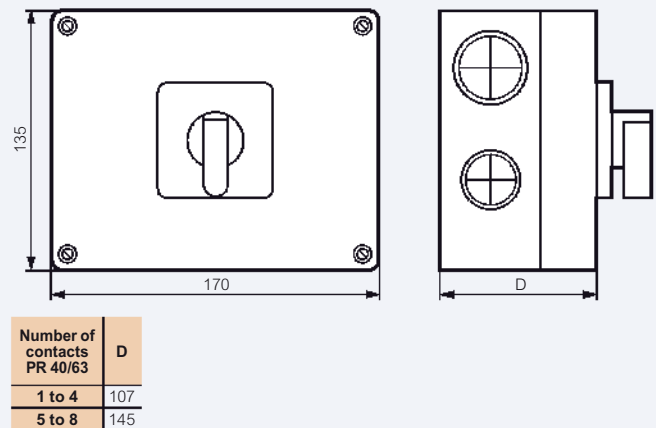

# Cam switches (continued)

## Diagram - Terminals

### On/off switch

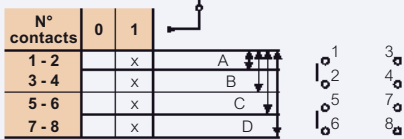

	PR 12	PR 17	PR 21
A	0 277 10	-	-
B	0 277 11	0 277 16	0 277 21
C	0 277 12	0 277 17	0 277 22
D	0 277 13	0 277 18	0 277 23

### Changeover switch

#### •Without "off"

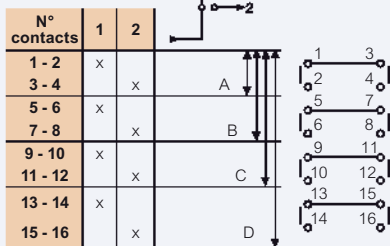

	PR 12	PR 17	PR 21	PR 26	PR 40	PR 63
C	0 277 55	-	-	-	-	-
D	0 277 56	0 277 58	0 277 60	0 277 62	0 277 64	0 277 66

#### •With "off"

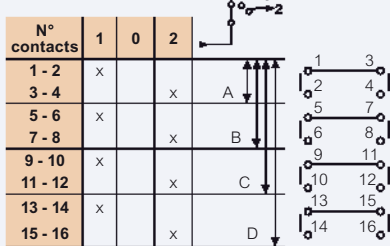

	PR 12	PR 17	PR 21	PR 26	PR 40	PR 63
A	0 277 25	-	-	-	-	-
B	0 277 26	0 277 31	0 277 36	0 277 41	0 277 46	0 277 51
C	0 277 27	0 277 32	0 277 37	0 277 42	0 277 47	0 277 52
D	0 277 28	0 277 33	0 277 38	0 277 43	0 277 48	0 277 53

### 3-way switch

#### •With "off"

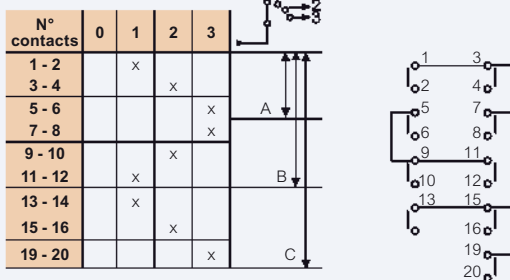

	PR 12
A	0 277 67/68
B	0 277 69

## Diagram - terminals (continued)

### 3-phase motor switch

#### •Forward/reverse switch 1 speed

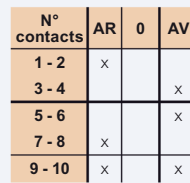

	PR 12	PR 17	PR 21	PR 26	PR 40	PR 63
Boxes	0 277 70	0 277 75	0 277 78	0 277 81	0 277 84	-

#### •Starter 1 way - 1 speed

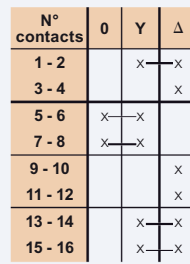

	PR 12	PR 17	PR 21	PR 26	PR 40	PR 63
Boxes	0 277 71	0 277 76	0 277 79	0 277 82	0 277 85	-

#### •Starter 1 way - 2 speed Dahlander 2 possible configurations: 0 - PV - GV PV - 0 - GV

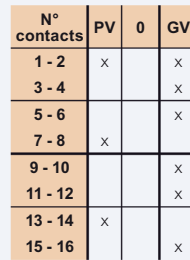

	PR 12	PR 17	PR 21	PR 26	PR 40
Boxes					
0 - PV - GV	0 277 72	0 277 77	0 277 80	0 277 83	-
PV - 0 - GV	0 277 73	-	-	-	-

### Selective measurement switches

#### •Ammeter 3 C.T. with common point

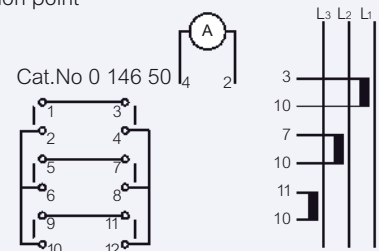
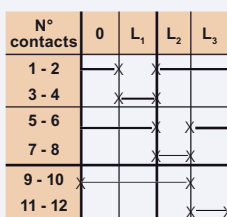



## Cam switches screw fixing on door

### Selective measurement switches (continued)

•Ammeter without C.T.

N° contacts	0	L <sub>1</sub>	L <sub>2</sub>	L <sub>3</sub>
1 - 2	X	X		
3 - 4	X	X		
5 - 6	X	X		
7 - 8		X	X	
9 - 10		X	X	
11 - 12		X	X	
13 - 14	X			X
15 - 16				X
17 - 18				X

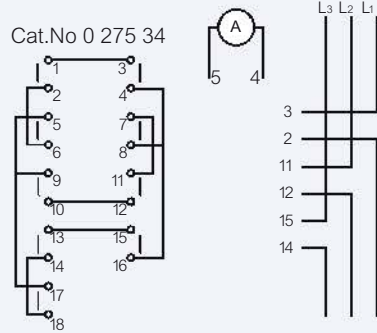

0 275 35

•Ammeter with 3 independent C.T.

N° contacts	0	L <sub>1</sub>	L <sub>2</sub>	L <sub>3</sub>
1 - 2	X	X		
3 - 4	X	X		
5 - 6	X	X		
7 - 8		X	X	
9 - 10		X	X	
11 - 12		X	X	
13 - 14				X
15 - 16				X
19 - 20				X

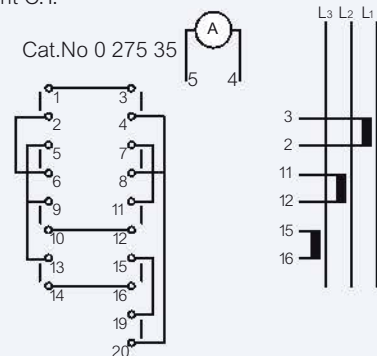

•Voltmeter without neutral

N° contacts	0	L <sub>1</sub>	L <sub>2</sub>	L <sub>3</sub>
1 - 2		x		x
3 - 4			x	
5 - 6		x	x	
7 - 8				x

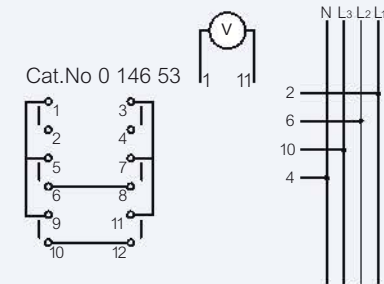

•Voltmeter with neutral

N° contacts	L <sub>3</sub>	L <sub>2</sub>	L <sub>1</sub>	0	L <sub>1</sub>	L <sub>2</sub>	L <sub>3</sub>
1 - 2	x		x		x		x
3 - 4		x			x		x
5 - 6		x				x	
7 - 8			x				x
9 - 10							x
11 - 12	x	x					

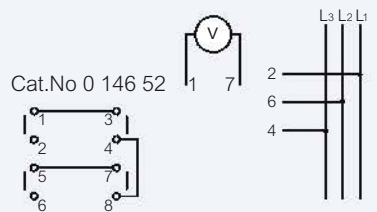

### Dimensions

PR 12

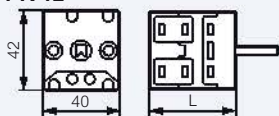

Number of contacts	L Screw fixing
3 to 4	46
5 to 6	56
9 to 10	76

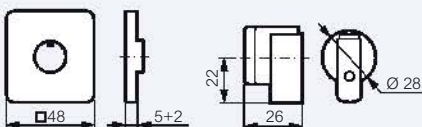

For selecting and changing the status of the circuits into which it is integrated  
For viewing the state of equipment according to the position of the selector lever

Mounting on enclosure doors

Contacts with positive opening and double breaking of poles

Presentation: grey/black selector lever - aluminium faceplate with marking

Conform to standards IEC EN 60947-3

Approved to UL-CSA (USA - Canada)

IP 40 at front of enclosure (selector lever)

IP 2X at back of enclosure up to PR 26

Pack	Cat.Nos	Function: selective measurement switches				
		<b>Ammeters</b>				
		1 network, 3-wire, 1 ammeter				
		Range	Max. rating AC 21 (A)	Position	Number of contacts	Function
1	0 146 50	PR 12	16		6	3 C.T. with common point without C.T.
1	0 275 34	PR 12	16		9	3 independent C.T.
1	0 275 35	PR 12	16			
		<b>Voltmeters</b>				
		3-phase network, 1 voltmeter				
		Range	Max. rating AC 21 (A)	Position	Number of contacts	Function
1	0 146 52	PR 12	16		4	without neutral
1	0 146 53	PR 12	16		6	with neutral

# Control, safety and circuit isolation transformers

single-phase



0 442 14



0 442 68



0 442 71

Technical characteristics p. 315  
Protection p. 320

IP 2X or XXB up to 400 VA - IP XXA over 400 VA - IK 04  
Conform to IEC EN 61558-2-2 and 2-4 or 2-6, UL506 and CSA C22-2-No 66  
UL USA and Canada agreements. Products suitable for building equipment conforming to standards EN 61131-2, EN 60204-1 and EN 60439-1  
Active parts protected by cover up to 1000 VA. Interference filtering (except Cat.Nos 0 442 16/17/18)  
Direct fixing possibility on symmetrical rail up to 250 VA. Supplied with connection strip 0 V secondary / earth up to 1000 VA (except spring connection range)

## Pack Cat.Nos Control and safety - screw connection

Pack	Cat.Nos	Power in VA			Instantaneous admissible power at cos φ = 0.5	Diagram
		according to IEC and CSA	according to UL	according to IEC and CSA		
<b>Input voltage = 230 V ± 15 V</b>						
<b>Output voltage = 24 V</b>						
1	0 442 11	40	40	50		
1	0 442 12	63	63	88		
1	0 442 13	100	100	170		
1	0 442 14	160	140	250		
1	0 442 15	250	210	420		
1	0 442 16	400	300	850		
1	0 442 17	630	500	1500		
1	0 442 18	1000	700	2000		
<b>Input voltage = 460 V ± 20 V</b>						
<b>Output voltage = 24 V</b>						
1	0 442 41	40	40	55		
1	0 442 42	63	63	90		
1	0 442 43	100	100	150		
1	0 442 44	160	140	270		
1	0 442 45	250	210	420		
1	0 442 46	400	300	980		
1	0 442 47	630	450	1000		
1	0 442 48	1000	700	2000		
1	0 442 49	1600	700	9100		
1	0 442 50	2500	1400	3300		
<b>Input voltage = 230-400 V ± 15 V</b>						
<b>Output voltage = 24-48 V</b>						
Supplied with 2 coupling strips						
1	0 442 31	40	40	52		
1	0 442 32	63	63	87		
1	0 442 33	100	100	150		
1	0 442 34	160	140	250		
1	0 442 35	250	210	420		
1	0 442 36	400	300	700		
1	0 442 37	630	500	1700		
1	0 442 38	1000	700	2000		
1	0 442 39	1600	700	8500		
1	0 442 40	2500	1400	3300		

## Pack Cat.Nos Control and circuit isolation- screw connection

Pack	Cat.Nos	Power in VA			Instantaneous admissible power at cos φ = 0.5	Diagram
		according to IEC and CSA	according to UL	according to IEC and CSA		
<b>Input voltage = 230-400 V ± 15 V</b>						
<b>Output voltage = 115-230 V</b>						
Supplied with 2 coupling strips						
1	0 442 61	40	40	50		
1	0 442 62	63	63	86		
1	0 442 63	100	100	150		
1	0 442 64	160	140	250		
1	0 442 65	250	210	430		
1	0 442 66	400	300	1100		
1	0 442 67	630	500	1600		
1	0 442 68	1000	700	2000		
1	0 442 69	1600	700	6100		
1	0 442 70	2500	1300	7100		
1	0 442 71	4000	2400	11400		
1	0 442 72	5000	3300	17500		
1	0 442 73	6300	3700	16000		
1	0 442 74	8000	4500	32100		
<b>Input voltage = 460 V ± 20 V</b>						
<b>Output voltage = 115-230 V</b>						
Supplied with 2 coupling strips						
1	0 442 81	40	40	50		
1	0 442 82	63	63	86		
1	0 442 83	100	100	150		
1	0 442 84	160	140	250		
1	0 442 85	250	210	430		
1	0 442 86	400	300	1100		
1	0 442 87	630	500	1600		
1	0 442 88	1000	700	2000		
1	0 442 89	1600	700	6100		
1	0 442 90	2500	1300	7100		
1	0 442 91	4000	2400	11400		

## Pack Cat.Nos Control and safety - spring connection

Pack	Cat.Nos	Power in VA			Instantaneous admissible power at cos φ = 0.5	Diagram
		according to IEC and CSA	according to UL	according to IEC and CSA		
<b>Input voltage = 230-400 V ± 15 V</b>						
<b>Output voltage = 24 V</b>						
1	0 442 01	40	40	50		
1	0 442 02	63	63	88		
1	0 442 03	100	100	170		
1	0 442 04	160	140	250		
1	0 442 05	250	210	420		
1	0 442 06	400	300	850		

## Pack Cat.Nos Control and circuit isolation - spring connection

Pack	Cat.Nos	Power in VA			Instantaneous admissible power at cos φ = 0.5	Diagram
		according to IEC and CSA	according to UL	according to IEC and CSA		
<b>Input voltage = 230 V ± 15 V</b>						
<b>Output voltage = 230 V</b>						
1	0 442 51	40	40	50		
1	0 442 52	63	63	86		
1	0 442 53	100	100	150		
1	0 442 54	160	140	250		
1	0 442 55	250	210	360		
1	0 442 56	400	300	1100		

# Equipment transformers

single-phase



0 428 40 +  
0 428 99



connection strip  
supplied up to 450 VA  
(except Cat.No 0 428 46)



0 428 41 supplied with connection strip



0 427 92

IP 2X or XXB up to 450 VA (up to 310 VA in 12-24 V) - IK 04

Clip on fixing possibility up to 160 VA with accessories Cat.No 0 044 16 or 0 428 99

Transformers with 2 secondary voltage supplied with coupling strip

Transformers up to 450 VA supplied with isolated strip for 0 V connection secondary / earth (except Cat.No 0 428 46)

Conform to IEC EN 61558-2-6 for 12 V, 24 V and 48 V and conform to IEC EN 61558-2-4 for 115 V and 230 V

Products suitable for building equipment conforming to standards EN 61131-2, EN 60204-1 and EN 61 439-1

Pack	Cat.Nos	Safety		
		<b>Input voltage = 230-400 V</b>		
		<b>Output voltage = 12-24 V</b>		
		Power (VA)	Primary terminal flexible cable (mm <sup>2</sup> )	Secondary terminal flexible cable (mm <sup>2</sup> )
1	0 428 40	40	1 to 4	1 to 4
1	0 428 41	63	1 to 4	1 to 4
1	0 428 42	100	1 to 4	1 to 4
1	0 428 43	160	1 to 4	1 to 4
1	0 428 44	220	1 to 4	1 to 4
1	0 428 45	310	1 to 4	1 to 4
1	0 428 46	450	1 to 4	1 to 16
1	0 428 47	630	1 to 4	1 to 16
1	0 428 49	1000	0.25 to 6	4 to 35
		<b>Input voltage = 230-400 V</b>		
		<b>Output voltage = 24 V</b>		
1	0 428 55	40	1 to 4	1 to 4
1	0 428 56	63	1 to 4	1 to 4
1	0 428 57	100	1 to 4	1 to 4
1	0 428 58	160	1 to 4	1 to 4
1	0 428 59	220	1 to 4	1 to 4
1	0 428 60	310	1 to 4	1 to 4
1	0 428 61	450	1 to 4	1 to 4
1	0 428 62	630	1 to 4	1 to 16
		<b>Input voltage = 230-400 V</b>		
		<b>Output voltage = 24-48 V</b>		
1	0 428 70	40	1 to 4	1 to 4
1	0 428 71	63	1 to 4	1 to 4
1	0 428 72	100	1 to 4	1 to 4
1	0 428 73	160	1 to 4	1 to 4
1	0 428 74	220	1 to 4	1 to 4
1	0 428 75	310	1 to 4	1 to 4
1	0 428 76	450	1 to 4	1 to 4
1	0 428 77	630	1 to 4	1 to 16

Pack	Cat.Nos	Circuits isolation		
		<b>Input voltage = 230-400 V</b>		
		<b>Output voltage = 115-230 V</b>		
		Power (VA)	Primary terminal flexible cable (mm <sup>2</sup> )	Secondary terminal flexible cable (mm <sup>2</sup> )
1	0 427 85	40	1 to 4	1 to 4
1	0 427 86	63	1 to 4	1 to 4
1	0 427 87	100	1 to 4	1 to 4
1	0 427 88	160	1 to 4	1 to 4
1	0 427 89	220	1 to 4	1 to 4
1	0 427 90	310	1 to 4	1 to 4
1	0 427 91	450	1 to 4	1 to 4
1	0 427 92	630	1 to 4	1 to 4

Pack	Cat.Nos	Accessories
		For clip on rail (90° mounting) of transformers up to 160 VA with 2 claws
5	0 428 99	Plate
10	0 044 16	Claw width 10 mm
		Threaded hole
		For M4 screw

Isolating transformers for hospitals (IEC 61558-2-15), p. 823





0 427 23

0 425 14

0 422 82

Technical characteristics **p. 318**  
 Protection devices **p. 320**

Pack	Cat.Nos	Safety transformers		
		Conform to standard IEC EN 61558-2-6 For 63 VA transformers: • Fuse cartridges: 5 x 20 time-delayed • Fuse carrier: Cat.No 0 371 81 For 100 VA and greater transformers: • Up to 25 A : gG 10 x 38 fuse cartridges and fuse carrier Cat. No. 0 058 08 • From 25 A to 50 A : gG 14 x 51 fuse cartridges and fuse carrier Cat.No 0 215 01 • From 50 A upwards : gG 22 x 58 fuse cartridges and fuse carrier Cat.No 0 216 01 • C curve MCBs		
		<b>Input voltage = 230-400 V</b> <b>Output voltage = 24-48 V</b>		
			Primary terminal flexible cable (mm <sup>2</sup> )	Secondary terminal flexible cable cross-section (mm <sup>2</sup> )
1	0 427 20	63	4	4
1	0 427 21	100	4	4
1	0 427 22	160	4	4
1	0 427 23	250	4	4
1	0 427 24	400	4	16
1	0 427 25	630	4	16
1	0 427 26	1000	4	16
		<b>Input voltage = 230 V</b> <b>Output voltage = 12 V</b>		
1	0 427 60	63	4	4
1	0 427 61	100	4	4
1	0 427 62	160	4	4
1	0 427 63	250	4	4
1	0 427 64	400	4	16
1	0 427 65	630	4	16



Pack	Cat.Nos	Circuit isolation transformers		
		Conform to standard IEC EN 61558-2-4 <b>Input voltage = 230-400 V</b> <b>Output voltage = 115-230 V</b>		
			Primary terminal flexible cable (mm <sup>2</sup> )	Secondary terminal flexible cable cross-section (mm <sup>2</sup> )
1	0 425 10	63	4	4
1	0 425 11	100	4	4
1	0 425 12	160	4	4
1	0 425 13	250	4	4
1	0 425 14	400	4	16
1	0 425 15	630	4	16
1	0 425 16	1000	4	16



Pack	Cat.Nos	Auto-transformers		
		<b>Single phase - protected</b> 400-230 V or 230-400 V by reversibility Conform to standard IEC 61558-2-13		
			Terminal	
			primary flexible cable (mm <sup>2</sup> )	secondary flexible cable (mm <sup>2</sup> )
		Power (kVA)		
1	0 422 82	0.25	4	4
1	0 422 84	0.5	4	4
1	0 422 85	0.75	4	4
1	0 422 86	1	4	4
1	0 422 87	1.5	16	16
1	0 422 88	2	16	16



# Control, safety and circuit isolation transformers

single-phase

## ■ Dimensions

Fig. 1: 40 to 400 VA

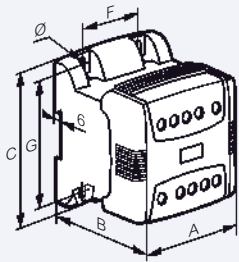

Fig. 2: 630-1000 VA

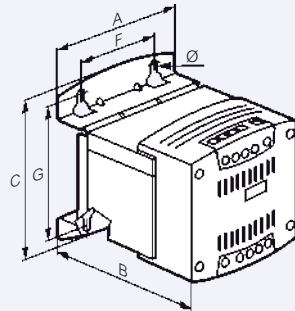

Fig. 3: 1600-2500 VA

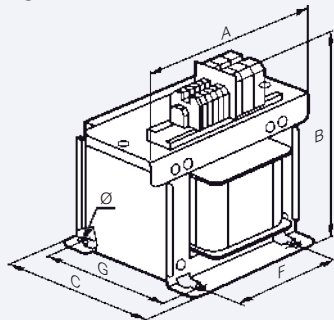
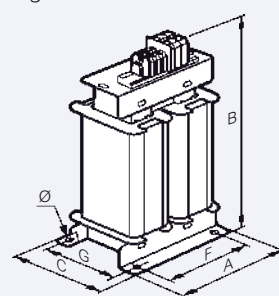

Fig. 4: 4000 to 8000 VA



Cat. Nos	Power (VA)	Fig.	Dimensions (mm)				Fixing <sup>(1)</sup>			Weight (Kg)
			A	B	C	F	G	Ø		
0 442 01/51	40	1	95	94	113	50	100	5.2	1.45	
0 442 02/52	63	1	95	101	113	50	100	5.2	1.75	
0 442 03/53	100	1	95	111	113	50	100	5.2	2.15	
0 442 04/54	160	1	95	128	113	50	100	5.2	2.35	
0 442 05/55	250	1	107	139	115	50	100	5.2	4	
0 442 06/56	400	1	121	156	140	62.5	125	5.2	5.8	
0 442 11/31/41/61/81	40	1	94	78	113	50	100	5.2	1.23	
0 442 12/32/42/62/82	63	1	94	85	113	50	100	5.2	1.56	
0 442 13/33/43/63/83	100	1	94	94	113	50	100	5.2	1.95	
0 442 14/34/44/64/84	160	1	94	112	113	50	100	5.2	2.6	
0 442 15/35/45/65/85	250	1	106	123	115	50	100	5.2	3.82	
0 442 16/36/46/66/86	400	1	120	140	140	62.5	125	5.2	5.62	
0 442 17/37/47/67/87	630	2	132	155	175	75	150	5.5	8	
0 442 18/38/48/68/88	1000	2	150	199	206	100	175	7	14.9	
0 442 39/49/69/89	1600	3	220	245	191	150	153	9	25.6	
0 442 40/50/70/90	2500	3	300	292	171	200	114	9	33.1	
0 442 71/91	4000	4	230	340	205	180	130	11	31	
0 442 72	5000	4	240	390	205	180	130	11	40	
0 442 73	6300	4	240	390	205	180	130	11	45	
0 442 74	8000	4	240	390	280	180	140	11	64	

1: Direct fixing possibility on symmetrical rail up to 250 VA

## ■ Fixing

On perforated plates Lina 25 and on Lina 12.5 plates  
On symmetrical rail up to 250 VA  
fixing centres pitch 25 mm up to 1000 VA

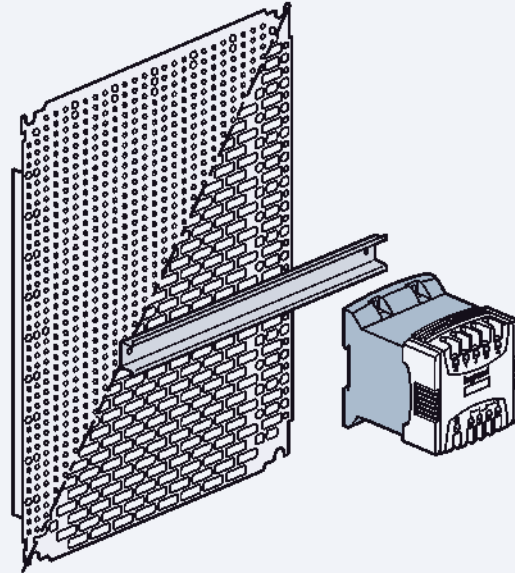

Attachment at 3 points possible with through oblong on the secondary side

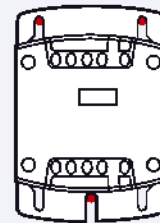

## ■ Associated protection

Nominal power (VA) acc. to IEC and CSA	24 V		48 V		115 V		230 V	
	Rating	MCBs Cat.Nos	Rating	MCBs Cat.Nos	Rating	MCBs Cat.Nos	Rating	MCBs Cat.Nos
40	2	T2AL <sup>(1)</sup>	1	T1AL <sup>(1)</sup>	0.4	T0.4AL <sup>(1)</sup>	0.2	T0.2AL <sup>(1)</sup>
63	3.15	T3.15AL <sup>(1)</sup>	1.6	T1.6AL <sup>(1)</sup>	0.63	T0.63AL <sup>(1)</sup>	0.315	T0.315AL <sup>(1)</sup>
100	4	4 076 95	2	4 076 93	1	4 076 92	0.5	4 076 91
160	8	4 076 97	4	4 076 95	2	4 076 93	1	4 076 92
250	10	4 076 98	6	4 076 96	2	4 076 93	1	4 076 92
400	16	4 077 00	8	4 076 97	4	4 076 95	2	4 076 93
630	25	4 077 02	13	4 076 99	6	4 076 96	3	4 076 94
1000	40	4 077 04	20	4 077 01	8	4 076 97	4	4 076 95
1600	63	4 077 90	32	4 077 03	13	4 076 99	8	4 076 97
2500	100	4 092 29	50	4 077 89	20	4 077 01	10	4 076 98
4000					32	4 077 03	16	4 077 00
5000					40	4 077 04	20	4 077 01
6300					50	4 077 89	25	4 077 02
8000					63	4 077 90	32	4 077 03

1: Fuse IEC 127 (5x20 T type cartridge fuse) - T: Time-lag fuse - L: Low breaking capacity



# Equipment transformers

## single-phase

### Characteristics

- Insulation voltage:
- between windings: 4 470 V
  - between primary and earth: 2 240 V
  - between secondary and earth: 250 V for 12, 24 and 48 V and 1780 V for 115 and 230 V

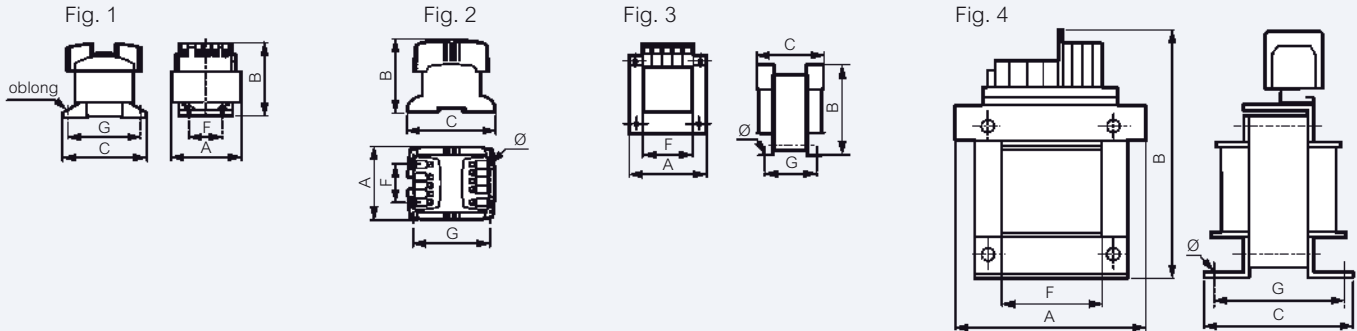

Cat.Nos	Power (VA)	AIO (VA) cos φ 0.5	Fig.	Dimensions (mm)			Fixing (mm)			Weight (kg)	No load loss (W)	Total losses at 100% load (W)	Voltage drop (%)		Efficiency (%)		Ucc (%)	Connection PRI			Connection SEC		
				A	B	C	F	G	Ø				cos φ 1	cos φ 0.45	cos φ 1	cos φ 0.45		flexible	rigid	lug Ø (mm)	flexible	rigid	lug Ø (mm)
<b>Single-phase safety transformers: Primary 230-400 V - Sec 12-24 V</b>																							
0 428 40	40	55	1	84	70	98	40	86	4.5	0.9	3.7	13.1	18.3	12.7	0.75	0.58	15.6	1 to 4	1 to 4	4.5	1 to 4	1 to 4	4.5
0 428 41	63	91	1	84	77	98	40	86	4.5	1.3	4.9	16.3	13.5	10.2	0.79	0.64	11.8	1 to 4	1 to 4	4.5	1 to 4	1 to 4	4.5
0 428 42	100	140	1	84	86	98	40	86	4.5	1.6	6.2	21	10.5	8.7	0.83	0.68	9.5	1 to 4	1 to 4	4.5	1 to 4	1 to 4	4.5
0 428 43	160	205	1	84	104	98	40	86	4.5	2.4	9.1	31.8	8.8	7.4	0.83	0.69	7.9	1 to 4	1 to 4	4.5	1 to 4	1 to 4	4.5
0 428 44	220	290	1	96	115	110	40	98	4.5	3.4	12.6	40	6.9	6.3	0.85	0.71	6.5	1 to 4	1 to 4	4.5	1 to 4	1 to 4	4.5
0 428 45	310	345	2	106	123	115	50	100	5.2	3.82	14.2	54.9	7.3	6.2	0.85	0.72	8.2	1 to 4	1 to 4	4.5	1 to 4	1 to 4	4.5
0 428 46	450	1100	3	126	126	126	90	94	6.5	6	21.8	63.9	6	3.2	0.88	0.76	4.9	1 to 4	1 to 4	4.5	1 to 16	1 to 25	6.5
0 428 47	630	1520	3	126	126	141	90	105	6.5	8	25.5	62.4	4.3	2.6	0.91	0.82	3.5	1 to 4	1 to 4	4.5	1 to 16	1 to 25	6.5
0 428 49	1000	4130	4	220	222	170	122	140	7	14.7	43.3	76.2	2.9	1.8	0.93	0.86	2.4	0.25 to 6	0.5 to 10	-	4 to 35	2.5 to 50	-
<b>Single-phase safety transformers: Primary 230-400 V - Sec 24 V</b>																							
0 428 55	40	55	1	84	70	98	40	86	4.5	0.9	3.7	13.1	18.3	12.7	0.75	0.58	15.6	1 to 4	1 to 4	4.5	1 to 4	1 to 4	4.5
0 428 56	63	91	1	84	77	98	40	86	4.5	1.3	4.9	16.3	13.5	10.2	0.79	0.64	11.8	1 to 4	1 to 4	4.5	1 to 4	1 to 4	4.5
0 428 57	100	140	1	84	86	98	40	86	4.5	1.6	6.2	21	10.5	8.7	0.83	0.68	9.5	1 to 4	1 to 4	4.5	1 to 4	1 to 4	4.5
0 428 58	160	205	1	84	104	98	40	86	4.5	2.4	9.1	31.8	8.8	7.4	0.83	0.69	7.9	1 to 4	1 to 4	4.5	1 to 4	1 to 4	4.5
0 428 59	220	290	1	96	115	110	40	98	4.5	3.4	12.6	40	6.9	6.3	0.85	0.71	6.5	1 to 4	1 to 4	4.5	1 to 4	1 to 4	4.5
0 428 60	310	345	2	106	123	115	50	100	5.2	3.82	14.2	54.9	7.3	6.2	0.85	0.72	8.2	1 to 4	1 to 4	4.5	1 to 4	1 to 4	4.5
0 428 61	450	1100	3	126	126	126	90	94	6.5	6	21.8	63.9	6	3.2	0.88	0.76	4.9	1 to 4	1 to 4	4.5	1 to 16	1 to 25	6.5
0 428 62	630	1520	3	126	126	141	90	105	6.5	8	25.5	62.4	4.3	2.6	0.91	0.82	3.5	1 to 4	1 to 4	4.5	1 to 16	1 to 25	6.5
<b>Single-phase safety transformers: Primary 230-400 V - Sec 24-48 V</b>																							
0 428 70	40	55	1	84	77	98	40	86	4.5	1.3	3.9	7.7	6.3	6.5	0.83	0.71	6.1	1 to 4	1 to 4	4.5	1 to 4	1 to 4	4.5
0 428 71	63	80	1	84	86	98	40	86	4.5	1.6	5.2	11.7	7.7	6.9	0.83	0.72	6.9	1 to 4	1 to 4	4.5	1 to 4	1 to 4	4.5
0 428 72	100	150	1	84	104	98	40	86	4.5	2.4	7.9	14.2	4.1	4.5	0.87	0.76	4.6	1 to 4	1 to 4	4.5	1 to 4	1 to 4	4.5
0 428 73	160	160	1	84	104	98	40	86	4.5	2.4	7.9	21.2	7.3	7.6	0.87	0.77	7.4	1 to 4	1 to 4	4.5	1 to 4	1 to 4	4.5
0 428 74	220	290	1	96	115	110	40	98	4.5	3.4	12.6	39.5	6.7	6.2	0.85	0.71	6.3	1 to 4	1 to 4	4.5	1 to 4	1 to 4	4.5
0 428 75	310	345	2	106	123	115	50	100	5.2	3.82	14.2	54.9	7.3	6.2	0.85	0.72	8.2	1 to 4	1 to 4	4.5	1 to 4	1 to 4	6.5
0 428 76	450	708	2	120	140	140	62.5	125	5.2	5.62	18.4	66	6.2	5.4	0.87	0.75	4.6	1 to 4	1 to 4	4.5	1 to 4	1 to 4	6.5
0 428 77	630	1520	3	126	126	141	90	105	6.5	8	25.5	64.3	4.2	2.6	0.91	0.82	3.5	1 to 4	1 to 4	4.5	1 to 16	1 to 25	6.5
<b>Single-phase circuits isolation transformers: Primary 230-240 V - Sec 115-230 V</b>																							
0 427 85	40	55	1	84	70	98	40	86	4.5	1	3.7	10.9	15.6	12.6	0.79	0.62	14.2	1 to 4	1 to 4	4.5	1 to 4	1 to 4	4.5
0 427 86	63	91	1	84	77	98	40	86	4.5	1.3	4.9	15.6	12.5	9.7	0.8	0.65	11	1 to 4	1 to 4	4.5	1 to 4	1 to 4	4.5
0 427 87	100	140	1	84	86	98	40	86	4.5	1.6	6.2	21.1	10.7	8.9	0.83	0.68	9.7	1 to 4	1 to 4	4.5	1 to 4	1 to 4	4.5
0 427 88	160	205	1	84	104	98	40	86	4.5	2.4	9.1	32.3	8.8	7.3	0.83	0.69	7.9	1 to 4	1 to 4	4.5	1 to 4	1 to 4	4.5
0 427 89	220	290	1	96	115	110	40	98	4.5	3.4	12.6	40.1	6.8	6.2	0.85	0.71	6.4	1 to 4	1 to 4	4.5	1 to 4	1 to 4	4.5
0 427 90	310	345	2	106	123	115	50	100	5.2	3.82	14.2	54	7.3	6.2	0.85	0.72	6.7	1 to 4	1 to 4	4.5	1 to 4	1 to 4	4.5
0 427 91	450	708	2	120	140	140	62.5	125	5.2	5.62	18.4	64	5.9	5.1	0.88	0.76	4.3	1 to 4	1 to 4	4.5	1 to 4	1 to 4	4.5
0 427 92	630	1520	3	126	126	123	90	105	6.5	7.8	25.5	64.6	4.3	2.6	0.91	0.81	4.2	1 to 4	1 to 4	4.5	1 to 4	1 to 4	4.5

# Transformers and auto-transformers IP55

single-phase

## Safety transformers

Insulation voltages:

- Between windings: 4500 V for 230-400 V, 3550 V for 230 V
- Between primary and earth: 2250 V for 230-400 V, 1800 V for 230 V
- Between secondary and earth: 250 V
- Class II

Insulation class B, ambient temperature: 25°C

IP 55 - IK 07

Secondary voltage by series-parallel connection: supplied with links

Cat. Nos 0 427 20 to 27 and 0 427 60 to 65

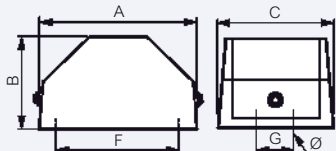

### 230-400 V/24-48 V

Cat. Nos	No-load loss (W)	Voltage drop (%)		Efficiency		Usc (%)	Dimensions (mm)			Fixing (mm)			Weight (kg)
		cos φ 1	cos φ 0.45	cos φ 1	cos φ 0.45		A	B	C	F	G	Ø	
0 427 20	8.7	8.5	4.2	0.82	0.68	6.7	182	92	112	143	-	6	3.6
0 427 21	7.8	7.6	3.7	0.88	0.76	6.1	192	92	112	158	-	6	4.2
0 427 22	14.5	7.6	3.6	0.86	0.74	6.1	207	100	122	167	-	6	6.3
0 427 23	13.3	7.9	3.9	0.89	0.78	6.4	215	100	122	175	-	6	6.7
0 427 24	17.3	6.4	3.7	0.90	0.80	5.3	245	130	156	203	50	6	11.5
0 427 25	30.5	4.6	2.5	0.92	0.84	3.7	290	150	190	247	50	6	19.2
0 427 26	32.7	3.7	3	0.94	0.87	3.4	290	150	190	247	50	6	19.7

### 230 V/12 V

Cat. Nos	No-load loss (W)	Voltage drop (%)		Efficiency		Usc (%)	Dimensions (mm)			Fixing (mm)			Weight (kg)
		cos φ 1	cos φ 0.45	cos φ 1	cos φ 0.45		A	B	C	F	G	Ø	
0 427 60	8.7	8.5	4.2	0.82	0.68	6.7	182	92	112	143	-	6	3.5
0 427 61	7.6	10.6	5.0	0.78	0.61	8.4	182	92	112	143	-	6	3.5
0 427 62	8.4	9.2	4.5	0.84	0.71	7.4	192	92	112	158	-	6	4.1
0 427 63	15.5	7.9	3.6	0.89	0.78	5.7	215	100	122	175	-	6	6.6
0 427 64	27.3	7.8	3.7	0.79	0.62	6.2	265	130	156	223	50	6	11.9
0 427 65	31.3	4.6	2.5	0.92	0.84	3.7	290	150	190	247	50	6	19

## Circuit isolation transformers

Insulation voltages:

- Between windings: 4500 V
- Between primary and earth: 2250 V
- Between secondary and earth: 1800 V for 230 V, 2240 V for 400 V

• Class II

Insulation class B, ambient temperature: 25°C

IP 55 - IK 07

Secondary voltage by series-parallel connection: supplied with links

Cat. Nos 0 425 10 to 16

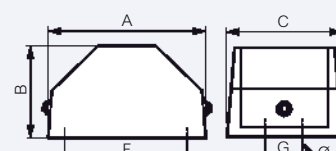

### 230-400 V/115-230 V

Cat. Nos	No-load loss (W)	Voltage drop (%)		Efficiency		Usc (%)	Dimensions (mm)			Fixing (mm)			Weight (kg)
		cos φ 1	cos φ 0.45	cos φ 1	cos φ 0.45		A	B	C	F	G	Ø	
0 425 10	9.6	13.4	6.2	0.77	0.6	11	182	92	112	143	-	6	3.5
0 425 11	10.4	11.9	5.4	0.88	0.77	12	192	92	112	158	-	6	4.3
0 425 12	16.2	7.1	3.7	0.83	0.69	6	207	100	122	167	-	6	6.3
0 425 13	15.7	8.5	4	0.88	0.77	8	215	100	122	175	-	6	6.7
0 425 14	27.3	6.3	3.5	0.87	0.75	5	245	130	156	203	50	6	11.5
0 425 15	30.9	4.7	3.2	0.9	0.8	4	270	150	190	227	50	6	18.6
0 425 16	30.9	2.2	1.8	0.93	0.86	2	270	150	190	227	50	6	18.7

## Auto-transformers

50-60 Hz. Class II

Insulation voltages:

- Between winding and earth: 3000 V

Insulation:

- Class B up to 2000 VA, ambient temperature: 35°C

IP 55 - IK 07 up to 2000 VA

Cat. Nos 0 422 82 to 88

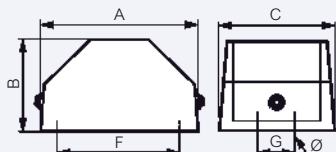

### Single-phase protected

Cat. Nos	No-load loss (W)	Voltage drop (%) cos φ 0.8	Efficiency cos φ 0.8	Usc (%)	Dimensions (mm)			Fixing (mm)			Weight (kg)
					A	B	C	F	G	Ø	
0 422 82	5	7.5	0.78	8.2	182	92	112	143	-	6	3.5
0 422 84	11.8	5	0.71	6.1	207	100	122	167	-	6	6.3
0 422 85	12.2	3.9	0.77	4.5	207	100	122	167	-	6	6.3
0 422 86	19.2	3.2	0.82	3.6	245	130	156	203	50	6	11.5
0 422 87	30.6	1.8	0.86	2.1	270	150	190	227	50	6	18.7
0 422 88	33.7	1.9	0.8	2.3	270	150	190	227	50	6	18.7



# Transformers sizing

## Which transformer for which circuit ?

Each circuit needs a specific transformer output: transformer sizing. But, to size an equipment transformer it is not enough to add up the powers of the operating circuits, the permissible instantaneous power must be considered (inrush power)

## How to calculate a transformer's power and size?

For equipment including automatic devices, transformer's power depends on:

- The max. power needed at a given moment (inrush power)
- Constant power absorbed by the circuit
- Voltage drop
- Power factor

### 1) Determining the inrush power

To determine the inrush power, we make the following assumptions:

- Two inrushes cannot occur at the same time
- Power factor  $\cos \phi$  0.5 at closing
- Max. 80 % of devices power supplied at the same time

Empirically and to simplify, this power can be calculated using the following formula:

$$P_{\text{inrush}} = 0.8 (\sum P_m + \sum P_v + P_a)$$

$\sum P_m$ : sum of all contactors holding powers

$\sum P_v$ : sum of all indicators light powers

$P_a$ : inrush power of the largest contactor

### Example :

A machine tool control cabinet contains :

- 10 contactors for 4-kW motors, holding power 8 VA
- 4 contactors for 18.5-kW motor, holding power 20 VA
- 1 contactor for 45-kW motor, holding power 20 VA, inrush power 250 VA  $\cos \phi$  0.5
- 25 remote control relays, holding power 4 VA
- 45 signalling lights, consumption 1 VA

$$\begin{aligned} \sum P_m &= 10 \times 8 \text{ VA} = 80 \text{ VA} \\ &4 \times 20 \text{ VA} = 80 \text{ VA} \\ &1 \times 20 \text{ VA} = 20 \text{ VA} \\ &25 \times 4 \text{ VA} = 100 \text{ VA} \\ &\underline{\hspace{1.5cm}} \\ &280 \text{ VA} \end{aligned}$$

$$\begin{aligned} \sum P_v &= 45 \times 1 \text{ VA} = 45 \text{ VA} \\ P_a &= 250 \text{ VA} \end{aligned}$$

$$P_{\text{inrush}} = 0.8 (280 + 45 + 250) = 460 \text{ VA at } \cos \phi 0.5$$

### 2) Determining the transformer's size

Especially for control transformers, just read the size below from the inrush power at  $\cos \phi$  0.5:

Nominal power VA IEC and CSA	Permissible instantaneous power VA IEC/EN 61558-2-2 with $\cos \phi$ of :								
	0.2	0.3	0.4	0.5	0.6	0.7	0.8	0.9	1
40	90	80	72	66	61	57	53	51	53
63	160	140	130	120	110	100	90	90	90
100	210	190	170	160	150	140	130	130	140
160	480	400	350	300	270	240	220	200	190
250	830	690	590	510	450	400	360	330	310
400	1600	1400	1200	1000	900	800	800	700	700
630	2000	1800	1500	1400	1200	1100	1100	1000	1000
1000	5400	4600	4000	3600	3200	3000	2700	2600	2500
1600	9000	8000	7200	6600	6100	5700	5400	5300	5600
2500	7300	6600	6000	5700	5200	4900	4700	4600	5100
4000	34500	28800	24400	17000	16600	16400	14800	13400	12400
5000	29000	23000	20000	17000	16000	14000	13000	12000	12000
6300	20000	18000	17000	16000	15000	15000	15000	15000	18000
8000	45000	39000	35000	32000	30000	28000	27000	26000	29000

Inrush power of 460 VA at  $\cos \phi$  0.5 entails minimum size of 250 VA

## Voltage drop sizing curves at $\cos \phi$ 0.5

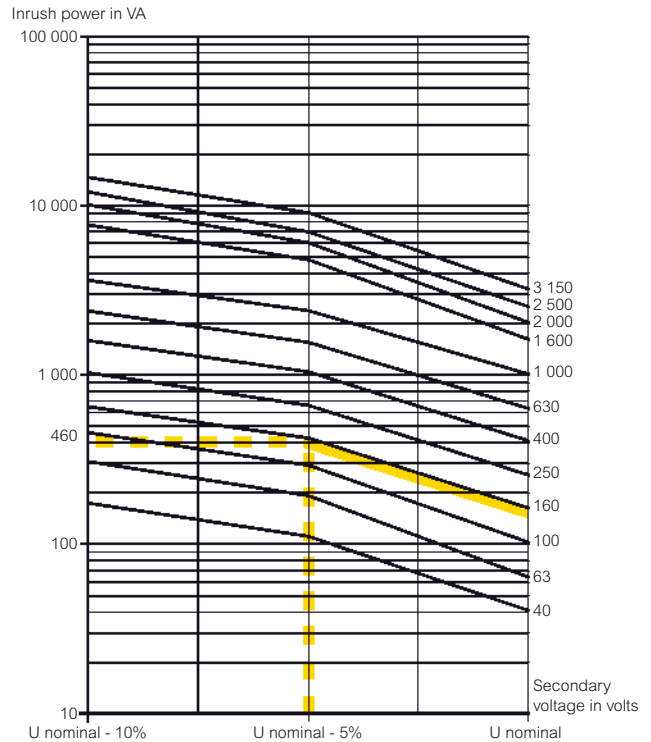

For power of 460 VA  $\cos \phi$  0.5, the curve at U nominal - 5%\* indicates a value of 160 VA

\* Value deliberately selected as a precaution

### 3) Checking the choice

Make a check according to each piece of equipment :

- calculate the total sum of the holding powers of the windings and of the live indicator lights
  - then apply a factor: either that of 80 % of devices held live at the same time, or that from the actual calculations for your equipment
- The sizing power must be equal to or more than the result of this calculation

### Rule for determining the secondary protection rating :

To check that the device chosen is suitable, an approximate minimum short-circuit value at the furthest point of the installation can be obtained using the following formula:

$$I_{c/c \text{ mini}} = \frac{U_s}{\left( \frac{U_s^2}{P} \times \frac{U_{c/c \%}}{100} \right) + \frac{2pl}{S}}$$

$U_s$  = transformer secondary voltage

$P$  = transformer power

$U_{c/c \%}$  = transformer short-circuit voltage

$l$  = line length in m

$S$  = line cross-section in  $\text{mm}^2$

$\rho$  copper =  $0.027 \Omega \text{ mm}^2/\text{m}$

Choose the protection rating so as to obtain a cut-off time of 5" max. for the current  $I_{c/c}$  defined above :

$$gG \text{ fuse : } I_n \leq \frac{I_{c/c \text{ min.}}}{4} \quad \text{type C MCB : } I_n \leq \frac{I_{c/c \text{ min.}}}{8}$$

### Example : control transformer 630 VA - 230/24 V Cat.No 0 442 17

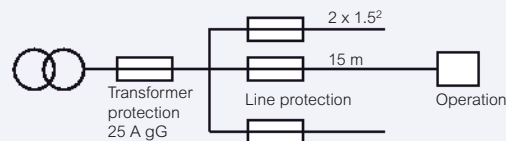

$$I_{c/c \text{ min.}} = \frac{24}{\left( \frac{24^2}{630} \times \frac{3.7}{100} \right) + \frac{2 \times 0.027 \times 15}{1.5}} = 41.82 \text{ A}$$

$$\frac{41.82}{4} = 10.45 \rightarrow gG 10 \text{ A max.} \quad \frac{41.82}{8} = 5.22 \rightarrow DX 5 \text{ A max. C.curve}$$

# Protection of transformers and their lines

## Protection of lines

### General

Lines must be protected against overloads and short-circuits. Protection against overloads is only compulsory if the line is likely to be affected by an overload current. This protection can be installed at the head or end of the line. Protection against short-circuits is compulsory in all installations ; this protection has to be installed at the head of the line

### Supply line (transformer primary)

The transformer is a device that cannot generate overloads. Its supply line requires protection against short-circuits only. When a transformer is energised, a very high inrush current is produced (in the region of 25 In) for approximately 10 ms. The line protection must take these 2 factors into consideration. Legrand offers 3 possibilities: aM fuse cartridges, type D MCBs (average value of the magnetic 12 In, with a standard adjustment range between 10 and 14 In), type C MCBs (average value of the magnetic 7 In, with a standard adjustment range between 5 and 10 In)

### Minimal protection rating for primary supply line on transformer<sup>(1)</sup>

Power	230 V single - phase				400 V single - phase			230 V three - phase			400 V three - phase		
	aM Cartridge	MCBs C curve or MCCBs	MCBs D curve or MCCBs	type B MCB with inrush current limiter	aM Cartridge	MCBs C curve or MCCBs	MCBs D curve or MCCBs	aM Cartridge	MCBs C curve or MCCBs	MCBs D curve or MCCBs	aM Cartridge	MCBs C curve or MCCBs	MCBs D curve or MCCBs
40 VA	0.5 A 0 130 95	1 A 4 077 76		1 A 4 089 52	0.25 A 0 130 92	1 A 4 077 76							
63 VA	1 A 0 130 01	2 A 4 077 77		1 A 4 089 52	0.5 A 0 130 95	1 A 4 077 76	0.5 A 4 080 07						
100 VA	1 A 0 130 01	3 A 4 077 78	1 A 4 080 08	1 A 4 089 52	1 A 0 130 01	2 A 4 077 77	1 A 4 080 08						
160 VA	2 A 0 130 02	4 A 4 077 79	2 A 4 080 09	2 A 4 089 52	1 A 0 130 01	2 A 4 077 77	1 A 4 080 08						
220 VA	2 A 0 130 02	6 A 4 077 80	3 A 4 080 10	3 A 4 089 53	1 A 0 130 01	3 A 4 077 78	2 A 4 080 09						
250 VA	2 A 0 130 02	6 A 4 077 80	3 A 4 080 10	3 A 4 089 53	2 A 0 130 02	3 A 4 077 78	2 A 4 080 09						
310 VA	4 A 0 130 04	8 A 4 077 81	4 A 4 080 10	4 A 4 089 53	2 A 0 130 02	4 A 4 077 79	2 A 4 080 09						
400 VA	4 A 0 130 04	10 A 4 077 82	6 A 4 080 11	6 A 4 089 54	2 A 0 130 02	6 A 4 077 80	3 A 4 080 10	2 A 0 130 02	6 A 4 078 25	3 A 4 080 55	2 A 0 130 02	3 A 4 078 23	2 A 4 080 54
450 VA	4 A 0 130 04	10 A 4 077 82	6 A 4 080 12	6 A 4 089 54	2 A 0 130 02	6 A 4 077 80	3 A 4 080 10						
630 VA	6 A 0 130 06	16 A 4 077 84	10 A 4 080 12	10 A 4 089 56	4 A 0 130 04	8 A 4 077 81	4 A 4 080 11	4 A 0 130 04	10 A 4 078 27	4 A 4 080 56	2 A 0 130 02	6 A 4 078 25	2 A 4 080 54
800 VA	6 A 0 130 06	16 A 4 077 84	10 A 4 080 14	10 A 4 089 56	4 A 0 130 04	10 A 4 077 82	6 A 4 080 12						
1000 VA	10 A 0 130 10	20 A 4 077 85	10 A 4 080 14	10 A 4 089 57	4 A 0 130 04	16 A 4 077 84	6 A 4 080 12	4 A 0 130 04	16 A 4 078 29	6 A 4 080 57	4 A 0 130 04	10 A 4 078 27	4 A 4 080 56
1250 VA	10 A 0 130 10	25 A 4 077 86	16 A 4 080 15	16 A 4 089 57	6 A 0 130 06	16 A 4 077 84	8 A 4 080 13						
1600 VA	10 A 0 130 10	32 A 4 077 87	16 A 4 080 15	16 A 4 089 57	6 A 0 130 06	20 A 4 077 85	10 A 4 080 14	6 A 0 130 06	20 A 4 078 30	10 A 4 080 58	4 A 0 130 04	16 A 4 078 29	6 A 4 080 57
2000 VA	12 A 0 130 12	40 A 4 077 88	20 A 4 080 16	20 A 4 089 59	8 A 0 130 08	25 A 4 077 86	16 A 4 080 15	10 A 0 130 10	25 A 4 078 31	16 A 4 080 59	6 A 0 130 06	16 A 4 078 29	10 A 4 080 58
2500 VA	16 A 0 130 16	50 A 4 077 89	25 A 4 080 17	25 A 4 089 60	10 A 0 130 10	32 A 4 077 87	16 A 4 080 15	10 A 0 130 10	32 A 4 078 32	16 A 4 080 59	6 A 0 130 06	20 A 4 078 30	10 A 4 080 58
4 kVA	25 A 0 130 25	80 A 4 092 28	32 A 4 080 18	32 A 4 089 61	16 A 0 130 16	40 A 4 077 88	20 A 4 080 16	16 A 0 130 16	50 A 4 078 34	25 A 4 080 61	10 A 0 130 10	32 A 4 078 32	16 A 4 080 59
5 kVA	32 A 0 140 32	80 A 4 092 28	40 A 4 080 19	40 A 4 089 63	16 A 0 130 16	50 A 4 077 89	25 A 4 080 17	20 A 0 130 20	63 A 4 078 35	32 A 4 080 62	12 A 0 130 12	40 A 4 078 33	20 A 4 080 60
6.3 kVA	32 A 0 140 32	100 A 4 092 29	50 A 4 080 20	50 A 4 089 64	20 A 0 130 20	63 A 4 077 90	32 A 4 080 18	25 A 0 130 25	80 A 4 092 80	40 A 4 080 63	16 A 0 130 16	50 A 4 078 34	25 A 4 080 61
8 kVA	40 A 0 140 40		63 A 4 080 21	63 A 4 089 65	25 A 0 130 25		40 A 4 080 19	32 A 0 140 32	100 A 4 092 81	50 A 4 080 64	20 A 0 130 20	63 A 4 078 35	32 A 4 080 62
10 kVA	63 A 0 150 63		80 A 4 094 58		32 A 0 140 32		50 A 4 080 20	32 A 0 140 32	100 A 4 092 81	50 A 4 080 64	20 A 0 130 20	63 A 4 078 35	32 A 4 080 62
12.5 kVA	63 A 0 150 63		100 A 4 094 59		40 A 0 140 40		63 A 4 080 21						
16 kVA	80 A 0 150 80		160 A 4 200 07		50 A 0 140 50		80 A 4 094 58	50 A 0 140 50	80 A 4 095 06	32 A 0 140 32			50 A 4 080 64
20 kVA	100 A 0 150 96		160 A 4 200 07		63 A 0 150 63		100 A 4 094 59	63 A 0 150 63	100 A 4 095 07	40 A 0 140 40			63 A 4 080 65
25 kVA	125 A 0 150 97		200 A 4 200 08		80 A 0 150 80		125 A 4 094 60	80 A 0 150 80	125 A 4 095 08	50 A 0 140 50			80 A 4 095 06
31.5 kVA	160 A 0 165 55		250 A 4 200 09		100 A 0 150 96		160 A 4 200 07	100 A 0 150 96	160 A 4 200 07	63 A 0 150 63			100 A 4 095 07
40 kVA	200 A 0 170 60		320 A 0 255 22		125 A 0 150 97		200 A 4 202 08	125 A 0 150 97	200 A 4 202 09	75 A 0 150 63			125 A 4 095 08
50 kVA	315 A 0 175 70		400 A 0 255 23		160 A 0 165 55		250 A 4 202 09	160 A 0 165 55	250 A 4 202 09	80 A 0 150 80			160 A 4 200 07
63 kVA	315 A 0 175 70		500 A 0 255 25		200 A 0 170 60		320 A 0 255 22	200 A 0 170 60	250 A 4 202 09	100 A 0 150 96			160 A 4 200 07
80 kVA								250 A 0 170 65	250 A 0 252 06	160 A 0 165 55			160 A 4 200 07
100 kVA								315 A 0 175 70	320 A 0 255 22	160 A 0 165 55			160 A 4 200 07
125 kVA								400 A 0 175 75	400 A 0 255 23	200 A 0 170 60			200 A 4 202 08
160 kVA								500 A 0 180 25	500 A 0 255 25	250 A 0 170 65			250 A 0 252 06
200 kVA								630 A 0 180 30	630 A 0 255 24	315 A 0 175 70			320 A 0 255 22
250 kVA								630 A 0 180 30	630 A 0 255 24	400 A 0 175 75			400 A 0 255 23

### Operating line (transformer secondary)

This line must be protected against overloads (ensure that the protection rating chosen is  $\leq$  transformer secondary current) and short-circuits (ensure that a short-circuit occurring at the furthest point of the line will trigger the protective device within 5 seconds. Legrand offers two possibilities: gG cartridge fuses, type C MCBs (magnetic set to 7 In average). If the transformer only supplies a single operating line, and provided the calculations show perfect compatibility, transformer protection (if on the secondary) and line protection can be one and the same. A single protective device performs both functions (see table of transformer protective devices). If the transformer supplies several operating lines, overload and short-circuit calculations must be performed for each individual line

1: These values are given for information only for transformers with inrush currents of around 25 In.  
2: Thermal adjustment

## Protection of transformers

According to IEC/EN 61558 standards, transformers must be protected against overloads and short-circuits which may occur during normal operations

The standards do not specify the location or type of protective device: it is the manufacturer's responsibility to select the most suitable position, either on the primary or secondary side

Legrand has selected secondary protection. The rating, type and location of the protective device are indicated on the front of its devices

**Single-phase:** Control, safety isolating, isolating, equipment and installation transformers

Nominal power IEC and CSA	12 V				24 V				48 V				115 V				230 V			
	Rating	Cartridge Cat.Nos	Rating	MCBS Cat.Nos	Rating	Cartridge Cat.Nos	Rating	MCBS Cat.Nos	Rating	Cartridge Cat.Nos	Rating	MCBS Cat.Nos	Rating	Cartridge Cat.Nos	Rating	MCBS Cat.Nos	Rating	Cartridge Cat.Nos	Rating	MCBS Cat.Nos
40 VA	4	T4 AL <sup>(1)</sup>			2	T2 AL <sup>(1)</sup>			1	T1 AL <sup>(1)</sup>			0,4	T0,4 AL <sup>(1)</sup>			0,2	T0,2 AL <sup>(1)</sup>	0,2	T0,2 AL <sup>(1)</sup>
63 VA	5	T5 AL <sup>(1)</sup>			2,5	T2,5 AL <sup>(1)</sup>			1,25	T1,25 AL <sup>(1)</sup>			0,5	T0,5 AL <sup>(1)</sup>			0,25	T0,25 AL <sup>(1)</sup>	0,25	T0,25 AL <sup>(1)</sup>
100 VA	8	T8 AE <sup>(1)</sup>	8	4 076 97	4	T4 AE <sup>(1)</sup>	4	4 076 95	2	T2 AE <sup>(1)</sup>	2	4 076 93	0,8	T0,8 AL <sup>(1)</sup>	1	4 076 92	0,4	T0,4 AL <sup>(1)</sup>	0,5	4 076 91
160 VA	16	0 133 16	13	4 076 99	8	0 133 08	6	4 076 96	3,15	T3,15 AE <sup>(1)</sup>	4	4 076 95	1,6	T1,6 AL <sup>(1)</sup>	2	4 076 93	0,63	T0,63 AL <sup>(1)</sup>	1	4 076 92
220 VA	20	0 133 20	20	4 077 01	10	0 133 10	10	4 076 98	5	T5 AE <sup>(1)</sup>	6	4 076 96	2	T2 AL <sup>(1)</sup>	2	4 076 93	1	T1 AL <sup>(1)</sup>	1	4 076 92
250 VA	20	0 133 20	20	4 077 01	10	0 133 10	10	4 076 98	6	0 133 06	6	4 076 96	2	T2 AL <sup>(1)</sup>	2	4 076 93	1	T1 AL <sup>(1)</sup>	1	4 076 92
310 VA	25	0 133 25	25	4 077 02	12	0 133 12	13	4 076 99	6	0 133 06	6	4 076 96	2,5	T2,5 AE <sup>(1)</sup>	3	4 076 94	1,25	T1,25 AL <sup>(1)</sup>	2	4 076 93
400 VA	32	0 143 32	32	4 077 03	16	0 133 16	16	4 077 00	8	0 133 08	8	4 076 97	4	0 133 04	4	4 076 95	2	0 133 02	2	4 076 93
450 VA	40	0 143 40	40	4 077 04	20	0 133 20	20	4 077 01	10	0 133 10	10	4 076 98	4	0 133 04	4	4 076 95	2	0 133 02	2	4 076 93
630 VA	50	0 143 50	50	4 076 59	25	0 133 25	25	4 077 02	12	0 133 12	13	4 076 99	6	0 133 06	6	4 076 96	4	0 133 04	3	4 076 94
1000 VA	80	0 153 80	80	4 091 40	40	0 143 40	40	4 077 04	20	0 133 20	20	4 077 01	8	0 133 08	8	4 076 97	4	0 133 04	4	4 076 95
1600 VA	125	0 153 97	125	4 091 42	63	0 153 63	63	4 076 60	32	0 143 32	32	4 077 03	16	0 133 16	13	4 076 99	8	0 133 08	8	4 076 97
2500 VA			200		100	0 153 96	100	4 091 41	50	0 143 50	50	4 076 59	20	0 133 20	20	4 077 01	10	0 133 10	10	4 076 98
4 kVA									80	0 153 80	80	4 091 40	32	0 143 32	32	4 077 03	16	0 133 16	16	4 077 00
5 kVA									100	0 153 96	100	4 091 41	40	0 143 40	40	4 077 04	20	0 133 20	20	4 077 01
6.3 kVA									125	0 153 97	125	4 091 42	50	0 143 50	63	4 076 59	25	0 133 25	32	4 077 02
8 kVA													80	0 153 80	80	4 091 40	32	0 143 32	32	4 077 03
10 kVA													80	0 153 80	80	4 091 40	40	0 143 40	40	4 077 04
12.5 kVA													100	0 153 96	100	4 091 41	50	0 143 50	50	4 076 59
16 kVA													160	0 163 55	160	4 200 47	80	0 153 80	80	4 091 40
20 kVA													160	0 163 55	200	4 202 08	80	0 153 80	80	4 091 40
25 kVA													200	0 168 60	250	4 202 09	100	0 153 96	100	4 091 41
31.5 kVA													250	0 173 65	250	4 202 09	125	0 153 97	125	4 092 30
40 kVA													400	0 178 75	320	0 255 22	160	0 163 55	200	4 202 08
50 kVA													400	0 178 75	400	0 255 23	200	0 168 60	250	4 202 09
63 kVA													500	0 181 25	500	0 255 35	250	0 173 65	250	4 202 09

1: Fuses IEC 127 (cartridge 5 x 20 T type)

**Three - phase:** Control, safety isolating, isolating, equipment and installation transformers

Nominal power	24 V				42 V				230 V				400 V			
	Rating	Cartridge Cat.Nos	Rating	MCBS Cat.Nos	Rating	Cartridge Cat.Nos	Rating	MCBS Cat.Nos	Rating	Cartridge Cat.Nos	Rating	MCBS Cat.Nos	Rating	Cartridge Cat.Nos	Rating	MCBS Cat.Nos
400 VA	10	0 133 10	10	4 078 96	6	0 133 06	6	4 078 94	1	0 133 01	1	4 078 90	1	0 133 01	1	4 078 90
630 VA	16	0 133 16	16	4 078 98	10	0 133 10	10	4 078 96	2	0 133 02	2	4 078 91	1	0 133 01	1	4 078 90
1000 VA	25	0 133 25	25	4 079 00	16	0 133 16	16	4 078 98	4	0 133 04	3	4 078 92	2	0 133 02	2	4 078 91
1600 VA	40	0 143 40	40	4 079 02	25	0 133 25	20	4 078 99	4	0 133 04	6	4 078 94	4	0 133 04	3	4 078 92
2500 VA	63	0 153 63	63	4 079 04	40	0 143 40	32	4 079 01	6	0 133 06	6	4 078 94	4	0 133 04	6	4 078 94
4 kVA	100	0 153 96	100	4 093 63	63	0 153 63	50	4 079 03	10	0 133 10	10	4 078 96	6	0 133 06	6	4 078 94
6.3 kVA	160	0 163 55			100	0 153 96	80	4 093 62	16	0 133 16	16	4 078 98	10	0 133 10	10	4 078 96
10 kVA	250	0 173 65			160	0 163 55	125	4 093 64	25	0 133 25	25	4 079 00	16	0 133 16	16	4 078 98
16 kVA									40	0 143 40	40	4 079 02	25	0 133 25	25	4 079 00
25 kVA									63	0 153 63	63	4 079 04	40	0 143 40	40	4 079 02
40 kVA									100	0 153 96	100	4 093 63	63	0 153 63	63	4 079 04
50 kVA									125	0 153 97	125	4 093 64	80	0 153 80	80	4 093 62
63 kVA									160	0 163 55	160	4 200 17	100	0 153 96	100	4 093 63
80 kVA									200	0 168 60	200	4 200 18	125	0 153 97	125	4 093 64
100 kVA									250	0 173 65	250	4 200 19	160	0 163 55	160	4 200 17
125 kVA									315	0 178 70	400	0 255 38	200	0 168 60	200	4 200 18
160 kVA									400	0 178 75	400	0 255 38	250	0 173 65	250	4 200 19
200 kVA									500	0 181 25	630	0 255 40	315	0 178 70	320	0 255 37
250 kVA									630	0 181 30	630	0 255 40	400	0 178 75	400	0 255 38

## Main transformer functions:

### • Changing voltage:



Isolation transformer (basic insulation between primary and secondary)



Auto-transformer (no insulation between primary and secondary)

### • Control circuit power supply



Control transformer (basic insulation between primary and secondary)

### • Protection against electric shock

- Protection against direct and indirect contact by:



Safety isolating transformers (reinforced insulation between primary and secondary, no-load voltage < 50 V)

- Protection against indirect contact by:



Isolating transformers (reinforced insulation between primary and secondary)



Isolating transformers For the supply of medical location (group II)

The transformer function(s) can either be defined by the equipment designer or can be imposed by installation guidelines or the equipment standard

### Definitions:

- Electric shocks: physiological effect resulting from an electrical current through a human or animal body (IEV 195-01-04)
- Direct contact: electric contact of persons or animals with live parts (195-06-03)
- Indirect contact: electric contact of persons or animals with exposed-conductive-parts which have become live under fault conditions (195-06-04)



Power supplies for PLCs and peripheral equipment, and all other uses which need 24 V DC  
 Supplied with an insulated coupling bar for fast connection between the – and T terminals up to 15 A  
 Clip-on only up to 24 W, clip-on or screw fixing up to 120 W  
 Above 120 W: screw fixing  
 Conform to standards IEC and EN 61558-2-6, UL 60950 and CAN/CSA-C22.2 No 60 950.00  
 UL USA and Canada agreements up to 240 W  
 Products suitable for building equipment conforming to standards EN 61131-2, EN 60204 and EN 60439-1

Pack	Cat.Nos	Single-phase power supplies			
		Consisting of: - a safety transformer with interference filtering - double operating terminals - filter capacitors - fused protection in the secondary - a green operating voltage present indicator			
		<b>24 V<sub>DC</sub></b> 230-400 V ± 15 V <sub>~</sub> (primary) / 24 V <sub>DC</sub> (secondary)			
		Output (W)	Current (A)	Terminal capacity Flexible cables	
				Input	Output
1	0 470 21	24	1	6	6
1	0 470 22	60	2.5	6	6
1	0 470 23	120	5	6	6
1	0 470 24	240	10	6	6
1	0 470 25	360	15	6	6
1	0 470 26	600	25	6	10
1	0 470 28	960	40	6	16
1	0 470 29	1200	50	16	16

## Dimensions

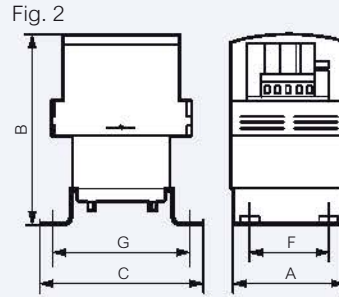
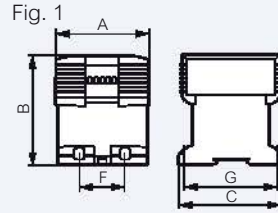

Cat.Nos	Out voltage (V)	Out current (A)	Fig.	Dimensions (mm)			Fixing (mm)			Weight (kg)
				A	B	C	F	G	∅	
0 470 21	24	1	1	68	98	88	-	-	-	1
0 470 22	24	2.5	1	93	121	105	45	94	4.6	2.45
0 470 23	24	5	1	105	135	115	45	104	4.6	3.6
0 470 24	24	10	2	126	186	175	75	150	5.5	6.35
0 470 25	24	15	2	126	206	175	75	150	5.5	7.6
0 470 26	24	25	3	180	238	290	150	105	9	18.1
0 470 28	24	40	4	310	265	478	445	200	7	50
0 470 29	24	50	4	335	315	575	542	200	7	60

Cat.Nos	Primary on-load (A) current		Operating voltages				No-load losses (W)	Total losses at 100% load (W)	Voltage drop %
			Open circuit (V)	On-load (V)	On-load 100 mA and primary voltage + 10 %	Nominal on-load and primary voltage - 15 %			
	at 230 V	at 400 V							
0 470 21	0.18	0.10	29.0	22.8	31.2	20.2	4.4	10.3	27.03
0 470 22	0.47	0.27	27.8	23.3	30.4	20.4	8.3	16.3	19.46
0 470 23	0.88	0.51	27.5	23.2	30.2	20.3	11.4	25.4	18.68
0 470 24	1.88	1.09	27.7	23.5	30.5	20.5	20	45.3	18.20
0 470 25	2.53	1.46	27.5	23.2	30.2	20.2	23	54.7	18.70
0 470 26	4.70	2.70	28.3	24	31.1	20.9	41.3	76.8	17.92
0 470 28	6.20	3.60	28.4	23.2	31.2	20.4	230	340	22.41
0 470 29	7.20	4.10	25.4	23.5	27.9	20.2	194	340	8.09



# P17 TEMPRA PRO

suitable for all environments



### IP44

Sockets for internal and external use, protected against projections of water (but not exposed to direct jets).

### IP66/67

Weatherproof sockets that can withstand temporary immersion (unplug in torrential rain, floods, etc.).

- From 16 to 32 A
- 2 P+E / 3 P+E / 3 P+N+E
- From 100 to 500 V~
- 50/60 Hz
- IK 09 - Polyamide 6
- Conform to IEC 60 309-1 and 2
- Screw connection

100 to 130 V~ 50/60 Hz Consult us

200 to 250 V~ 50/60 Hz

380 to 415 V~ 50/60 Hz

440 to 460 V~ 50/60 Hz Consult us

480 to 500 V~ 50/60 Hz Consult us

### FOUR FUNCTIONS AVAILABLE



Straight plugs



Mobile sockets



Panel mounting sockets



Surface mounting sockets

### QUICK OPENING/CLOSING SYSTEM

Unlocked by pressing with a screwdriver. Marking indicates the location for the locking clip.



Opened by turning the 2 parts in opposite directions.



### 2 MOUNTING POSITIONS

To solve the problem of limited space, the surface mounting sockets offer 2 different mounting positions (5° or 25°) which allow users to adapt to the space available without changing the box.

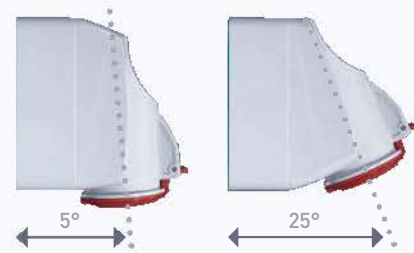

# P 17 Tempra Pro IP 44 - LV 16 and 32 A

## selection chart

		FUNCTIONS								
		SURFACE MOUNTING SOCKETS	PANEL MOUNTING SOCKETS INCLINED OUTLET	PANEL MOUNTING SOCKETS STRAIGHT OUTLET	INTERLOCKED SWITCHED SOCKETS WITH SMALL FLANGE	MOBILE SOCKETS	STRAIGHT PLUGS	ANGLED PLUGS	APPLIANCE INLETS	
Conform to IEC 60309-1 and IEC 60309-2 IP 44 according to IEC 60529 IK 09 according to IEC 62262 Material: polyamide 6 Self-extinguishing: 850 °C (support of active parts) / 650 °C (plastic housing)										
LV										
200 to 250 V <sub>~</sub> 50/60 Hz	16 A	2P+E	5 551 54	5 551 84	0 573 54	0 573 00 <sup>(1)</sup>	5 551 04	5 551 24	0 564 53	0 575 84 <sup>(2)</sup>
		3P+E	5 551 55	5 551 85			5 551 05	5 551 25		0 575 85 <sup>(2)</sup>
		3P+N+E	5 551 56	5 551 86			5 551 06	5 551 26		0 575 86 <sup>(2)</sup>
	32 A	2P+E	5 552 54	5 552 84	0 580 54		5 552 14	5 552 34	0 564 73	0 582 84 <sup>(2)</sup>
		3P+E	5 552 55	5 552 85			5 552 15	5 552 35		
		3P+N+E	5 552 56	5 552 86			5 552 16	5 552 36		0 582 86 <sup>(2)</sup>
380 to 415 V <sub>~</sub> 50/60 Hz	16 A	2P+E	5 551 57				5 551 07	5 551 27		
		3P+E	5 551 58	5 551 88	0 573 58	0 573 01 <sup>(1)</sup>	5 551 08	5 551 28	0 564 57	0 575 88 <sup>(2)</sup>
		3P+N+E	5 551 59	5 551 89	0 573 59	0 573 02 <sup>(1)</sup>	5 551 09	5 551 29	0 564 58	0 575 89 <sup>(2)</sup>
	32 A	2P+E	5 552 57				5 552 17	5 552 37		
		3P+E	5 552 58	5 552 88	0 580 58		5 552 18	5 552 38	0 564 77	0 582 88 <sup>(2)</sup>
		3P+N+E	5 552 59	5 552 89	0 580 59		5 552 19	5 552 39	0 564 78	0 582 89 <sup>(2)</sup>
440 to 460 V <sub>~</sub> 50/60 Hz	16 A	3P+E	5 551 60	5 551 90			5 551 10	5 551 30		
	32 A	3P+E	5 552 60	5 552 90			5 552 20	5 552 40		

1: Can be fitted only on faceplate Cat.No 0 577 23 (p. 336) - 2: Protection covers not supplied (p. 326)

Other voltages available on request  
**Please, consult us**



# P 17 Tempra Pro IP 66/67 - LV 16, 32, 63 and 125 A

## selection chart

		FUNCTIONS							
		SURFACE MOUNTING SOCKETS	PANEL MOUNTING SOCKETS	INTERLOCKED SWITCHED SOCKETS WITH SMALL FLANGE	MOBILE SOCKETS	STRAIGHT PLUGS	ANGLED PLUGS	APPLIANCE INLETS	
Conform to IEC 60309-1 and IEC 60309-2 IP 44 according to IEC 60529 IK 09 according to IEC 62262 Material: polyamide 6 Self-extinguishing: 850 °C (support of active parts) / 650 °C (plastic housing)									
LV									
200 to 250 V~ 50/60 Hz	16 A	2P+E	5 553 54	5 553 84	0 573 20 <sup>(1)(2)</sup>	5 553 04	5 553 24	0 565 03	0 568 03
		3P+E	5 553 55	5 553 85		5 553 05	5 553 25		0 568 04
		3P+N+E	5 553 56	5 553 86		5 553 06	5 553 26		
	32 A	2P+E	5 554 54	5 554 84		5 554 14	5 554 34	0 565 23	0 568 23
		3P+E	5 554 55	5 554 85		5 554 15	5 554 35		
		3P+N+E	5 554 56	5 554 86		5 554 16	5 554 36		
	63 A	2P+E	0 587 40	0 587 20		0 587 10	0 587 00		0 587 30
		3P+E	0 587 41	0 587 21		0 587 11	0 587 01		
		3P+N+E	0 587 42	0 587 22		0 587 12	0 587 02		
380 to 415 V~ 50/60 Hz	16 A	3P+E	5 553 58	5 553 88	0 573 21 <sup>(1)(2)</sup>	5 553 08	5 553 28		0 568 07
		3P+N+E	5 553 59	5 553 89	0 573 22 <sup>(1)(2)</sup>	5 553 09	5 553 29		0 568 08
	32 A	3P+E	5 554 58	5 554 88		5 554 18	5 554 38		0 568 27
		3P+N+E	5 554 59	5 554 89		5 554 19	5 554 39	0 565 28	0 568 28
	63 A	3P+E	0 587 44	0 587 24		0 587 14	0 587 04		0 587 34
		3P+N+E	0 587 45	0 587 25		0 587 15	0 587 05		0 587 35
	125 A	3P+E	0 591 06	0 591 16		0 591 36	0 591 26		0 591 46
		3P+N+E	0 591 07	0 591 17		0 591 37	0 591 27		0 591 47
	440 V~ 50/60 Hz for refrigerated containers	32 A	3P+E		5 554 91		5 554 21	5 554 41	

1: IP 55 - 2: Can be fitted only on faceplate Cat.No 0 577 23 (p. 336)

Other voltages available on request  
**Please, consult us**

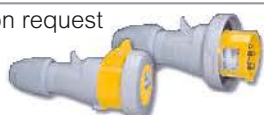

# P 17 Tempra Pro IP 44 - LV 16 and 32 A

sockets, plugs, mobile sockets, appliance inlets and interlocked switched sockets



5 552 58



5 551 88



5 551 08



5 551 28

Technical characteristics p. 330

## Pack Cat.Nos Surface mounting sockets

Pack	Cat.Nos		Voltage	Configuration
	16 A	32 A		
1015	5 551 54	5 552 54	200/250 V~	2P+E
	5 551 55	5 552 55		3P+E
	5 551 56	5 552 56		3P+N+E
5	5 551 57	5 552 57	380/415 V~	2P+E
	5 551 58	5 552 58		3P+E
	5 551 59	5 552 59		3P+N+E

Two possible angles (5° or 25°)

## Pack Cat.Nos Mobile sockets

Pack	Cat.Nos		Voltage	Configuration
	16 A	32 A		
10	5 551 04	5 552 14	200/250 V~	2P+E
	5 551 05	5 552 15		3P+E
	5 551 06	5 552 16		3P+N+E
5	5 551 07	5 552 17	380/415 V~	2P+E
	5 551 08	5 552 18		3P+E
	5 551 09	5 552 19		3P+N+E

Cable clamping and closing without screws  
Supplied unlocked

## Panel mounting sockets inclined outlet

Pack	Cat.Nos		Voltage	Configuration
	16 A	32 A		
10	5 551 84	5 552 84	200/250 V~	2P+E
	5 551 85	5 552 85		3P+E
	5 551 86	5 552 86		3P+N+E
10	5 551 88	5 552 88	380/415 V~	3P+E
	5 551 89	5 552 89		3P+N+E

Can be fixed on plain faceplates or pre-drilled (p. 336) and on flush mounting boxes (p. 327)

## Straight plugs

Pack	Cat.Nos		Voltage	Configuration
	16 A	32 A		
10	5 551 24	5 552 34	200/250 V~	2P+E
	5 551 25	5 552 35		3P+E
	5 551 26	5 552 36		3P+N+E
5	5 551 27	5 552 37	380/415 V~	2P+E
	5 551 28	5 552 38		3P+E
	5 551 29	5 552 39		3P+N+E

Cable clamping and closing without screws  
Supplied unlocked

## Panel mounting sockets straight outlet small flange

Pack	Cat.Nos		Voltage	Configuration
	16 A	32 A		
5	0 573 54	0 580 54	200/250 V~	2P+E
	0 573 58	0 580 58		3P+E
	0 573 59	0 580 59		3P+N+E

Can be fixed only on plain faceplates  
Cat.Nos 0 577 15/16 (p. 336)

## Phase inverter plugs

Pack	Cat.Nos		Voltage	Configuration
	16 A	32 A		
5	0 574 40	0 581 40	380/415 V~	3P+E
	0 574 41	0 581 41		3P+N+E

Straight plugs for changing rotation direction of a 3-phase electric motor

## Interlocked switched sockets with small flange

Pack	Cat.Nos		Voltage	Configuration
	IP 44	IP 55		
1	0 573 00	0 573 20	200/250 V~	2P+E
	0 573 01	0 573 21		3P+E
1	0 573 02	0 573 22	380/415 V~	3P+N+E

Dimensions: 125 x 105 mm  
Can be fixed only on faceplate  
Cat.No 0 577 23 (p. 336)

## Appliance inlets

Pack	Cat.Nos		Voltage	Configuration
	16 A	32 A		
5	0 575 84	0 582 84	200/250 V~	2P+E
	0 575 85	0 582 85		3P+E
	0 575 86	0 582 86		3P+N+E
5	0 575 88	0 582 88	380/415 V~	3P+E
	0 575 89	0 582 89		3P+N+E

IP 44

## Protection covers

Pack	Material	Cat.Nos	Voltage	Configuration
10	Rubber	0 521 25	200/250 V~	2P+E - 16 A
		0 521 26		3P+E - 16 A
		0 521 27		3P+N+E - 16 A / 2P+E and 3P+E - 32 A
		0 527 99		3P+N+E - 32 A

IP 67  
IP 44 maintained with the plug inserted

For plugs and appliance inlets:  
2P+E - 16 A  
3P+E - 16 A  
3P+N+E - 16 A / 2P+E and 3P+E - 32 A  
3P+N+E - 32 A



## P 17 Tempra - domestic pin configuration 16 A - 250 V~

## P 17 Tempra IP 44 - ELV 16 and 32 A



Technical characteristics p. 331

Technical characteristics p. 332

Pack	Cat.Nos	Panel mounting sockets
		Domestic pin configuration German standard sockets IP 54 cover closed - IP 44 connected IK 09 according to IEC 62262 and EN 62262 2P+E 250 V~ Material: plastic Self-extinguishing: 850 °C
		<b>Panel mounting sockets with small flange</b> Can be fixed only on plain faceplates Cat.Nos 0 577 15/16 (p. 336)
20	0 576 69	White panel mounting sockets
20	0 576 75	Blue panel mounting sockets with shutters
		<b>Panel mounting sockets</b> Can be fixed on pre-cut or plain faceplate for combined units (p. 336), flush-mounting boxes Cat.Nos 0 577 21/22
20	0 576 72	Blue panel mounting sockets
20	0 576 76	Blue panel mounting sockets with shutters
		<b>Panel mounting adaptor</b>
8	0 539 48	Accepts Arteor and Mosaic mechanisms 2 modules (except particular prominence)
		<b>Adaptor</b>
10	0 521 05	16 A - 250 V~ IEC input 2P+E Output: empty model to be equipped with Mosaic mechanism all standards
		<b>Flush-mounting boxes</b>
		IP 55 For panel mounting sockets inclined outlet installation (IP 44 or IP 66/67) Flush mounting boxes with faceplates
3	0 577 21	For 2 panel mounting sockets With single fixing centres 70 x 70 mm - 16 A
3	0 577 22	For 1 panel mounting socket With single fixing centres 70 x 70 mm - 16 or 32 A (32 A to be fixed horizontally)

Pack	Cat.Nos	Surface mounting sockets
5	16 A   32 A 0 552 06   0 552 56	20/25 V~ 2P
		<b>Panel mounting sockets</b>
5	16 A   32 A 0 552 45   0 552 95	20/25 V~ 2P
		<b>Straight plugs</b>
5	16 A   32 A 0 552 21   0 552 71	20/25 V~ 2P
		<b>Mobile sockets</b>
5	16 A   32 A 0 552 31   0 552 81	20/25 V~ 2P
		<b>Appliance inlets</b>
5	16 A   32 A 0 552 41   0 552 91	20/25 V~ 2P



5 554 58



5 553 28



6 571 06

Technical characteristics p. 333

**Surface mounting sockets**

Pack	Cat.Nos		
	16 A	32 A	Two possible angles (5° or 25°)
5	5 553 54	5 554 54	200/250 V~ 2P+E
5	5 553 55	5 554 55	3P+E
5	5 553 56	5 554 56	3P+N+E
			380/415 V~
5	5 553 58	5 554 58	3P+E
5	5 553 59	5 554 59	3P+N+E

Two possible angles (5° or 25°)

200/250 V~

2P+E

3P+E

3P+N+E

380/415 V~

3P+E

3P+N+E

**Panel mounting sockets**

Pack	Cat.Nos		
	16 A	32 A	Can be fixed on the faceplates (p. 336)
5	5 553 84	5 554 84	200/250 V~ 2P+E
5	5 553 85	5 554 85	3P+E
5	5 553 86	5 554 86	3P+N+E
			380/415 V~
5	5 553 88	5 554 88	3P+E
5	5 553 89	5 554 89	3P+N+E

Can be fixed on the faceplates (p. 336)

200/250 V~

2P+E

3P+E

3P+N+E

380/415 V~

3P+E

3P+N+E

**Mobile sockets**

Pack	Cat.Nos		
	16 A	32 A	Supplied unlocked
5	5 553 04	5 554 14	200/250 V~ 2P+E
5	5 553 05	5 554 15	3P+E
5	5 553 06	5 554 16	3P+N+E
			380/415 V~
5	5 553 08	5 554 18	3P+E
5	5 553 09	5 554 19	3P+N+E

Supplied unlocked

200/250 V~

2P+E

3P+E

3P+N+E

380/415 V~

3P+E

3P+N+E

**Straight plugs**

Pack	Cat.Nos		
	16 A	32 A	Supplied unlocked
5	5 553 24	5 554 34	200/250 V~ 2P+E
5	5 553 25	5 554 35	3P+E
5	5 553 26	5 554 36	3P+N+E
			380/415 V~
5	5 553 28	5 554 38	3P+E
5	5 553 29	5 554 39	3P+N+E

Supplied unlocked

200/250 V~

2P+E

3P+E

3P+N+E

380/415 V~

3P+E

3P+N+E

**Appliance inlets**

Pack	Cat.Nos		
	16 A	32 A	200/250 V~
5	0 568 03	0 568 23	2P+E
5	0 568 04	-	3P+E
			380/415 V~
5	0 568 07	0 568 27	3P+E
5	0 568 08	0 568 28	3P+N+E

200/250 V~

2P+E

3P+E

380/415 V~

3P+E

3P+N+E

**Combined unit, plug and mobile socket for refrigerated containers**

Pack	Cat.Nos	
1	6 571 06	32 A - 440 V~ - 50/60 Hz - 3P+E - 3 hours IK 09 Plastic body and cover - Stainless steel screws Combined unit with interlocked switched socket - Double mechanical interlock - Cable glands are not supplied
5	5 554 91	Panel mounting socket
5	5 554 21	Mobile socket With cable grip Ø12 to 21.5 mm
5	5 554 41	Straight plug With cable grip Ø12 to 21.5 mm

## P 17 Tempra IP 66/67 - LV 63 and 125 A



Technical characteristics p. 334-335

### Pack Cat.Nos **Surface mounting sockets**

2	63 A		125 A	<b>200/250 V~</b>
	0 587 40			<b>380/415 V~</b>
2	1	0 587 44	0 591 06	3P+E
		0 587 45	0 591 07	3P+N+E

### **Panel mounting sockets**

Can be fixed on the faceplates  
Cat.Nos 0 577 17/19 (p. 336)

2	63 A		125 A	<b>200/250 V~</b>
	0 587 20			<b>380/415 V~</b>
2	1	0 587 24	0 591 16	3P+E
		0 587 25	0 591 17	3P+N+E

### **Straight plugs**

2	63 A		125 A	<b>200/250 V~</b>
	0 587 00			<b>380/415 V~</b>
2	1	0 587 04	0 591 26	3P+E
		0 587 05	0 591 27	3P+N+E

### **Mobile sockets**

2	63 A		125 A	<b>200/250 V~</b>
	0 587 10			<b>380/415 V~</b>
2	1	0 587 14	0 591 36	3P+E
		0 587 15	0 591 37	3P+N+E

### **Appliance inlets**

2	63 A		125 A	<b>200/250 V~</b>
	0 587 30			<b>380/415 V~</b>
2	1	0 587 34	0 591 46	3P+E
		0 587 35	0 591 47	3P+N+E

## P 17 WORKSITES COMBINED UNITS

# Power supply made easy



- Provide temporary power supplies on building sites and for events
- 2 types of worksites combined units:
  - individual units (ready to use or to be equipped)
  - floor cabinets (to be equipped)
- Can take P17 Tempra Pro panel mounting sockets, Osmoz control units, Mosaic or Arteor sockets outlets (via the dedicated adaptor)
- Easy to hang on a wall without having to open the unit



## CUSTOM MADE RANGES

Custom made P17 Tempra Pro power connectors and combined units available on request

Ask for your enquiry forms in order to define product specification

## Characteristics

Terminal connection:

- Panel and surface mounting sockets

16 A: max. 1 x 4 mm<sup>2</sup> rigid

32 A: max. 1 x 10 mm<sup>2</sup> rigid

- Appliance inlets:

16 A: max. 1 x 2.5 mm<sup>2</sup> rigid

32 A: max. 1 x 6 mm<sup>2</sup> rigid

- Plugs and mobile sockets:

16 A: max. 1 x 2.5 mm<sup>2</sup> flexible

32 A: max. 1 x 6 mm<sup>2</sup> flexible

IP 44 according to IEC and EN 60529

IK 08 according to EN 50102 for interlocked switched sockets with small flange

IK 09 according to IEC 62262 and EN 62262

Material: polyamide 6

Self-extinguishing: 850 °C (support of active parts) / 650 °C (plastic housing)

- 25 °C to + 40 °C according to IEC 60309-1

## Dimensions

### Surface mounting sockets (p. 326)

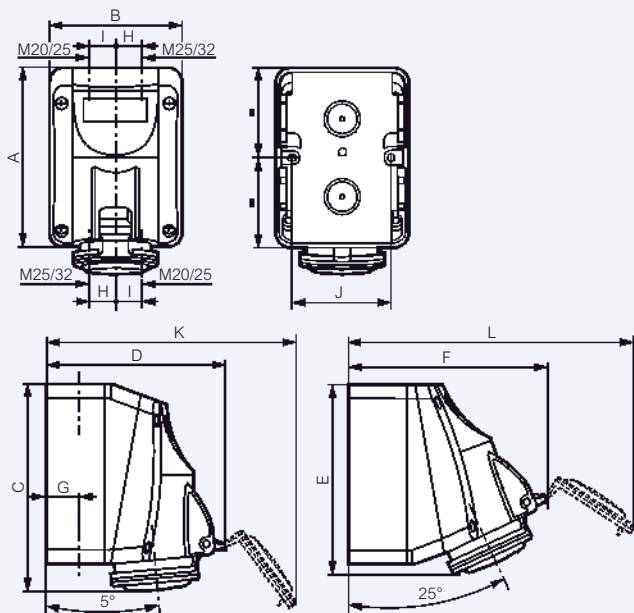

	A	B	C	D	E	F	G	H	I	J	K	L
<b>LV 16 A</b>												
2P+E	125	93	147	126	138	139	22	17	20	70	176	195
3P+E	125	93	147	134	138	147	22	17	20	70	190	210
3P+N+E	125	93	147	140	138	153	22	17	20	70	201	221
<b>LV 32 A</b>												
2P+E	150	113	174	156	163	172	28	22	26	90	220	245
3P+E	150	113	174	156	163	172	28	22	26	90	220	245
3P+N+E	150	113	174	162	163	177	28	22	26	90	230	256

### Panel mounting socket straight outlet small flange (p. 326)

Cat.No 0 573 54

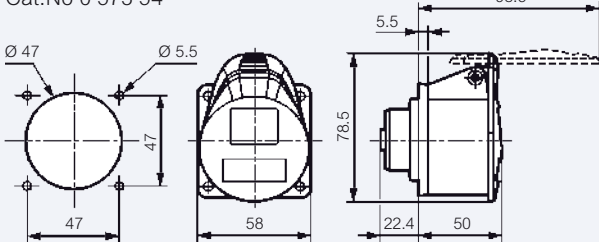

Weight (kg) = 0.105

### Panel mounting sockets inclined outlet (p. 326)

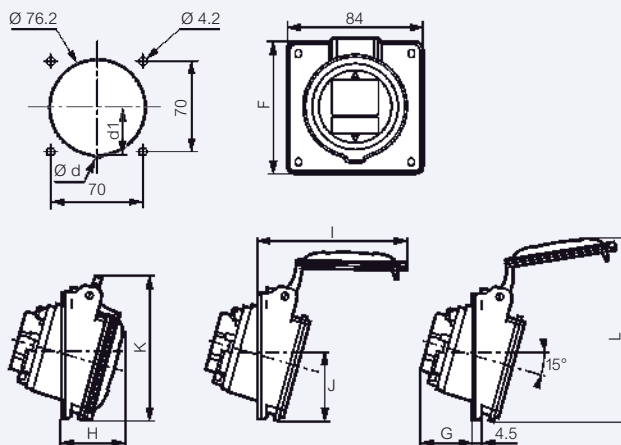

	Ød	d1	F	G	H	I	J	K	L
<b>LV 16 A</b>									
2P+E	-	-	84	33.5	37.5	85	42	88.5	112.5
3P+E	-	-	84	35.5	38.5	93	42	91.5	118.5
3P+N+E	-	-	84	36.5	39.5	100	43.3	97	123.5
<b>LV 32 A</b>									
2P+E	-	-	94	41.5	45.5	110	47	102	131
3P+E	-	-	94	42.5	46.5	117	47	107.5	138

### Appliance inlets (p. 326)

Cat.Nos 0 575 84/88/89 and 0 582 84/88/89

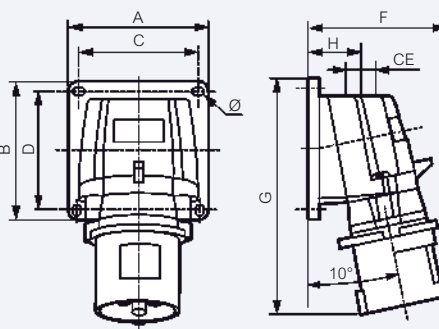

	Weight (kg)	A	B	C	D	F	G	H	CE	Ø
<b>LV 16 A</b>										
2P+E	0.168	84	84	72	72	77	126	34	M20	4.3
3P+E	0.232	84	84	72	72	84	134	34	M20	4.3
3P+N+E	0.256	84	84	72	72	91	141	34	M20	4.3
<b>LV 32 A</b>										
2P+E	0.325	110	110	98	98	96	168	39	M25	5.3
3P+E	0.364	110	110	98	98	102	168	39	M25	5.3

### Interlocked switched sockets with small flange (p. 326)

Cat.Nos 0 573 00/01/02 and 0 573 20/21/22

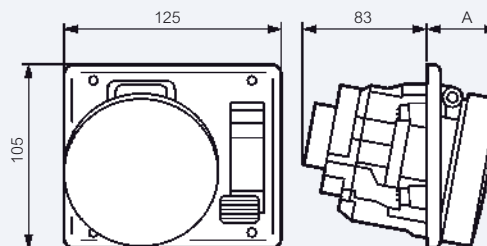

	16 A	IP	A	IP	A
2P+E	44	38	55	45	
3P+E	44	38	55	45	
3P+N+E	44	38	55	45	

## P 17 Tempra Pro IP 44 - LV 16 and 32 A

mobile products

## P 17 Tempra domestic pin configuration

16 A - 250 V

### Dimensions

#### Straight plugs (p. 326)

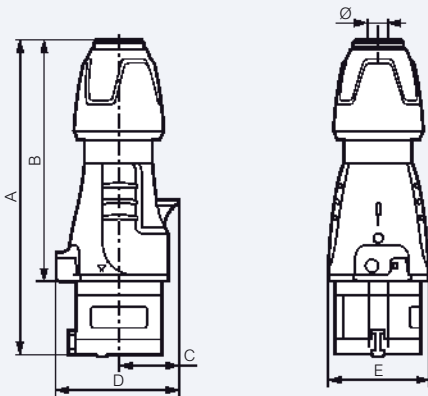

	A	B	C	D	E	Ø
<b>LV 16 A</b>						
2P+E	146 to 157	109.5 to 120.5	30	61	50	6.5 to 14
3P+E	146 to 157	109.5 to 120.5	34	67	55	7.10 to 15.5
3P+N+E	163 to 176	126.5 to 139.5	38	76	65	8 to 20
<b>LV 32 A</b>						
2P+E	172 to 185	127 to 140	40	78	65	8 to 20
3P+E	172 to 185	127 to 140	40	78	65	8 to 20
3P+N+E	179 to 189	133 to 143	45	86	71	11.9 to 22.2

#### Mobile sockets (p. 326)

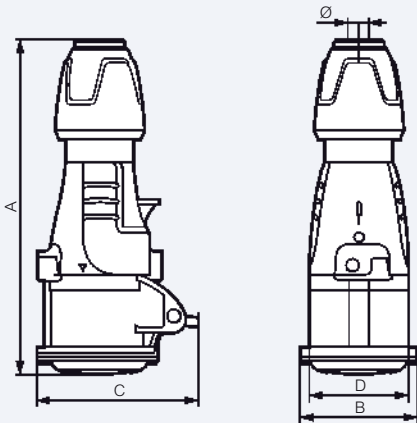

	A	B	C	D	Ø
<b>LV 16 A</b>					
2P+E	156 to 167	59	81	50	6.5 to 14
3P+E	157 to 168	65	88	55	7.10 to 15.5
3P+N+E	175 to 188	72	94	65	8 to 20
<b>LV 32 A</b>					
2P+E	184 to 197	73	99	65	8 to 20
3P+E	184 to 197	73.5	99	65	8 to 20
3P+N+E	190 to 203	79.5	105	71	11.9 to 22.2

### Dimensions

#### Domestic pin configuration sockets (p. 327)

Cat.Nos 0 576 69/75

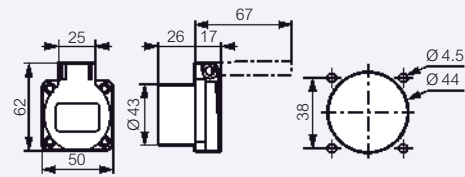

Cat.Nos 0 576 72/76

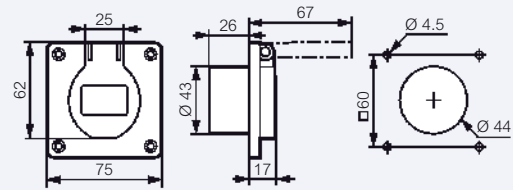

#### Adaptor 16 A - 230 V (p. 327)

Cat.No 0 521 05

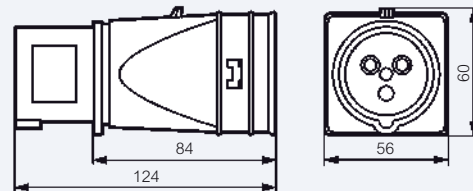

#### Flush mounting boxes (p. 327)

Cat.No 0 577 21

Cat.No 0 577 22

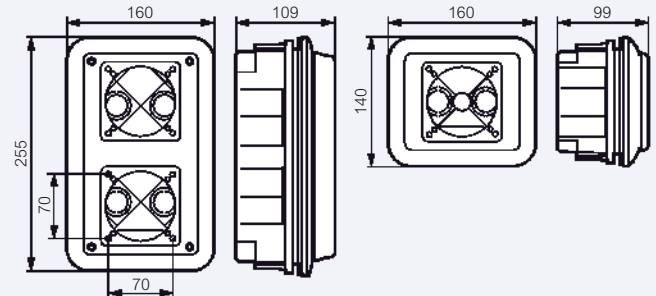

#### Panel mounting adaptor (p. 327)

Cat.No 0 539 48

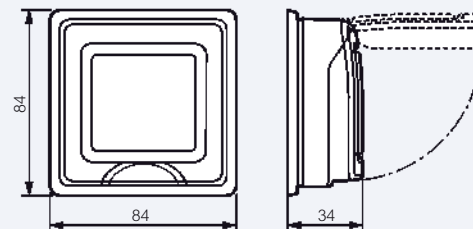

## P 17 Tempra IP 44 - ELV 16 and 32 A

### ■ Characteristics

Terminal connection:  
 Max. 1 x 10 mm<sup>2</sup> (rigid for fixed products flexible for mobile products)  
 IP 44 according to IEC 60529 and EN 60529  
 IK 09 according to IEC 62262 and EN 62262  
 Material: plastic  
 Self-extinguishing: 850 °C (support of active parts) / 650 °C (plastic housing)  
 Temp. rating: - 25 °C to + 40 °C  
 Conform to IEC 60309-1 / IEC 60309-2 and EN 60309-1 / EN 60309-2

### ■ Dimensions

#### Surface mounting sockets (p. 327)

Cat.Nos 0 552 06/56

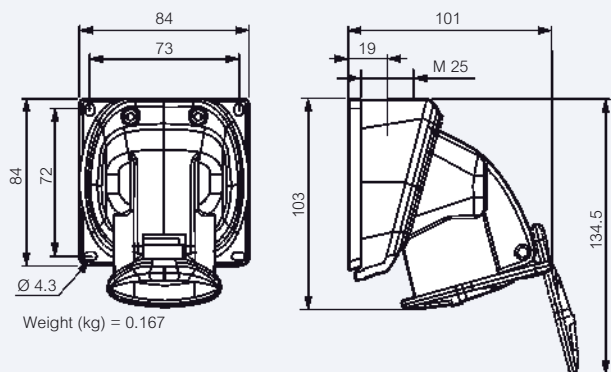

#### Panel mounting sockets (p. 327)

Cat.Nos 0 552 45/95

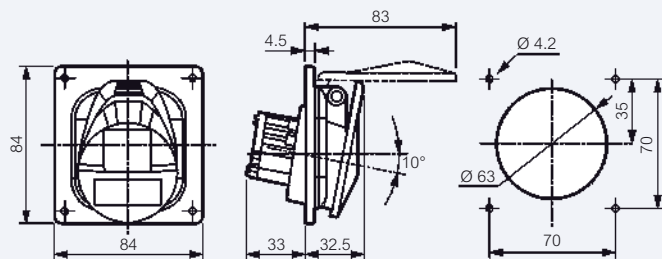

#### Appliance inlets (p. 327)

Cat.Nos 0 552 41/91

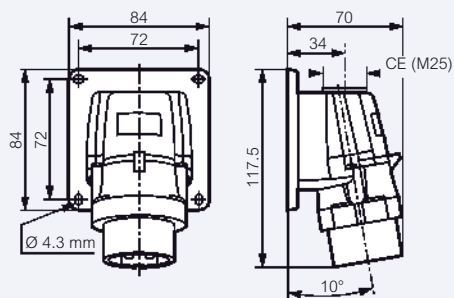

### ■ Dimensions ELV 16 and 32 A

#### Straight plugs (p. 327)

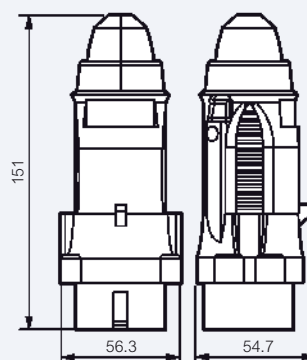

#### Mobile sockets (p. 327)

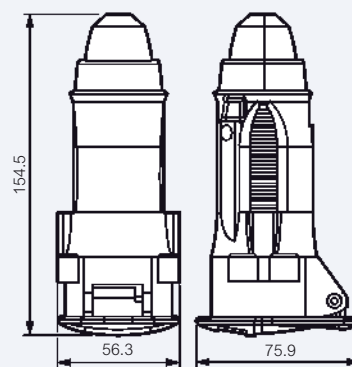

# P 17 Tempra Pro IP 66/67 - LV 16 and 32 A

## Characteristics

Terminal connection:

- Panel and surface mounting sockets
- 16 A: max. 1 x 4 mm<sup>2</sup> rigid - 32 A: max. 1 x 10 mm<sup>2</sup> rigid
- Plugs, mobile sockets:
- 16 A: max. 1 x 2,5 mm<sup>2</sup> flexible - 32 A: max. 1 x 6 mm<sup>2</sup> flexible
- Appliance inlets:

16 A: max. 1 x 2.5 mm<sup>2</sup> rigid - 32 A: max. 1 x 6 mm<sup>2</sup> rigid  
 IP 66/67 according to IEC 60529 and EN 60529

IK 09 according to IEC 62262 and EN 62262

Material: polyamide 6

Self-extinguishing: 850 °C (support of active parts) / 650 °C (plastic housing)

Temp. rating: - 25 °C to + 40 °C

Conform to IEC 60309-1 and IEC 60309-2

## Dimensions

Surface mounting sockets (p. 328)

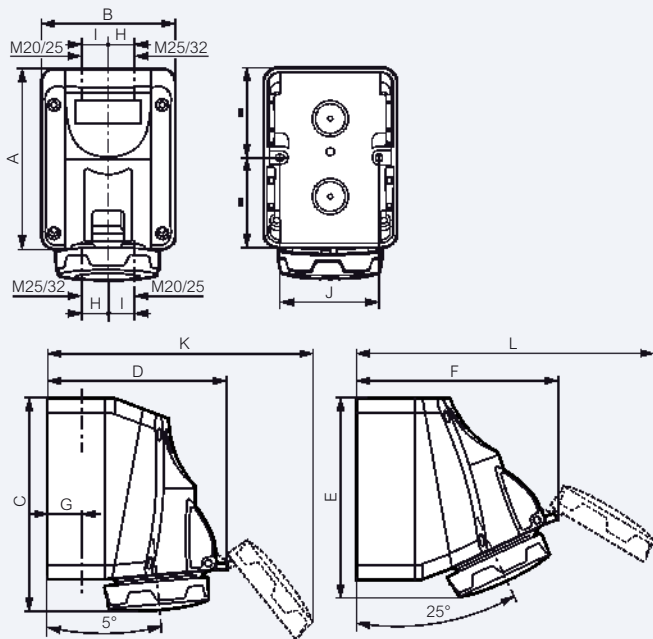

	A	B	C	D	E	F	G	H	I	J	K	L
<b>LV 16 A</b>												
2P+E	125	93	144	125	131	137	22	17	20	70	178	200
3P+E	125	93	144	133	131	145	22	17	20	70	194	215
3P+N+E	125	93	144	139	131	150	22	17	20	70	205	227
<b>LV 32 A</b>												
2P+E	150	113	171	155	156	170	28	22	26	90	224	250
3P+E	150	113	171	161	156	175	28	22	26	90	231	260
3P+N+E	150	113	171	161	156	175	28	22	26	90	231	260

Panel mounting sockets (p. 328)

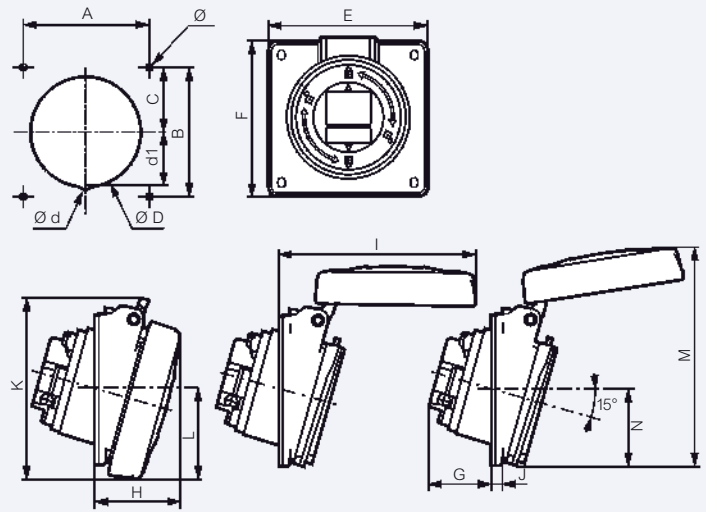

	Dimensions (mm)																
	A	B	C	∅D	∅d	d1	E	F	G	H	I	J	K	L	M	N	∅
<b>LV 16 A</b>																	
2P+E	70	70	35	76.2	-	-	84	84	33.5	42	94	4.5	88	42.5	114	42	4.2
3P+E	70	70	35	76.2	-	-	84	84	35.5	43	101	4.5	94.5	46	118	42	4.2
3P+N+E	70	70	35	76.2	-	-	84	84	36.5	44	108.5	4.5	101	50	123	42.5	4.2
<b>LV 32 A</b>																	
2P+E/ 3P+E	70	70	35	76.2	-	-	84	94	41.5	50.5	118	4.5	105.5	54.5	129.5	47.5	4.2
3P+N+E	70	70	35	76.2	8	36	84	94	42.5	51.5	124.5	4.5	112	57.5	137	51	4.2

Appliance inlets (p. 328)

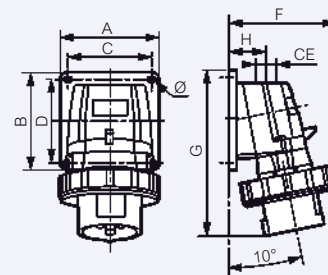

	Weight (kg)	A/B	C/D	F	G	H	CE	∅
<b>LV 16 A</b>								
2P+E	0.188	84	72	87	126	34	M 20	4.3
3P+E	0.257	84	72	95	134	34	M 20	4.3
3P+N+E	0.297	84	72	100	141	34	M 20	4.3
<b>LV 32 A</b>								
2P+E	0.370	110	98	107	168	39	M 25	5.3
3P+E	0.413	110	98	113	168	39	M 25	5.3

## Dimensions

Straight plugs (p. 328)

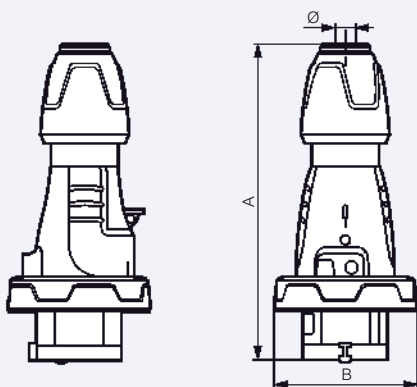

	A	B	Ø
<b>LV 16 A</b>			
2P+E	146 to 157	72.5	6.5 to 14
3P+E	146 to 157	80.5	7.10 to 15.5
3P+N+E	163 to 176	89	8 to 20
<b>LV 32 A</b>			
2P+E	172 to 185	93	8 to 20
3P+E	172 to 185	93	8 to 20
3P+N+E	179 to 189	100	11.9 to 22.2

Mobile sockets (p. 328)

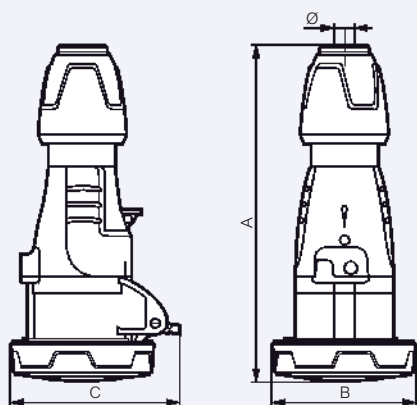

	A	B	C	Ø
<b>LV 16 A</b>				
2P+E	159 to 170	72.5	86	6.5 to 14
3P+E	159 to 170	80.5	93	7.1 to 15.5
3P+N+E	179 to 190	89	100	8 to 20
<b>LV 32 A</b>				
2P+E	187 to 200	93	104	8 to 20
3P+E	187 to 200	93	104	8 to 20
3P+N+E	192 to 205	100	110.5	11.9 to 22.2

## Characteristics

Terminal connection:

- Panel and surface mounting sockets  
63 A: max. 1 x 25 mm<sup>2</sup> rigid - 125 A: max. 1 x 70 mm<sup>2</sup> rigid
  - Appliance inlets:  
63 A: max. 1 x 16 mm<sup>2</sup> rigid - 125 A: max. 1 x 50 mm<sup>2</sup> rigid
  - Plugs and mobile sockets:  
63 A: max. 1 x 16 mm<sup>2</sup> flexible - 125 A: max. 1 x 50 mm<sup>2</sup> flexible
- IP 66/67 according to IEC 60529 and EN 60529  
IK 09 according to IEC 62262 and EN 62262  
Material: plastic  
Self-extinguishing: 850 °C (support of active parts) / 650 °C (plastic housing)  
Temp. rating: - 25 °C to + 40 °C. According to IEC 60309-1 and IEC 60309-2

## Dimensions

Surface mounting sockets (p. 329)

Cat.Nos 0 587 40/44/45

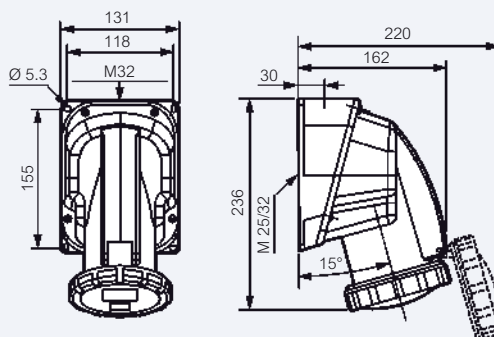

	Weight (kg)
3P+E	0.900
3P+N+E	0.950

Panel mounting sockets (inclined outlet) (p. 329)

Cat.Nos 0 587 20/24/25

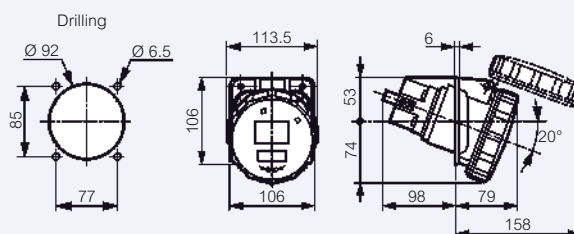

	Weight (kg)
3P+E	0.710
3P+N+E	0.770

Appliance inlets (p. 329)

Cat.Nos 0 587 30/34/35

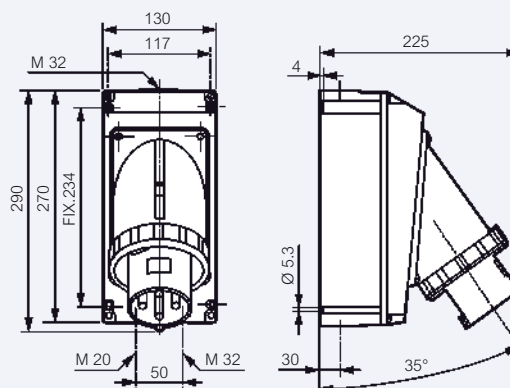

	Weight (kg)
3P+E	1.540
3P+N+E	1.610



## P 17 Tempra IP 66/67 - LV 125 A

## P 17 Tempra IP 66/67 - LV 63 and 125 A

mobile products

### Dimensions

Surface mounting sockets (p. 329)

Cat.Nos 0 591 06/07

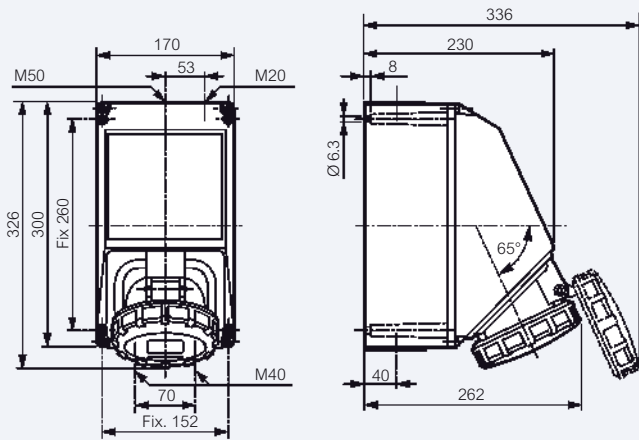

	Weight (kg)
3P+E	2.600
3P+N+E	2.730

Surface mounting sockets (p. 329)

Cat.Nos 0 591 16/17

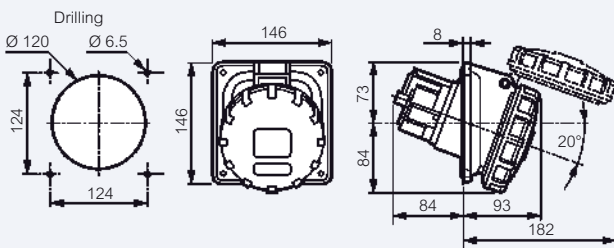

	Weight (kg)
3P+E	1.000
3P+N+E	1.200

Appliance inlets (p. 329)

Cat.Nos 0 591 46/47

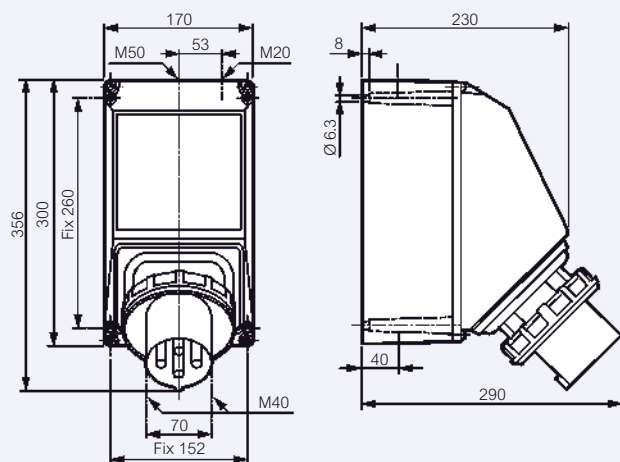

### Dimensions LV 63 A

Straight plugs (p. 329)

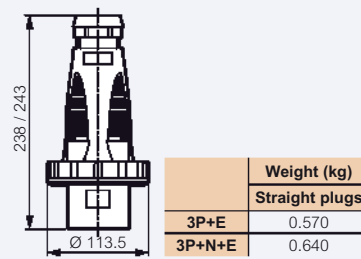

	Weight (kg)
Straight plugs	
3P+E	0.570
3P+N+E	0.640

Mobile sockets (p. 329)

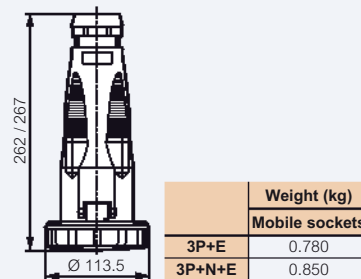

	Weight (kg)
Mobile sockets	
3P+E	0.780
3P+N+E	0.850

### Dimensions LV 125 A

Straight plugs (p. 329)

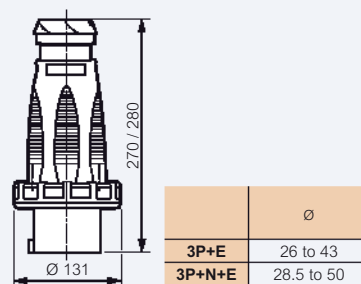

	Ø
3P+E	26 to 43
3P+N+E	28.5 to 50

Mobile sockets (p. 329)

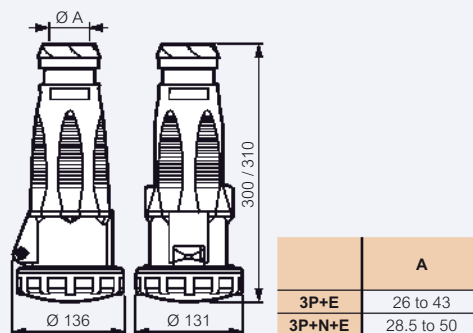

	A
3P+E	26 to 43
3P+N+E	28.5 to 50

# P17 Tempra combined units to be composed

- IK 08 according to IEC 62262
- Self-extinguishing: 650 °C
- Max. IP 66



Bases and faceplates dimensions p. 338

## Example of combined unit configuration

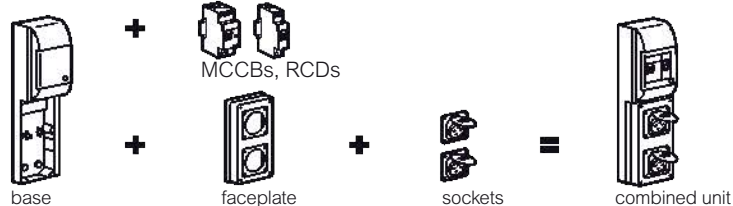

## COMBINED UNITS HEIGHT 220 MM TO 441 MM

### BASES FOR 220 x 125 MM FACEPLATES - MAX IP 66

Surface mounting box	Base up to 2 sockets 16 A	Base up to 4 sockets 16 A	Base up to 6 sockets 16 A				
220 x 125 mm <sup>(4)</sup>	371 x 125 mm <sup>(4)</sup> Rail 5 modules 17.5 mm	441 x 265 mm <sup>(4)</sup> Rail 12 modules 17.5 mm	441 x 405 mm <sup>(4)</sup> Rail 18 modules 17.5 mm				
Pack	Cat.No	Pack	Cat.No	Pack	Cat.No	Pack	Cat.No
1	0 577 10	1	0 589 38	1	0 577 05 <sup>(7)</sup>	1	0 577 06 <sup>(7)</sup>

### 220 X 125 MM FACEPLATES

1 socket 16 or 32 A	2 sockets 16 A	1 socket 63 A	Plain plate				
Pack	Cat.No	Pack	Cat.No	Pack	Cat.No	Pack	Cat.No
5	0 577 12	5	0 577 13 <sup>(1)</sup>	2	0 577 17	5	0 577 15

## COMBINED UNITS HEIGHT 280 MM TO 501 MM

### BASES FOR 280 x 125 MM FACEPLATES - MAX IP 66

Surface mounting box	Base up to 3 sockets 16 A	Base up to 6 sockets 16 A	Base up to 9 sockets 16 A				
280 x 125 mm <sup>(4)</sup>	421 x 125 mm <sup>(4)</sup> Rail 5 modules 17.5 mm	501 x 265 mm <sup>(4)</sup> Rail 12 modules 17.5 mm	501 x 405 mm <sup>(4)</sup> Rail 18 modules 17.5 mm				
Pack	Cat.No	Pack	Cat.No	Pack	Cat.No	Pack	Cat.No
3	0 577 11	1	0 577 20	1	0 577 03 <sup>(7)</sup>	1	0 577 04 <sup>(7)</sup>

### 280 x 125 MM FACEPLATE

2 sockets 16 or 32 A	2 interlocked switched sockets 16 A (p. 330)	1 socket 16 or 32 A and 1 socket 63 A	3 sockets 16 A <sup>(2)</sup>	Plain plate					
Pack	Cat.No	Pack	Cat.No	Pack	Cat.No	Pack	Cat.No		
4	0 577 18 <sup>(1)</sup>	1	0 577 23	2	0 577 19 <sup>(1)</sup>	4	0 577 14 <sup>(1)</sup>	4	0 577 16

1: Supplied with blanking plate - 2: To be fixed horizontally except 16 A domestic pin sockets, vertically (IP 44 - connected) - 3: IP 54 cover closed - IP 44 connected  
4: External dimensions: H x W - 5: Interlocked switched socket with small flange - 6: IP 55 - Interlocked switched socket with small flange - 7: Can be used with the wall mounting lugs Cat.No 0 019 69 (p. 240)



0 577 04 with emergency stop button, appliance inlet and interlocked switched sockets



0 577 20 with interlocked switched sockets

### EXAMPLE OF SOCKETS

ELV (p. 331)			IP 44		
20/25 V~	16 A	2P	0 552 45		
	32 A	2P	0 552 95		
Domestic pin (p. 331)			IP 54 <sup>(3)</sup>		
250 V	16 A	2P+E	0 576 72/76		
LV (p. 328 to 333)			IP 44		
200/250 V~	16 A	2P+E	5 551 84	5 553 84	
	32 A	2P+E	5 552 84	5 554 84	
	63 A	2P+E	-	0 587 20	
380/415 V~	16 A	3P+E	5 551 88	5 553 88	
		3P+N+E	5 551 89	5 553 89	
	32 A	3P+E	5 552 88	5 554 88	
		3P+N+E	5 552 89	5 554 89	
		63 A	3P+E	-	
3P+N+E	-		0 587 25		

### Examples of most common combinations with bases for 220 x 125 mm faceplates

Base	Total number of sockets on the base	Socket combination	Face plate according to the socket intensity		
			16 A	32 A	63 A
0 577 10 or 0 589 38	1	1 x 16 A or 1 x 32 A or 1 x 63 A	0 577 12	0 577 12	0 577 17
	2	2 x 16 A	0 577 13	-	-
0 577 05	2	2 x 16 A or 2 x 32 A or 2 x 63 A	0 577 12 x 2	0 577 12 x 2	0 577 17 x 2
		1 x 16 A + 1 x 32 A	0 577 12	0 577 12	-
		1 x 16 or 32 A + 1 x 63 A	0 577 12		0 577 17
	3	3 x 16 A	0 577 12 + 0 577 13	-	-
0 577 06	3	3 x 16 A or 3 x 32 A or 3 x 63 A	0 577 12 x 3	0 577 12 x 3	0 577 17 x 3
		1 x 16 or 32 A + 2 x 63 A	0 577 12	-	0 577 17 x 2
		2 x 16 or 32 A + 1 x 63 A	0 577 12 x 2		0 577 17
	4	2 x 16 A + 1 x 32 A + 1 x 63 A	0 577 13	0 577 12	0 577 17
		2 x 16 A + 2 x 32 A	0 577 13	0 577 12 x 2	-
		2 x 16 A + 2 x 63 A	0 577 13	-	0 577 17 x 2
5	4 x 16 A + 1 x 32 A	0 577 13 x 2	0 577 12	-	
	4 x 16 A + 1 x 63 A	0 577 13 x 2	-	0 577 17	
	16 A	0 577 13 x 3	-	-	

### EXAMPLE OF SOCKETS

ELV (p. 331)			IP 44		
20/25 V~	16 A	2P	0 552 45		
	32 A	2P	0 552 95		
Domestic pin (p. 331)			IP 54 <sup>(3)</sup>		
250 V	16 A	2P+E	0 576 72/76		
LV (p. 328 to 333)			IP 44		
200/250 V~	16 A	2P+E	5 551 84	5 553 84	
	32 A	2P+E	5 552 84	5 554 84	
	63 A	2P+E	-	0 587 20	
380/415 V~	16 A	3P+E	5 551 88	5 553 88	
		3P+N+E	5 551 89	5 553 89	
	32 A	3P+E	5 552 88	5 554 88	
		3P+N+E	5 552 89	5 554 89	
		63 A	3P+E	-	
3P+N+E	-		0 587 25		

### Examples of most common combinations with bases for 280 x 125 mm faceplates

Base	Total number of sockets on the base	Socket combination	Face plate according to the socket intensity		
			16 A	32 A	63 A
0 577 11 or 0 577 20	2	2 x 16 A or 2 x 32 A	0 577 18		-
	3	2 x 16 A interlocked sw.	0 577 23	-	-
0 577 03	4	3 x 16 A	0 577 14	-	-
		4 x 16 A or 4 x 32 A	0 577 18 x 2		
		2 x 16 or 32 A + 2 x 63 A	0 577 19 x 2		
	5	3 x 16 or 32 A + 1 x 63 A	0 577 18 + 0 577 19		
		4 x 16 A interlocked sw.	0 577 23 x 2	-	-
0 577 04	6	3 x 16 A + 1 x 16 or 32 A + 1 x 63 A	0 577 14 + 0 577 19		
		3 x 16 A + 2 x 16 or 32 A	0 577 14 + 0 577 18	-	-
		6 x 16 A or 32 A	0 577 18 x 3		
	7	3 x 16 or 32 A + 3 x 63 A	0 577 19 x 3		
		5 x 16 or 32 A + 1 x 63 A	0 577 18 x 2 + 0 577 19		
		4 x 16 or 32 A + 2 x 63 A	0 577 18 + 0 577 19 x 2		
	8	6 x 16 A interlocked sw.	0 577 23 x 3	-	-
		3 x 16 A + 2 x 16 or 32 A + 2 x 63 A	0 577 14 + 0 577 19 x 2		
		3 x 16 A + 4 x 16 or 32 A	0 577 14 + 0 577 18 x 2		
9	3 x 16 A + 3 x 16 or 32 A + 1 x 63 A	0 577 14 + 0 577 18 + 0 577 19			
	6 x 16 A + 1 x 16 or 32 A + 1 x 63 A	0 577 14 x 2 + 0 577 19			
9	6 x 16 A + 2 x 16 or 32 A	0 577 14 x 2 + 0 577 18			

**Dimensions**

Cable glands are not supplied  
Entries to drill

**Bases**

Cat.No 0 589 38

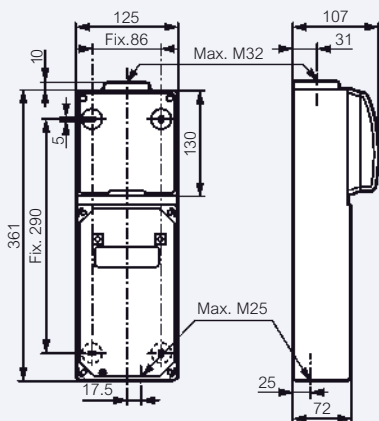

Cat.No 0 577 20

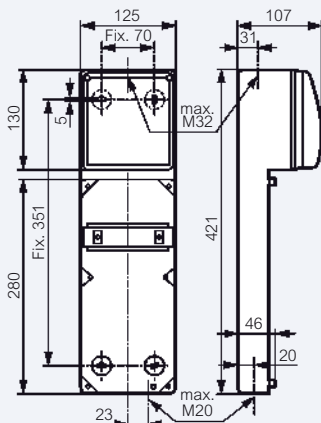

Cat.No 0 577 05

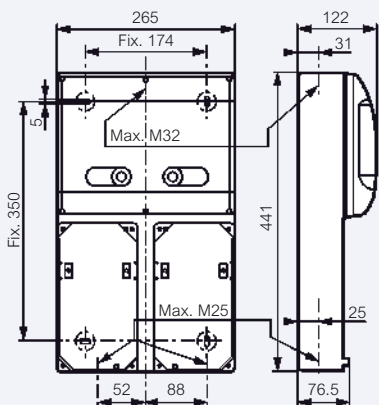

Cat.No 0 577 06

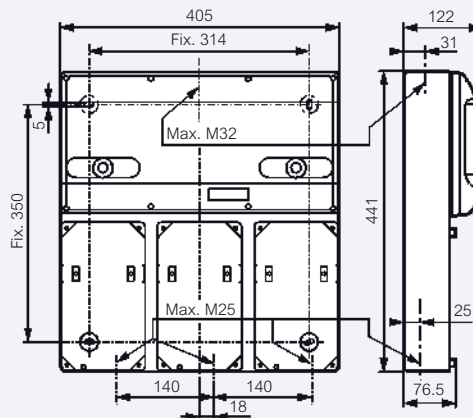

Cat.No 0 577 03

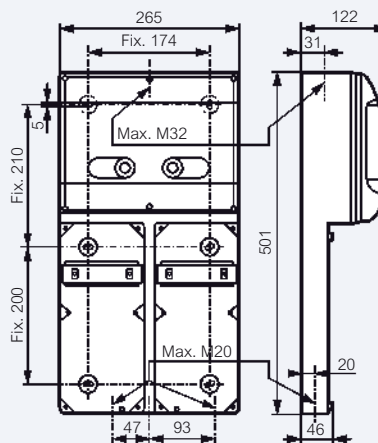

Cat.No 0 577 04

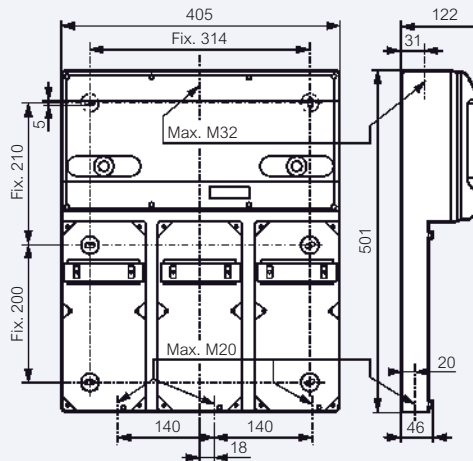

**Surface mounting boxes**

Cat.No 0 577 10

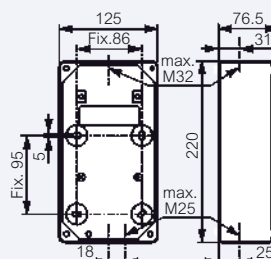

Cat.No 0 577 11

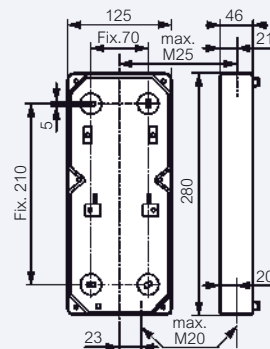

## P 17 Tempra combined units LV 16 to 63 A

interlocked switched sockets

16-32 A			without rail				with empty Din rail					
<ul style="list-style-type: none"> <li>• IP 44, IP 55, IP 66 according to IEC 60529 and EN 60529</li> <li>• IK 08 according to IEC 62262</li> <li>• Conform to IEC 60439-1</li> <li>• Supplied without cable glands</li> <li>• Self-extinguishing: 650 °C</li> </ul>			125 x 220 mm				125 x 280 mm					
			IP 44		IP 55		IP 44		IP 66			
Pack	Cat.Nos	Pack	Cat.Nos	Pack	Cat.Nos	Pack	Cat.Nos	Pack	Cat.Nos			
200 to 250 V ~ 50/60 Hz	16 A	2P+E	1	0 566 01	1	0 566 21	1	0 566 41	1	0 566 61		
	32 A	2P+E	1	0 566 09	1	0 566 29	1	0 566 49	1	0 566 69		
380 to 415 V ~ 50/60 Hz	16 A	3P+E	1	0 566 05	1	0 566 25	1	0 566 45	1	0 566 65		
		3P+N+E	1	0 566 06	1	0 566 26	1	0 566 46	1	0 566 66		
	32 A	3P+E	1	0 566 13	1	0 566 33	1	0 566 53	1	0 566 73		
		3P+N+E	1	0 566 14	1	0 566 34	1	0 566 54	1	0 566 74		
63 A			without rail				with empty Din rail					
<ul style="list-style-type: none"> <li>• IP 66 according to IEC 60529 and EN 60529</li> <li>• IK 08 according to IEC 62262</li> <li>• Conform to IEC 60439-1</li> <li>• Supplied without cable glands</li> <li>• Self-extinguishing: 650 °C</li> </ul>			IP 66				IP 66					
			Pack	Cat.Nos	Pack	Cat.Nos	Pack	Cat.Nos	Pack	Cat.Nos		
380 to 415 V ~ 50/60 Hz	63 A	3P+E	1	0 572 98	1	0 589 18						
		3P+N+E	1	0 589 10	1	0 572 99						

## P 17 Tempra combined units LV 16 to 63 A

interlocked switched sockets

### Dimensions

Without rail  
LV 16/32 A

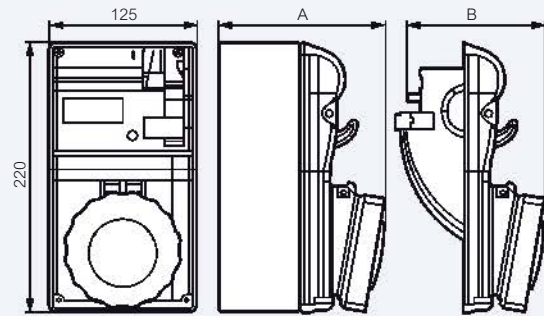

	IP 44 Cat.Nos	Dimensions (mm)		IP 55 Cat.Nos	Dimensions (mm)		
		A	B		A	B	
LV 16 A	2P+E	0 566 01	127	122	0 566 21	133	128
	3P+E	0 566 05	129	124	0 566 25	134	129
	3P+N+E	0 566 06	130	125	0 566 26	135	130
LV 32 A	2P+E	0 566 09	138	133	0 566 29	143	138
	3P+E	0 566 13	138	133	0 566 33	143	138
	3P+N+E	0 566 14	139	134	0 566 34	144	139

With empty Din rail  
LV 16/32 A

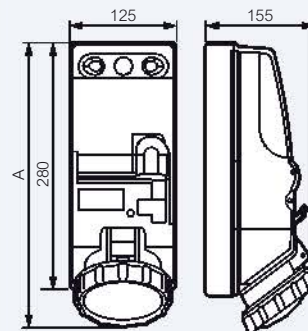

	A	
	IP 44	IP 66
LV 16 A	290	300
LV 32 A	295	310

LV 63 A

Cat.Nos 0 572 98 and 0 589 10

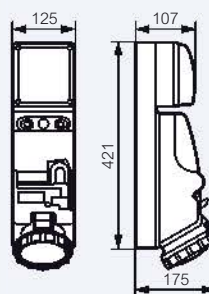

LV 63 A

Cat.Nos 0 589 18 and 0 572 99

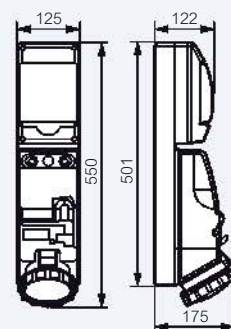

110 VA combined units  
**Please consult us**







MCBs  
p. 40

Interlocked switched sockets with small flange p. 326



# Hypra<sup>®</sup> IP 44 sockets and plugs metal, plastic, rubber, IP 44/55 Prisinter

LV 16 to 63 A and ELV 16 and 32 A

Conform to IEC 60309-1 and IEC 60309-2 IP 44 according to IEC 60529 IK 09: plastic and rubber IK 10: metal according to IEC 62262 Self-extinguishing: - 850°C (support of active parts) / 960 °C for Prisinter) - 650 °C: plastic housing conform to IEC 60695-2-10 - 50°C to + 100°C (- 20°C for Prisinter)   Dimensions p. 343			Prisinter <sup>(2)</sup>				Panel mounting sockets			Surface mounting sockets		Through wiring surface mounting sockets
												
			Female connector		Female connector		Female connector			Female connector		Female connector
			Panel mounting sockets		Surface mounting sockets		metal	plastic	with single fixing centres	metal	plastic	Female connector
LV			metal	plastic	metal	plastic	metal	plastic	with single fixing centres	metal	plastic	plastic
200 to 250 V <sub>~</sub> 50/60 Hz	16 A	2P+E	0 520 12	0 520 02	0 520 12 + 0 520 59	0 520 02 + 0 520 49	0 520 32	0 520 22 <sup>(1)</sup>	0 520 18 <sup>(1)</sup>	0 520 32 + 0 520 39	0 520 22 <sup>(1)</sup> + 0 520 29 <sup>(1)</sup>	520 22 <sup>(1)</sup> + 0 520 89
	32 A	2P+E	-	0 527 02	-	0 527 02 + 0 529 49	0 527 32	-	0 527 18	0 527 32 + 0 529 39	0 527 18 + 0 529 40	0 527 18 + 0 529 90
380 to 415 V <sub>~</sub> 50/60 Hz	16 A	3P+E	0 522 13	0 522 03	0 522 13 + 0 520 59	0 522 03 + 0 520 49	0 522 33	0 522 23 <sup>(1)</sup>	0 522 19 <sup>(1)</sup>	0 522 33 + 0 522 39 <sup>(1)</sup>	0 522 23 <sup>(1)</sup> + 0 522 29 <sup>(1)</sup>	0 522 23 <sup>(1)</sup> + 0 522 89
		3P+N+E	0 522 14	0 522 04	0 522 14 + 0 529 59	0 522 04 + 0 522 49	0 522 34	0 522 24 <sup>(1)</sup>	0 522 20	0 522 34 + 0 522 39 <sup>(1)</sup>	0 522 24 <sup>(1)</sup> + 0 522 29 <sup>(1)</sup>	0 522 24 <sup>(1)</sup> + 0 522 89
	32 A	3P+E	0 529 13	0 529 03	0 529 13 + 0 522 59	0 529 03 + 0 529 49	0 529 33	-	0 529 19	0 529 33 + 0 529 39	0 529 19 + 0 529 40	0 529 19 + 0 529 90
		3P+N+E	0 529 14	0 529 04	0 529 14 + 0 522 59	0 529 04 + 0 529 49	0 529 34	-	0 529 20	0 529 34 + 0 529 39	0 529 20 + 0 529 40	0 529 20 + 0 529 90
	63 A	3P+E	0 538 00	0 536 03	0 538 00 + 0 538 09	0 536 03 + 0 537 49	0 538 33	0 538 23	-	0 537 33	0 537 23	0 538 23 + 0 538 89
		3P+N+E	0 538 01	0 536 04	0 538 01 + 0 538 09	0 536 04 + 0 537 49	0 538 34	0 538 24	-	0 537 34	0 537 24	0 538 24 + 0 538 89
ELV												
20 to 25 V <sub>~</sub> 50/60 Hz	16 A	2P	-	-	-	-	-	0 524 01 <sup>(1)</sup>	-	-	0 524 01 <sup>(1)</sup> + 0 524 19 <sup>(1)</sup>	-
	32 A	2P	-	-	-	-	-	0 525 01	-	-	0 525 01 + 0 524 19 <sup>(1)</sup>	-

Pack = 1 except 1: pack = 5

2: Dust resistance IP may be increased by rubber push-button (on request) - IP 55 cover closed or connected - IP 44 connected

Straight plugs			Angled plugs			Mobile sockets		Panel appliance inlets		Surface appliance inlets	
Male connector			Male connector			Female connector		Male connector		Male connector	
metal	plastic	rubber	metal	plastic	rubber	plastic	rubber	metal	plastic	metal	plastic
0 521 42	0 520 42 <sup>(1)</sup>	0 520 52 <sup>(1)</sup>	0 520 72	0 520 62 <sup>(1)</sup>	0 521 52	0 520 82 <sup>(1)</sup>	0 520 92	0 521 62	0 521 72	0 521 62 + 0 520 69	0 521 72 + 0 520 79
-	0 527 42	0 527 52	0 527 72	0 527 62		0 527 82	0 527 92	0 528 62	0 528 72	0 528 62 + 0 529 69	0 528 72 + 0 529 79
0 521 43	0 522 43 <sup>(1)</sup>	0 522 53 <sup>(1)</sup>	0 522 73	0 522 63 <sup>(1)</sup>	0 521 53 <sup>(1)</sup>	0 522 83 <sup>(1)</sup>	0 522 93 <sup>(1)</sup>	0 521 63	0 521 73	0 521 63 + 0 522 69	0 521 73 + 0 522 79
0 521 44	0 522 44 <sup>(1)</sup>	0 522 54	0 522 74	0 522 64	0 521 54	0 522 84	0 522 94	0 521 64	0 521 74	0 521 64 + 0 522 69	0 521 74 + 0 522 79
0 528 43	0 529 43 <sup>(1)</sup>	0 529 53 <sup>(1)</sup>	0 529 73	0 529 63	0 528 53	0 529 83	0 529 93 <sup>(1)</sup>	0 528 63	0 528 73	0 528 63 + 0 529 69	0 528 73 + 0 529 79
0 528 44	0 529 44 <sup>(1)</sup>	0 529 54	0 529 74	0 529 64	0 528 54	0 529 84	0 529 94	0 528 64	0 528 74	0 528 64 + 0 529 69	0 528 74 + 0 529 79
-	0 538 43	0 538 53	0 538 73	-	0 538 63	0 538 83	0 538 93	-	0 537 73	-	0 537 73 + 0 538 79
-	0 538 44	0 538 54	0 538 74	-	0 538 64	0 538 84	0 538 94	-	0 537 74	-	0 537 74 + 0 538 79
-	0 524 21 <sup>(1)</sup>	-	-	-	0 524 41 <sup>(1)</sup>	0 524 81	0 524 61	-	-	-	-
-	0 525 21	-	-	-	0 525 41	0 525 81	0 525 61	-	-	-	-

Mobile products dimensions  
see e-catalogue

100 to 130 V $\sim$  and 480 to 500 V $\sim$   
available on request  
**Please, consult us**



Conform to IEC 60309-1 and IEC 60309-2 IP according to IEC 60529 IK 09: Plastic Self-extinguishing: 850°C (support of active parts) / 650°C (plastic housing)  Dimensions p. 344			FUNCTIONS									
			Panel mounting sockets		Surface mounting sockets	Through wiring surface mounting sockets	Straight plugs	Angled plugs	Mobile sockets	Surface appliance inlets	Straight panel appliance inlets	Socket with break isolating switch
			inclined outlets	with single fixing centres								
200 to 250 V~ 50/60 Hz	16 A	2P+E	0 511 26 <sup>(1)</sup>	0 511 46	0 511 26 + 0 520 29 <sup>(1)</sup>	0 511 26 + 0 520 89	0 511 56 <sup>(1)</sup>	0 511 06	0 511 76	0 511 86	-	-
	32 A	2P+E	-	0 530 46	0 530 46 + 0 529 40	0 530 46 + 0 529 90	0 530 56	0 530 06	0 530 76	0 530 86	-	-
380 to 415 V~ 50/60 Hz	16 A	3P+E	0 511 30	0 511 50	0 511 30 + 0 522 29 <sup>(1)</sup>	0 511 30 + 0 522 89	0 511 60 <sup>(1)</sup>	0 511 10	0 511 80	0 511 90	-	-
		3P+N+E	0 511 31	0 511 51	0 511 31 + 0 522 29 <sup>(1)</sup>	0 511 31 + 0 522 89	0 511 61 <sup>(1)</sup>	0 511 11	0 511 81	0 511 91	-	-
	32 A	3P+E	-	0 530 50	0 530 50 + 0 529 40	0 530 50 + 0 529 90	0 530 60	0 530 10	0 530 80	0 530 90	-	-
		3P+N+E	-	0 530 51	0 530 51 + 0 529 40	0 530 51 + 0 529 90	0 530 61	0 530 11	0 530 81	0 530 91	-	-
	63 A	3P+E	0 594 27	-	0 594 37	0 594 27 + 0 538 89	0 594 47	-	0 594 87	-	0 594 77 <sup>(2)</sup>	-
		3P+N+E	0 594 28	-	0 594 38	0 594 28 + 0 538 89	0 594 48	-	0 594 88	-	0 594 78 <sup>(2)</sup>	-
125 A	3P+E	0 595 12	-	0 595 02	-	0 595 22	-	0 595 32	-	0 595 42	0 591 14	
	3P+N+E	0 595 13	-	0 595 03	-	0 595 23	-	0 595 33	-	0 595 43	0 591 15	

Pack = 1 except 1: pack = 5  
 2: Can be fixed on Cat.No 0 538 89 to obtain a straight surface mounting appliance inlet

### Complete range from 16 A to 125 A: IP 55 (minimum) guaranteed

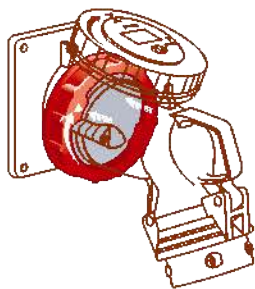

When connected: IP 55 guaranteed with the cover closed on the plug (with a pair of Hypra IP 66/67-55 products)

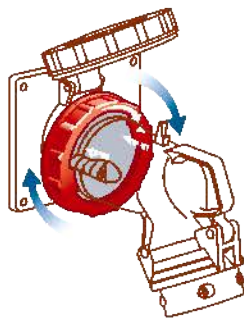

IP 66/67 obtained with the ring locked

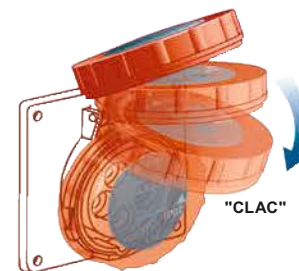

When not connected IP 55 assured when cover is closed; IP 66/67 obtained with the ring locked



# Hypro<sup>®</sup> IP 44 and IP 44/55 Prisinter™

LV 16 to 125 A

## Prisinter - panel mounting sockets - LV 16-32-63 A (p. 340)

Terminal connection (max.)

BT 16 A : rigid - 1 x 4 mm<sup>2</sup>

BT 32 A : rigid - 1 x 10 mm<sup>2</sup>

BT 63 A : rigid - 1 x 25 mm<sup>2</sup>

Prisinter sockets 32 A : flexible - 1 x 6 mm<sup>2</sup>

Prisinter sockets 63 A : flexible - 1 x 16 mm<sup>2</sup>

Conform to EN 60309-1, NF EN 60309-2, IEC 60309-1 and IEC 60309-2

IK 09 : plastic and rubber

IK 10 : metal according to EN 62262 et IEC 62262

Self-extinguishing :

850 °C support of active parts, 950 °C for Prisinter

650 °C plastic housing

- 50 °C à + 100 °C (- 20 °C for Prisinter)

Icc 10 kA according to EN 60309-1 and IEC 60309-1

Dust resistance IP may be increased by rubber push-button (on request)

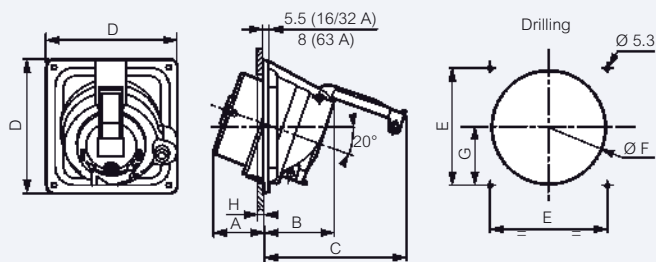

	Material	Weight (kg)	A	B	C	D	E	F min	F max	G	H max
<b>16 A</b>											
2P+E	Plastic	0.420	46	70	132	115	100	92	98	46	6 to 10
	Metal	1.250									
3P+E	Plastic	0.480	46	70	138	115	100	92	96	46	6 to 10
	Metal	1.330									
3P+N+E	Plastic	0.570	46	75	156	125	110	102	106	51.5	7
	Metal	1.470									
<b>32 A</b>											
2P+E	Plastic	0.570	54	77	153	143	125	115	122	58.5	10 to 20
	Metal	1.470									
3P+E	Plastic	0.610	54	77	153	143	125	115	122	58.5	10 to 20
	Metal	1.500									
3P+N+E	Plastic	0.650	55	79	169	143	125	119	122	58.5	9 to 13
	Metal	1.800									
<b>63 A</b>											
2P+E	Plastic	0.870	55	99	205	143	125	120	122	59.5	10 to 20
	Metal	1.500									
3P+E	Plastic	0.950	55	99	205	143	125	120	122	59.5	10 to 20
	Metal	1.850									
3P+N+E	Plastic	0.980	55	99	205	143	125	120	122	59.5	10 to 20
	Metal	2.200									

## Breaking capacity 3 x 400 V<sub>~</sub> according to IEC 60947-1-3

Category	16 A	32 A	63 A	Category	125 A	
AC 1	16 A	32 A	63 A	AC 22 AC 23	400 V	70 kW
AC 23	8.4 kW	16.8 kW	33 kW		500 V	87 kW
AC 3					600 V	120 kW

## Reversible box for Prisinter sockets

### LV 16 A (p. 340)

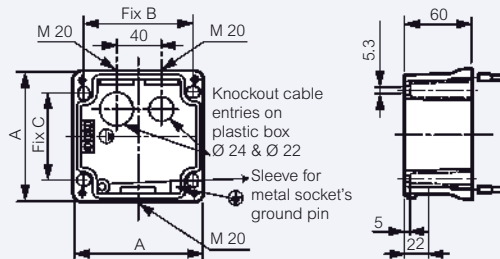

3 entries among which

2 entries M20 sealed with B20P blanking plug for auxiliary contact use  
Fitted with 2 connected earth terminals and 1 outside terminal on metal box

	Material	Weight (kg)	A (mm)	B (mm)	C (mm)
2P+E	Plastic	0.140	115	97	78
	Metal	0.800			
3P+N+E	Plastic	0.160	125	107	88
	Metal	0.900			

### LV 32 A (p. 340)

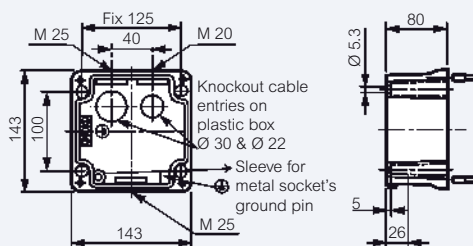

3 entries among which

1 M20 sealed with B20P blanking plug for auxiliary contact  
1 M25 sealed with B25P blanking plug

Fitted with 2 connected earth terminals and 1 outside terminal on metal box

### LV 63 A (p. 340)

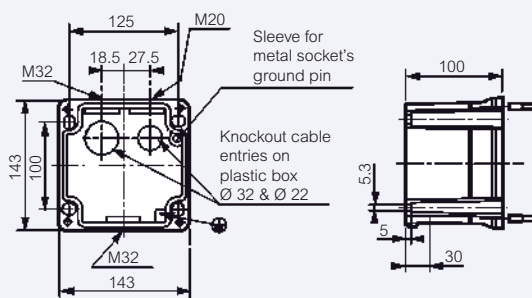

3 entries among which

1 M20 sealed with B20P blanking plug for auxiliary contact  
1 M32 sealed with B32P blanking plug

Fitted with 1 outside earth terminal on metal box

Dust resistance IP can be increased by a rubber push-button,  
**On special request**



# Hypro® IP 44, IP 66/67-55 panel mounting sockets

LV 16 to 125 A and ELV 16 and 32 A

## Dimensions

### IP 44 - LV 16 to 63 A (p. 340) and ELV 16 and 32 A

External screws in stainless steel - Nickel-plated contacts  
Enable realization of surface mounting sockets, associated with reversible box

Terminal connection (max.):

- LV 16 A: 1 x 4 mm<sup>2</sup> rigid
- LV 32 A: 1 x 10 mm<sup>2</sup> rigid
- LV 63 A: 1 x 25 mm<sup>2</sup> rigid
- ELV: 1 x 10 mm<sup>2</sup> rigid

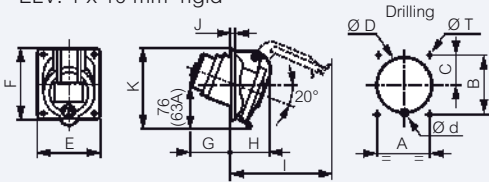

	Material	Weight (kg)	Drilling					Dimensions																	
			A	B	C	ØD	Ød	ØT	E	F	G	H	I	J	K										
<b>LV - 16 A</b>																									
2P+E	Plastic	0.110																							
	Metal	0.340	52	60	28	55	14.5	4.2	64	72	41	40	94	5.5	78.5										
3P+E	Plastic	0.140																							
	Metal	0.405	60	70	31	63.5	14.5	5.2	74	84	44	40	98	5.5	88										
3P+N+E	Plastic	0.165																							
	Metal	0.450	60	70	33	70.6	-	5.2	80	84	44	44	110	5.5	93										
<b>LV - 32 A</b>																									
2P+E/ 3P+E	Metal	0.605	70	80	38	76.2	10	5.2	84	94	50	53	120	5.5	103										
3P+N+E	Metal	0.660	70	80	38	76.2	10	5.2	84	94	52	56	124	5.5	107										
<b>LV - 63 A</b>																									
2P+E	Plastic	0.600																							
	Metal	0.950																							
3P+E	Plastic	0.640	77	85	-	92	-	6.5	106	106	98	70	160	6	129										
	Metal	1.000																							
3P+N+E	Plastic	0.700																							
	Metal	1.200																							
<b>ELV-16/32 A</b>																									
2P	Plastic	0.120	52	60	30	55	-	4.2	64	72	33	47	94	5.5	78.5										

### IP 44 - LV 16 and 32 A with single fixing centres (p. 340)

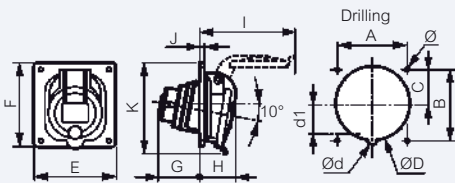

	Weight (kg)	A	B	C	ØD	Ød	d1	E	F	G	H	I	J	K	Ø
<b>LV 16 A</b>															
2P+E	0.110	70	70	35	76.2	/	/	84	84	37	36	89	4.5	88	4.2
3P+E	0.140	70	70	35	76.2	/	/	84	84	43	36	97	4.5	89	4.2
3P+N+E	0.165	70	70	35	76.2	/	/	84	84	43	37	106	4.5	91	4.2
<b>LV - 32 A</b>															
2P+E/ 3P+E	0.220	70	70	35	76.2	-	-	84	94	54	45	117	4.5	100	4.2
3P+N+E	0.255	70	70	35	76.2	8	36	84	94	54	46	125	4.5	102	4.2

### IP 66/67-55 - LV 16 A (p. 342)

External screws in stainless steel - Nickel-plated contacts  
Terminal connection (max.): 1 x 4 mm<sup>2</sup> rigid or flexible

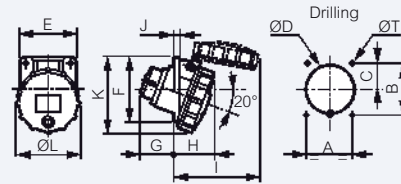

	Weight (kg)	Drilling					Dimensions									
		A	B	C	ØD	ØT	E	F	G	H	I	J	K	L		
<b>LV - 16 A</b>																
2P+E	0.140	52	60	33	55	4.2	64	72	40	45	91	5.5	87	72.5		
3P+E	0.165	60	70	39	63.5	5.2	74	84	41	48	102	5.5	96	81		
3P+N+E	0.195	60	70	37	70.6	5.2	80	84	42	50	106	5.5	96	86.5		

### IP 66/67-55 - LV 63 A (p. 342)

Terminal connection (max.): 1 x 25 mm<sup>2</sup> rigid

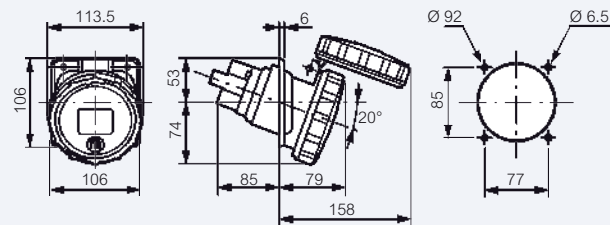

	Weight (kg)
2P+E	0.680
3P+E	0.710
3P+N+E	0.770

### IP 66/67-55 - LV 125 A (p. 342)

Terminal connection (max.): 1 x 70 mm<sup>2</sup> rigid

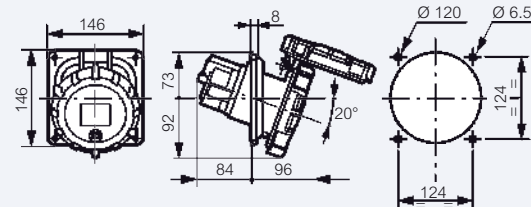

	Weight (kg)
3P+E	1.400
3P+N+E	1.550

### IP 66/67-55 - LV 16 and 32 A with single fixing centres (p. 342)

Terminal connection (max.):

- 16 A: 1 x 4 mm<sup>2</sup> rigid
- 32 A: 1 x 10 mm<sup>2</sup> rigid

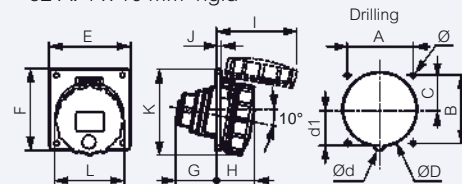

	Weight (kg)	Drilling							Dimensions (mm)									
		A	B	C	ØD	Ød	d1	Ø	E	F	G	H	I	J	K	ØL		
<b>LV 16 A</b>																		
2P+E	0.140	70	70	35	76.2	-	-	4.2	84	84	42	39	83	4.5	90	72.5		
3P+E	0.165	70	70	35	76.2	-	-	4.2	84	84	43	41	98	4.5	93	81		
3P+N+E	0.195	70	70	35	76.2	-	-	4.2	84	84	43	41	99	4.5	91	86.5		
<b>LV 32 A</b>																		
2P+E	0.240	70	70	35	76.2	-	-	4.2	84	94	54	50	113	4.5	101	94.5		
3P+E	0.240	70	70	35	76.2	-	-	4.2	84	94	54	50	113	4.5	101	94.5		
3P+N+E	0.270	70	70	35	76.2	8	36	4.2	84	94	54	51	120	4.5	103	101		

## Hypra<sup>®</sup> IP 44, IP 66/67-55 surface mounting sockets reversible box

## Hypra<sup>®</sup> IP 44, IP66/67-55 and IP 66/67 through wiring surface mounting sockets

### ■ Dimensions

IP 44 ELV 16 and 32 A - IP 44, IP 66/67-55 - LV 16 A (p. 340, 342)

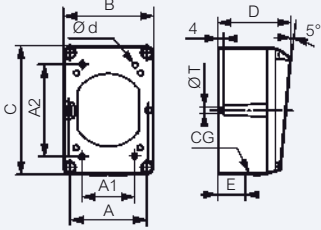

Fix A1 and A2:  
Blind optional fixing points  
Metal boxes fitted with  
- 2 connected earth terminals and  
1 outside terminal  
- 1 sleeve for metal socket's ground pin

Surface mounting sockets → Panel mounting sockets ↓	Material	Weight (kg)	Drilling					Dimensions					CG cable gland
			A1	A2	Ød	A	ØT	B	C	D	E		
<b>IP 44 - ELV 16/32 A</b>													
2P+E	Plastic	0.115	51	68	4.2	64	5.3	74	106	58	20	M 25	
<b>IP 44 and IP 66/67-55 - LV 16 A</b>													
2P+E	Plastic	0.115	51	68	4.2	64	5.3	74	106	58	20	M 20	
	Metal	0.400											
3P+E/ 3P+N+E	Plastic	0.160	68	68	4.2	85	5.3	96	122	60	22	M 20	
	Metal	0.520											

IP 44, IP 66/67-55 - LV 32 A (p. 340, 342)

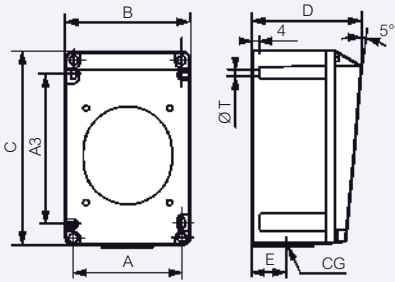

Blind optional fixing points  
Metal boxes fitted with  
- 2 connected earth terminals and  
1 outside terminal  
- 1 sleeve for metal socket's ground pin

Surface mounting sockets → Panel mounting sockets ↓	Material	Weight (kg)	Drilling				Dimensions				CG cable gland
			A	A3	ØT	B	C	D	E		
<b>IP 44 and IP 66/67-55 - LV 32 A</b>											
2P+E/ 3P+E/ 3P+N+E	Plastic	0.340	90	125	5.3	102	162	90	26	M 25	
	Metal	0.910									

### ■ Dimensions

IP 44 - LV 16 to 63 A, IP 66/67-55 - LV 16 and 32 A, IP 66/67 - LV 63 A (p. 340, 342)

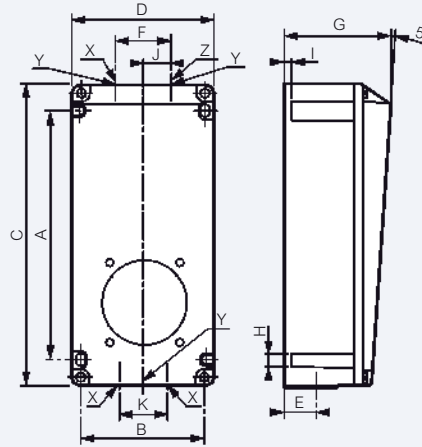

Surface mounting sockets → Panel mounting sockets ↓	Material	Weight (kg)	Drilling					Dimensions									
			A	B	H	C	D	E	F	G	I	J	K	X	Y	Z	
<b>16 A</b>																	
2P+E	Plastic	0.330	145	74	5.3	182	86	22	34	75	4	-	-	-	M 20		
	Metal	0.830															
3P+E/ 3P+N+E	Plastic	0.440	175	88	5.3	212	100	22	40	77	4	-	-	-	M 20		
	Metal	0.980															
<b>32 A</b>																	
2P+E/ 3P+E/ 3P+N+E	Plastic	0.670	234	117	5.3	270	130	30	50	120	4	-	-	-	M 25		
	Metal	1.730															
<b>63 A (Panel appliance inlets 63 A can be fixed)</b>																	
2P+E/ 3P+E/ 3P+N+E	Plastic	2.000	260	152	6.3	300	170	40	-	150	8	50	70	M 32	-		
	Metal	4.300															

## Hypra<sup>®</sup> IP 44 and IP 66/67-55 surface mounting sockets

External screws in stainless steel - Nickel-plated contacts

### IP 44 - LV 63 A (p. 340)

Terminal connection: 1 x 25 mm<sup>2</sup> rigid max.

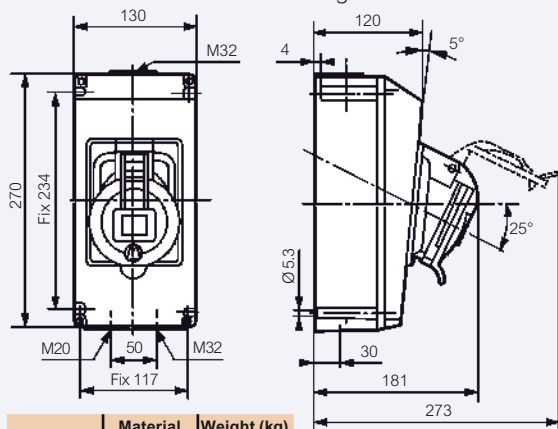

	Material	Weight (kg)
3P+E	Plastic	1.45
	Metal	4.95
3P+N+E	Plastic	1.5
	Metal	5

### IP 66/67-55 - LV 63 A (p. 342)

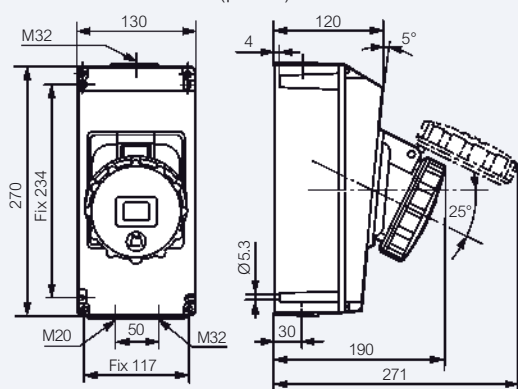

	Weight (kg)
2P+E	1.500
3P+E	1.550
3P+N+E	1.600

### IP 66/67-55 - LV 125 A (p. 342)

Terminal connection: 1 x 70 mm<sup>2</sup> rigid max.

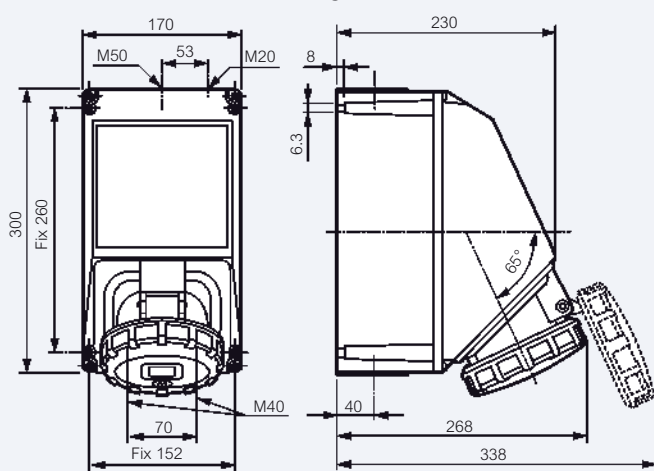

	Weight (kg)
3P+E	3.5
3P+N+E	3.7

## Hypra<sup>®</sup> IP 44 - panel appliance inlets and reversible boxes

External screws in stainless steel - Nickel-plated contacts

### Panel appliance inlets (inclined)

#### IP 44: LV 16, 32 and 63 A (p. 340)

Terminal connections:

- 16 A: 1 x 2.5 mm<sup>2</sup> max. rigid
- 32 A: 1 x 6 mm<sup>2</sup> max. rigid
- 63 A: 1 x 25 mm<sup>2</sup> max. rigid

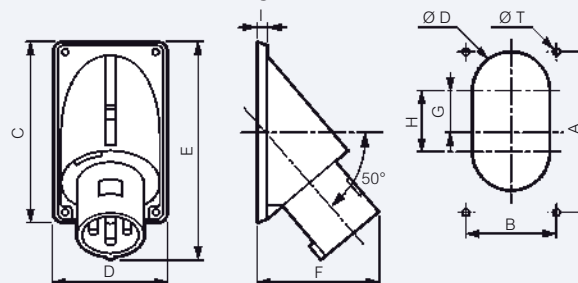

	Material	Weight (kg)	Drilling					Dimensions					
			A	B	ØT	ØD	G	H	C	D	E	F	I
<b>LV - 16 A</b>													
2P+E	Plastic	0.140	94	62	4.5	40	-	-	104	72	121	78	6
	Metal	0.530											
3P+E	Plastic	0.160	109	83	4.5	40	-	-	120	94	135	86	6
	Metal	0.630											
3P+N+E	Plastic	0.190	109	83	4.5	40	-	-	120	94	139	86	6
	Metal	0.690											
<b>LV - 32 A</b>													
2P+E/3P+E	Plastic	0.280	149	90	5.5	40	-	-	160	101	176	111	6
	Metal	0.950											
3P+N+E	Plastic	0.320	149	90	5.5	40	-	-	160	101	174	108	6
	Metal	1.000											
<b>LV - 63 A</b>													
2P+E	Plastic	0.560	163	93	6.5	80	42	62	183	113	221	120	8
3P+E	Plastic	0.630											
3P+N+E	Plastic	0.690	163	93	6.5	80	42	62	183	113	221	120	8
	Metal	2.230											
3P+N+E	Plastic	0.690	163	93	6.5	80	42	62	183	113	221	120	8
	Metal	2.450											

### Reversible boxes for surface appliance inlets

#### LV 16 A (p. 340)

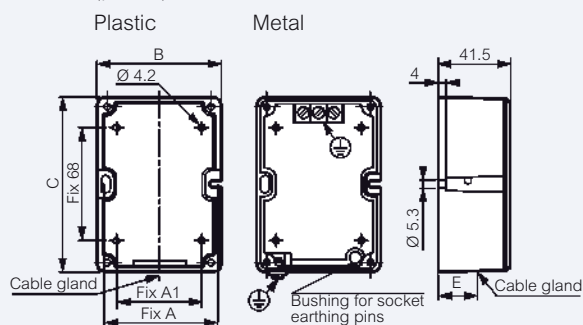

Fix A1 and Fix 68 :  
Blind optional fixing points

	Material	Weight (kg)	A	A1	B	C	E	Cable gland
2P+E	Plastic	0.085	64	51	74	106	20	M20
	Metal	0.250						
3P+E	Plastic	0.110	85	68	96	122	22	M20
	Metal	0.360						

## Hypra<sup>®</sup> IP 44 and IP 66/67-55 - appliance inlets and reversible boxes

### LV 32 A (p. 340)

Fitted with 2 connected earth terminals and 1 outside terminal on metal box

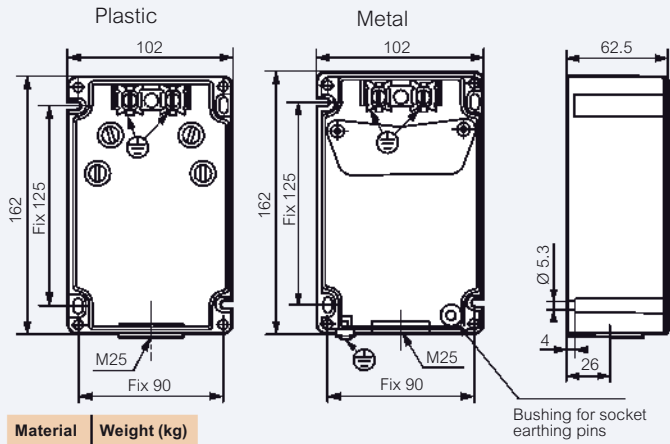

Material	Weight (kg)
Plastic	0.240
Metal	0.650

### LV 63 A (p. 340)

Fitted with 2 connected earth terminals and 1 outside terminal on metal box

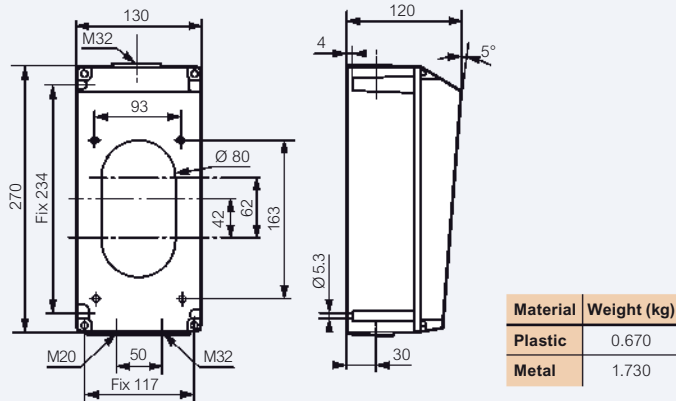

Material	Weight (kg)
Plastic	0.670
Metal	1.730

### Surface mounting appliance inlets

#### IP 66/67-55 - LV 16 and 32 A (p. 342)

Terminal connections:  
 • 16 A: 1 x 2.5 mm<sup>2</sup> max. rigid  
 • 32 A: 1 x 6 mm<sup>2</sup> max. rigid

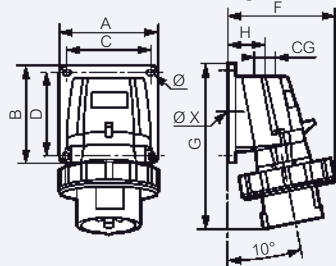

	Weight	A/B	C/D	F	G	H	CG cable gland	Ø	ØX
<b>16 A</b>									
2P + E	0.188			87	126				
3P + E	0.257	84	72	95	134	34	M 20	4.3	17
3P+N+E	0.297			100	141				
<b>32 A</b>									
2P + E	0.370			107	168	39	M 25	5.3	24
3P + E		110	98						
3P+N+E	0.413			113					

## Hypra<sup>®</sup> IP 66/67-55 - appliance inlets and sockets with break isolating switch

### Panel mounting appliance inlets

External screws in stainless steel - Nickel-plated contacts

#### IP 66/67-55 - 63 A (p. 342)

Can be fixed on box Cat.No 0 538 89 (p. 340)  
 Terminal connection: 1 x 16 mm<sup>2</sup> max. rigid

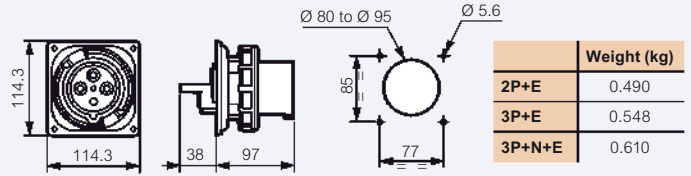

	Weight (kg)
2P+E	0.490
3P+E	0.548
3P+N+E	0.610

#### IP 66/67-55 - 125 A (p. 342)

Terminal connection: 1 x 50 mm<sup>2</sup> max. rigid

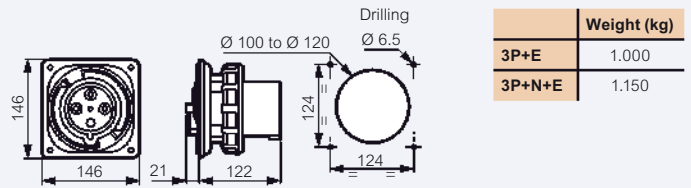

	Weight (kg)
3P+E	1.000
3P+N+E	1.150

### Socket with break isolating switch

#### IP 66/67-55 - LV 125 A (p. 342)

IP 67 according to IEC and EN 60529  
 Icc 10 kA according to IEC and EN 60309-1  
 Panel mounting sockets: IK 09 according to IEC and EN 62262  
 External screws in stainless steel

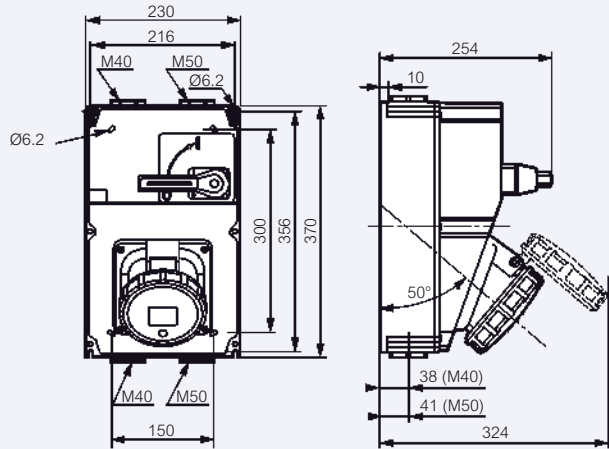



0 414 62



0 413 49



0 414 19



0 415 23



0 415 33 with claws

Pack	Cat.Nos	Class I			
		Double insulated Polyester corrosion resistant finish 200 hours maxi. continuous rating			
		<b>IP 44 - IK 10 - Direct current version</b> Ø150 mm gong			
1	RAL 3000 Red 0 414 62	Voltage = 24 V	Average Consumption (mA) 70	Average acoustic output at 1 m (dB) 90	Weight (kg) 1
		<b>IP 40 - IK 08 - 50/60 Hz - Alternating current version</b> Ø100 mm gong			
1	RAL 7037 Grey 0 413 49	Voltage ~ 230 V	Consumption (mA) 50	Average acoustic output at 1 m (dB) 95	Weight (kg) 0.8
		<b>IP 44 - IK 10</b> Ø150 mm gong			
1	0 414 16	24V	360	98	1
1	0 414 18	110/130 V	90	98	1
1	0 414 19	230 V	50	98	1
		<b>IP 44 - IK 10</b> Ø250 mm gong			
1	0 414 39	230 V	70	98	2.1

### Technical characteristics p. 349

Pack	Cat.Nos	Industrial warning devices 110 dB IP 20 - IK 08					
		Frequency 350/400 Hz, continuous sound Operates intermittently: 1 min on / 10 min off					
1	0 415 20	24 V~ and = power supply		Consumption in mA 820			
1	0 415 23	230 V~ power supply		120			
		<b>Electromechanical sirens IP 30 - IK 05</b> Supplied with screws for semi-flush mounting					
		<b>D.C. current</b>					
1	0 415 32	Voltage = 12 V	Power (W) 11	Consumption (mA) 889	Average acoustic output at 1 m (dB) 98	Weight (kg) 0.2	Max. continuous rating (hr) 200
1	0 415 33	24 V	12	516	100	0.2	200
		<b>A.C. current - 50/60 Hz</b>					
1	0 415 36	Voltage ~ 24 V	Power (W) 12.5	Consumption (mA) 531	Average acoustic output at 1 m (dB) 100	Weight (kg) 0.2	Max. continuous rating (hr) 200
1	0 415 38	110 V	70	400	105	0.35	100
1	0 415 39	230 V	57	250	105	0.35	100
		<b>Multi-sound electronic sirens</b> 97 to 106 dB 16 electronic sounds possible for identification of each defined event Easy to identify and select sounds for each appliance using coded wheel Adjustable sound level					
1	0 415 45	230 V~, IP 44 - IK 07					

## Illuminated signalling



0 413 08



0 413 14

Pack	Cat.Nos	Rotating lights	
1	0 413 08	Halogen lamp 20 W (supplied) Light intensity: 1 500 Cd (p) Screw-mounting Dim.: height 185 mm, Ø140 mm IP 65 - IK 10 230 V~, orange	Consumption (mA) 100
10	0 413 62	BA9 S H 12 V - 20 W: rotating lights Cat.No 0 413 08	
1	0 413 57	<b>LEDs flashing light</b> LED light intensity equivalent to Xenon lamp 2 joules Screw-mounting Dim.: height 185 mm, Ø140 mm IP 65 - IK 10 230 V~, red	Consumption (mA) 60
1	0 413 09	<b>Blinking or steady lights</b> <b>Environmental high quality LEDs</b> Screw-mounting Dim. height: 85 mm, Ø105 mm Equipped with 16 LEDs Ø5 mm, high brightness, low consumption Light intensity: 55 Cd(p) Colour and voltage (V~)	Consumption (mA) 300
1	0 413 13	Red, 12/24 V~/=	300
1	0 413 10	Orange, 230 V~	20
1	0 413 14	Red, 230 V~	20

## Electromechanical sirens

### Dimensions

#### Electromechanical sirens

Cat.Nos 0 415 32/33/36/38/39

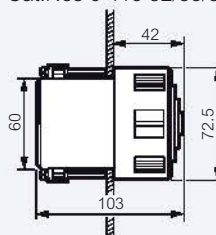

#### Multi-sound electronic sirens

Cat.No 0 415 45

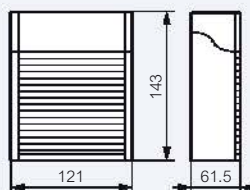

### Selection chart of sounds (Cat.No 0 415 45)

Type of signal	Exemple of application	Position of code	Sound level (in Db at 1m)		Frequency in Hz	Consumption in mA
			max.	min.		
Danger	Moving equipment or vehicle	0	98	68	2400 to 2800	70
		1	102	73	1000 to 1500	45
	Interruption of a dangerous manufacturing process	2	98	70	2400 to 2800	75
		3	98	70	2400 to 2800	50
		4	99	72	2400 to 2800	100
		5	104	75	2400 to 2800	100
Defect	Interruption of a non-dangerous manufacturing process	6	102	70	1000 to 1500	30
		7	97	68	1000 to 1500	30
		8	101	73	1000 to 1500	50
		9	101	73	1000 to 1500	50
		A	102	74	1000 to 1500	30
		B	99	70	554	20
Miscellaneous	Access to a school, a work shop	C	102	74	3000	100
Evacuation	Fire	D	98	69	440 to 554	20
Intrusion	Inside alarm	E	106	81	3200 / 3700	130
	Outside alarm	F	104	77	1400 / 1600	50

# ARTEOR WIRING ACCESSORIES



**P. 360**  
Mechanical switches



**P. 367**  
Lighting control,  
emergency  
push-buttons



**P. 372**  
USB chargers



**P. 378**  
Adaptors  
for data sockets  
and USB  
data sockets



**Support frames  
and plates**

**P. 385**  
International  
support  
frames



**Hotel equipment**

**NEW**  
**P. 395**  
BUS/SCS  
devices

## NEW PRODUCTS 2014



**Universal  
dimmers**  
(p. 364)



**Hotel equipment**  
BUS/SCS wiring  
accessories  
(p. 395)





**P. 362**  
Electronic switches



**P. 363**  
Push-buttons



**NEW**  
**P. 364**  
Dimmers



**P. 366**  
Automatic switches and visual indication



**P. 367**  
DP switches, cooker control units



**P. 368**  
Ventilation, heating and roller blinds control RCBO and MCB



**P. 369**  
British standard socket outlets



**P. 370**  
International socket outlets



**P. 374**  
Television and telephone sockets



**P. 375**  
RJ 45 sockets and data sockets



**P. 376**  
Data sockets, wiring splitter and Ethernet switches



**P. 377**  
Wi-Fi access points



**P. 379**  
Attenuators and loudspeaker sockets



**P. 381**  
Audio and video sockets



**P. 383**  
Blanking plates and mounting boxes

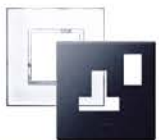

**P. 386**  
British standard plates



**P. 388**  
Italian/US standard plates



**P. 390**  
American and South African standard plates



**P. 392**  
German and French standard plates



**NEW**  
**P. 396**  
KNX devices



**P. 397**  
Wiring devices



**P. 398**  
Square version mechanisms



**P. 399**  
Round version mechanisms



## Hotel equipment

### KNX wiring accessories (p. 396)















Mechanisms supplied with white or magnesium square rocker plate, to be equipped with support frames and plates (p. 358)				Mechanisms supplied with white or magnesium square rocker plate, to be equipped with support frames and plates (p. 358)			
		White	Magnesium			White	Magnesium
<b>SWITCHES 10 AX - 250 V~</b>				<b>SENSITIVE SWITCH 100/240 V~</b>			
	1-way switch	5 720 04	5 725 04		For controlling light sources by simply passing the hand in front of the switch	5 720 51	5 734 55
	2-way switch	5 720 05	5 725 05				
	Intermediate switch	5 720 08	5 725 08				
	1-way switch	5 724 50		<b>PUSH-BUTTONS 6 A - 250 V~</b>			
	2-way switch with indicator To be equipped with LED	5 720 06	5 725 06		1-way push-button 2-way push-button	5 720 00 5 720 01	5 725 00 5 725 01
	1-way switch	5 720 34	5 725 34		1-way push-button with bell symbol	5 720 15	5 725 15
	2-way switch	5 720 35	5 725 35		2-way push-button with locator Equipped with blue LED	5 720 02	5 725 02
	Intermediate switch	5 720 38	5 725 38		2-way push-button with label-holder	5 720 03	5 725 03
	2-way switch with indicator To be equipped with LED	5 720 36	5 725 36		Push-button with locator and bell symbol Equipped with blue LED	5 720 16	5 725 16
	2-way switch with indicator and label-holder To be equipped with LED	5 720 37	5 725 37		1-way push-button 2-way push-button	5 720 30 5 720 31	5 725 30 5 725 31
	Double pole switch	5 720 40	5 725 40		1-way push-button with bell symbol	5 720 56	5 725 56
<b>SWITCHES 20 AX - 250 V~</b>				<b>DIMMERS 100/240 V~ - 50/60 Hz</b>			
	1-way switch	5 720 09	5 725 09		Leading edge dimmer Without neutral - 400 W	5 722 13	5 727 13
	2-way switch	5 720 10	5 725 10		Rotary dimmer		
	2-way switch with indicator To be equipped with LED	5 720 11	5 725 11		Universal dimmer Without neutral - 400 W	5 722 39	5 727 39
	1-way - double pole switch	5 720 13	5 725 13				
	Double pole switch	5 724 51					
	1-way - double pole switch with indicator - Red LED supplied	5 720 14	5 725 14				
	1-way switch	5 720 41	5 725 41				
	1-way switch - 3 gang	5 720 43	5 725 43				
	2 x 2-way switch + 1-way switch	5 720 44	5 725 44				
	3 gang						
	2-way switch with indicator To be equipped with LED	5 720 42	5 725 42				
	1-way - Double pole switch	5 720 46	5 725 46				
	2-way - Double pole switch	5 720 48	5 725 48				
	1-way - double pole switch with indicator - Red LED supplied	5 720 47	5 725 47				
	1-way - double pole switch with indicator and "WATER HEATER" marking - Red LED supplied	5 720 49	5 725 49				







Mechanisms supplied with white or magnesium square rocker plate, to be equipped with support frames and plates (p. 358)		White	Magnesium	Mechanisms supplied with white or magnesium square rocker plate, to be equipped with support frames and plates (p. 358)		White	Magnesium
<b>DOUBLE POLE SWITCHES 250 V~</b>				<b>VISUAL INDICATION</b>			
	DP switch 40 A DP switch 40 A + neon	5 720 81 5 720 82	5 725 81 5 725 82		Miniature emergency lighting unit	5 722 22	-
	DP switch 45 A + neon 2 gang	5 720 80	5 725 80		Illuminated lighting unit	5 724 52	-
	DP switch 45 A + neon 1 gang	5 720 87	5 725 87		Overdoor lighting unit - red diffuser - white diffuser	5 724 53 5 722 23	- -
<b>COOKER CONTROL UNIT</b>				<b>VENTILATION AND HEATING CONTROLLER</b>			
	45 A DP switch	5 720 88	-		Fan controller - AC speed control 4 positions	5 722 17	5 727 17
<b>LIGHTING CONTROL</b>					Rotary speed controller for fan 40 to 400 VA	5 722 18	5 727 18
	Time delay switch	5 720 55	5 740 84		Fan step regulator - 100 W	5 722 15	5 727 15
	Single pole latching relay	5 722 27	5 727 27		Electronic room thermostat	5 722 03	5 727 03
<b>EMERGENCY STOP MUSHROOM HEAD PUSH-BUTTONS</b>					Thermostat for electronic floor heating	5 722 63	5 727 63
	Emergency stop mushroom head with key	5 723 63	-	<b>ROLLER BLINDS CONTROL</b>			
	Emergency stop mushroom head 1/4 turn	5 723 62	-		Double push-button - 10 A	5 722 19	5 727 19
					Double switch - 10 A	5 722 20	5 727 20

Mechanisms supplied with white or magnesium square rocker plate, to be equipped with support frames and plates (p. 358)				Mechanisms supplied with white or magnesium square rocker plate, to be equipped with support frames and plates (p. 358)			
BRITISH STANDARD SOCKET OUTLETS		White	Magnesium	FUSED CONNECTION UNITS		White	Magnesium
	2P+E - 5 A	5 721 10	5 726 10		DP fused 13 A switched switched + neon	5 721 50 5 721 51	5 726 50 5 726 51
	2P+E - 13 A	5 721 11	5 726 11	<b>GERMAN STANDARD SOCKET OUTLETS</b>			
	2P+E switched - 13 A	5 721 30	5 726 30		2P+E - 16 A	5 721 18	5 726 18
	2P+E switched dedicated non standard pin - 13 A	5 724 67			2P+E - 16 A - dedicated red	5 724 63	
	2P+E switched - 15 A	5 721 32	5 726 32		2P+E - 16 A - dedicated green	5 724 62	
	2P+E single pole socket 13 A - 1 gang switched switched + neon	5 721 43 5 721 44	5 726 43 5 726 44		2P+E - 16 A - dedicated orange	5 724 60	
	2P+E single pole socket 13 A - 2 gang switched switched + neon	5 721 45 5 721 46	5 726 45 5 726 46		2P+E with cover - 16 A	5 721 19	5 726 19
	2P+E double pole switched socket 5 A - 1 gang	5 721 40	5 726 40	<b>EURO-US TYPE SOCKET OUTLETS</b>			
	2P+E double pole switched socket 13 A - 1 gang	5 721 47	5 726 47		2P	5 721 04	5 726 04
	2P+E double pole switched socket 13 A - 2 gang	5 721 49	5 726 49		2P+E	5 721 16	5 726 16
	2P+E double pole switched socket 13 A - 2 gang switched for standard and clean earth applications	5 721 41			2 x 2P+E	5 721 33	5 726 33

Mechanisms supplied with white or magnesium square rocker plate, to be equipped with support frames and plates (p. 358)				Mechanisms supplied with white or magnesium square rocker plate, to be equipped with support frames and plates (p. 358)			
		White	Magnesium			White	Magnesium
<b>AMERICAN TYPE SOCKET OUTLETS</b>				<b>AUSTRALIAN TYPE SOCKET OUTLETS</b>			
	2P	5 721 05	5 726 05		2P+E auto switched - 10 A	5 721 14	5 726 14
	2P+E	5 721 17	5 726 17		2P+E - 10/15 A	5 721 12	5 726 12
	2 x 2P+E	5 721 34	5 726 34	<b>ISRAEL TYPE SOCKET OUTLETS</b>			
<b>SOUTH AFRICAN TYPE SOCKET OUTLETS</b>					2P+E shuttered for child safety	5 721 24	5 726 24
	2P+E switched	5 721 32	5 726 32	<b>CHINA TYPE SOCKET OUTLETS</b>			
	2P+E dedicated switched	5 724 65			2P+E - 10 A 2P+E - 16 A	5 721 13 5 721 21	5 726 13 5 726 21
	2 x 2P+E switched - 2 gang - pre-wired	5 720 22	5 725 22		2P+E China + 2P Euro-US - 10 A	5 721 31	5 726 31
<b>MULTISTANDARD SOCKET OUTLETS</b>				<b>ELV SOCKET OUTLETS</b>			
	Unswitched	5 721 23	5 726 23		2P - 3A	5 721 00	5 726 00
	Switched	5 721 35	5 726 35	<b>FRENCH STANDARD SOCKET OUTLETS</b>			
<b>ITALIAN TYPE SOCKET OUTLETS</b>					2P shuttered for child safety - 10/16 A	5 720 20	5 725 20
	2P+E on line - 10 A	5 721 01	5 726 01		2P+E shuttered for child safety - 10/16 A	5 720 21	5 725 21
	2P+E shuttered for child safety 10/16 A	5 721 03	5 726 03		2P+E tamperproof	5 724 66	
<b>SWISS TYPE SOCKET OUTLETS</b>					Tamperproof insert	0 502 99	
	2P+E - 10/16 A - type 12	5 721 02	-				
	2P+E - 10 A - type 13	5 721 15	-				





















Mechanisms supplied with white or magnesium square rocker plate, to be equipped with support frames and plates (p. 358)				Mechanisms supplied with white or magnesium square rocker plate, to be equipped with support frames and plates (p. 358)			
		White	Magnesium			White	Magnesium
<b>RJ 45 SOCKETS - CAT. 6A</b>				<b>RJ 45 SOCKETS - CAT. 6 (continued)</b>			
	STP	5 723 06	5 728 06		FTP	5 723 22	5 728 22
	STP - with green shutter	5 723 52	5 728 52		FTP	5 723 16	5 728 16
	STP - with orange shutter	5 723 51	5 728 51	<b>RJ 45 SOCKETS - CAT. 5E</b>			
	STP - with controlled access	5 723 50	5 728 50		UTP	5 723 03	5 728 03
	UTP	5 723 49	5 728 49		UTP	5 723 15	5 728 15
	UTP - with green shutter	5 723 59	5 728 59		FTP	5 723 04	5 728 04
	UTP - with orange shutter	5 723 58	5 728 58	<b>REAR PLUGGABLE RJ 45 SOCKETS</b>			
	UTP - with controlled access	5 723 57	5 728 57		Cat. 6 - UTP Cat. 6 - FTP	5 723 31 5 723 33	5 728 31 5 728 33
<b>RJ 45 SOCKETS - CAT. 6</b>					Cat. 5e - UTP Cat. 5e - FTP	5 723 30 5 723 32	5 728 30 5 728 32
	STP shielded	5 723 23	5 728 23	<b>TELEPHONE/ETHERNET WIRING SPLITTERS</b>			
	STP shielded	5 723 17	5 728 17		FTP double connector	5 723 36	5 728 36
	UTP	5 723 02	5 728 02		UTP double connector	5 723 35	5 728 35
	UTP - with green shutter	5 723 55	5 728 55	<b>TELEVISION SOCKETS</b>			
	UTP - with orange shutter	5 723 54	5 728 54		TV-R-SAT socket	5 721 72	5 726 72
	UTP	5 723 14	5 728 14		TV-R socket	5 721 70	5 726 70
	UTP - with controlled access	5 723 53	5 728 53		TV single shielded male $\varnothing 9.5$ mm	5 721 71	5 726 71
	UTP retractable RJ 45	5 723 39	5 728 39		TV single shielded "F" type	5 721 63	5 726 63

Mechanisms supplied with white or magnesium square rocker plate, to be equipped with support frames and plates (p. 358)		 White	 Magnesium
<b>TELEPHONE SOCKETS</b>			
	RJ 11 - 4 contacts	5 723 00	5 728 00
	RJ 11 - 4 contacts	5 723 13	5 728 13
	RJ 12 - 6 contacts	5 723 12	5 728 12
	Single master	5 723 10	5 728 10
	Single secondary	5 723 01	5 728 01
<b>BLANK MODULES</b>			
	1 module	5 723 41	5 728 41
	2 modules	5 723 42	5 728 42
	3 modules	5 723 43	5 728 43
<b>CABLE OUTLETS</b>			
	20 A - for junction	5 723 20	-
	45 A - BS 1 gang	5 723 21	-
<b>CORD OUTLETS</b>			
	1 module - with Ø8 mm entry	5 723 07	-
	2 modules	5 723 19	-

BLANKING COVER PLATES		 White	 Magnesium
<b>BRITISH STANDARD</b>			
	For 1 gang box ○ White ● Pearl Alu ● Graphite		5 751 30 5 751 31 5 751 32
	For 2 gang box ○ White ● Pearl Alu ● Graphite		5 751 40 5 751 41 5 751 42
<b>ITALIAN/US STANDARD</b>			
	For 2" x 4" boxes ○ White ● Pearl Alu ● Graphite		5 754 10 5 754 11 5 754 12
<b>US STANDARD</b>			
	For 4" x 4" boxes ○ White ● Pearl Alu ● Graphite		5 753 60 5 753 61 5 753 62

Number of modules per mechanism	Flush-mounting boxes	Support frames	Plates	PLATES			
				White	Neutral	Graphite	Tattoo
							
<b>BRITISH STANDARD - 60.3 MM FIXING CENTRES</b>							
1 module	1 gang	5 760 03		5 752 00	5 752 01	5 752 02	5 761 08
2 modules and 1.2" touch screen		5 760 03		5 752 10	5 752 11	5 752 12	5 761 28
3 modules - 1 gang	1 gang	5 760 01		5 751 60	5 751 61	5 751 62	5 761 88
3 modules and shaver sockets	2 gang	5 760 02		5 750 70	5 750 71	5 750 72	5 761 68
4 modules	2 gang	5 760 00		5 750 80	5 750 81	5 750 82	5 761 48
6 modules	6 890 36	Supplied with support frame		5 753 70	5 753 71	5 753 72	5 763 78
8 modules	6 890 38	Supplied with support frame		5 767 00	5 767 01	5 767 02	5 767 18
2 x 6 modules	6 890 28	Supplied with support frame		5 753 90	5 753 91	5 753 92	-
3 x 6 modules	0 818 56	Supplied with support frame		5 754 00	5 754 01	5 754 02	-
For 5 A/13 A switched socket outlet - 1 gang	-	Not needed		5 750 90	5 750 91	5 750 92	5 762 18
For 13 A twin Switched socket outlet - 2 gang	-	Not needed		5 751 00	5 751 01	5 751 02	5 762 08
For 13 A fused connection unit switched	-	Not needed		5 751 20	5 751 21	5 751 22	5 761 98
For cooker unit Cat.No 5 720 88	-	Not needed		5 751 50	-	-	-
Blanking cover plate	1 gang	5 760 03 5 760 01		5 751 30	5 751 31	5 751 32	-
	2 gang	5 760 02		5 751 40	5 751 41	5 751 42	-
<b>ITALIAN OR US STANDARDS - 83.5 MM FIXING CENTRES</b>							
1 module	0 800 49	5 760 40		5 752 20	5 752 21	5 752 22	5 764 18
2 modules and 1.2" touch screen	0 800 49	5 760 40		5 752 30	5 752 31	5 752 32	5 764 38
3 modules	0 800 49	5 760 40		5 750 10	5 750 11	5 750 12	5 764 58
4 modules	0 800 42	5 760 11		5 750 30	5 750 31	5 750 32	5 762 78
6 modules	0 800 43	5 760 12		5 750 40	5 750 41	5 750 42	5 762 88
Blanking cover plate	2" x 4"	5 760 40		5 754 10	5 754 11	5 754 12	-



Number of modules per mechanism	Flush-mounting boxes	Support frames	Plates	PLATES			
				White	Neutral	Graphite	Tattoo
							
<b>AMERICAN STANDARD - 83.5 MM FIXING CENTRES (SOUTH AFRICAN STANDARD p. 390)</b>							
1 module	2" x 4"	5 760 40		5 752 40	5 752 41	5 752 42	5 764 18
2 modules and 1.2" touch screen		5 760 40		5 752 50	5 752 51	5 752 52	5 764 38
3 modules		5 760 40		5 752 70	5 752 71	5 752 72	5 764 58
2 modules	4" x 4"	5 760 31		5 752 60	5 752 61	5 752 62	5 766 28
3 modules		5 760 31		5 752 80	5 752 81	5 752 82	5 766 48
4 modules		5 760 31		5 752 90	5 752 91	5 752 92	5 766 58
2 x 3 modules		5 760 32		5 753 00	5 753 01	5 753 02	5 766 78
Blanking cover plates	2" x 4"	5 760 40		5 754 10	5 754 11	5 754 12	-
	4" x 4"	5 760 31		5 753 60	5 753 61	5 753 62	-
<b>FRENCH AND GERMAN STANDARD - 60 MM FIXING CENTRES</b>							
1 module	0 800 41	5 760 21 (screws) 5 760 20 (claws)		5 765 40	5 765 41	5 765 52	5 762 28
2 modules and 1.2" touch screen	0 800 41	5 760 21 (screws) 5 760 20 (claws)		5 765 60	5 765 61	5 765 62	5 762 48
3 modules	0 800 49	5 760 40		5 750 10	5 750 11	5 750 12	5 764 58
4 modules	0 800 42	5 760 11		5 750 30	5 750 31	5 750 32	5 762 78
2 x 2 modules	0 800 42	2 x 5 760 21		5 750 20	5 750 21	5 750 22	5 762 68
6 modules	0 800 43	5 760 12		5 750 40	5 750 41	5 750 42	5 762 88
2 x 6 modules	0 801 26	5 760 22		5 750 60	5 750 61	5 750 62	-
3 x 2 modules	0 800 43	3 x 5 760 21		5 750 50	5 750 51	5 750 52	-

# Arteor™ mechanical switches

square version



Support frame and plate selection charts **p. 386-393**

Mechanisms supplied with rocker plates, to be equipped with support frames (p. 385) and plates (p. 386 to 393)

Pack	Cat.Nos	Switches 10 AX - 250 V~	Pack	Cat.Nos	Switches 20 AX - 250 V~ (continued)
10	5 720 04	<b>1-way switch</b> ○ White - 1 module	10	5 720 11	<b>2-way switch with indicator</b> To be equipped with LED (p. 366) ○ White - 1 module
10	5 725 04	● Magnesium - 1 module	5	5 725 11	● Magnesium - 1 module
10	5 724 50	● Red - 1 module	10	5 720 42	○ White - 2 modules
10	5 720 34	○ White - 2 modules	5	5 725 42	● Magnesium - 2 modules
10	5 725 34	● Magnesium - 2 modules	10	5 720 43	<b>1-way switch - 3 gang</b> ○ White - 2 modules
10	5 720 05	<b>2-way switch</b> ○ White - 1 module	10	5 725 43	● Magnesium - 2 modules
10	5 725 05	● Magnesium - 1 module	10	5 720 44	<b>2 x 2-way switch + 1-way switch - 3 gang</b> ○ White - 2 modules
10	5 720 35	○ White - 2 modules	10	5 725 44	● Magnesium - 2 modules
10	5 725 35	● Magnesium - 2 modules	5	5 720 13	<b>1-way double pole switch</b> ○ White - 1 module
10	5 720 06	<b>2-way switch with indicator</b> To be equipped with LED (p. 366) ○ White - 1 module	5	5 725 13	● Magnesium - 1 module
10	5 725 06	● Magnesium - 1 module	5	5 724 51	● Red - 1 module
5	5 720 36	○ White - 2 modules	10	5 720 46	○ White - 2 modules
5	5 725 36	● Magnesium - 2 modules	10	5 725 46	● Magnesium - 2 modules
5	5 720 37	<b>2-way switch with indicator and label-holder</b> To be equipped with LED (p. 366) ○ White - 2 modules	5	5 720 14	<b>1-way double pole switch with indicator</b> Red LED supplied ○ White - 1 module
5	5 725 37	● Magnesium - 2 modules	5	5 725 14	● Magnesium - 1 module
5	5 720 08	<b>Intermediate switch</b> ○ White - 1 module	10	5 720 47	○ White - 2 modules
5	5 725 08	● Magnesium - 1 module	10	5 725 47	● Magnesium - 2 modules
10	5 720 38	○ White - 2 modules	10	5 720 49	<b>1-way double pole switch with indicator and "WATER HEATER" marking</b> Red LED supplied ○ White - 2 modules
10	5 725 38	● Magnesium - 2 modules	10	5 725 49	● Magnesium - 2 modules
10	5 720 40	<b>Double pole switch</b> ○ White - 2 modules	10	5 720 48	<b>2-way double pole switch</b> ○ White - 2 modules
5	5 725 40	● Magnesium - 2 modules	10	5 725 48	● Magnesium - 2 modules
10	5 720 09	<b>Switches 20 AX - 250 V~</b> <b>1-way switch</b> ○ White - 1 module			
10	5 725 09	● Magnesium - 1 module			
10	5 720 41	○ White - 2 modules			
10	5 725 41	● Magnesium - 2 modules			
10	5 720 10	<b>2-way switch</b> ○ White - 1 module			
10	5 725 10	● Magnesium - 1 module			

Support frames and plates, **p. 385-393**



# Arteor™ mechanical switches

## round version



5 731 10    5 731 11    5 731 12    5 730 62    5 731 26    5 731 28    5 730 72

Support frame and plate selection charts **p. 386-393**

Mechanisms supplied with rocker plates, to be equipped with support frames (p. 385) and plates (p. 386 to 393)

Pack	Cat.Nos	Switches 10 AX - 250 V~	Pack	Cat.Nos	Switches 20 AX - 250 V~ (continued)
10	5 730 10	<b>1-way switch</b> ○ White - 1 left module	10	5 730 23	<b>2-way switch</b> ○ White - 1 left module
10	5 731 10	● Magnesium - 1 left module	10	5 731 23	● Magnesium - 1 left module
10	5 730 11	○ White - 1 middle module	10	5 730 24	○ White - 1 middle module
10	5 731 11	● Magnesium - 1 middle module	10	5 731 24	● Magnesium - 1 middle module
10	5 730 12	○ White - 1 right module	10	5 730 25	○ White - 1 right module
10	5 731 12	● Magnesium - 1 right module	10	5 731 25	● Magnesium - 1 right module
10	5 730 60	○ White - 2 modules			<b>2-way switch with indicator</b> To be equipped with LED (p. 366)
10	5 731 60	● Magnesium - 2 modules	5	5 730 26	○ White - 1 left module
		<b>2-way switch</b>	5	5 731 26	● Magnesium - 1 left module
10	5 730 13	○ White - 1 left module	5	5 730 28	○ White - 1 right module
10	5 731 13	● Magnesium - 1 left module	5	5 731 28	● Magnesium - 1 right module
10	5 730 14	○ White - 1 middle module	5	5 730 71	○ White - 2 modules
10	5 731 14	● Magnesium - 1 middle module	5	5 731 71	● Magnesium - 2 modules
10	5 730 15	○ White - 1 right module			<b>1-way switch - 3 gang</b>
10	5 731 15	● Magnesium - 1 right module	10	5 730 72	○ White - 2 modules
10	5 730 61	○ White - 2 modules	5	5 731 72	● Magnesium - 2 modules
10	5 731 61	● Magnesium - 2 modules			<b>2 x 2-way switch + 1-way switch - 3 gang</b>
		<b>2-way switch with indicator</b> To be equipped with LED (p. 366)	10	5 730 73	○ White - 2 modules
5	5 730 16	○ White - 1 left module	10	5 731 73	● Magnesium - 2 modules
5	5 731 16	● Magnesium - 1 left module			<b>1-way double pole switch</b>
5	5 730 17	○ White - 1 middle module	5	5 730 30	○ White - 1 left module
5	5 731 17	● Magnesium - 1 middle module	5	5 731 30	● Magnesium - 1 left module
5	5 730 18	○ White - 1 right module	5	5 730 31	○ White - 1 right module
5	5 731 18	● Magnesium - 1 right module	5	5 731 31	● Magnesium - 1 right module
5	5 730 62	○ White - 2 modules	10	5 730 75	○ White - 2 modules
5	5 731 62	● Magnesium - 2 modules	10	5 731 75	● Magnesium - 2 modules
		<b>Intermediate switch</b>			<b>1-way double pole switch with indicator</b> Red LED supplied
10	5 730 63	○ White - 2 modules	5	5 730 32	○ White - 1 left module
5	5 731 63	● Magnesium - 2 modules	5	5 731 32	● Magnesium - 1 left module
		<b>Double pole switch</b>	5	5 730 33	○ White - 1 right module
5	5 730 65	○ White - 2 modules	5	5 731 33	● Magnesium - 1 right module
5	5 731 65	● Magnesium - 2 modules	10	5 730 76	○ White - 2 modules
		<b>Switches 20 AX - 250 V~</b>	10	5 731 76	● Magnesium - 2 modules
10	5 730 20	<b>1-way switch</b> ○ White - 1 left module			<b>1-way double pole switch with indicator and "WATER HEATER" marking</b> Red LED supplied
10	5 731 20	● Magnesium - 1 left module	10	5 730 78	○ White - 2 modules
10	5 730 21	○ White - 1 middle module	10	5 731 78	● Magnesium - 2 modules
10	5 731 21	● Magnesium - 1 middle module			<b>2-way double pole switch</b>
10	5 730 22	○ White - 1 right module	10	5 730 77	○ White - 2 modules
10	5 731 22	● Magnesium - 1 right module	5	5 731 77	● Magnesium - 2 modules
10	5 730 70	○ White - 2 modules			
10	5 731 70	● Magnesium - 2 modules			

## Arteor™ electronic switches

square version



Support frame and plate selection charts **p. 386-393**  
Load selection charts **p. 365**

Mechanisms supplied with rocker plates, to be equipped with support frames (p. 385) and plates (p. 386 to 393)

Pack	Cat.Nos	<b>Micropush switches without neutral - 100/240 V~</b>
1	5 740 02	<b>2-way switch - 2 x 400 W with LED locator</b> With magnesium control touch Supplied with support frame ● White - 2 modules ● Black - 2 modules
1	5 740 52	

1	5 740 03	<b>Micropush switches with neutral - 100/240 V~</b> With Magnesium control touch <b>2-way switch - 1000 W with LED locator</b> ● White - 2 modules ● Black - 2 modules
1	5 740 53	
1	5 740 00	<b>2-way switch - 2 x 1000 W with LED locator</b> ● White - 2 modules ● Black - 2 modules
1	5 740 50	
1	5 740 01	<b>2-way switch - 3 x 1000 W with LED locator</b> ● White - 2 modules ● Black - 2 modules
1	5 740 51	

1	5 720 51	<b>Sensitive switches - 100/240 V~</b> For controlling light sources by simply passing the hand in front of the switch (distance 5 mm) Up to 5 sensitive switches can be combined to control the same lighting circuit Supplied with LED indicator light ● White - 2 modules ● Magnesium - 2 modules
1	5 734 55	

## Arteor™ electronic switches

round version



Support frame and plate selection charts **p. 386-393**  
Load selection charts **p. 365**

Mechanisms supplied with rocker plates, to be equipped with support frames (p. 385) and plates (p. 386 to 393)

Pack	Cat.Nos	<b>Micropush switches without neutral - 100/240 V~</b>
1	5 743 02	<b>2-way switch - 2 x 400 W with LED locator</b> With magnesium circle for control Supplied with support frame ● White - 2 modules ● Black - 2 modules
1	5 743 52	

1	5 743 03	<b>Micropush switches with neutral - 100/240 V~</b> With Magnesium circle for control <b>2-way switch - 1000 W with LED locator</b> ● White - 2 modules ● Black - 2 modules
1	5 743 53	
1	5 743 00	<b>2-way switch - 2 x 1000 W with LED locator</b> ● White - 2 modules ● Black - 2 modules
1	5 743 50	
1	5 743 01	<b>2-way switch - 3 x 1000 W with LED locator</b> ● White - 2 modules ● Black - 2 modules
1	5 743 51	

1	5 725 51	<b>Sensitive switches - 100/240 V~</b> For controlling light sources by simply passing the hand in front of the switch (distance 5 mm) Up to 5 sensitive switches can be combined to control the same lighting circuit Supplied with LED indicator light ● White - 2 modules ● Magnesium - 2 modules
1	5 736 55	

## Arteor™ push-buttons

square version



5 720 15    5 725 16    5 725 33

Support frame and plate selection charts **p. 386-393**

Mechanisms supplied with rocker plates, to be equipped with support frames (p. 385) and plates (p. 386 to 393)

Pack	Cat.Nos	Push-buttons 6 A - 250 V~
10	5 720 00	<b>1-way push-button</b> ○ White - 1 module
10	5 725 00	● Magnesium - 1 module
10	5 720 30	○ White - 2 modules
10	5 725 30	● Magnesium - 2 modules
5	5 720 15	<b>1-way push-button with bell symbol</b> ○ White - 1 module
5	5 725 15	● Magnesium - 1 module
5	5 720 56	○ White - 2 modules
5	5 725 56	● Magnesium - 2 modules
5	5 720 16	<b>1-way push-button with locator and bell symbol</b> Equipped with blue LED ○ White - 1 module
5	5 725 16	● Magnesium - 1 module
10	5 720 01	<b>2-way push-button</b> ○ White - 1 module
5	5 725 01	● Magnesium - 1 module
10	5 720 31	○ White - 2 modules
5	5 725 31	● Magnesium - 2 modules
10	5 720 02	<b>2-way push-button with locator</b> Equipped with blue LED ○ White - 1 module
10	5 725 02	● Magnesium - 1 module
10	5 720 32	○ White - 2 modules
5	5 725 32	● Magnesium - 2 modules
10	5 720 03	<b>2-way push-button with label-holder</b> ○ White - 1 module
5	5 725 03	● Magnesium - 1 module
10	5 720 33	○ White - 2 modules
10	5 725 33	● Magnesium - 2 modules

## Arteor™ push-buttons

round version



5 730 00    5 730 01    5 730 02    5 730 52    5 731 52

Support frame and plate selection charts **p. 386-393**

Mechanisms supplied with rocker plates, to be equipped with support frames (p. 385) and plates (p. 386 to 393)

Pack	Cat.Nos	Push-buttons 6 A - 250 V~
10	5 730 00	<b>1-way push-button</b> ○ White - 1 left module
10	5 731 00	● Magnesium - 1 left module
10	5 730 01	○ White - 1 middle module
10	5 731 01	● Magnesium - 1 middle module
10	5 730 02	○ White - 1 right module
10	5 731 02	● Magnesium - 1 right module
10	5 730 50	○ White - 2 modules
10	5 731 50	● Magnesium - 2 modules
5	5 730 80	<b>1-way push-button with bell symbol</b> ○ White - 2 modules
5	5 731 80	● Magnesium - 2 modules
5	5 730 51	<b>2-way push-button</b> ○ White - 2 modules
5	5 731 51	● Magnesium - 2 modules
5	5 730 52	<b>2-way push-button with locator</b> Equipped with blue LED ○ White - 2 modules
5	5 731 52	● Magnesium - 2 modules
10	5 730 53	<b>2-way push-button with label-holder</b> ○ White - 2 modules
5	5 731 53	● Magnesium - 2 modules

# Arteor™ dimmers





square version





Support frame and plate selection charts **p. 386-393**  
 Load selection charts **p. 365**

Mechanisms supplied with rocker plates, to be equipped with support frames (p. 385) and plates (p. 386 to 393)  
 100/240 VA - 50/60 Hz

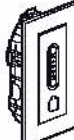
## Pack Cat.Nos Resistive/inductive loads touch dimmers

1	5 722 11	<p>Without neutral, 2-wire</p> <p><b>Push-button dimmer - 600 W</b>          To be installed alone in a 3 module box with a 3-module support frame and a 2-module plate</p> <p>○ White - 2 modules          ● Magnesium - 2 modules</p> 
1	5 727 11	
1	5 722 13	<p><b>Leading edge dimmers</b></p> <p>Without neutral, 2-wire</p> <p><b>Rotary dimmer - 400 W</b>          ○ White - 2 modules          ● Magnesium - 2 modules</p> 
1	5 727 13	
1	5 735 01	<p><b>Rotary dimmer - 1000 W</b>          To be installed alone in a 3 module box (or 1 gang BS) with a 3-module support frame and a 2-module plate          For lamps:          - 60-1000 W (230 V) - 60-500 W (127 V) for incandescent and halogen lamps          - 60-600 VA (230 V) - 60-300 VA (127 V) for halogen lamps with electronic transformer with leading edge behaviour          - 60-1000 VA (230 V) - 60-500 VA (127 V) for halogen lamps with ferromagnetic transformers</p> <p>○ White - 2 modules          ● Magnesium - 2 modules</p> 
1	5 737 01	
1	5 740 07	<p><b>Trailing/leading edge dimmers</b></p> <p><b>Push-button dimmer - 2 x 400 W</b>          With Magnesium control touch          Supplied with support frame</p> <p>○ White - 2 modules          ● Black - 2 modules</p> 
1	5 740 57	
1	5 722 41 <sup>1</sup>	<p><b>Push-button dimmer - 1000 W</b>          Supplied complete with flush-mounting box, support frame and plate. 5 LEDs showing lighting intensity status</p> <p>○ White - 5 vertical modules          ● Magnesium - 5 vertical modules</p> 
1	5 727 41 <sup>2</sup>	

## Pack Cat.Nos Universal dimmers

1	5 722 39	<p>Without neutral, 2 wires</p> <p>Push-button dimmer for all types of lamps:          - Dimmable LEDs: 75 W          - Dimmable compact fluorescent lamps: 75 W          - Halogen with transformer: 400 VA          - Fluorescent tube: 200 VA          - Halogen 230 V and incandescent: 400 W          Can be associated with one or several push-buttons without neon, for ON/OFF or dimming control          Lights come on again at the same lighting level as before they were last switched off</p> <p>○ White - 2 modules          ● Magnesium - 2 modules</p> 
1	5 727 39	
1	5 722 38	<p><b>Dimmers 0-10 V</b></p> <p>Push-button dimmer for ballasts 0-10 V</p> <p>○ White - 2 modules          ● Magnesium - 2 modules</p> 
1	5 727 38	

1: Supplied with White plate  
 2: Supplied with Mirror Black plate

# Arteor™ dimmers

round version



5 743 55



5 743 19



5 743 38

Support frame and plate selection charts **p. 386-393**  
 Load selection charts (**see opposite**)

Mechanisms supplied with rocker plates, to be equipped with support frames (p. 385) and plates (p. 386 to 393)  
 100/240 VA - 50/60 Hz

## Pack Cat.Nos Resistive/inductive loads touch dimmers

Without neutral, 2-wire  
**Push-button dimmer - 600 W**  
 To be installed alone in a 3 module box with a 3-module support frame and a 2-module plate  
 For lamps:  
 ○ White - 2 modules  
 ● Magnesium - 2 modules

1	5 743 05
1	5 743 55

**Leading edge dimmers**  
 Without neutral, 2-wire  
**Rotary dimmer - 1000 W**  
 To be installed alone in a 3 module box (or 1 gang BS) with a 3-module support frame and a 2-module plate  
 For lamps:  
 - 60-1000 W (230 V) - 60-500 W (127 V) for incandescent and halogen lamps  
 - 60-600 VA (230 V) - 60-300 VA (127 V) for halogen lamps with electronic transformer with leading edge behaviour  
 - 60-1000 VA (230 V) - 60-500 VA (127 V) for halogen lamps with ferromagnetic transformers  
 ○ White - 2 modules  
 ● Magnesium - 2 modules

1	5 722 40
1	5 727 40

**Trailing/leading edge dimmers**  
**Push-button dimmer - 2 x 400 W**  
 With Magnesium circle for control  
 Supplied with support frame  
 ○ White - 2 modules  
 ● Black - 2 modules

1	5 743 07
1	5 743 57

**Universal dimmers**  
 Without neutral, 2 wires  
 Push-button dimmer for all types of lamps:  
 - Dimmable LEDs: 75 W  
 - Dimmable compact fluorescent lamps: 75 W  
 - Halogen with transformer: 400 VA  
 - Fluorescent tube: 200 VA  
 - Halogen 230 V and incandescent: 400 W  
 Can be associated with one or several push-buttons without neon, for ON/OFF or dimming control  
 Lights come on again at the same lighting level as before they were last switched off  
 ○ White - 2 modules  
 ● Magnesium - 2 modules

1	<b>N</b> 5 743 19
1	5 743 39

**Dimmers 0-10 V**  
 Push-button dimmer for ballasts 0-10 V  
 ○ White - 2 modules  
 ● Magnesium - 2 modules

1	<b>N</b> 5 743 18
1	5 743 38

# Arteor™ load selection charts

## Load selection charts

	Cat.Nos	Universal							
		Leading edge				Trailing edge			
		Incandescent lamp		Halogen lamp		ELV halogen with ferromagnetic transformer		ELV halogen with electronic transformer	
		110 V	230 V	110 V	230 V	110 V	230 V	110 V	230 V
Micropush switches	5 740 02/52 5 743 02/52	2 x 200 W	2 x 400 W	2 x 200 W	2 x 400 W	2 x 200 VA	2 x 400 VA	2 x 200 VA	2 x 400 VA
	5 740 03/53 5 743 03/53	500 W	1000 W	500 W	1000 W	250 VA	500 VA	250 VA	500 VA
	5 740 00/50 5 743 00/50	2 x 500 W	2 x 1000 W	2 x 500 W	2 x 1000 W	2 x 250 VA	2 x 500 VA	2 x 250 VA	2 x 500 VA
Sensitive switches	5 740 01/51 5 743 01/51	3 x 500 W	3 x 1000 W	3 x 500 W	3 x 1000 W	3 x 250 VA	3 x 500 VA	3 x 250 VA	3 x 500 VA
	5 720 51 5 734 55 5 725 51 5 736 55	500 W	1000 W	500 W	1000 W	250 VA	500 VA	250 VA	500 VA
Dimmers	5 722 13 5 727 13	200 W	400 W	200 W	400 W	200 VA	400 VA		
	5 735 01 5 737 01 5 722 40 5 727 40	500 W	1000 W	500 W	1000 W	500 VA	1000 VA	300 VA	600 VA
	5 722 11 5 727 11 5 743 05/55	300 W	600 W	300 W	600 W	300 VA	600 VA		
	5 722 39 5 727 39 5 743 19 5 743 39	200 W	400 W	200 W	400 W	200 VA	400 VA	200 VA	400 VA
	5 740 07/57 5 743 07/57	2 x 200 W	2 x 400 W	2 x 200 W	2 x 400 W	2 x 200 VA	2 x 400 VA	2 x 200 VA	2 x 400 VA
	5 722 41 5 727 41	500 W	1000 W	500 W	1000 W	500 VA	1000 VA	500 VA	1000 VA

	Cat.Nos	Universal					
		Fluorescent tube		Compact fluorescent lamp		LED	
		110 V	230 V	110 V	230 V	110 V	230 V
Micropush switches	5 740 03/53 5 743 03/53	250 VA	500 VA	250 VA	500 VA	250 VA	500 VA
	5 740 00/50 5 743 00/50	2 x 250 VA	2 x 500 VA	2 x 250 VA	2 x 500 VA	2 x 250 VA	2 x 500 VA
	5 740 01/51 5 743 01/51	3 x 250 VA	3 x 500 VA	3 x 250 VA	3 x 500 VA	3 x 250 VA	3 x 500 VA
Sensitive switches	5 720 51 5 734 55 5 725 51 5 736 55	250 VA	500 VA	250 VA	500 VA	250 VA	500 VA
	5 722 39 5 727 39 5 743 19 5 743 39	100 VA	200 VA	Dimmable 37 W 10 lamps max	Dimmable 75 W 10 lamps max	Dimmable 37 W 10 lamps max	Dimmable 75 W 10 lamps max

	Cat.Nos	Ballasts 0-10 V		Ballasts DALI		Reducer motor for shutters	
		110 V	230 V	110 V	230 V	110 V	230 V
Micropush switches	5 740 02/52 5 743 02/52					50 VA	100 VA
	5 740 03/53 5 743 03/53					2 x 50 VA	2 x 100 VA
	5 740 00/50 5 743 00/50					3 x 50 VA	3 x 100 VA
Sensitive switches	5 720 51 5 734 55 5 725 51 5 736 55					50 VA	100 VA
	5 722 38 5 727 38 5 743 18 5 743 38	300 VA 40 mA	600 VA 40 mA				



 Support frame and plate selection charts **p. 386-393**

Mechanisms supplied with square rocker plates, to be equipped with support frames (p. 385) and plates (p. 386 to 393)

Pack	Cat.Nos	Automatic switches	Pack	Cat.Nos	Miniature emergency lighting unit
1	5 740 47	Measurement of luminosity threshold Adjustment of luminosity threshold and time delay Max. lux and min. time delay factory pre-set Settings modified on the device via thumbwheel or configuration tool Cat.Nos 0 882 30 and 0 882 35 (p. 596) Recommended fixing height: 1 m IR detection 180° Adjustable luminosity threshold: 5 to 1275 lux Time delay adjustable from 5 s to 30 min Consumption 0,2 W on standby Optimum distance between 2 sensors: 6 m Installation in box min. depth 40 mm recommended 2 modules Range 8 m <b>With neutral, 3-wire - 1000 W</b> Operates: - 2000 W incandescent and halogen lamps 230 V~ - 1000 VA ELV halogen lamps with ferromagnetic or electronic transformer - 500 VA compact fluorescent lamps - 0 to 250 W for LEDs ○ White ● Magnesium	1	5 722 22	Illuminates automatically upon power failure Unclips from frame to become portable LEDs indicating mains and charging status 2 modules ○ White 
1	5 740 97		<b>Without neutral, 2-wire, 400 W</b> Operates: - 400 W incandescent and halogen lamps 230 V~ - 400 VA ELV halogen lamps with ferromagnetic or electronic transformer ○ White ● Magnesium	1	5 722 21
1	5 740 34	<b>180° switch sensors</b> Infrared and ultrasonic detection, range 8 m Recommended fixing height: 1.20 m Standby consumption: 0.2 W Optimum distance between 2 sensors: 6 m 3-wire cable IP 41 For installation in box, depth 40 mm min., or in surface-mounting box Cat.No 0 802 81 2 modules <b>Vacancy mode with neutral</b> Dual-tech - Maximum range 8 m - IP 41 ○ White ● Magnesium	1	5 727 26	<b>Illuminated lighting unit</b> 230 V - 1 W Supplied with 4 coloured labels 1 module ○ White 
1	5 740 94		10 5 724 52 <b>Overdoor lighting units</b> Supplied with diffusers and LED 2 modules ○ White with red diffuser ○ White with white diffuser 		
10	5 740 94	10 5 724 53 <b>Lamps</b> <b>For locator switch</b> LED 230 V - blue <b>For indicator switch</b> LED 230 V - red LED 24 V - red LED 12 V - red 			





# Arteor™

## lighting control, emergency push-buttons



Support frame and plate selection charts **p. 386-393**

Mechanisms supplied with rocker plates, to be equipped with support frames (p. 385) and plates (p. 386 to 393)

Pack	Cat.Nos	Time delay switches
1	5 720 55	Interference suppression conforming to standard EN 55022 For timer control of a circuit with the following loads: - 1000 W incandescent and halogen 230 V~ - 2300 W resistive (heating) - 400 VA fluorescent and ELV halogen Adjustable from 25 s to 15 min It is possible to install a number of timer switches in parallel on the same circuit With integrated LED 2-wire installation in box min. depth 40 mm 2 modules ○ White ● Magnesium
1	5 740 84	
1	5 722 27	<b>Single pole latching relays 10 A - 250 V~</b> Used to bring functions with low breaking capacity close to the application Resistive: 3000 W Incandescent: 1800 W LV halogen: 1800 W Fluorescent: 400 VA Motors (roller blind type): 530 W 2 modules ○ White ● Magnesium
1	5 727 27	
1	5 723 63	<b>Emergency stop mushroom head push-buttons 10 A - 250 V~</b> N/O + N/C 2 modules <b>With key</b> Unlock with RONIS key no. 601 ● Yellow/red <b>1/4 turn</b> 1/4 turn unlocking ● Yellow/red
1	5 723 62	

# Arteor™

## double pole switches, cooker control unit



Support frame and plate selection charts **p. 386-389**

Mechanisms supplied with rocker plates, to be equipped with plates (p. 386 to 389). Support frame not needed

Pack	Cat.Nos	Double pole switches 40 A - 250 V~
5	5 720 81	Conform to EN 60669-1: 2000 and SANS 164-1 Captive terminal screws For flush-mounting box to be min. 48 mm deep Use US plate 4" x 4" - 2 modules <b>Double pole switch</b> ○ White ● Magnesium
5	5 725 81	
5	5 720 82	<b>Double pole switch + neon</b> ○ White ● Magnesium
5	5 725 82	
5	5 720 80	<b>Double pole switches 45 A - 250 V~</b> Conform to EN 60669-1: 2000 Captive terminal screws For flush-mounting box to be min. 48 mm deep <b>Double pole switch + neon - 2 gang</b> Use BS plate 3 modules ○ White ● Magnesium
5	5 725 80	
5	5 720 87	<b>Double pole switch + neon - 1 gang</b> Use BS plate 2 modules ○ White ● Magnesium
5	5 725 87	
5	5 720 88	<b>Cooker control unit 250 V~</b> Conform to BS 4177: 1992 45 A double pole switch + 13 A double pole switched socket outlet Use special plate (p. 386) ○ White

 Support frame and plate selection charts **p. 386-393**

Mechanisms supplied with rocker plates, to be equipped with support frames (p. 385) and plates (p. 386 to 393)

Pack	Cat.Nos	Fan controllers	Pack	Cat.Nos	Electric roller blind controllers - 250 V~
		2 modules			<b>For control via automatic box (N/O mechanism)</b>
1	5 722 17	<b>AC speed control - 4 positions</b>	10	5 722 19	Double push-button - 10 A
1	5 727 17	○ White ● Magnesium	10	5 727 19	2 modules
		<b>Rotary speed controller for fan</b>	10	5 732 19	○ White - square version
		Operates 40 to 400 VA limit switch	10	5 737 19	● Magnesium - square version
		For progressive speed control of ceiling fan			○ White - round version
1	5 722 18	○ White			● Magnesium - round version
1	5 727 18	● Magnesium			<b>For direct control of a motor (mechanism with fixed positions)</b>
		<b>Fan step regulator - 100 W</b>			Double push-button - 10 A
5	5 722 15	○ White	10	5 722 20	2 modules
5	5 727 15	● Magnesium	10	5 727 20	○ White - square version
		<b>Thermostats</b>	10	5 732 20	● Magnesium - square version
		<b>Electronic room thermostat</b>	10	5 737 20	○ White - round version
		Control knob with index and adjustable segments for min. and max. settings	10	5 737 20	● Magnesium - round version
		Adjustable range from 5 °C to 30 °C (+/- 0.5 °C)			<b>RCBO - 16 A - 230 V~</b>
		Power supply: 230 V~ - 50/60 Hz			Single pole + Neutral - 30 mA - 2 modules
		One potential free changeover contact output			The RCBO is used to protect people (premises with a conductive floor, presence of water, etc...) against direct contact with live parts or leakages to earth
		Suitable for controlling heated ceilings and underfloor heating	1	5 723 60	With test button
		- LV use breaking capacity:			○ White
		8 A - 250 V~ - resistive inductive circuit			
		2 A - 250 V~ - inductive circuit			
		- ELV use breaking capacity:			
		12 to 48 V~ - 12 to 24 V=, from 1 mA min. to 500 mA max.			
		2 modules			
1	5 722 03	○ White			
1	5 727 03	● Magnesium			
		<b>Thermostat for electric floor heating</b>			
		With one potential free N/O contact and LED			
		16 A - 230 V~			
		Adjustable range from 10 °C to 60 °C			
		2 modules			
1	5 722 63	○ White			
1	5 727 63	● Magnesium			
		<b>Curtain switches</b>			
		1 module			
5	5 722 02	<b>Curtain switch centre off</b>			
5	5 727 02	○ White			
		● Magnesium			
5	5 722 01	<b>Curtain switch centre retract</b>			
5	5 727 01	○ White			
		● Magnesium			
		<b>Thermal magnetic proximity MCB</b>			
		Single pole + Neutral - 230 V~ - 16 A			
		Used for local protection of part in a circuit (e.g. 2P+E socket) against overloads and short-circuits			
		Main protection being close to the user plus discriminating allows immediate reset			
		Can also be used as a local consumption limiter (depending on its rating)			
		Breaking capacity: 3000 A - 2 modules			
1	5 723 61	○ White			

# Arteor™

## British standard socket outlets



5 721 43

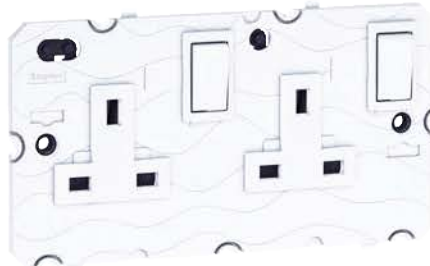

5 721 49



5 726 50

Support frame and plate selection charts **p. 386**

Mechanisms supplied with rocker plates, to be equipped with special plates (p. 386, 387)  
Support frame not needed

Pack	Cat.Nos	Single pole socket outlets 13 A - 250 V~
10	5 721 43	Shuttered for child safety ASTA licence Conform to BS 1363 Part 2 Use special plates (p. 386, 387) <b>2P+E switched - 1 gang</b> ○ White ● Magnesium
10	5 726 43	
10	5 721 44	<b>2P+E switched + neon - 1 gang</b> ○ White ● Magnesium
10	5 726 44	
5	5 721 45	<b>2P+E switched - 2 gang</b> ○ White ● Magnesium
5	5 726 45	
5	5 721 46	<b>2P+E switched + neon - 2 gang</b> ○ White ● Magnesium
5	5 726 46	
<b>Double pole socket outlets 13 A - 250 V~</b>		
5	5 721 47	Shuttered for child safety ASTA licence Conform to BS 1363 Part 2 Use special plates (p. 386, 387) <b>2P+E switched - 1 gang</b> ○ White ● Magnesium
5	5 726 47	
5	5 721 49	<b>2P+E switched - 2 gang</b> ○ White ● Magnesium ● Red for standard and clean earth applications Non standard pin configuration
5	5 726 49	
5	5 721 41	

Pack	Cat.Nos	Double pole socket outlets 5 A - 250 V~
10	5 721 40	Shuttered for child safety Conform to BS 546 Use special plates (p. 386, 387) <b>2P+E switched - 1 gang</b> ○ White ● Magnesium
10	5 726 40	
<b>Fused connection units</b>		
Double pole fused 13 A (fuse supplied) Flex outlet knockout and cord grip Captive fuse carrier (padlockable) Captive terminal screws Conform to BS 1363: part 4 Use special plates (p. 386, 387)		
5	5 721 50	<b>Switched</b> ○ White ● Magnesium
5	5 726 50	
5	5 721 51	<b>Switched + neon</b> ○ White ● Magnesium
5	5 726 51	
10	5 721 57	<b>Unswitched</b> ○ White ● Magnesium
10	5 726 57	



 Support frame and plate selection charts **p. 386-393**

Mechanisms supplied with rocker plates, to be equipped with support frames (p. 385) and plates (p. 386 to 393)

Pack	Cat.Nos	Multistandard socket outlets
10	5 721 23	<b>2P+E unswitched - shuttered for child safety - 2 modules</b> ○ White ● Magnesium
10	5 726 23	
5	5 721 35	<b>2P+E switched - shuttered for child safety - 3 modules</b> ○ White ● Magnesium
5	5 726 35	

Pack	Cat.Nos	British standard socket outlets
		Shuttered for child safety ASTA licence Conform to BS 1363 Part 2 Use special plates (p. 386, 387)
5	5 721 32	<b>2P+E switched - 15 A</b> Conform to BS 546 3 modules ○ White ● Magnesium
5	5 726 32	
10	5 721 11	<b>2P+E - 13 A</b> Conform to BS 1363 Part 2 ASTA licence 2 modules ○ White ● Magnesium
10	5 726 11	
5	5 721 30	<b>2P+E switched - 13 A</b> Conform to BS 1363 Part 2 ASTA licence 3 modules ○ White ● Magnesium ● Red dedicated non standard pin Use with plug Cat.No 6 745 32
5	5 726 30	
5	5 724 67	
10	5 721 10	<b>2P+E - 5 A</b> Conform to BS 546 2 modules ○ White ● Magnesium
10	5 726 10	

Pack	Cat.Nos	German standard socket outlets 16 A
		2 modules
10	5 721 18	<b>2P+E shuttered for child safety</b> ○ White ● Magnesium ● Red tamper-proof ● Dedicated green ● Dedicated orange
10	5 726 18	
10	5 724 63	
10	5 724 62	
10	5 724 60	
10	5 721 19	<b>2P+E with cover</b> ○ White ● Magnesium
10	5 726 19	

Pack	Cat.Nos	Euro-US type socket outlets - 15 A -127 V / 16 A - 250 V
10	5 721 04	<b>2P with shutters - 1 module</b> ○ White ● Magnesium
10	5 726 04	
10	5 721 16	<b>2P+E with shutters - 2 modules</b> ○ White ● Magnesium
10	5 726 16	
5	5 721 33	<b>2 x 2P+E with shutters - 3 modules</b> ○ White ● Magnesium
5	5 726 33	

Pack	Cat.Nos	American type socket outlets 15 A - 127 V
10	5 721 05	<b>2P - 1 module</b> ○ White ● Magnesium
10	5 726 05	
10	5 721 17	<b>2P+E - 2 modules</b> ○ White ● Magnesium
10	5 726 17	
5	5 721 34	<b>2 x 2P+E with shutters - 3 modules</b> ○ White ● Magnesium
5	5 726 34	

 Multistandard socket catalogue  
[www.docexport.legrand.com](http://www.docexport.legrand.com)

 Special cover plates for trunking,  
**p. 384**

# Arteor™

## international socket outlets (continued)



Support frame and plate selection charts p. 386-393

Mechanisms supplied with rocker plates, to be equipped with support frames (p. 385) and plates (p. 386 to 393)

Pack	Cat.Nos	South African type socket outlets - 16 A
10	5 721 22	<b>2P+E - shuttered for child safety - 2 modules</b> ○ White ● Magnesium ● Red
10	5 726 22	
10	5 724 61	
5	5 721 32	<b>2P+E switched - shuttered for child safety - 3 modules</b> ○ White ● Magnesium ● Red dedicated
5	5 726 32	
5	5 724 65	
1	5 720 22	<b>2 x 2P+E switched - pre-wired - 2 gang</b> Supplied with support frame Use 2 x 3 modules plate ○ White ● Magnesium
1	5 725 22	

Pack	Cat.Nos	ELV socket outlets 3 A
10	5 721 00	<b>2P</b> 12 mm fixing centres for plug Cat.No 0 500 05 1 module ○ White ● Magnesium
10	5 726 00	
20	0 500 05	<b>Plug</b> 2P - 3A for ELV socket outlet 12 mm fixing centres pins Ø3.6 mm

Pack	Cat.Nos	Italian type socket outlets
10	5 721 01	1 module <b>2P+E on line - 10 A</b> ○ White ● Magnesium
10	5 726 01	
10	5 721 03	<b>2P+E shuttered for child safety - 10/16 A</b> ○ White ● Magnesium
10	5 726 03	

Pack	Cat.Nos	Swiss type socket outlets
10	5 721 02	<b>2P+E type 12 shuttered for child safety - 10/16 A</b> 1 module ○ White
10	5 721 15	<b>2P+E type 13 shuttered for child safety - 10 A</b> 2 modules ○ White

Pack	Cat.Nos	Australian type socket outlets
10	5 721 14	2 modules <b>2P+E auto-switched shuttered for child safety - 10 A</b> ○ White ● Magnesium
10	5 726 14	
10	5 721 12	<b>2P+E shuttered for child safety - 10/15 A</b> ○ White ● Magnesium
10	5 726 12	
10	5 721 13	<b>Chinese type socket outlets</b> <b>2P+E shuttered for child safety - 10 A</b> 2 modules ○ White ● Magnesium
10	5 726 13	
10	5 721 21	<b>2P+E shuttered for child safety - 16 A</b> 2 modules ○ White ● Magnesium
10	5 726 21	
5	5 721 31	<b>2P+E Chinese + 2P Euro-US - 10 A</b> 3 modules ○ White ● Magnesium
5	5 726 31	

Pack	Cat.Nos	Israeli type socket outlets
10	5 721 24	<b>2P+E shuttered for child safety</b> ○ White ● Magnesium
10	5 726 24	

Pack	Cat.Nos	French standard socket outlets 10/16 A
10	5 720 20	2 modules <b>2P shuttered for child safety</b> ○ White ● Magnesium
10	5 725 20	
10	5 720 21	<b>2P+E shuttered for child safety</b> ○ White ● Magnesium
10	5 725 21	
10	5 724 66	<b>2P+E tamper-proof</b> Used to identify a mains circuit (e.g. inverter) and avoid connection of unnecessary equipment which may cause interference on the circuit ● Red

Pack	Cat.Nos	Tamperproof insert for Cat.No 5 724 66
10	0 502 99	Tamperproof insert for socket Fits directly into the plug

Supports for installation of Arteor socket outlets, p. 780



## Arteor™ USB chargers

square version



Support frame and plate selection charts **p. 386-393**

Mechanisms supplied with rocker plates, to be equipped with support frames (p. 385) and plates (p. 386 to 393)

Pack	Cat.Nos	USB power supplies
5 1	5 720 78 5 725 78	<p>For recharging portable devices Conform to IEC 62684-2011-01 Consumption in passive mode &lt; 0.1 W 2P+E tap-off connection via 2.5 mm<sup>2</sup> screw terminals Supplied without cord</p> <p><b>Double USB sockets - 5 V - 1500 mA</b> For fast charging telephones, smartphones, MP3/ MP4 players and tablet PC 2 modules</p> <ul style="list-style-type: none"> <li><input type="radio"/> White</li> <li><input checked="" type="radio"/> Magnesium</li> </ul>
10 10	5 720 71 5 725 71	<p><b>Single USB sockets - 5 V - 750 mA</b> For Smartphone 1 module</p> <ul style="list-style-type: none"> <li><input type="radio"/> White</li> <li><input checked="" type="radio"/> Magnesium</li> </ul>
1 1	5 720 73 5 725 73	<p><b>USB power supplies with retractable cord</b> For recharging portable devices such as telephones and smartphones Single socket 5 V - 1000 mA equipped with a retractable cord with micro USB connector Conform to IEC 62684-2011-01 Consumption in passive mode &lt; 0.2 W 2P+E tap-off connection via 2.5 mm<sup>2</sup> screw terminals Cord length: 30 cm 2 modules</p> <ul style="list-style-type: none"> <li><input type="radio"/> White</li> <li><input checked="" type="radio"/> Magnesium</li> </ul>
10	0 803 99	<p><b>Support for portable device on charge</b> Prevents device from any fall risk and allows secure use of device while charging Wall-mounting Fixing tools supplied</p> <p>For 1 portable device Supplied with retractable USB/micro USB version (60 cm/resistance &gt; 7500 manipulations) Can charge and make PC synchronisation</p>

## Arteor™ USB chargers

round version



Support frame and plate selection charts **p. 386-393**

Mechanisms supplied with rocker plates, to be equipped with support frames (p. 385) and plates (p. 386 to 393)

Pack	Cat.Nos	USB power supplies
10 1	5 724 88 5 733 98	<p>For recharging portable devices Conform to IEC 62684-2011-01 Consumption in passive mode &lt; 0.1 W 2P+E tap-off connection via 2.5 mm<sup>2</sup> screw terminals Supplied without cord</p> <p><b>Double USB sockets - 5 V - 1500 mA</b> For fast charging telephones, smartphones, MP3/ MP4 players and tablet PC 2 modules</p> <ul style="list-style-type: none"> <li><input type="radio"/> White</li> <li><input checked="" type="radio"/> Magnesium</li> </ul>
1 1	5 724 83 5 733 93	<p><b>USB power supplies with retractable cord</b> For recharging portable devices such as telephones and smartphones Single socket 5 V - 1000 mA equipped with a retractable cord with micro USB connector Conform to IEC 62684-2011-01 Consumption in passive mode &lt; 0.2 W 2P+E tap-off connection via 2.5 mm<sup>2</sup> screw terminals Cord length: 30 cm 2 modules</p> <ul style="list-style-type: none"> <li><input type="radio"/> White</li> <li><input checked="" type="radio"/> Magnesium</li> </ul>
10	0 803 99	<p><b>Support for portable device on charge</b> Prevents device from any fall risk and allows secure use of device while charging Wall-mounting Fixing tools supplied</p> <p>For 1 portable device Supplied with retractable USB/micro USB version (60 cm/resistance &gt; 7500 manipulations) Can charge and make PC synchronisation</p>

Video of USB chargers



# Arteor™ USB chargers

## Relevant, economic and environmental decision

Finished outlets occupied by bulky and unsightly mobile chargers or chargers forgotten office or hotel... Installed in a few key places, universal chargers USB ports provide a daily service and significant availability. With a simple USB cable, you can immediately access the charging of the mobile device... The desk, next to the kitchen worktop or in headboard.

Thanks to its dual USB connectors, two devices can be charged simultaneously and quickly: smartphone, tablet, joystick or mobile GPS... a valuable service to peak hours of family, significant from 1 h load due to self its mechanism in 1500 mA exclusive and very powerful.

Easy to install, the USB port is powered by transplanting a single socket (P/N) or in place of existing outlet. Users will spot easily charging points installed in different areas with an explicit symbol.

Very economical in its design and with a standby consumption < 0.1 W, 5 times lower than the normative requirement of reference, it can reduce its energy consumption every day and contribute to protect planet.

## Installation

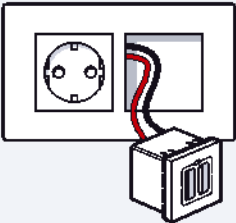

By simple tap-off on 2P+E socket  
Wiring 1.5 or 2.5 mm<sup>2</sup>  
Class II product which does not require earthing  
Releases a 2P+E socket recess

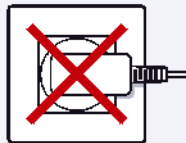

## Average charge time for a smartphone with a 1500 mA charger

Brand	Smartphone	Average charge time 80 %	Average charge time 100 %
RIM	Blackberry Torch 9810	01h01	01h23
Apple	iPhone 3GS	01h04	02h07
Apple	iPhone 4S	01h14	01h56
Apple	iPhone 5	01h14	02h20
Motorola	Defy - MB525 - Jordan	01h13	01h47
Nokia	Lumia 800 - Sea Ray	01h39	02h33
Samsung	Galaxy S III - 19300	01h47	02h43
Samsung	Galaxy S IV	02h00	02h59
Sony	XPERIA S - LT26i - Arc HD Nozomi	01h20	02h05
		average < 1h15	average < 2h

## Universal duo USB charging socket

Can quickly charge all mobiles in the family

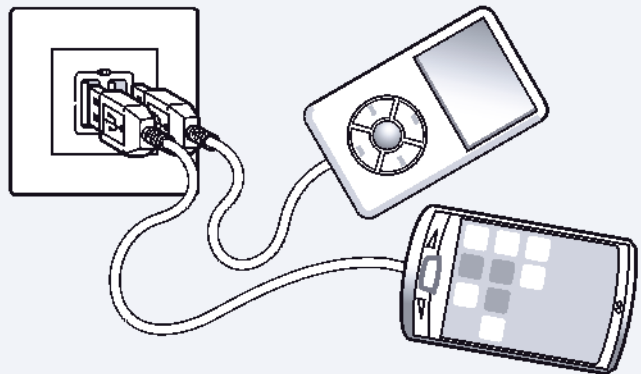

## Universal proximity socket

Ideal for everyday needs

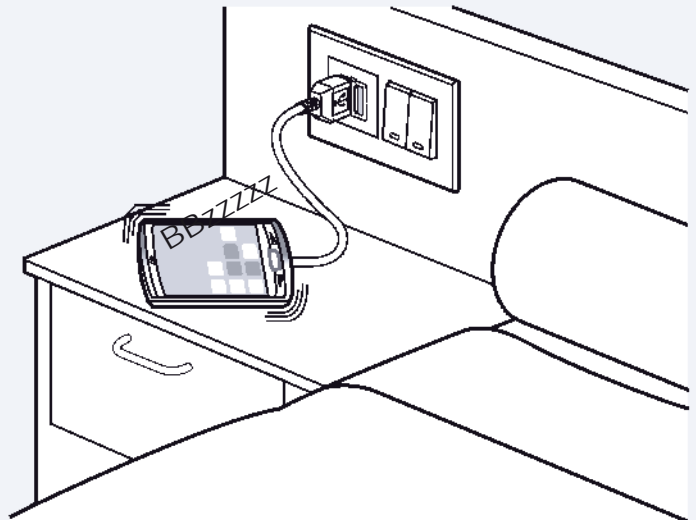

## The Micro USB version with retractable cord

Always have the cord available

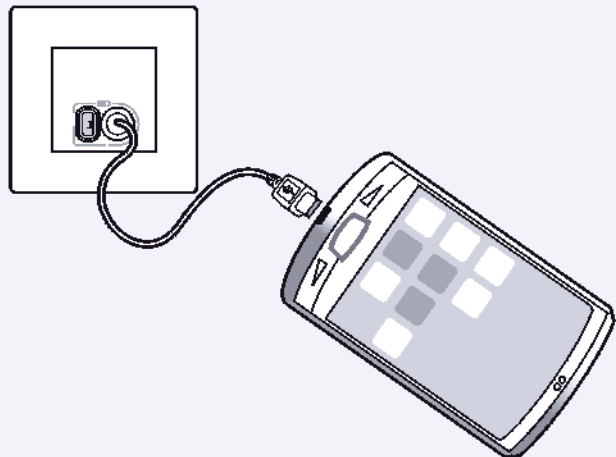

 Support frame and plate selection charts **p. 386-393**

Mechanisms supplied with rocker plates, to be equipped with support frames (p. 385) and plates (p. 386 to 393)

Pack	Cat.Nos	RJ 11 and RJ 12 sockets	Pack	Cat.Nos	Television sockets
10	5 723 00	Equipped with modular Jack connector with 1/4 turn terminal for fast connection (possible looping) <b>RJ 11 - 1 module</b> 4 contacts ○ White ● Magnesium			For Hertzian and satellite installation (with individual demodulator) DTT and HDTV compatible Shielded star socket TV: male connector (Ø9.5 mm), attenuation - 1.5 dB R: female connector (Ø9.5 mm), attenuation - 1.5 dB SAT: "F" type connector, attenuation - 1.5 dB Recommended coaxial cable: 17/19 VATC
10	5 728 00				
10	5 723 13	<b>RJ 11 - 2 modules</b> 4 contacts ○ White ● Magnesium			<b>TV-R-SAT sockets</b> TV: 5-68 /120-862 MHz R: 87.5-108 MHz SAT: 950-2400 MHz 2 modules
10	5 728 13				
10	5 723 12	<b>RJ 12 - 2 modules</b> 6 contacts ○ White ● Magnesium	10	5 721 72	○ White ● Magnesium
10	5 728 12			10	
		<b>Telephone sockets</b> With IDC connection Conform to British Telecom			
10	5 723 10	<b>Single master - 2 modules</b> ○ White ● Magnesium	10	5 721 70	○ White ● Magnesium
10	5 728 10			10	
5	5 723 01	<b>Single secondary - 1 module</b> ○ White ● Magnesium	10	5 721 71	<b>TV sockets</b> TV: 0-2400 MHz 1 module ○ White ● Magnesium
5	5 728 01			10	
			10	5 721 63	<b>TV sockets "F" type with screws</b> SAT: 0-2400 MHz 1 module ○ White ● Magnesium
			10	5 726 63	





# Arteor™

## RJ 45 sockets

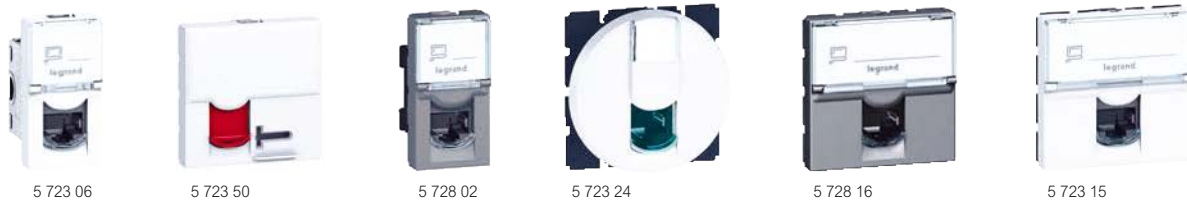

Support frame and plate selection charts **p. 386-393**

With LCS<sup>2</sup> connector with fast connection thanks to integrated crimping  
 Take AWG 22 single-core cables up to AWG 26 and AWG multicore cables  
 Contacts marked with dual colour code and wiring schemes T568 A and T 568 B  
 Conform to standards ISO/IEC 11801 Ed. 2.0, amendment 2, EN 50173-1 and TIA/EIA 568 C  
 Mechanisms supplied with rocker plates, to be equipped with support frames (p. 385) and plates (p. 386 to 393)

Pack	Cat.Nos	Cat. 6 <sub>A</sub> sockets
		360° metal shielding
		<b>STP - 1 module</b>
10	5 723 06	White
10	5 728 06	Magnesium
10	5 723 51	White with orange shutter
10	5 728 51	Magnesium with orange shutter
10	5 723 52	White with green shutter
10	5 728 52	Magnesium with green shutter
		<b>STP with controlled access - 2 modules</b> Supplied with 2 keys for 5 sockets
5	5 723 50	White with red shutter
5	5 728 50	Magnesium with red shutter
		<b>UTP - 1 module</b>
10	5 723 49	White
10	5 728 49	Magnesium
10	5 723 59	White with green shutter
10	5 728 59	Magnesium with green shutter
10	5 723 58	White with orange shutter
10	5 728 58	Magnesium with orange shutter
		<b>UTP with controlled access - 2 modules</b> Supplied with 2 keys for 5 sockets
5	5 723 57	White with red shutter
5	5 728 57	Magnesium with red shutter

Pack	Cat.Nos	Cat. 6 sockets
		<b>UTP - 1 module</b>
10	5 723 02	White
10	5 728 02	Magnesium
10	5 723 54	White with orange shutter
10	5 728 54	Magnesium with orange shutter
10	5 723 55	White with green shutter
10	5 728 55	Magnesium with green shutter
		<b>UTP - 2 modules</b>
10	5 723 14	White - square version
10	5 728 14	Magnesium - square version
10	5 723 24	White - round version
10	5 728 24	Magnesium - round version

Pack	Cat.Nos	Cat. 6 sockets (continued)
		<b>UTP with controlled access - 2 modules</b> Supplied with 2 keys for 5 sockets
5	5 723 53	White with red shutter
5	5 728 53	Magnesium with red shutter
		<b>UTP with retractable cord - 4 modules</b> Cord (0.9 m) winds up automatically with a pushbutton
1	5 723 39	White
1	5 728 39	Magnesium
		<b>FTP - 1 module</b>
10	5 723 22	White
10	5 728 22	Magnesium
		<b>FTP - 2 modules</b>
10	5 723 16	White
10	5 728 16	Magnesium
		<b>STP shielded - 1 module</b>
10	5 723 23	White
10	5 728 23	Magnesium
		<b>STP shielded - 2 modules</b>
10	5 723 17	White
10	5 728 17	Magnesium

Pack	Cat.Nos	Cat. 5e sockets
		<b>UTP - 1 module</b>
10	5 723 03	White
10	5 728 03	Magnesium
		<b>UTP - 2 modules</b>
10	5 723 15	White
10	5 728 15	Magnesium
		<b>FTP - 1 module</b>
10	5 723 04	White
10	5 728 04	Magnesium



5 723 31



5 728 32



5 723 36



5 728 35

 Support frame and plate selection charts **p. 386-393**

Mechanisms supplied with rocker plates, to be equipped with support frames (p. 385) and plates (p. 386 to 393)

Pack	Cat.Nos	Rear pluggable RJ 45 sockets	Pack	Cat.Nos	Telephone/Ethernet wiring splitters
		Certified as conforming to standards ISO 11801 ed. 2.0, EN 50173-1 and EIA/TIA 568 Contacts marked with 568 A and B dual colour code and numbers Connectors with self-stripping terminals Possibility of re-wiring in the event of error Multidirectionnal cable entry For use with area distribution boxes (p. 676), connection to boxes via RJ45-RJ45 dedicated cords (p. 676) Used to create Cat. 6 and Cat. 5e links in accordance with standards 2 modules			Provide increased security against theft and damage to double connectors Provide a rate of 10/100 Mbps Multidirectionnal cable entry Can be installed in all supports depth min. 35 mm Telephone and Ethernet applications marked on the protective cap 1 module
10	5 723 31	<b>Cat. 6 - UTP</b> ○ White ● Magnesium	10	5 723 36	<b>FTP - double connector</b> 9 contacts ○ White ● Magnesium
10	5 728 31		10	5 728 36	
10	5 723 33	<b>Cat. 6 - FTP</b> ○ White ● Magnesium	10	5 723 35	<b>UTP - double connector</b> 8 contacts ○ White ● Magnesium
10	5 728 33		10	5 728 35	
10	5 723 30	<b>Cat. 5e - UTP</b> ○ White ● Magnesium	10	5 723 32	
10	5 728 30		10	5 728 32	
10	5 723 32	<b>Cat. 5e - FTP</b> ○ White ● Magnesium	10	5 723 35	
10	5 728 32		10	5 728 35	

# Arteor™

## Wi-Fi access points



5 723 76

Support frame and plate selection charts p. 386-393

Mechanisms supplied with rocker plates, to be equipped with support frames (p. 385) and plates (p. 386 to 393)

Pack	Cat.Nos	Wi-Fi access points
		<p>Dual-band and dual-radio.                      Conform with standards 802.11a and 802.11b/g                      Gross speed: 54 Mbps max. on each frequency (802.11a and 802.11g) simultaneously                      Can be installed in addition to a new or existing LCS/LCS<sup>2</sup> structured wiring system to meet mobile working requirements                      Can be integrated into all compatible supports with minimum 40 mm depth                      Tool-free network connection via RJ 45 connector                      PoE power supply (Power over Ethernet - standard 802.3 af)                      The installation must include at least:                      - Wi-Fi access point                      - a PoE injector (p. 682) conforming with 802.3 af (LCS<sup>2</sup> unit format) to be installed in the patch panel                      The management function allows the network administrator to manage Wi-Fi access points remotely via a web interface                      Security via WPA2 encryption (802.11i) and 802.1x authentication                      Guest access: allows visitors free access to the Internet (access independent of the main Wi-Fi network)                      4 modules</p>
		<b>With RJ 45 socket on the front panel</b>
1	5 723 76	○ White
1	5 728 76	● Magnesium
		<b>Without RJ 45 socket</b>
1	5 723 77	○ White
1	5 728 77	● Magnesium

# Arteor™

## Wi-Fi access points

### Installation principle

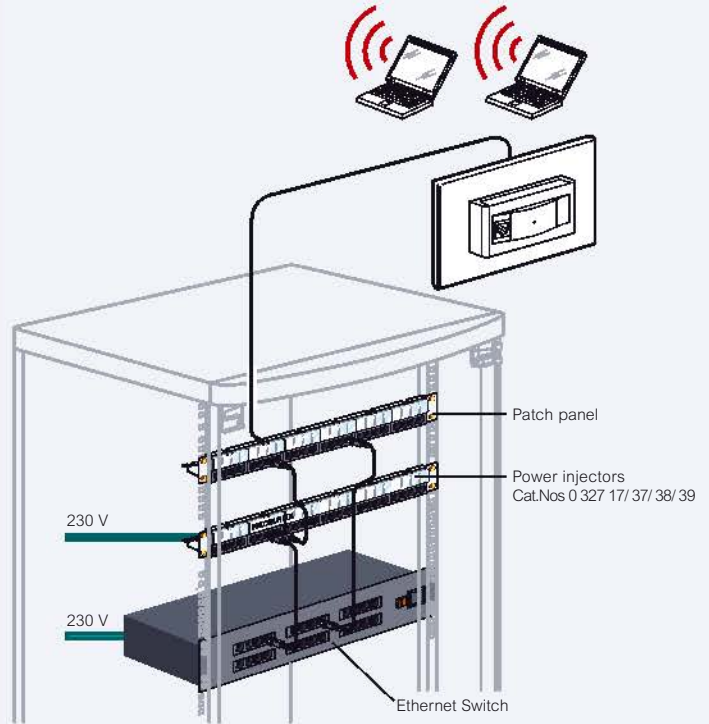

### Wi-Fi access points

#### A 802.11 a and b/g solution

Radio communication standard	802.11 b/g	802.11 a
Power over Ethernet standard	802.3 af	
Frequency band	between 2.40 and 2.48 GHz	5 GHz
Number of available channels	13	8
Max. data rate	54 Mbps	54 Mbps

### Advantages of a Legrand Wi-Fi access point

- Possibility of simultaneous operation on 2 frequencies, a and b/g
- Provides a max. data rate of up to 2 x 54 Mbps in simultaneous mode
- Very high security level: encryption (WPA2 - 802.11i) and authentication (802.1x)
- Possibility of roaming (moving from one access point to another without breaking the link)
- Quality of service (priority automatically given to voice, then video and finally data) in accordance with standard 802.11e
- Easy to configure and make secure with the quick configuration node

**NEW:** Guest access to offer a free access for the guest and keep independent and secure the main Wi-Fi network

### Installation

In all supports that can take an Arteor mechanism (ducting, columns, flush-mounting boxes, floor boxes, etc)  
 Do not place access points behind an obstacle that would limit the radiation of the antenna  
 Access points are connected in the same way as RJ 45 sockets

### Sizing

- Provide 1 access point for 1 localised requirement
- Provide 1 access point per 100 m<sup>2</sup> for global coverage and a maximum gross speed
- Provide 1 access point with an RJ 45 socket for an office used by visitors

### Legrand services

To guide you in setting up your VDI sites:

- Help with sizing the installation
- On site assistance for integrating products and making important installations secure



Support frame and plate selection charts **p. 386-393**

Mechanisms supplied with rocker plates, to be equipped with support frames (p. 385) and plates (p. 386 to 393)

Pack	Cat.Nos	Adaptors for Ortronics data sockets
10	5 728 18	Equipped with transparent label-holder <b>Single Clarity Rear load connector - 1 module</b> Straight plug ● Magnesium
10	5 723 37	<b>Adaptors for Keystone data sockets</b> Equipped with transparent label-holder <b>Single connector - 2 modules</b> ○ White ● Magnesium
10	5 728 37	
10	5 723 38	<b>Adaptors for Systimax data sockets</b> Equipped with transparent label-holder <b>Single connector - 2 modules</b> ○ White ● Magnesium
10	5 728 38	

Pack	Cat.Nos	Female USB data sockets
		Used to bring connections closer to the user For connecting USB devices (scanner-printer, external hard disk) Maximum length: 5 m Recommended cable: USB A <b>Preterminated - USB 3.0 - 1 module</b> Equipped with a 15 cm cord
1	5 720 94	○ White - square version ● Magnesium - square version
1	5 725 94	
1	5 724 74	<b>Preterminated - USB 3.0 - 2 modules</b> Equipped with a 15 cm cord ○ White - round version ● Magnesium - round version
1	5 733 74	
1	5 722 75	<b>Connection via screw terminals - USB 2.0 1 module</b> Cross-section 1 mm <sup>2</sup> ○ White - square version ● Magnesium - square version
1	5 727 75	
1	5 732 74	<b>Connection via screw terminals - USB 2.0 2 modules</b> Cross-section 1 mm <sup>2</sup> ○ White - round version ● Magnesium - round version
1	5 737 74	
1	5 720 23	<b>Female USB DATA amplifier - for data transfer</b> Used to bring connections closer to the user in case of large distances For connecting USB devices (digital school board / interactive whiteboard...) located more than 5 m away from a source (computer...) The kit includes a transmitter (1 module) and a receiver (1 module) The link between the transmitter and the receiver is made via a RJ 45/RJ 45 cord ○ White - square version



# Arteor™

## attenuators and loudspeaker sockets



5 722 84



5 722 83



5 722 70



Support frame and plate selection charts **p. 386-393**

Mechanisms supplied with rocker plates, to be equipped with support frames (p. 385) and plates (p. 386 to 393)

Pack	Cat.Nos	Attenuators
1	5 722 84	100 V - 25 W Allow to adjust power to 25 W from a balanced 100 V loudspeaker line 2 modules ○ White ● Magnesium
1	5 727 84	
<b>3-pole XLR sockets</b> For the stereo connection of any peripheral, microphone, mixing console Recommended cable: 1 audio pair 0.14 to 0.5 mm <sup>2</sup> shielded Max. cable length: 50 m (beyond this an audio amplifier is recommended) 2 modules		
1	5 722 83	<b>XLR female</b> ○ White ● Magnesium
1	5 727 83	
1	5 722 77	<b>XLR male</b> ○ White ● Magnesium
1	5 727 77	
<b>Loudspeaker sockets</b> 4 mm <sup>2</sup> terminals		
10	5 722 70	<b>1 module</b> ○ White ● Magnesium
10	5 727 70	
10	5 722 80	<b>2 modules</b> ○ White ● Magnesium
10	5 727 80	

## LEGRAND PACKAGING

# Practical and, eco-friendly

Legrand packaging – your assistance of a certified original product which is factory inspected, protected and clearly identifiable

Dustproof flaps:  
effective  
protection  
of the product

Resealable box:  
for easy  
management  
of the contents

Informative label:  
- Catalogue number/  
quantity  
- Picture of the product  
- Clear description  
- Technical information  
- Barcode  
- Regulatory marking



The red and white  
box and the logo  
are registered  
trademarks

Eco-friendly:  
- Recyclable cardboard  
packaging  
- Printing inks comply with  
environmental standards



# The right system to meet your needs

A wide range of technologies (HD15, HDMI, DISPLAY PORT, RCA, JACK) to suit the location and the user requirements

## INSTALLATION EXAMPLE WITH HD15 PRETERMINATED SOCKET AND VIDEO PROJECTOR SWITCH

**1** Quick  
Installation

**2** Easy  
connection

**3** Optimum  
performance



**1** Infrared ON/STANDBY control  
for video projector associated  
with a push-button  
Cat.No 5 720 89

**2 3** Preterminated HD15 sockets  
Cat.No 5 720 97

**4** 10 m male/male HD15 cords  
Cat.No 0 517 23

**5 6** Male/male HD 15 cords

# Arteor™

## audio and video sockets



Support frame and plate selection charts p. 386-393

Mechanisms supplied with rocker plates, to be equipped with support frames (p. 385) and plates (p. 386 to 393)

Pack	Cat.Nos			Pack	Cat.Nos	
			<b>Female HD15 sockets</b>			<b>Jack sockets 3.5 mm</b>
			Used to transmit analog video streams (VGA, XGA, UXGA depending on graphic card) between a source (computer) and a compatible receiver (plasma, LCD, video projector, TV, etc...)			3.5 mm jack connectors can be used to create audio/video links
			<b>Preterminated sockets - 1 module</b> Equipped with cord, length 15 cm			<b>Preterminated sockets - 1 module</b> Equipped with cord, length 15 cm
1	Square version 5 720 97	Round version -	○ White ● Magnesium	1	Square version 5 720 91	○ White ● Magnesium
1	5 725 97	-		1	5 725 91	
			<b>Preterminated HD15 + 3.5 mm jack sockets - 2 modules</b> Equipped with cord, length 15 cm			<b>4 screw-type female 3.5 mm jack socket 1 module</b>
1	-	5 724 78	○ White ● Magnesium	1	5 722 74	○ White ● Magnesium
1	-	5 733 78		1	5 727 74	
			<b>Screw-type female HD15 sockets 2 modules</b>			<b>Solder-type female 3.5 mm jack socket 1 module</b>
1	5 722 82	5 722 89	○ White ● Magnesium	1	5 722 78	○ White ● Magnesium
1	5 727 82	5 727 89		1	5 727 78	
			<b>Screw-type female HD15 + 3.5 mm jack sockets - 2 modules</b>			<b>HD15 + 3.5 mm Jack amplifier</b>
1	5 722 88	-	○ White ● Magnesium			Used to connect audio/video terminals more than 20 m apart up to 100 m
1	5 727 88	-				The video link is via an HD15 connector (resolution up to UXGA)
			<b>Solder-type female HD15 sockets 1 module</b> 15 pin			The stereo audio link is via a 3.5 mm jack
1	5 722 79	-	○ White ● Magnesium			The kit includes:
1	5 727 79	-				- One 4-module transmitter equipped with an HD15 connector and a 3.5 mm jack
			<b>HDMI type A sockets</b>			- One 4-module receiver equipped with an HD15 connector and a 3.5 mm jack
			Used to transmit high-definition digital audio/video streams between a source (HD-DVD drive, computer, etc) and a compatible receiver (TV, videoprojector...)			- One 4-module power supply to be connected on the mains then linked to the receiver or transmitter
			<b>Preterminated sockets HDMI 1.4 - 1 module</b> Equipped with cord, length 15 cm			The link between the transmitter and receiver is via a network cord RJ 45/RJ 45
1	Square version 5 720 96	Round version -	○ White ● Magnesium	1	Square version 5 723 70	○ White
1	5 725 96	-				
			<b>Preterminated sockets HDMI 1.4 - 2 modules</b> Equipped with cord, length 15 cm			
1	-	5 724 76	○ White ● Magnesium			
1	-	5 735 96				
			<b>Screw-type sockets HDMI 1.3 - 2 modules</b>			
1	5 722 81	5 722 85	○ White ● Magnesium			
1	5 727 81	5 727 85				

Patch panels, cables and cords, p. 696





5 720 89



5 720 90



5 722 72



5 720 93



5 722 76

Support frame and plate selection charts p. 386-393

Mechanisms supplied with rocker plates, to be equipped with support frames (p. 385) and plates (p. 386 to 393)

Pack	Cat.Nos	Videoprojector switch
1	Square version 5 720 89 	<p>Universal remote switch allowing to turn ON or place in STANDBY mode a video projector</p> <p>Works with all videoprojectors or TV through IR learning process</p> <p>Installed close to the room's lighting switches, it replaces the constructors remote and fosters the ignition and extinction of the video projector therefore reducing energy consumption and extending the bulb's lifetime</p> <p> ○ White</p>

Pack	Cat.Nos	Display port sockets
1	Square version 5 720 90	<p>Used to transmit high-definition digital audio/video streams between a source (laptop, computer, etc) and a compatible receiver (TV, videoprojector...)</p> <p><b>Preterminated socket - 1 module</b> Equipped with cord, length 15 cm</p> <p> ○ White ● Magnesium</p>
1	5 725 90	
1	Round version 5 724 70	<p><b>Preterminated socket - 2 modules</b> Equipped with cord, length 15 cm</p> <p> ○ White ● Magnesium</p>
1	5 735 90	

Pack	Cat.Nos	Female 2 RCA sockets
1	Square version 5 720 92	<p>Provide the stereo audio link for any peripheral device such as a DVD drive, camera, video recorder</p> <p><b>Preterminated - 1 module</b> Equipped with a 15 cm cord</p> <p> ○ White ● Magnesium</p>
1	5 725 92	
1	-	<p><b>Preterminated - 2 modules</b> Equipped with a 15 cm cord</p> <p> ○ White ● Magnesium</p>
1	5 724 72 5 735 92	
1	5 722 72	<p><b>Connection on screw terminals - 1 module</b></p> <p> ○ White ● Magnesium</p>
1	5 727 72	
1	-	<p><b>Connection on screw terminals - 2 modules</b></p> <p> ○ White ● Magnesium</p>
1	5 732 72 5 737 72	

Pack	Cat.Nos	Female 3 RCA sockets
1	Square version 5 720 93	<p>Provide the composite video and stereo audio link for any peripheral device such as a DVD drive, camera, video recorder, videoconferencing, etc</p> <p><b>Preterminated - 1 module</b>  ○ White ● Magnesium</p>
1	5 725 93	
1	-	<p><b>Preterminated - 2 modules</b>  ○ White ● Magnesium</p>
1	5 724 73 5 735 93	
1	5 722 73	<p><b>Connection on screw terminals - 1 module</b></p> <p> ○ White ● Magnesium</p>
1	5 727 73	
1	-	<p><b>Connection on screw terminals - 2 modules</b></p> <p> ○ White ● Magnesium</p>
1	5 732 73 5 737 73	

Pack	Cat.Nos	Female BNC 75 sockets
1	Square version 5 722 76	<p>Provide the composite video link for any peripheral device such as a DVD drive, camera, video recorder, etc</p> <p><b>Connection on screw terminals - 1 module</b>  ○ White ● Magnesium</p>
1	5 727 76	



# Arteor™

## ancillary mechanisms



# Arteor™

## blinking cover plates



Support frame and plate selection charts **p. 386-393**

Mechanisms supplied with rocker plates, to be equipped with support frames (p. 385) and plates (p. 386 to 393)

Support frame and plate selection charts **p. 386-393**

To be equipped with support frames and plates

Pack	Cat.Nos	Blank modules
10	5 723 41	<b>1 module</b> ○ White - square version ● Magnesium - square version
10	5 728 41	
10	5 723 42	<b>2 modules</b> ○ White - square version ● Magnesium - square version
10	5 728 42	
10	5 730 86	○ White - round version ● Magnesium - round version
10	5 731 86	
5	5 723 43	<b>3 modules</b> ○ White - square version ● Magnesium - square version
5	5 728 43	
5	5 730 96	○ White - round version ● Magnesium - round version
5	5 731 96	
10	5 723 20	<b>Cable outlets</b> <b>20 A cable outlet for junction - 2 modules</b> ○ White
5	5 723 21	<b>45 A cable outlet - BS 1 gang</b> Supplied with cover plate For flush mounting back box to be min. 45 mm deep ○ White
10	5 723 07	<b>Cord outlets</b> <b>1 module with Ø8 mm entry</b> ○ White
10	5 723 19	<b>2 modules</b> ○ White

Pack	Cat.Nos	British standard blanking cover plates
5	5 751 30	<b>For 1 gang box</b> ○ White ● Pearl Alu ● Graphite
5	5 751 31	
5	5 751 32	
5	5 751 40	<b>For 2 gang box</b> ○ White ● Pearl Alu ● Graphite
5	5 751 41	
5	5 751 42	
10	5 754 10	<b>Italian/US standard blanking cover plates</b> <b>For 2" x 4" boxes</b> ○ White ● Pearl Alu ● Graphite
10	5 754 11	
10	5 754 12	
5	5 753 60	<b>US standard blanking cover plates</b> <b>For 4" x 4" boxes</b> ○ White ● Pearl Alu ● Graphite
5	5 753 61	
5	5 753 62	



5 760 16



5 754 50



5 754 70

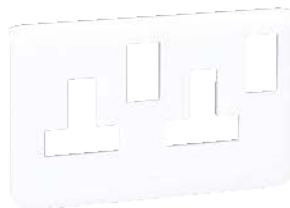

5 754 80



5 751 90



5 723 90



5 723 92



 Support frame and plate selection charts **p. 386-393**

Pack	Cat.Nos	Panel mounting supports
10	5 760 15	For 1 to 3 mm thick panels For 1 module Clips into a 28 x 53.5 mm aperture
10	5 760 16	For 2 modules Clips into a 58 x 53.5 mm aperture
10	5 760 13	<b>Modular support</b> For mounting 2-module mechanisms on symmetrical rail
10	5 754 50	<b>Dedicated plates for trunking</b> 1-gang plate 2 modules (supplied with support frame)
5	5 754 60	2-gang plate 2 x 2 modules (supplied with support frame)
10	5 754 70	White plate for 1-gang 13 A switched socket
5	5 754 80	White plate for 2-gang 13 A switched socket
5	5 751 90	<b>IP 44 plate</b> For British and German standards For mounting in 1-gang box Support frame supplied

Pack	Cat.Nos	Flush-mounting boxes
1	6 890 36	For British standard 6 and 8-module plates and frames For 6 modules 211.4 x 75.7 x 50.8 mm
1	6 890 38	For 8 modules 231 x 75.7 x 50.8 mm
1	6 890 28	For 2 x 6 modules 212 x 143 x 42 mm
1	0 818 56	For 3 x 6 modules 212 x 212 x 42 mm
10	5 723 90	<b>Surface-mounting boxes</b> For British, German and French standard For 2 modules - 1 gang 38 mm depth
5	5 723 92	For 4 modules 2 x 2 modules - 2 gang 48 mm depth (suitable for shaver sockets)
2	5 723 96	For 2 x 6 modules 38 mm depth

# Arteor™

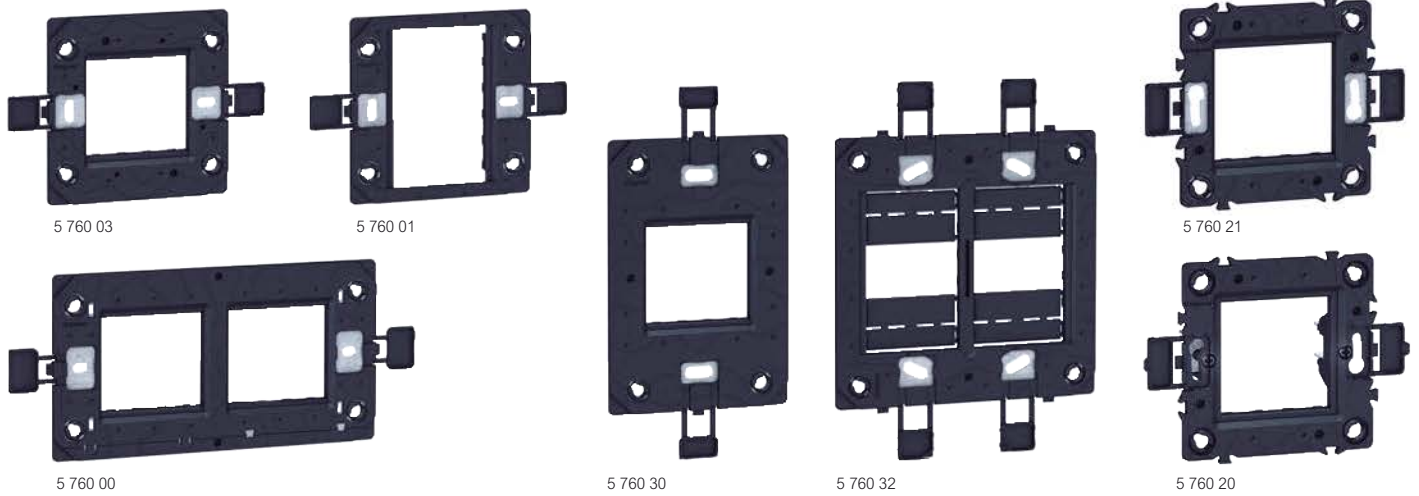
## international support frames



Support frame and plate selection charts **p. 386-393**

Pack	Cat.Nos	Support frames for BS type boxes 60.3 mm fixing centres
10	5 760 03	Screw mounting (screws supplied) <b>For 1 gang box</b> Square - for 1 or 2 modules 
5	5 760 01	Square - for 3 modules 
10	5 760 02	<b>For 2 gang box</b> Rectangular - for 3 modules 
10	5 760 00	Rectangular - for 2 x 2 modules 

Pack	Cat.Nos	Support frames for US and South African type boxes 83.5 mm fixing centres
10	5 760 30	Screw mounting <b>For 2" x 4" boxes</b> For 2 modules (electronic functions except 2-module mechanisms to be mounted on 3-module support frame) 
10	5 760 40	For 1 to 3 modules 
5	5 760 31	<b>For 4" x 4" boxes</b> For 2, 3 and 4 modules 
5	5 760 32	For 2 x 3 modules 

Pack	Cat.Nos	Support frames for German and French type boxes
10	5 760 21	Screw mounting For 1 or 2 modules 
5	5 760 11	For 4 modules 
5	5 760 12	For 6 modules Horizontal mounting 
2	5 760 22	For 2 x 6 modules Horizontal mounting 
5	5 760 20	Claw mounting For 1 or 2 modules 

Pack	Cat.Nos	Support frame for Italian type boxes 83.5 mm fixing centres
10	5 760 40	Screw mounting For 1 to 3 modules 

# Arteor™ British standard plate selection charts

60.3 mm fixing centres - flush-mounting boxes, support frames and plates

Number of modules per mechanism	Flush-mounting boxes	Support frames	Plates	PLATES					
				Neutral			Tattoo	Graphic	
				White	Pearl Alu	Graphite	Edition 1	Casual	Formal
<b>SQUARE VERSION</b>									
<b>1 module</b>	1 gang	5 760 03		5 752 00	5 752 01	5 752 02	5 761 08	5 761 01	5 761 02
<b>2 modules and 1.2" touch screen</b>		5 760 03 5 760 01 <sup>(1)</sup>		5 752 10	5 752 11	5 752 12	5 761 28	5 761 21	5 761 22
<b>3 modules - 1 gang</b>	1 gang	5 760 01		5 751 60	5 751 61	5 751 62	5 761 88	5 761 81	5 761 82
<b>3 modules and shaver sockets</b>	2 gang	5 760 02		5 750 70	5 750 71	5 750 72	5 761 68	5 761 61	5 761 62
<b>4 modules</b>	2 gang	5 760 00		5 750 80	5 750 81	5 750 82	5 761 48	5 761 41	5 761 42
<b>6 modules</b>	6 890 36	Supplied with support frame		5 753 70	5 753 71	5 753 72	5 763 78	5 763 71	5 763 72
<b>8 modules</b>	6 890 38	Supplied with support frame		5 767 00	5 767 01	5 767 02	5 767 18	5 767 11	5 767 12
<b>2 x 6 modules</b>	6 890 28	Supplied with support frame		5 753 90	5 753 91	5 753 92	-	-	-
<b>3 x 6 modules</b>	0 818 56	Supplied with support frame		5 754 00	5 754 01	5 754 02	-	-	-
<b>For 5 A/13 A switched socket outlet - 1 gang</b>	-	Not needed		5 750 90	5 750 91	5 750 92	5 762 18	5 762 11	5 762 12
<b>For 13 A twin Switched socket outlet - 2 gang</b>	-	Not needed		5 751 00	5 751 01	5 751 02	5 762 08	5 762 01	5 762 02
<b>For 13 A fused connection unit switched</b>	-	Not needed		5 751 20	5 751 21	5 751 22	5 761 98	5 761 91	5 761 92
<b>For cooker unit Cat.No 5 720 88</b>	-	Not needed		5 751 50	-	-	-	-	-
<b>Blanking cover plate British standard</b>	1 gang	5 760 03 5 760 01		5 751 30	5 751 31	5 751 32	-	-	-
<b>Blanking cover plate British standard</b>	2 gang	5 760 02		5 751 40	5 751 41	5 751 42	-	-	-
<b>ROUND VERSION</b>									
<b>2 modules</b>	1 gang	5 760 03		5 756 10	5 756 11	5 756 12	5 761 18	5 761 11	5 761 12
<b>3 modules</b>	2 gang	5 760 02		5 755 40	5 755 41	5 755 42	5 761 58	5 761 51	5 761 52
<b>3 modules - 1 gang</b>	1 gang	5 760 01		5 755 60	5 755 61	5 755 62	5 761 78	5 761 71	5 761 72
<b>4 modules</b>	2 gang	5 760 00		5 755 50	5 755 51	5 755 52	5 761 38	5 761 31	5 761 32
<b>6 modules</b>	6 890 36	Supplied with support		5 767 40	5 767 41	5 767 42	5 767 58	5 767 51	5 767 52
<b>8 modules</b>	6 890 38	Supplied with support		5 766 80	5 766 81	5 766 82	5 766 98	5 766 91	5 766 92

1: Use 5 760 01 support frame for 2 module mechanisms to be mounted on 3 module support frame (see mention in catalogue page)











PLATES

PLATES										
Mirror				Brushed metal		Wood		Leather		Signature
Mirror White	Mirror Black	Mirror Red	Mirror Taupe	Stainless Steel	Gold Brass	Wenge Style	Light Oak	Club	Galuchat	Woven Metal
5 752 04	5 752 03	5 761 06	5 761 05	5 752 06	5 761 00	5 752 05	5 761 09	5 761 03	5 761 04	5 761 07
5 752 14	5 752 13	5 761 26	5 761 25	5 752 16	5 761 20	5 752 15	5 761 29	5 761 23	5 761 24	5 761 27
5 751 64	5 751 63	5 761 86	5 761 85	5 751 66	5 761 80	5 751 65	5 761 89	5 761 83	5 761 84	5 761 87
5 750 74	5 750 73	5 761 66	5 761 65	5 750 76	5 761 60	5 750 75	5 761 69	5 761 63	5 761 64	5 761 67
5 750 84	5 750 83	5 761 46	5 761 45	5 750 86	5 761 40	5 750 85	5 761 49	5 761 43	5 761 44	5 761 47
5 753 74	5 753 73	5 763 76	5 763 75	5 753 76	5 763 70	5 753 75	5 763 79	5 763 73	5 763 74	5 763 77
5 767 04	5 767 03	5 767 16	5 767 15	5 767 06	5 767 10	5 767 05	5 767 19	5 767 13	5 767 14	5 767 17
-	-	-	-	-	-	-	-	-	-	-
-	-	-	-	-	-	-	-	-	-	-
5 750 94	5 750 93	5 762 16	5 762 15	5 750 96	5 762 10	5 750 95	5 762 19	5 762 13	5 762 14	5 762 17
5 751 04	5 751 03	5 762 06	5 762 05	5 751 06	5 762 00	5 751 05	5 762 09	5 762 03	5 762 04	5 762 07
5 751 24	5 751 23	5 761 96	5 761 95	5 751 26	5 761 90	-	-	-	-	-
-	-	-	-	-	-	-	-	-	-	-
-	-	-	-	-	-	-	-	-	-	-
-	-	-	-	-	-	-	-	-	-	-
5 756 14	5 756 13	5 761 16	5 761 15	5 756 16	5 761 10	5 756 15	5 761 19	5 761 13	5 761 14	5 761 17
5 755 44	5 755 43	5 761 56	5 761 55	5 755 46	5 761 50	5 755 45	5 761 59	5 761 53	5 761 54	5 761 57
5 755 64	5 755 63	5 761 76	5 761 75	5 755 66	5 761 70	5 755 65	5 761 79	5 761 73	5 761 74	5 761 77
5 755 54	5 755 53	5 761 36	5 761 35	5 755 56	-	-	-	-	-	-
5 767 44	5 767 43	5 767 56	5 767 55	5 767 46	-	-	-	-	-	-
5 766 84	5 766 83	5 766 96	5 766 95	5 766 86	-	-	-	-	-	-

## Arteor™ Italian / US standards plate selection charts

83.5 mm fixing centres - flush-mounting boxes, support frames and plates

Number of modules per mechanism	Flush-mounting boxes	Support frames	Plates	PLATES						
				Neutral			Tattoo	Graphic		
				White	Pearl Alu	Graphite	Edition 1	Casual	Formal	
<b>SQUARE VERSION</b>										
1 module	0 800 49	5 760 40		5 752 20	5 752 21	5 752 22	5 764 18	5 764 11	5 764 12	
2 modules and 1.2" touch screen	0 800 49	5 760 40		5 752 30	5 752 31	5 752 32	5 764 38	5 764 31	5 764 32	
3 modules	0 800 49	5 760 40		5 750 10	5 750 11	5 750 12	5 764 58	5 764 51	5 764 52	
Blanking cover plate	2" x 4"	5 760 40		5 754 10	5 754 11	5 754 12	-	-	-	
4 modules	0 800 42	5 760 11		5 750 30	5 750 31	5 750 32	5 762 78	5 762 71	5 762 72	
6 modules	0 800 43	5 760 12		5 750 40	5 750 41	5 750 42	5 762 88	5 762 81	5 762 82	
<b>ROUND VERSION</b>										
2 modules	0 800 49	5 760 40		5 756 20	5 756 21	5 756 22	5 764 28	5 764 21	5 764 22	
3 modules	0 800 49	5 760 40		5 755 00	5 755 01	5 755 02	5 764 48	5 764 41	5 764 42	
4 modules	0 800 42	2 x 5 760 21		5 755 10	5 755 11	5 755 12	5 762 58	5 762 51	5 762 52	
6 modules	0 800 43	3 x 5 760 21		5 755 20	5 755 21	5 755 22	-	-	-	

PLATES											
Mirror				Brushed metal		Wood		Leather		Signature	
Mirror White	Mirror Black	Mirror Red	Mirror Taupe	Stainless Steel	Gold Brass	Wenge Style	Light Oak	Club	Galuchat	Woven Metal	
											
5 752 44	5 752 43	5 764 16	5 764 15	5 752 46	5 764 10	5 752 45	5 764 19	5 764 13	5 764 14	5 764 17	
5 752 54	5 752 53	5 764 36	5 764 35	5 752 56	5 764 30	5 752 55	5 764 39	5 764 33	5 764 34	5 764 37	
5 752 74	5 752 73	5 764 56	5 764 55	5 752 76	5 764 50	5 752 75	5 764 59	5 764 53	5 764 54	5 764 57	
-	-	-	-	-	-	-	-	-	-	-	
5 750 34	5 750 33	5 762 76	5 762 75	5 750 36	5 762 70	5 750 35	5 762 79	-	-	-	
5 750 44	5 750 43	5 762 86	5 762 85	5 750 46	5 762 80	5 750 45	-	-	-	-	
5 756 34	5 756 33	5 764 26	5 764 25	5 756 36	5 764 20	5 756 35	5 764 29	5 764 23	5 764 24	5 764 27	
5 756 54	5 756 53	5 764 46	5 764 45	5 756 56	5 764 40	5 756 55	5 764 49	5 764 43	5 764 44	5 764 47	
5 755 14	5 755 13	5 762 56	5 762 55	5 755 16	5 762 50	-	-	-	-	-	
5 755 24	5 755 23	-	-	5 755 26	-	-	-	-	-	-	

# Arteor™ American and South African standard plate selection charts

83.5 mm fixing centres - flush-mounting boxes, support frames and plates

Number of modules per mechanism	Flush-mounting boxes	Support frames	Plates	PLATES					
				Neutral			Tattoo	Graphic	
				White	Pearl Alu	Graphite	Edition 1	Casual	Formal
<b>SQUARE VERSION</b>									
1 vertical module	2" x 4"	5 760 30		5 767 20	5 767 21	5 767 22	5 767 38	5 767 31	5 767 32
1 horizontal module		5 760 40		5 752 40	5 752 41	5 752 42	5 764 18	5 764 11	5 764 12
2 modules and 1.2" touch screen		5 760 30 <sup>(1)</sup> 5 760 40		5 752 50	5 752 51	5 752 52	5 764 38	5 764 31	5 764 32
3 modules		5 760 40		5 752 70	5 752 71	5 752 72	5 764 58	5 764 51	5 764 52
2 modules	4" x 4"	5 760 31		5 752 60	5 752 61	5 752 62	5 766 28	5 766 21	5 766 22
3 modules		5 760 31		5 752 80	5 752 81	5 752 82	5 766 48	5 766 41	5 766 42
4 modules		5 760 31		5 752 90	5 752 91	5 752 92	5 766 58	5 766 51	5 766 52
2 x 3 modules		5 760 32		5 753 00	5 753 01	5 753 02	5 766 78	5 766 71	5 766 72
Video display internal unit 2.5"		Not needed		-	-	-	-	-	-
Blanking cover plate Italian / US standards	2" x 4"	5 760 40		5 754 10	5 754 11	5 754 12	-	-	-
Blanking cover plate US standard	4" x 4"	5 760 31		5 753 60	5 753 61	5 753 62	-	-	-
Central unit for: - temperature control - intruder alarm	Supplied with box	Not needed		-	-	-	-	-	-
<b>ROUND VERSION</b>									
2 modules	2" x 4"	5 760 30 <sup>(1)</sup> 5 760 40		5 756 30	5 756 31	5 756 32	5 764 28	5 764 21	5 764 22
3 modules		5 760 40		5 756 50	5 756 51	5 756 52	5 764 48	5 764 41	5 764 42
2 modules	4" x 4"	5 760 31		5 756 40	5 756 41	5 756 42	5 766 18	5 766 11	5 766 12
3 modules				5 756 60	5 756 61	5 756 62	5 766 38	5 766 31	5 766 32
2 x 3 modules				5 756 70	5 756 71	5 756 72	5 766 68	5 766 62	5 766 61

1: Only for 2 modules electronic functions



PLATES

PLATES											
Mirror				Brushed metal		Wood		Leather		Signature	
Mirror White	Mirror Black	Mirror Red	Mirror Taupe	Stainless Steel	Gold Brass	Wenge Style	Light Oak	Club	Galuchat	Woven Metal	
5 767 24	5 767 23	5 767 36	5 767 35	5 767 26	5 767 30	5 767 25	5 767 39	5 767 33	5 767 34	5 767 37	
5 752 44	5 752 43	5 764 16	5 764 15	5 752 46	5 764 10	5 752 45	5 764 19	5 764 13	5 764 14	5 764 17	
5 752 54	5 752 53	5 764 36	5 764 35	5 752 56	5 764 30	5 752 55	5 764 39	5 764 33	5 764 34	5 764 37	
5 752 74	5 752 73	5 764 56	5 764 55	5 752 76	5 764 50	5 752 75	5 764 59	5 764 53	5 764 54	5 764 57	
5 752 64	5 752 63	5 766 26	5 766 25	5 752 66	5 766 20	5 752 65	5 766 29	5 766 23	5 766 24	5 766 27	
5 752 84	5 752 83	5 766 46	5 766 45	5 752 86	5 766 40	5 752 85	5 766 49	5 766 43	5 766 44	5 766 47	
5 752 94	5 752 93	5 766 56	5 766 55	5 752 96	-	-	-	-	-	-	
5 753 04	5 753 03	5 766 76	5 766 75	5 753 06	5 766 70	-	-	-	-	-	
5 764 84	5 764 83	-	-	5 764 86	-	-	-	-	-	-	
-	-	-	-	-	-	-	-	-	-	-	
-	-	-	-	-	-	-	-	-	-	-	
5 765 24	5 765 23	-	-	-	-	-	-	-	-	-	
5 756 34	5 756 33	5 764 26	5 764 25	5 756 36	5 764 20	5 756 35	5 764 29	5 764 23	5 764 24	5 764 27	
5 756 54	5 756 53	5 764 46	5 764 45	5 756 56	5 764 40	5 756 55	5 764 49	5 764 43	5 764 44	5 764 47	
5 756 44	5 756 43	5 766 16	5 766 15	5 756 46	5 766 10	5 756 45	5 766 19	5 766 13	5 766 14	5 766 17	
5 756 64	5 756 63	5 766 36	5 766 35	5 756 66	5 766 30	5 756 65	5 766 39	5 766 33	5 766 34	5 766 37	
5 756 74	5 756 73	5 766 66	5 766 65	5 756 76	-	-	-	-	-	-	

# Arteor™ German and French standard plate selection charts

60 mm fixing centres - flush and surface-mounting boxes, support frames and plates

Number of modules per mechanism	Surface-mounting boxes	Flush-mounting boxes for dry partitions <sup>(1)</sup>	Support frames	Plates	PLATES					
					Neutral			Tattoo	Graphic	
					White	Pearl Alu	Graphite	Edition 1	Casual	Formal
<b>SQUARE VERSION</b>										
1 module	-	0 800 41	5 760 21 (screws) 5 760 20 (claws)		5 765 40	5 765 41	5 765 52	5 762 28	5 762 21	5 762 22
2 modules and 1.2" touch screen	5 723 90	0 800 41	5 760 21 (screws) 5 760 20 (claws)		5 765 60	5 765 61	5 765 62	5 762 48	5 762 41	5 762 42
3 modules	-	0 800 49	5 760 40		5 750 10	5 750 11	5 750 12	5 764 58	5 764 51	5 764 52
2 x 2 modules	5 723 92	0 800 42	2 x 5 760 21		5 750 20	5 750 21	5 750 22	5 762 68	5 762 61	5 762 62
6 modules	-	0 800 43	5 760 12		5 750 40	5 750 41	5 750 42	5 762 88	5 762 81	5 762 82
2 x 6 modules	5 723 96	0 801 26	5 760 22		5 750 60	5 750 61	5 750 62	-	-	-
4 modules	5 723 92	0 800 42	5 760 11		5 750 30	5 750 31	5 750 32	5 762 78	5 762 71	5 762 72
3 x 2 modules	-	0 800 43	3 x 5 760 21		5 750 50	5 750 51	5 750 52	-	-	-
<b>ROUND VERSION</b>										
2 x 1 module 2 modules	5 723 90	0 800 41	5 760 21 (screws) 5 760 20 (claws)		5 756 00	5 756 01	5 756 02	5 762 38	5 762 31	5 762 32
2 x 2 modules	5 723 92	0 800 42	2 x 5 760 21		5 755 10	5 755 11	5 755 12	5 762 58	5 762 51	5 762 52
3 x 2 modules	-	0 800 43	3 x 5 760 21		5 755 20	5 755 21	5 755 22	-	-	-

1: Other flush-mounting boxes (see p. 565)

PLATES

PLATES											
Mirror				Brushed metal		Wood		Leather		Signature	
Mirror White	Mirror Black	Mirror Red	Mirror Taupe	Stainless Steel	Gold Brass	Wenge Style	Light Oak	Club	Galuchat	Woven Metal	
5 765 54	5 765 53	5 762 26	5 762 25	5 765 56	5 762 20	5 765 55	5 762 29	5 762 23	5 762 24	5 762 27	
5 765 64	5 765 63	5 762 46	5 762 45	5 765 66	5 762 40	5 765 65	5 762 49	5 762 43	5 762 44	5 762 47	
5 752 74	5 752 73	5 764 56	5 764 55	5 752 76	5 764 50	5 752 75	5 764 59	5 764 53	5 764 54	5 764 57	
5 750 24	5 750 23	5 762 66	5 762 65	5 750 26	5 762 60	5 750 25	5 762 69	5 762 63	5 762 64	5 762 67	
5 750 44	5 750 43	5 762 86	5 762 85	5 750 46	5 762 80	5 750 45	-	-	-	-	
-	-	-	-	-	-	-	-	-	-	-	
5 750 34	5 750 33	5 762 76	5 762 75	5 750 36	5 762 70	5 750 35	5 762 79	-	-	-	
5 750 54	5 750 53	-	-	5 750 56	-	-	-	-	-	-	
5 756 04	5 756 03	5 762 36	5 762 35	5 756 06	5 762 30	5 756 05	5 762 39	5 762 33	5 762 34	5 762 37	
5 755 14	5 755 13	5 762 56	5 762 55	5 755 16	5 762 50	5 755 15	5 762 59	-	-	5 762 57	
5 755 24	5 755 23	-	-	5 755 26	-	-	-	-	-	-	

# Arteor™ hotels solutions

From the entrance of the hotel room to the bedside table Arteor™ solutions are designed to perfectly meet customer comfort requirements for easy connection of various multimedia devices and flexible access to the internet



**DESIGNED TO ENHANCE CUSTOMER COMFORT**

■ A solution for all types of hotels



BUS/SCS SCENARIO CONTROLLERS AND CONTROLS



HOTEL EQUIPMENT WITH SPECIFIC MARKING



VIDEO OF ROOM CONTROL SYSTEM FOR HOSPITALITY BUILDINGS



KNX CONTROL MECHANISMS



STANDARD HOTEL EQUIPMENT

# Arteor™ hotel equipment

## BUS/SCS



Support frame and plate selection charts **p. 386-393**

Pack	Cat.Nos	Control indicators for room management
		<b>Mechanisms</b> To be equipped with support frames (p. 385) and plates (p. 386 to 393)
1	<b>N</b> 0 675 90	External indicator and bell pushbutton DO NOT DISTURB – MAKE UP THE ROOM
1	0 675 91	External indicator and bell pushbutton + badge reader DO NOT DISTURB – MAKE UP THE ROOM
1	0 675 93	To be completed with key covers DO NOT DISTURB – MAKE UP THE ROOM
1	0 675 92	8 push-buttons control for lighting, automation, sound diffusion and scenario functions
		<b>A5 sheets</b> For the customisation of the symbols of Cat.No 0 675 92
1	0 675 96	<input type="radio"/> White
1	0 675 95	<input checked="" type="radio"/> Magnesium

		<b>Key cover with symbols for control mechanism BUS/SCS</b>
		<b>Key cover with symbol DO NOT DISTURB - 2 modules</b>
5	<b>N</b> 5 743 46	<input type="radio"/> White
5	5 743 47	<input checked="" type="radio"/> Magnesium
5	5 743 48	<input type="radio"/> White
5	5 743 49	<input checked="" type="radio"/> Magnesium
		<b>Couple of key cover with symbol DO NOT DISTURB and symbol PLEASE CLEAN THE ROOM</b>
2	5 743 94	<input type="radio"/> White
2	5 743 95	<input checked="" type="radio"/> Magnesium
2	5 743 96	<input type="radio"/> White
2	5 743 97	<input checked="" type="radio"/> Magnesium

		<b>Display thermostat</b>
1	<b>N</b> 0 674 59	Flush mounted thermostat with backlit display. To be equipped with support frames (p. 385) and plates (p. 386 to 393) It can be used to control the temperature of an individual zone, both if a temperature central unit is and is not present. It features a temperature probe and an input for the connection of a contact line (e.g. window contact). It can be used for the management of different types of systems, and the adjustment of the fan speed when fan coils are used Possibility of automatic operation (summer/winter), with compatible systems 2 modules

Pack	Cat.Nos	Keycard switches BUS/SCS
		Equipped with rocker plates, to be equipped with support frames (p. 385) and plates (p. 386 to 393) For energizing a circuit by inserting a key fob Time delay of approx. 30 sec. after card removal Lighting of the slot by LED 2 modules
		<b>Mechanical keycard switch</b>
1	5 722 35	<input type="radio"/> White
1	5 727 35	<input checked="" type="radio"/> Magnesium
		<b>RFID keycard switch</b> Only works with ISO 13.56 MHz badges
1	5 722 36	<input type="radio"/> White
1	5 727 36	<input checked="" type="radio"/> Magnesium
		<b>Scenario controllers BUS/SCS</b>
		Touch control plates, supplied complete, to be installed in flush-mounting boxes
		<b>4-scene touch control - 4 scenarios</b> "wake up / sleep / TV / relax" scenarios - 2 modules For BS flush-mounting boxes
1	5 740 89	<input type="radio"/> White
1	5 745 89	<input checked="" type="radio"/> Black
		<b>6-scene touch control - 6 scenarios</b> "wake up / sleep / TV / relax / open curtains / close curtains" scenarios - 3 modules For British, Italian and American flush-mounting boxes
1	5 740 91	<input type="radio"/> White
1	5 745 91	<input checked="" type="radio"/> Black
		<b>Accessories</b>
		Sheet with stickers with symbols for different scenarios for hotel rooms
1	5 740 92	Dark colour
1	5 745 92	White colour



Pack	Cat.Nos	DIN rail actuators 100/240 VA - 50/60 Hz
1	0 035 17 	<b>Actuator with 8 independent relays</b> For the control of on-off valves, motorised valves (open-close and three points), pumps and fan coils with 2 and 4 tubes – 4A resistive, 1A motor valves, pumps and fan-coils 4 DIN modules
1	0 035 19 	<b>Actuator with 3 independent relays and 2 x 0-10 Volts outputs</b> For the control of fan coils with 2 and 4 tubes with proportional 0-10 Volt valves – 4A resistive, 1A fan coil 4 DIN modules
1	0 035 18 	<b>Actuator with 2 x 0-10 Volt outputs</b> For the control of 0-10 proportional valves 2 DIN modules
1	0 035 79	<b>Actuator with 2 independent relays</b> For single and double loads: 6 A resistive, 3 A motorised valves and pumps 2 DIN modules 17.5 mm
1	0 035 80	<b>Actuator with 4 independent relays</b> For single, double or mixed loads: 6 A resistive, 3 A motorised valves, pumps and fan-coils 2 DIN modules 17.5 mm
1	0 035 93	<b>IP scenario module</b> It manages scenarios related to hotel rooms (With basic time and logic conditions) - It works as a gateway for the Configuration software
		<b>Software</b> Software for the monitoring of the status of the room, for the corresponding basic management and the programming of badges
1	0 035 95	For hotels with up to 20 rooms
1	0 035 96	For hotels over 20 rooms
10	0 675 89	<b>Badge</b> Credit card shaped badge (ISO 50 x 80 mm) It uses transponder technology with frequency 13.56 MHz To be used with programmer Cat.BNo BT-348402 The badge can be customized and is sold in packs of 10
1	BT-348402	<b>Programmer</b> Desk device to be connected to the PC (in the reception) to program badges



Pack	Cat.Nos	KNX control mechanisms
		Support frame and plate selection charts <b>p. 386-393</b> Support frame and plate selection charts <b>p. 386-393</b> Directly connected to the KNX BUS (supplied with KNX connectors) Programming through ETS software
1	0 675 71 	<b>Mechanism to be equipped</b> 4 actuation points To be equipped with key covers for control mechanism (p. 395 and 408)
1	5 742 03	<b>Square version</b> 4 actuation points - With label holder ○ White
1	5 744 04	● Magnesium
1	5 735 02	<b>Round version</b> 4 actuation points - With label holder ○ White
1	5 735 03	● Magnesium
1	5 735 04	<b>KNX touch control mechanisms</b> For lighting control (ON/OFF, dimming, scenario...), shutters and slats controls and automation control Equipped with programmable LEDs (12 colours available) to indicate the status of the loads and provide system and alarm status feedback Supplied with glass plates Upon request, customization of plates possible with any other standard symbols (please contact us)
1	5 735 05	<b>4 actuation points</b> ○ White ● Black
1	5 735 12	<b>6 actuation points</b> ○ White
1	5 735 13	● Black
1	0 490 29	<b>KNX thermostats</b> For fan coil units: 2 tubes, 2 tubes + 2 wires and 4 tubes for heating and/or air conditioning For controlling on/off valves, 3 positions and 3 speeds (fan): comfort, economy and protection with manual or automatic selection. Adjustment accuracy + 0.5 °C 2 multi-function inputs for window contacts, summer/winter changeover, etc Backlit display Operating voltage 230 V± Supplied complete with flush-mounting box
1	0 490 30	○ White ● Black

# Arteor™ hotel equipment

## wiring devices



Support frame and plate selection charts **p. 386-393**

Mechanisms supplied with rocker plates, to be equipped with support frames (p. 385) and plates (p. 386 to 393)

Pack	Cat.Nos	Mechanical key card switches
1	5 722 30	<p>For energizing a circuit by inserting a key fob Cat.No 5 722 59 or a smart card (access card for a hotel room) Example of use: hotel room power supply only when guest is present Time-delay of approx. 30 sec. after card removal To be equipped with single pole latching relay Cat.Nos 5 722 27 or 5 727 27 (p. 367) 2 modules</p> <p><b>Key card switches 230 V</b></p> <p><input type="radio"/> White <input checked="" type="radio"/> Magnesium</p>
1	5 727 30	

Pack	Cat.Nos	Key card switches RFID
1	5 722 53	<p>For energizing a circuit for example meeting room, office, hotel room... Works only with ISO type contactless key card Cat.Nos 0 767 11/12/13 or other ISO type 13.56 MHz key card Time-delay of approx. 30 sec. after card removal Low capacity contact 230 V - 30 VA Lighting of the slot by LED 2 modules</p> <p><input type="radio"/> White <input checked="" type="radio"/> Magnesium</p>
1	5 727 53	

Pack	Cat.Nos	Key card
10	5 722 59	<p><b>For mechanical key card switches</b></p> <p>Enables use of key fob switches in hotels with key locks Supplied complete with a label holder for individual hotel identification</p> <p><input type="radio"/> White <input checked="" type="radio"/> Magnesium</p>
10	5 727 59	
10	0 767 11	<p><b>For RFID key card switches</b></p> <p>MIFARE contactless badge card ISO format (50 x 80 mm) Chip: 13.56 MHz Standard 1 KB memory</p>

Pack	Cat.Nos	Shaver sockets
1	5 721 55	<p>Conform to BS EN 61558-2-5 IP 24 For use with European, British, American, Australian 2-pin plugs Screwless live and neutral terminals Double wound isolating transformer Automatic self-resetting overload feature Plug insertion operates micro-switch which energises transformer To be equipped with BS 2 gang - 3-module plates (p. 386, 387) For flush-mounting boxes, use BS 2 gang box depth 48 mm, US type, Italian type boxes depth 48 mm or Cat.No 0 801 55 Power supply: 230 V - 50/60 Hz 3 modules</p> <p><b>230 V / 120-230 V</b></p> <p><input type="radio"/> White <input checked="" type="radio"/> Magnesium</p>
1	5 726 55	
1	5 721 53	<p><b>230 V / 120-230 V with earth connector</b></p> <p><input type="radio"/> White <input checked="" type="radio"/> Magnesium</p>
1	5 726 53	

Pack	Cat.Nos	Chimes
1	5 722 06	<p>230 V - 50 Hz Consumption: 65 mA 1 melody Tone level: 73 dB at 1 m Compatible with push-button Cat.No 0 416 45</p> <p><input type="radio"/> White <input checked="" type="radio"/> Magnesium</p>
1	5 722 46	



5 733 82



5 737 22



5 720 57



5 725 54



5 722 24

Support frame and plate selection charts p. 386-393

Mechanisms supplied with rocker plates, to be equipped with support frames (p. 385) and plates (p. 386 to 393)

Pack	Cat.Nos	Lighting control
10	5 732 84	<b>Master switch - 2 modules</b> 2-way double pole 20 AX - 250 V~ for general control: all ON / all OFF ○ White ● Magnesium
10	5 737 84	
10	5 732 86	<b>Master push-button - 2 modules</b> 2-way 6 A - 250 V~ for general control: all ON/ all OFF ○ White ● Magnesium
10	5 737 86	
10	5 732 94	<b>Switch for bed lights - 2 x 1 module</b> 2 x 2-way switch - 10 AX - 250 V~ ○ White ● Magnesium
5	5 737 94	
10	5 732 96	<b>Push-button for bed lights - 2 x 1 module</b> 2 x 2-way push-button - 6 A - 250 V~ ○ White ● Magnesium
5	5 737 96	
10	5 733 82	<b>Switch for desk and entrance lights - 2 x 1 module</b> 2 x 2-way switch - 10 AX - 250 V~ ○ White ● Magnesium
5	5 738 82	
10	5 733 84	<b>Push-button for desk and entrance lights - 2 x 1 module</b> 2 x 2-way push-button - 6 A - 250 V~ ○ White ● Magnesium
5	5 738 84	
<b>Electric roller blinds control - 250 VA</b>		
10	5 732 22	<b>Double switch 10 A - 2 modules</b> For direct control of a motor (mechanism with fixed positions) ○ White ● Magnesium
10	5 737 22	
10	5 732 24	<b>Double push-button 10 A - 2 modules</b> For control via automatic box (N/O mechanism) ○ White ● Magnesium
10	5 737 24	
<b>Curtain control - 250 VA</b>		
10	5 732 34	<b>Double switch 10 A - 2 modules</b> For direct control of a motor (mechanism with fixed positions) ○ White ● Magnesium
10	5 737 34	
10	5 732 36	<b>Double push-button 10 A - 2 modules</b> For control via automatic box (N/O mechanism) ○ White ● Magnesium
10	5 737 36	

Pack	Cat.Nos	Hotel bedroom call indicators
		Enable the resident to inform hotel staff of the room status Two settings are possible: - Do not disturb - Please clean the room 2 x 1 module
5	5 720 57	<b>Indicator for corridor</b> Indicator lamp and bell push Installed in the corridor, display calls Supplied with LED ○ White ● Magnesium
5	5 725 57	
5	5 720 54	<b>Internal control unit</b> Allows the user to select the desired setting Supplied with LED ○ White ● Magnesium
5	5 725 54	
<b>Illuminated signs</b>		
		Mechanisms integrating LEDs and a pivoting window that can take customised labels (printed using a simple text editor on transparent printing paper) 2 modules
		<b>Green or red LEDs</b> Sign with 2-state LEDs with choice of green or red configurable on the mechanism Power level: 1 W
5	5 722 24	○ White ● Magnesium
5	5 727 24	
		<b>Blue LEDs</b> Sign with blue LEDs A choice of 2 power levels: 0.2 or 1 W
5	5 722 25	○ White ● Magnesium
5	5 727 22	
<b>Buzzers</b>		
10	5 722 04	<b>230 V - 1 module</b> ○ White ● Magnesium
5	5 727 04	
10	5 722 07	<b>230 V - 2 modules</b> ○ White ● Magnesium
10	5 722 47	
10	5 722 45	<b>8 V - 2 modules</b> ● Magnesium

Shaver sockets and key card switches, p. 397





# Arteor™ hotel equipment

round version



5 732 95



5 737 35



5 725 67



5 725 74

Support frame and plate selection charts p. 386-393

Mechanisms supplied with rocker plates, to be equipped with support frames (p. 385) and plates (p. 386 to 393)

Pack	Cat.Nos	Lighting control
10	5 732 85	<b>Master switch - 2 modules</b> 2-way double pole 20 AX - 250 V~ for general control: all ON / all OFF ○ White ● Magnesium
10	5 737 85	
10	5 732 87	<b>Master push-button - 2 modules</b> 2-way 6 A - 250 V~ for general control: all ON/ all OFF ○ White ● Magnesium
10	5 737 87	
5	5 732 95	<b>Switch for bed lights - 2 x 1 module</b> 2 x 2-way switch - 10 AX - 250 V~ ○ White ● Magnesium
5	5 737 95	
5	5 732 97	<b>Push-button for bed lights - 2 x 1 module</b> 2 x 2-way push-button - 6 A - 250 V~ ○ White ● Magnesium
5	5 737 97	
5	5 733 83	<b>Switch for desk and entrance lights - 2 x 1 module</b> 2 x 2-way switch - 10 AX - 250 V~ ○ White ● Magnesium
5	5 738 83	
5	5 733 85	<b>Push-button for desk and entrance lights 2 x 1 module</b> 2 x 2-way push-button - 6 A - 250 V~ ○ White ● Magnesium
5	5 738 85	
		<b>Electric roller blinds control - 250 VA</b>
10	5 732 23	<b>Double switch 10 A - 2 modules</b> For direct control of a motor (mechanism with fixed positions) ○ White ● Magnesium
10	5 737 23	
10	5 732 25	<b>Double push-button 10 A - 2 modules</b> For control via automatic box (N/O mechanism) ○ White ● Magnesium
10	5 737 25	
		<b>Curtain control - 250 VA</b>
10	5 732 35	<b>Double switch 10 A - 2 modules</b> For direct control of a motor (mechanism with fixed positions) ○ White ● Magnesium
10	5 737 35	
10	5 732 37	<b>Double push-button 10 A - 2 modules</b> For control via automatic box (N/O mechanism) ○ White ● Magnesium
10	5 737 37	

Pack	Cat.Nos	Hotel bedroom call indicators
		Enable the resident to inform hotel staff of the room status Two settings are possible: - Do not disturb - Please clean the room 2 x 1 module
5	5 720 67	<b>Indicator for corridor</b> Indicator lamp and bell push Installed in the corridor, display calls Supplied with LED ○ White ● Magnesium
5	5 725 67	
5	5 720 74	<b>Internal control unit</b> Allows the user to select the desired setting Supplied with LED ○ White ● Magnesium
5	5 725 74	
		<b>Illuminated signs</b>
		Mechanisms integrating LEDs and a pivoting window that can take customised labels (printed using a simple text editor on transparent printing paper) 2 modules
		<b>Green or red LEDs</b> Sign with 2-state LEDs with choice of green or red configurable on the mechanism 1-way ● Magnesium
5	5 727 25	<b>Blue LEDs</b> Sign with blue LEDs A choice of 2 power levels: 0.2 or 1 W ● Magnesium
5	5 727 23	
		<b>Buzzers</b>
10	5 722 08	<b>230 V - 2 modules</b> ○ White ● Magnesium
10	5 722 48	

RJ 45 and audio/video sockets, p. 375 to 382



# HOME AUTOMATION & HOME NETWORK

## Arteor Radio/ ZigBee® technology



**NEW**  
P. 402  
Key cover  
selection charts

## Arteor BUS/SCS technology



**NEW**  
P. 408  
Key cover  
selection charts



**NEW**  
P. 418  
Sound diffusion



P. 424  
Classic Home  
Network

## Home Network



P. 433  
Internal optical  
termination device

## NEW PRODUCTS 2014



**Arteor  
Radio/ZigBee®**  
mechanisms and  
key covers for a  
complete product  
(p. 402)



**Arteor  
BUS/SCS**  
mechanisms and key  
covers for a complete  
product  
(p. 408)

# MyHOME<sup>®</sup> automation

The answer for all home automation requirements, from a single function to global integrated solutions.

My Home Legrand supports 2 technologies:  
Radio using ZigBee<sup>®</sup> protocol and BUS using SCS protocol.



**NEW**  
**P. 403**  
Lighting and roller blinds controllers/receivers



**NEW**  
**P. 404**  
Lighting and roller blinds transmitters



**NEW**  
**P. 404**  
Scenario controllers



**P. 405**  
Other functions



**NEW**  
**P. 409**  
Lighting control and automation



**NEW**  
**P. 411**  
Modular equipment for lighting control and automation



**NEW**  
**P. 414**  
Temperature control



**P. 416**  
Intruder alarm



**P. 420**  
Energy and load shielding management



**NEW**  
**P. 421**  
Home system and door entry system



**P. 426**  
Evolutive Home Network



**P. 428**  
Evolutive + Home Network



**NEW**  
**P. 432**  
FTTH  
Fibre to the Home preterminated solution



**P. 432**  
FTTH  
Fibre to the Home prewired solution



VISIT ARTEOR  
VIRTUAL HOUSE



**MyHome Screen 3.5\" and 10\"**  
colour touch screens for home system management  
(p. 421)



**FTTH**  
**Fibre To The Home**  
preterminated and prewired solution  
(p. 432)



5 745 58



5 745 61



5 745 67



5 745 96



5 745 80



5 745 82

Key cover description	ROUND VERSION		SQUARE VERSION			
		White ○	Black ●		White ○	Black ●
Lighting switch 1 circuit		5 745 55	5 745 56		5 745 73	5 745 74
Lighting switch 2 circuits		5 745 57	5 745 58		5 745 75	5 745 76
Lighting switch 3 circuits		5 745 59	5 745 60		5 745 96	5 745 97
Lighting dimmer with blue LED bargraph		5 745 61	5 745 62	-	-	-
Lighting dimmer without blue LED bargraph		5 745 63	5 745 64		5 745 81	5 745 82
Lighting dimmer 2 circuits with blue LED bargraph		5 745 65	5 745 66		5 745 79	5 745 80
Roller blind control		5 745 67	5 745 68		5 745 83	5 745 84
4 scenario controller		5 745 69	5 745 70		5 745 77	5 745 78
False key cover		5 745 71	5 745 72		5 745 85	5 745 86

For a complete product:



=



Mechanism

+



Key cover

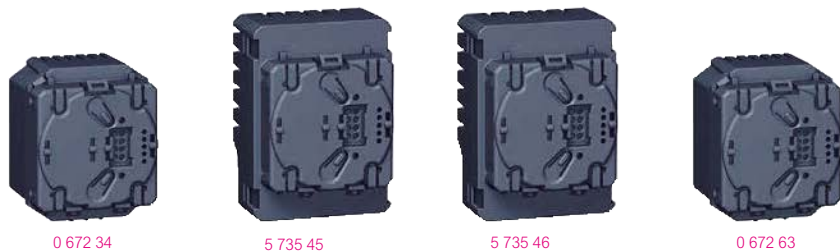

Support frame and plate selection charts **p. 386-393**. Load selection charts **p. 407**  
Key cover selection charts **p. 402**

Receivers to be equipped with round or square key cover (p. 402) and with 2-module plates (p. 386 to 393)

To be installed in flush-mounting boxes min. depth 40 mm

To be equipped with 2-module support frames

Connect to the load and can be controlled by remote control transmitters, scenario switches, mobile control units and detectors (p. 404 to 406)

Pack	Cat.Nos	<b>Lighting controllers/receivers (switches)</b> <b>100/240 VA</b>	Pack	Cat.Nos	<b>Lighting controllers/receivers (dimmers)</b> <b>100/240 VA</b>
1	0 672 31	<p>Each active button on the receivers is identified by LED (blue LED indicator status supplied)</p> <p><b>Switch without neutral - 300 W - 1 circuit</b> To be equipped with round or square key cover, see selection chart (p. 402)</p>	1	0 672 37	<p>Each active button on the receivers is identified by LED (with blue LED bargraph)</p> <p><b>Leading/trailing edge dimmer without neutral - 300 W</b> To be equipped with round or square key cover, see selection chart (p. 402)</p>
1	5 735 44	<p><b>Switch without neutral - 2 x 300 W - 2 circuits</b> Supplied with support frame To be equipped with round or square key cover, see selection chart (p. 402)</p>	1	5 735 46	<p><b>Leading/trailing edge dimmer without neutral - 600 W</b> To be equipped with round or square key cover, see selection chart (p. 402)</p>
1	0 672 33	<p><b>Switch with neutral - 2500 W - 1 circuit</b> To be equipped with round or square key cover, see selection chart (p. 402)</p>	1	5 735 49	<p><b>Leading/trailing edge dimmer without neutral - 2 x 300 W</b> Supplied with support frame To be equipped with round or square key cover, see selection chart (p. 402)</p>
1	0 672 34	<p><b>Switch with neutral - 2 x 1000 W - 2 circuits</b> To be equipped with round or square key cover, see selection chart (p. 402)</p>	1	5 735 47	<p><b>Universal dimmer with neutral - 400 W</b> To be equipped with round or square key cover, see selection chart (p. 402)</p>
1	5 735 45	<p><b>Switch with neutral - 3 x 1000 W - 3 circuits</b> To be equipped with round or square key cover, see selection chart (p. 402)</p>	1	5 735 48	<p><b>0-10 V dimmer</b> To be equipped with round or square key cover, see selection chart (p. 402)</p>
1	0 672 63	<p><b>Roller blind controller/receiver - 100/240 VA</b> With neutral To be equipped with round or square key cover, see selection chart (p. 402)</p>	1	0 672 63	<p><b>Roller blind controller/receiver - 100/240 VA</b> With neutral To be equipped with round or square key cover, see selection chart (p. 402)</p>

ZigBee®: Certified product Manufacturer Specific Profile



0 672 35

Support frame and plate selection charts p. 386-393  
Key cover selection charts p. 402

To be equipped with round or square key cover (p. 402) 2-module plate (p. 386 to 393) and multi-standard support frame (with removable fins)  
Cat.No 5 735 51  
Surface mounting with direct fixing of support frame on wall  
Control one or more Radio/ZigBee® receivers  
No wiring needed  
Supplied with batteries

Pack	Cat.Nos	Lighting remote control transmitters
1	0 672 35	<b>For 1 circuit switch controllers</b> To be equipped with round or square key cover, see selection chart (p. 402)
1	0 672 36	<b>For 2 circuit switch controllers</b> To be equipped with round or square key cover, see selection chart (p. 402)
1	0 672 39	<b>For dimmer controllers</b> To be equipped with round or square key cover, see selection chart (p. 402)
1	0 672 64	<b>Roller blind control transmitter</b> <b>For roller blind controllers</b> To be equipped with round or square key cover, see selection chart (p. 402)



5 738 70

0 882 32

0 883 07

Support frame and plate selection charts p. 386-393

Pack	Cat.Nos	Wall mounting scenario controller
1	0 672 40	To be equipped with round or square key cover (p. 402), 2-module plate (p. 386 to 393) and multi-standard support frame (with removable fins) Cat.No 5 735 51 Standard rocker plates and plates can be replaced by touch plates Surface mounting with direct fixing of support frame on wall No wiring needed Supplied with batteries <b>4-scenario controller</b> 4 push-buttons to control 4 scenarios (1 scenario can control several functions: shutters, lighting...) To be equipped with round or square key cover, see selection chart (p. 402)
1	5 737 90	<b>Touch plates for scenario controller</b> <b>British standard touch plates</b> ○ White ● Black
1	5 737 91	
1	5 737 92	<b>Italian and American standard touch plates</b> ○ White ● Black
1	5 737 93	
1	5 735 51	<b>Multistandard support frame</b> For scenario controllers, light and roller blind transmitter Radio/ZigBee®
1	5 738 70	<b>Mobile scenario controllers</b> 1 scenario can control several functions: lighting level adjustment, roller blinds, general ON or OFF... <b>Pocket scenario controller</b> 4-scenario controller For Radio/ZigBee® installation Supplied with batteries
1	0 882 32	<b>Radio/ZigBee® - IR remote control</b> 5-scenario controller Supplied with batteries
1	0 883 07	<b>Mobile scenario controller</b> 6-scenario controller Can control a dimmer group by high volt contact Supplied with batteries

ZigBee®: Certified product Manufacturer Specific Profile

# Arteor™

## other functions Radio/ZigBee®



Load selection charts p. 407

Pack	Cat.Nos	Radio/ZigBee® micromodule switch	Pack	Cat.Nos	Plexo Programme radio transmitter/receiver switch
1	0 883 05	<p>1 output - 300 W Enables control points to be added to improve an existing installation without damage to the walls Controls energy-saving, LED, halogen and incandescent bulbs To be installed near the lamp with neutral with Cat. No 0 306 54 (plug-in ceiling rose) for example Its receiver function is used to execute commands received from scenario switches, centralised control units, etc (p. 404, 406) Phase/neutral power supply</p>	1	0 695 03	<p>2500 W Its transmitter function allows it to control another lighting Radio/Zigbee® receiver switch Its receiver function is used to execute commands received from centralised control units, scenario switches, mobile control units, etc (p. 404, 406) 3-wire installation in box depth 40 mm min.</p>
		<p><b>Transmitter/receiver mobile sockets</b> Connect directly to an existing 2P+E socket to switch the light connected to the socket Its receiver function is used to execute commands received from scenario switches, centralised control units, etc (p. 404, 406)</p> <p><b>Radio/ZigBee® mobile dimmer switch-sockets</b> 500 VA 2 lighting levels (factory-preset and modifiable by the user)</p>			<p><b>Weatherproof radio individual blind switch for mounting in a head rail with slat orientation</b></p> <p>1</p> <p>0 883 26</p> <p><b>N</b></p> <p>Controls motors (without encoder) electric blinds for lowering/raising/stopping the blind Installed in the loft or in the blind head rail during modernisation of an existing blind without damage to the walls Must be used together with a centralised switch Cat.No 0 672 64 Must remain accessible for any programming necessary Maximum loads supported in 230 VA: 1 x 500 VA</p>
1	0 883 22	<p>German standard</p>			<p><b>Radio transmitter/receiver multifunction switches - 230 VA</b></p> <p>Switches for controlling 1 or 2 circuits connected to its terminals according to 3 different operating modes: time-lag switch, switch, remote control switch Its receiver function is used to execute, on its circuits, on/off commands received from individual control units, centralised control units, scenario switches, mobile control units, etc (p. 404, 406) Phase/neutral power supply</p>
1	0 883 20	<p>British standard</p>			<p>1</p> <p>5 738 58</p> <p>Weatherproof multifunction switch 2500 W</p>
1	0 883 25	<p><b>Radio/ZigBee® switch-sockets</b> 10 A</p> <p>German standard</p>			<p>1</p> <p>5 738 60</p> <p>Weatherproof multifunction 2-gang switch 2 x 2500 W</p>
1	0 883 23	<p>British standard</p>			
		<p><b>Transmitter/receiver control units for false ceiling - 100-240 VA</b></p> <p>Its receiver function is used to execute, on its circuits, on/off commands received from centralised control units, scenario switches, mobile control units, etc (p. 404, 406)</p>			
1	5 738 62	<p><b>Universal switch - phase/neutral</b> 1 output - 2500 W</p>			
1	5 738 64	<p><b>Dimmer for all loads (excluding fluorescent and LEDs) - without neutral</b> 1 output - 600 W</p>			
1	5 738 66	<p><b>Dimmer for 1-10 V ballast - phase/neutral</b> 1 output - 500 VA</p>			

ZigBee®: Certified product Manufacturer Specific Profile



0 672 50



0 883 32



Support frame and plate selection charts **p. 386-393**

Pack	Cat.Nos	Indoor temperature sensor
1	0 883 30	<p><b>IP 21</b>            For indoor use only            Setting: 2 temperature thresholds            Temperature ranges: from - 10°C to + 40°C            Can be used to initiate 2 scenarios when the temperature is higher than the high threshold or lower than the low threshold</p>
1	5 735 50 <b>N</b>	<p><b>Water-heater switch - receiver</b>            Can be activated by any other radio device            To be equipped with 2-module plates and 2-module support frame (p. 386 to 393)            To be installed in flush-mounting box min. depth 40 mm            To be equipped with round or square key cover (for 1 lighting circuit), see selection chart (p. 402)</p>
1	0 672 50 <b>N</b>	<p><b>BUS/SCS-Radio/ZigBee® Arteor gateways</b>            To be equipped with 2-module plates and 2-module support frames (p. 386 to 393)            To be installed in flush-mounting boxes min. depth 40 mm            Used to link a BUS/SCS installation and an additional Radio/ZigBee® installation            Used to control up to 32 transmitters            To be equipped with round or square false key cover, see selection chart (p. 402)</p>

Pack	Cat.Nos	Transmitters with auxiliary inputs
1	0 883 31	<p><b>Product for light control</b>            Can be used to initiate ON/OFF on closing or opening of a volt-free contact            For controlling a Radio/ ZigBee® installation using commercially-available detectors (eg: light sensitive switch, moisture sensor)            Fits behind a traditional switch, without damage to the walls, to control a Radio/ZigBee® switch</p>
1	0 883 32 <b>N</b>	<p><b>For scenario control</b>            Can be used to launch 2 scenarios when closing and opening with a volt free contact            For controlling scenario Radio/Zigbee® installation using commercially available detectors (moisture sensor, wind/sun captors or from the smoke detectors)</p>

ZigBee®: Certified product Manufacturer Specific Profile



**Switches and dimmers maximum loads at 230 V (for values at 110 V, please halve values)**

		Universal								
		Leading edge				Trailing edge				
Cat.Nos		Incandescent lamp	Halogen lamp	ELV halogen with ferromagnetic transformer	ELV halogen with electronic transformer	Fluorescent tube	Compact fluorescent lamp	LED	Fluorescent lamps with 0-10 V ballast	Reducer motor for shutter
SWITCHES	0 672 31	60 W - 300 W	60 W - 300 W	60 VA - 300 VA	60 VA - 300 VA	-	-	-	-	-
	5 735 44	2 x 60 W 2 x 300 W	2 x 60 W 2 x 300 W	2 x 60 VA 2 x 300 VA	2 x 60 VA 2 x 300 VA	-	-	-	-	-
	0 672 33	2500 W	2500 W	2500 VA	2500 VA	1250 VA	1250 VA	1250 VA	-	-
	0 672 34	2 x 1000 W	2 x 1000 W	2 x 1000 VA	2 x 1000 VA	2 x 500 VA	2 x 500 VA	2 x 500 VA	-	-
	5 735 45	3 x 1000 W	3 x 1000 W	3 x 1000 VA	3 x 1000 VA	3 x 500 VA	3 x 500 VA	3 x 500 VA	-	-
	0 672 63	-	-	-	-	-	-	-	-	500 VA
	0 883 27	-	-	-	-	-	-	-	-	500 VA
	5 738 62	2500 W	2500 W	2500 VA	2500 VA	1250 VA	1250 VA	1250 VA	-	-
	5 738 58	2500 W	2500 W	2500 VA	2500 VA	1250 VA	1250 VA	1250 VA	yes	-
	5 738 60	2 x 2500 W	2 x 2500 W	2 x 2500 VA	2 x 2500 VA	2 x 1250 VA	2 x 1250 VA	2 x 1250 VA	yes	-
	0 883 05	300 W	300 W	300 VA	300 VA	150 VA	150 VA	150 VA	-	-
	0 883 23/25	2500 W	2500 W	2500 VA	2500 VA	1250 VA	1250 VA	1250 VA	-	-
DIMMERS	0 672 37	60 W - 300 W	60 W - 300 W	60 VA - 300 VA	60 VA - 300 VA	-	-	-	-	-
	5 735 49	2 x 60 W 2 x 300 W	2 x 60 W 2 x 300 W	2 x 60 VA 2 x 300 VA	2 x 60 VA 2 x 300 VA	-	-	-	-	-
	5 735 46	600 W	600 W	450 VA	600 VA	-	-	-	-	-
	5 735 47	40 W - 300 W	40 W - 300 W	8 VA - 300 VA	8 VA - 300 VA	-	160 VA	160 VA	-	-
	5 735 48	-	-	-	-	-	-	-	1000 VA	-
	5 738 66	-	-	-	-	-	-	-	1000 VA	-
	5 738 64	600 W	600 W	450 VA	600 VA	-	-	-	-	-
	0 883 20/22	60 W/500 W	60 W/500 W	60 VA/500 VA	60 VA/500 VA	-	-	-	-	-



Key cover description	Pack	Number of modules	ROUND VERSION		SQUARE VERSION			
			White 	Magnesium 	White 	Magnesium 		
Regulation symbol left-hand side mounting	5	1		5 745 05	5 745 06		5 744 87	5 744 86
Regulation symbol right-hand side mounting	5	1		5 745 07	5 745 08		5 744 89	5 744 88
Regulation symbol	5	2		5 745 37	5 745 38		5 744 89	5 744 88
Light symbol any side mounting	5	1		5 745 17	5 745 18		5 744 75	5 744 74
Light symbol	5	2		5 745 43	5 745 44		5 744 77	5 744 76
Dimmer symbol left-hand side mounting	5	1		5 745 20	5 745 22		5 744 69	5 744 68
Dimmer symbol right-hand side mounting	5	1		5 745 19	5 745 21		5 744 71	5 744 70
Dimmer symbol	5	2		5 745 41	5 745 42		5 744 71	5 744 70
Up/Down symbol any side mounting	5	1		5 745 15	5 745 16		5 744 93	5 744 92
Up/Down symbol	5	2		5 745 35	5 745 36		5 744 95	5 744 94
GEN marking	5	2		5 745 39	5 745 40		5 744 73	5 744 72
GEN/ON/OFF marking left-hand side mounting	5	1		5 745 24	5 745 26		5 744 83	5 744 82
GEN/ON/OFF marking right-hand side mounting	5	1		5 745 23	5 745 25		5 744 85	5 744 84
GEN/ON/OFF marking	5	2		5 745 31	5 745 32		5 744 85	5 744 84
ON/OFF marking left-hand side mounting	5	1		5 745 28	5 745 30		5 744 79	5 744 78
ON/OFF marking right-hand side mounting	5	1		5 745 27	5 745 29		5 744 81	5 744 80
ON/OFF marking	5	2		5 745 33	5 745 34		5 744 81	5 744 80
Sound source selection right-hand mounting	5	1		5 745 11	5 745 12		5 744 91	5 744 90
Shutter STOP marking any side mounting	5	1		5 745 45	5 745 46		5 745 47	5 745 48
Without marking any side mounting	5	1		5 745 09	5 745 10		5 744 65	5 744 64
Without marking	5	2		5 745 13	5 745 14		5 744 67	5 744 66

# Arteor™

## lighting control and automation mechanisms BUS/SCS



Support frame and plate selection charts **p. 386-393**  
Key cover selection charts **p. 408**

Pack	Cat.Nos	Basic control mechanisms
1	0 675 52	For controlling a controller (eg: lighting, shutters or lighting + shutters) depending on the selected configuration Used to manage groups of functions and centralise them (scenario switch type) To be installed in flush-mounting boxes <b>Micropush control mechanisms</b> To be equipped with key covers (p. 408), support frames and plates (p. 386 to 393) 2 modules For controlling 1 or 2 controllers
1	0 675 54	3 modules For controlling up to 3 controllers
<b>Multi-functions control mechanisms</b>		
For controlling 1 or 2 controllers (eg: ON/OFF, shutters, scenario control) sound system, door release control, dimming: gradual switching on or off depending on the selected configuration To be installed in flush-mounting boxes <b>Micropush control mechanism</b> To be equipped with key covers (p. 408), support frames and plates (p. 386 to 393) Can control up to 4 scenarios 2 modules		
1	0 675 53	
<b>Touch control mechanisms - 2 modules</b>		
Supplied complete, equipped with white or black touch plates Can control up to 4 scenarios		
1	5 739 04	○ White - for BS flush-mounting boxes
1	5 739 05	● Black - for BS flush-mounting boxes
1	5 739 06	○ White - for 2"x 4" flush-mounting boxes
1	5 739 07	● Black - for 2"x 4" flush-mounting boxes
<b>Touch control mechanisms - 3 modules</b>		
Supplied complete, equipped with white or black touch plates Can control up to 6 scenarios For installation in BS, Italian or US flush-mounting boxes		
1	5 739 12	○ White
1	5 739 13	● Black

Key covers for micropush control mechanisms, **p. 408**



Pack	Cat.Nos	Flush-mounting controller with built-in control
1	0 675 56	For controlling two lighting circuits or a blind motor Slat orientation control 2 outputs - 2 A 230 V power supply To be installed in flush-mounting boxes To be equipped with key covers (p. 408), support frames and plates (p. 386 to 393)
<b>Advanced rolling shutter management devices</b>		
Relay interlocking or pulse based motor drive Position status return: closed, open, intermediate position. Drive following different orders: up, down, or opening		
1	0 036 66	<b>2-relay controller for the driving of a motor</b> Maximum motor power: 500 W Logic relay interlocking 2 DIN modules 17.5 mm
1	0 675 57	<b>Controller with integrated control for the driving of a motor equipped</b> To be equipped with key covers: - shutter STOP marking Cat.Nos 5 745 45/46/47/48 - up/down symbol Cat.Nos 5 745 15/16 or 5 744 92/93 To be equipped with plate and support frame (p. 386 to 393) Maximum motor power: 500 W Logic relay interlocking Stop, up, down function Possibility of blade angle adjustment Recall of a previously saved opening/closing position Recording of the opening/closing position on the control using self-learning procedure
1	0 675 58	<b>Specific advanced motor management control</b> To be equipped with key covers: - shutter STOP marking Cat.Nos 5 745 45/46/47/48 - up/down symbol Cat.Nos 5 745 15/16 or 5 744 92/93 To be equipped with plate and support frame (p. 386 to 393) Point-point, room, group, and general control of the motor controlled rolling shutters, to be used in conjunction with actuators Cat.Nos 0 036 66 or 0 675 57 Stop, up, down function Possibility of blade angle adjustment Recall of a previously saved opening/closing position Recording of the opening/closing position on the control using self-learning procedure

Installation principle, **see e-catalogue**





Support frame and plate selection charts **p. 386-393**

Pack	Cat.Nos	Scenario controllers
1	5 739 02	For controlling a number of controllers and managing 4 scenarios To be used in conjunction with scenario module Cat.No 0 035 51 (p. 411) Supplied complete with scenario identification label Equipped with cover plates To be equipped with support frames and plates (p. 386 to 393) 2 modules ○ White ● Magnesium
1	5 739 03	
1	5 745 03	○ White ● Magnesium
1	5 745 04	

Pack	Cat.Nos	8 push-buttons control
1	0 675 92	<b>Mechanism</b> For lighting, automation, sound diffusion and scenario functions To be equipped with support frame and plates (p. 386 to 393) 2 modules
1	0 675 96	<b>A5 sheets</b> For the customisation of the symbols of Cat.No 0 675 92 ○ White ● Magnesium
1	0 675 95	

Pack	Cat.Nos	Touch screens
1	5 737 16	Used to control manually or by programming one of the following functions: - control of 4 scenarios - display and centralised management of temperature (1 zone) - sound system (display and selection of sound distribution sources - adjusting loudspeakers and setting the wake-up function) Equipped with cover plates To be equipped with support frames and plates (p. 386 to 393) ○ White ● Magnesium
1	5 737 17	

Pack	Cat.Nos	IR remote control
1	0 882 32	For remote control of equipment wired on the BUS (eg: lighting, shutters, etc.) <b>Radio/ZigBee® - IR remote control</b> For use in conjunction with infrared receiver 5-scenario controller Supplied with batteries
1	5 739 00	<b>IR receivers</b> Equipped with round version cover plates, to be equipped with support frames and plates (p. 386 to 393) Can take up to 4 control units Must be installed in the infrared remote control relay Cat.No 0 882 32 (the receiver sends the command from the remote control to the product concerned) ○ White ● Magnesium
1	5 739 01	

ZigBee®: Certified product Manufacturer Specific Profile

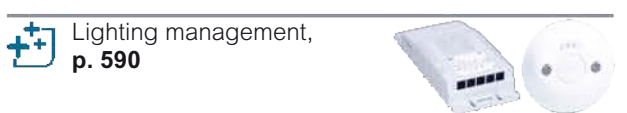

Lighting management, **p. 590**

# Arteor™

modular equipment for lighting control and automation BUS/SCS



0 036 52



0 026 02



0 035 52



0 035 51



0 035 62

Load selection charts **p. 413**  
 Technical characteristics **see e-catalogue**

Pack	Cat.Nos	Multi-application DIN controllers
		NO contact For lighting and motors 2 DIN modules 17.5 mm
1	0 038 41	1 output 16 A
1	0 038 42	2 outputs 10 A
1	0 038 44	4 output 6 A - common phase
		<b>DIN controllers for dimming</b> For use in conjunction with loads and control mechanisms (p. 408) for dimming control <b>For incandescent, halogen and ferromagnetic loads</b> Load: 60 - 1000 W / 230 V - 50 Hz 4 DIN modules 17.5 mm
1	0 036 52	<b>For electronic transformers loads</b> 1 output
1	0 036 53	Load: 60 - 400 VA / 230 V - 50 Hz 4 DIN modules 17.5 mm
1	0 036 65	<b>For dimmable LEDs and CFL (Compact Fluorescent Lamps) incandescent, halogen lamps and electronic transformers</b> 1 output Load: 1 - 300 VA / 230 V or 1 - 150 VA / 127 V 4 DIN modules 17.5 mm
1	0 026 27	6 outputs - 12 DIN modules 17.5 mm - 300 VA per output - 230 V - Not CE marked
1	0 036 56	<b>For 1-10 V ballasts</b> Load: 500 VA maximum 2 DIN modules 17.5 mm
1	0 026 11	1 output - 1000 VA maximum 6 DIN modules 17.5 mm
1	0 026 31	<b>For DALI protocol</b> Enables communication between the BUS/SCS installation and the lighting appliances controlled by DALI protocol 6 DIN modules 17.5 mm
		<b>For incandescent, halogen 230 V, ELV halogen with electronic or ferromagnetic transformer</b> 6 DIN modules 17.5 mm Automatic recognition of the load
1	0 026 21	1 output - 1000 W maximum
1	0 026 22	2 outputs - 400 W maximum per output
		<b>DIN on/off lighting controllers</b>
1	0 026 01	For lighting (commercial sector) 2 outputs 16 A 4 DIN modules 17.5 mm
1	0 026 02	4 outputs 16 A 6 DIN modules 17.5 mm

Pack	Cat.Nos	BUS power supplies
		<b>27 V<sub>DC</sub> - 1.2 A</b> Maximum consumption: 300 mA Maximum current supplied: 1.2 A 8 DIN modules 17.5 mm
1	0 035 60	Input voltage: 230 VA output voltage 27 V <sub>DC</sub>
1	5 739 97	Input voltage: 127 VA output voltage 27 V <sub>DC</sub>
		<b>27 V<sub>DC</sub> - 0.6 A</b> Maximum current supplied: 0.6 A 2 DIN modules 17.5 mm
1	0 035 67	Input voltage: 230 VA output voltage 27 V <sub>DC</sub>
		<b>RJ adaptor</b> For connecting Cat.Nos 0 026 01/02/21/22/11 to the BUS
10	0 488 72	Male connector
		<b>Contact interfaces</b> Allow the connection between traditional wiring devices such as switches, time delay switches or external sensors 2 independent contacts
1	0 035 53	2 DIN modules 17.5 mm
1	5 739 96	Basic modularity to be installed in flush-mounting box
		<b>Additional DIN devices</b>
1	0 035 52	<b>Memory module for actuators</b> Restore the last state of an actuator in case of a power failure 2 DIN modules 17.5 mm
1	0 035 51	<b>Scenario module</b> Allows creation of scenarios by linking different functions. Up to 16 scenarios 2 DIN modules 17.5 mm
1	0 035 62	<b>SCS-SCS gateway (extension)</b> Allows the extension of the installation or the integration between different functions Suitable for larger installations 2 DIN modules 17.5 mm

Installation principle,  
 see e-catalogue



 0 488 23  
(directional head)

5 740 48



0 492 13



0 492 19



0 261 45

Pack	Cat.Nos	180° corner sensors
1	0 488 24	<p>Check presence and light level continuously, switch off when there is sufficient natural light Automatic switch-on/off (factory setting) Precise on-site adjustment using configuration tool (p. 596) Connect to controllers by cord or RJ 45 cable or BUS/SCS cable to be fitted with RJ 45 connector Cat.No 0 488 72 (p. 596)</p> <p><b>PIR technology wall/surface-mounting lighting management sensor, 180°</b> With directional head, range (front) 5 m IP 42 Consumption: 0.2 W on standby Supplied with fixing plate</p>
1	0 488 23	<p><b>Dual technology wall/surface-mounting lighting management sensor, 180°</b> Infrared and ultrasonic detection with directional head, range (front) 7 m Consumption: 0.5 W on standby Supplied with fixing plate</p>

Pack	Cat.Nos	180° switch sensors
1	5 740 46	<p><b>PIR technology wall, flush-mounting lighting management sensors, 180°</b> Range 8 m Recommended fixing height: 1.2 m IP 41 Consumption: 0.2 W on standby Integrated push-button For installation in box, depth 40 mm min., or in surface-mounting box Cat.No 5 723 90 2 modules</p> <p>○ White ● Magnesium</p>
1	5 740 96	
1	5 740 48	<p><b>Dual technology wall, flush-mounting lighting management sensors, 180°</b> Infrared and ultrasonic detection, range 8 m Recommended fixing height: 1.2 m IP 41 Consumption: 0.2 W on standby Integrated push-button For installation in box, depth 40 mm min., or in surface-mounting box Cat.No 5 723 90 2 modules</p> <p>○ White ● Magnesium</p>
1	5 740 98	

Pack	Cat.Nos	BUS/SCS cables
1	0 492 31	Conform to IEC 45-5 and IEC 20-20 Grey Length 100 m
1	0 492 32	Length 500 m
1	0 492 74	Length 1000 m - Supplied on wooden reels
10	0 492 22	<b>BUS spare clamp</b> Used to connect the various system components (controls, dimmers, etc) to the BUS line Male connector
1	0 492 34	<b>USB cable</b> Programming cable
10	0 492 00	<b>Plug-in jumpers</b> Used to associate an address with the different system components
10	0 492 01	
10	0 492 02	
10	0 492 03	
10	0 492 04	
1	0 492 05	
1	0 492 06	
10	0 492 07	
10	0 492 08	
10	0 492 09	
5	0 492 10	
5	0 492 11	
5	0 492 12	
5	0 492 13	
5	0 492 14	
5	0 492 15	
5	0 492 16	
5	0 492 17	
5	0 492 18	
5	0 492 19	
5	0 492 20	
5	0 492 21	
1	0 492 37	Kit with: AUX, GEN, GR, AMB, ON, OFF, O/I, PUL, SLA, CEN, ↑↓, ↑↓M (10 pieces of each figure)
1	0 261 45	Kit with «0 to 9» jumpers (10 of each number)
1	0 492 65	Plier for plug-in jumpers
1	0 883 97	<b>Virtual configuration software</b> Used to configure mechanisms and controllers in the installation for applications such as lighting, shutters and temperature control For use in conjunction with TCP-IP web server (p. 421) Comprising: 1 CD with software for PC



**Actuators and dimmers max. loads at 230 V**

		Universal								
		Leading edge			Trailing edge					
Cat.Nos		Incandescent lamp	Halogen lamp	ELV halogen with ferromagnetic transformer	ELV halogen with electronic transformer	Fluorescent tube	Compact fluorescent lamp	LED	Fluorescent lamps with 0-10 V ballast	Reducer motor for shutter
ACTUATORS	0 038 41	10 A - 2300 W	10 A - 2300 W	4 A - cos φ 0.5 920 VA	4 A - 920 VA	920 W	500 VA 10 lamps max.	500 W 10 lamps max.	-	-
	0 038 42	6A - 1380 W	6A - 1380 W	2 A - cos φ 0.5 460 VA	1 A - 230 VA	230 W	250 VA 4 lamps max.	250 W 4 lamps max.	-	2 A - 460 W
	0 038 44	2A - 460 W	2A - 460 W	2 A - cos φ 0.5 460 VA	0.3 A - 70 VA	70 W	70 VA 2 lamps max.	70 W 2 lamps max.	-	2 A - 460 W
	0 026 01	2 x 3600 W	2 x 3600 W	2 x 3600 VA	2 x 3600 VA	2 x 1000 VA	2 x 1000 VA	-	-	-
	0 026 02	4 x 1000 W	4 x 1000 W	4 x 500 VA	4 x 500 VA	4 x 500 VA	4 x 500 VA	4 x 500 VA	-	4 x 100 VA
DIMMERS	0 036 56	-	-	-	-	-	-	-	460 W - max. 10 ballast type T5, T8, compact or driver for LED	-
	0 026 11	-	-	-	-	-	-	-	1000 VA - 50 mA	-
	0 026 21	1000 W	1000 W	1000 VA	1000 VA	-	-	-	-	-
	0 026 22	2 x 400 W	2 x 400 W	2 x 400 VA	2 x 400 VA	-	-	-	-	-
	0 036 52	0,25 - 4,3 A 60 - 1000 W	0,25 - 4,3 A 60 - 1000 W	0,25 - 4,3 A 60 - 1000 VA	-	-	-	-	-	-
	0 036 53	-	-	-	0,25 - 1,7 A 60 - 400 VA	-	-	-	-	-
	0 036 65	1 ÷ 300 W	1 ÷ 300 W	-	1 ÷ 300 VA	-	1 ÷ 300 VA	1 ÷ 300 VA	-	-
	0 026 27	5 - 300 W	5 - 300 W	5 - 300 W	5 - 300 W	-	5 - 300 W	5 - 300 W	-	-

**Actuators and dimmers max. loads at 110 V**

		Universal								
		Leading edge			Trailing edge					
Cat.Nos		Incandescent lamp	Halogen lamp	ELV halogen with ferromagnetic transformer	ELV halogen with electronic transformer	Fluorescent tube	Compact fluorescent lamp	LED	Fluorescent lamps with 0-10 V ballast	Reducer motor for shutter
ACTUATORS	0 038 41	1100 W	1100 W	500 VA	440 W	500 VA	250 W 10 lamps max.	250 W 10 lamps max.	-	-
	0 038 42	660 W	660 W	250 VA	110 W	125 VA	120 W 4 lamps max.	120 W 4 lamps max.	-	250 W
	0 038 44	220 W	220 W	250 VA	35 W	35 VA	35 W 2 lamps max.	35 W 2 lamps max.	-	250 W
	0 026 00	1800 W	1800 W	1800 VA	1800 VA	500 VA	500 VA	-	-	-
	0 026 01	2 x 1800 W	2 x 1800 W	2 x 1800 VA	2 x 1800 VA	2 x 500 VA	2 x 500 VA	-	-	-
	0 026 02	4 x 500 W	4 x 500 W	4 x 250 VA	4 x 250 VA	4 x 250 VA	4 x 250 VA	4 x 250 VA	-	4 x 50 VA
DIMMERS	0 036 56	-	-	-	-	-	-	-	220 W - max. 10 ballast type T5, T8, compact or driver for LED	-
	0 026 11	-	-	-	-	-	-	-	500 VA - 50 mA	-
	0 026 21	500 W	500 W	500 VA	500 VA	-	-	-	-	-
	0 026 22	2 x 200 W	2 x 200 W	2 x 200 VA	2 x 200 VA	-	-	-	-	-
	0 036 52	0,25 - 3,5 A 60 - 800 W	0,25 - 3,5 A 60 - 800 W	0,25 - 2,5 A 60 - 800 VA	-	-	-	-	-	-
	0 036 53	-	-	-	-	-	-	-	-	-
	0 036 65	1 ÷ 300 W	1 ÷ 300 W	-	1 ÷ 300 VA	-	1 ÷ 300 VA	1 ÷ 300 VA	-	-





5 739 19



5 739 20



5 739 23



5 739 24



5 737 17

Support frame and plate selection charts **p. 386-393**  
 Technical characteristics **see e-catalogue**

Pack	Cat.Nos	Central units for temperature control
1	5 739 18	Equipped with square version keypad cover plates To be equipped with special plates (p. 390, 391) Supplied with flush-mounting box and 7.2 V battery Cat.No 0 675 18 Can manage up to 99 zones Can manage up to 99 zones ○ White ● Magnesium
1	5 739 19	
1	0 674 59 <b>N</b>	<b>Display thermostat</b> Flush mounted thermostat with backlit display Can be used to control the temperature of an individual zone, both if a temperature central unit is and is not present It features a temperature probe and an input for the connection of a contact line (e.g. window contact) Can be used for the management of different types of systems, and the adjustment of the fan speed when fan coils are used Possibility of automatic operation (summer/winter), with compatible systems Equipped with square version cover plates To be equipped with support frame and plates (p. 386 to 393) To be installed in flush-mounting boxes 2 modules

Pack	Cat.Nos	Probes
1	5 739 20	To control the room temperature of heating and cooling system Equipped with square version cover plates To be equipped with support frame and plates (p. 386 to 393) To be installed in flush-mounting boxes 2 modules <b>Standard</b> Temperature setting range: from 3 °C to 40 °C ○ White ● Magnesium
1	5 739 21	
1	5 739 22	<b>With knob</b> Temperature setting range: from 3 °C to 40 °C with knob for adjustment of +/- 3 °C relative to the set temperature and for the modality selection ○ White ● Magnesium
1	5 739 23	
1	5 739 24	<b>With manual/automatic speed selection for fan coil</b> Temperature setting range: from 3 °C to 40 °C with manual/automatic speed selection for fan-coil ○ White ● Magnesium
1	5 739 25	
1	5 737 16 <b>N</b>	<b>Touch screens</b> Used to control manually or by programming one of the following functions: control of 4 scenarios, display and centralised management of temperature (1 zone), sound system (display and selection of sound distribution sources, adjusting loudspeakers and setting the wake-up function) Equipped with cover plates, to be equipped with support frames and plates (p. 386 to 393) ○ White ● Magnesium
1	5 737 17	





# Arteor™

## temperature control BUS/SCS (continued)



0 035 79



0 035 80



0 883 01

Technical characteristics **see e-catalogue**

Pack	Cat.Nos	DIN rail actuators 100/240 VA - 50/60 Hz
1	0 035 79	<b>Actuator with 2 independent relays</b> For single and double loads: 6 A resistive, 3 A motorised valves and pumps 2 DIN modules 17.5 mm
1	0 035 80	<b>Actuator with 4 independent relays</b> For single, double or mixed loads: 6 A resistive, 3 A motorised valves, pumps and fan-coils 2 DIN modules 17.5 mm
1	<b>N</b> 0 035 17	<b>DIN actuators for the control of ON/OFF valves, motorised valves, pumps and fan coils with 0-10V proportional valves</b> Actuator with 8 independent relays for the control of on-off valves, motorised valves (open-close and three-point valves), pumps and fan coils with 2 and 4 tubes 4 A resistive, 1 A motorised valves, pumps and fan coils 4 DIN modules 17.5 mm
1	0 035 19	Actuator with 3 independent relays and 2 x 0-10 Volt outputs for the control of fan coils with 2 and 4 tubes with 0-10 Volt proportional valves 4 A resistive, 1 A fan coils 4 DIN modules 17.5 mm
1	0 035 18	Actuator with 2 x 0-10 Volt outputs for the control of 0-10 V proportional valves 2 DIN modules 17.5 mm
1		<b>BUS power supplies</b> <b>27 V<sub>DC</sub> - 1.2 A</b> Maximum consumption: 300 mA Maximum current supplied: 1.2 A 8 DIN modules 17.5 mm 1 0 035 60 Input voltage: 230 VA output voltage 27 V <sub>DC</sub> 1 5 739 97 Input voltage: 127 VA output voltage 27 V <sub>DC</sub>
1	0 035 67	<b>27 V<sub>DC</sub> - 0.6 A</b> Maximum current supplied: 0.6 A 2 DIN modules 17.5 mm Input voltage: 230 VA output voltage 27 V <sub>DC</sub>
1	0 675 18	<b>Battery for temperature control central unit</b> 7.2 V battery for central unit

Pack	Cat.Nos	SCS cables
1	0 492 31	Conform to IEC 45-5 and IEC 20-20 Grey Length 100 m
1	0 492 32	Length 500 m
1	<b>N</b> 0 492 74	Length 1000 m - Supplied on wooden reels
1	0 883 01	<b>IR transmitter for splitter</b> For controlling splitters in different modes (auto-hot-cold) Management of On/Off speeds (auto-low-medium or high) Temperature range between 16 °C and 30 °C Air conditioning remote control can "learn" the IR signal Can be installed behind the air conditioning unit. Supplied complete with 2 m cable



5 739 34



5 739 38



5 739 41



5 739 44



5 739 48

Support frame and plate selection charts **p. 386-393**  
 Technical characteristics **see e-catalogue**

Pack	Cat.Nos	Central units for intruder alarm
1	5 739 34	Equipped with square version keypad cover plates To be equipped with special plates (p. 390, 391) Supplied with flush-mounting box Central unit with PSTN integrated telephone dialing device Allows manual activation/deactivation up of the system Can manage up to 72 detectors <input type="radio"/> White <input checked="" type="radio"/> Magnesium
1	5 739 35	



Pack	Cat.Nos	Detectors
1	5 739 36	<b>Fixed IR detectors</b> Volumetric presence detector with passive infrared rays Alarm signal LED with memory 8 meters range, 14 bands divided over 3 levels Possible activation of auxiliary prealarm channel Angular opening 105° <input type="radio"/> White <input checked="" type="radio"/> Magnesium
1	5 739 37	
1	5 739 38	<b>Adjustable IR detectors</b> Volumetric presence detector with passive infrared rays Alarm signal LED with memory 8 meters range, 14 bands divided over 3 levels Possible activation of auxiliary prealarm channel Angular opening can be divided from 105° to 0° Swivel lens on 2 axes <input type="radio"/> White <input checked="" type="radio"/> Magnesium
1	5 739 39	
1	5 739 40	<b>Double technology detectors (IR and MW)</b> Volumetric presence detector made up of two sensors: one infrared to detect hot bodies (IR) and one with microwaves to detect movements (MW) The alarm is only triggered when both detection technologies are activated <input type="radio"/> White <input checked="" type="radio"/> Magnesium
1	5 739 41	



Pack	Cat.Nos	Relay actuator modules
1	0 035 91	With multiple configuration with output via relay-contacts NO/NC, 24 V 0.4 A cos φ 0.4 To be used to repeat the alarm, activate an external device, repeat the system state and signal when battery is flat 2 DIN modules 17.5 mm Can be installed in a flush-mounting box depth 50 mm behind a wiring accessory or a blanking plate
1	0 883 91	
1	5 739 44	<b>Keypads</b> Equipped with square version cover plates <b>Alarm keypads</b> Activation/deactivation via numeric code 2 modules To be equipped with support frames and plates (p. 386 to 393) <input type="radio"/> White <input checked="" type="radio"/> Magnesium
1	5 739 45	
1	5 739 46	<b>Display keypads</b> Activation/deactivation keypad via numeric code Allow the visualization of information and manage other functions such as independent management of zones To be equipped with special plates (p. 390, 391) Supplied with flush-mounting box and battery 7.2 V Cat.No 0 675 18 <input type="radio"/> White <input checked="" type="radio"/> Magnesium
1	5 739 47	
1	5 739 48	<b>Transponder readers</b> Equipped with square version cover plates To be equipped with support frames and plates (p. 386 to 393) To be installed in flush-mounting boxes 2 modules Transponder reader which activate/deactivate the system with the transponder (badge) Able to store up to 30 transponders <input type="radio"/> White <input checked="" type="radio"/> Magnesium
1	5 739 49	
3	0 035 75	<b>Transponders</b> Key card transponder to activate/deactivate the system Proximity card, 125 kHz technology, used to activate/deactivate the alarm. Supplied complete with label
5	0 675 17	



# Arteor™

## intruder alarm BUS/SCS (continued)



5 739 84



0 675 13



0 431 00

Technical characteristics **see e-catalogue**

Pack	Cat.Nos	Sounders	Pack	Cat.Nos	Peripheral opening detectors
1	5 739 84	<b>Indoor sounder</b> Can be installed in flush-mounting box Cat.Nos 0 893 79 and 0 892 79 To be equipped with 6 V battery Cat.No 0 675 16 Sound intensity 90 dB(A) at 3 meters Protected against pulling off and tamperproof	10	0 431 00	For use in conjunction with interface Cat.No 0 675 13 or 0 035 73 <b>Magnetic opening detectors</b> Surface-mounting magnetic detector 1 spring blade switch to be fixed on the door frame 1 moving magnet to be fixed on the door leaf For use with mini-trunking 20 x 12.5 mm Cat.No 0 300 08
1	0 844 24	<b>Outdoor sounder</b> Self-powered, self-protected against opening Emits a loud noise: 100 dB at 1 m Flashing light: 30 flashes a minute Use battery Cat.No 0 433 41 (fitted inside the siren)	10	0 431 01	Flush-mounting magnetic detector For surveillance of non-magnetic doors Dimens.: ø8 mm - length: 30 mm
		<b>Accessories</b>	1	0 431 08	Magnetic detector for garage door 1 foot to be fixed on the floor 1 magnet to be fixed on the door Supplied with 1 connection cable with steel casing
1	0 675 16	<b>Batteries</b>	1	0 431 10	<b>Glass break detector</b> Detection over a radius of 1.5 m Ultrasound detection created by the glass breaking Glued on the door (adhesive supplied)
1	0 675 18	6 V - 0.55 Ah for indoor siren	1	0 431 12	<b>Tread mat</b> Placed under object to be protected or under carpet and mat placed on the access path
1	0 407 49	7.2 V battery for central unit			<b>Detection device for use in conjunction with interface Cat.No 0 675 13</b>
1	0 407 49	Lead battery 12 V - 7 Ah	1	0 675 14	<b>Flood sensor</b> In conjunction with a switch for local acknowledgement
1	0 634 36	<b>Power supply</b> For installation in the consumer unit, self-protected against opening of the cabinet Output current: 1 A Output voltage: 24.5 V= 8 DIN modules 17.5 mm			
1	6 831 59	<b>SCS cable for intruder alarm</b> Supplied on a reel - Red Length 100 m			
10	0 035 72	<b>Tamper-proof device</b> Rod for self-monitoring against pulling off			
2	0 893 79	<b>Flush-mounting boxes</b>			
2	0 892 79	For dry partitions - 2 x 3 modules For concrete walls - 2 x 3 modules			
		<b>Opening detector interfaces</b>			
		Allow other brands sensors management through N/C contacts			
1	0 675 13	<b>Opening detector interfaces</b> Can be installed in a flush-mounting box Depth 50 mm behind a wiring accessory or a blanking plate			
1	0 035 73	2 DIN modules 17.5 mm			
1	0 883 02	<b>12 V opening detectors interfaces</b> Can be installed in a flush-mounting box Depth 50 mm behind a wiring accessory or a blanking plate			
1	0 035 71	2 DIN modules 17.5 mm			

Installation principle, **see e-catalogue**





Support frame and plate selection charts **p. 386-393**  
 Technical characteristics **see e-catalogue**

Pack	Cat.Nos	Flush-mounting amplifiers
1	<b>N</b> 0 675 55	<b>2 x 1 Wrms - 2 modules</b> To be equipped with key covers (p. 410), support frame and plate (p. 386 to 393) 
5	5 745 11	<b>Key covers - 1 module</b> For flush-mounting amplifier Cat.No 0 675 55
5	5 745 12	
5	5 745 05	○ White - right-hand side mounting ● Magnesium - right-hand side mounting
5	5 745 06	
5	5 744 91	○ White - left-hand side mounting ● Magnesium - left-hand side mounting
5	5 744 90	
5	5 744 87	○ White ● Magnesium
5	5 744 86	
1	0 035 85	<b>DIN rail amplifiers</b> <b>2 x 1 Wrms</b> 2 x 1 Wrms - 100/240 VA 4 DIN modules 17.5 mm
1	0 035 83	<b>2 x 30 Wrms</b> 2 x 30 Wrms - 100/240 VA 10 DIN modules 17.5 mm
1	5 739 26	<b>RCA inputs</b> Equipped with square version cover plates To be equipped with support frames and plates (p. 386 to 393) For connecting a stereo source to the system 2 modules 
1	5 739 27	

Pack	Cat.Nos	Flush-mounting loudspeakers
1	5 739 28	<b>8 ohms - 100 W - 50 Wrms</b> To be installed in flush-mounting box min. depth 80 mm  ○ White ● Magnesium
1	5 739 29	
1	5 739 77	<b>16 ohms - 12 W - 6 Wrms</b> To be installed in flush-mounting box Cat.Nos 0 893 79 or 0 892 79  ○ White
1	5 739 30	<b>Surface-mounting loudspeakers</b>  8 ohms - 40 W - 20 Wrms 8 ohms - 140 W - 70 Wrms
1	5 739 78	
1	5 739 81	<b>False ceiling loudspeakers</b>  8 ohms - 100 W - 50 Wrms Ø240 mm
1	5 739 82	 8 ohms - 20 W - 10 Wrms Ø100 mm
1	<b>N</b> 5 737 16	<b>Touch screens</b> Used to control manually or by programming one of the following functions: control of 4 scenarios, display and centralised management of temperature (1 zone), sound system (display and selection of sound distribution sources, adjusting loudspeakers and setting the wake-up function) Equipped with cover plates To be equipped with support frames and plates (p. 386 to 393)  ○ White ● Magnesium
1	5 737 17	
2	0 893 79	<b>Flush-mounting boxes</b> For loudspeaker Cat.No 5 739 77 For dry partitions - 2 x 3 modules
2	0 892 79	

Installation principle,  
**see e-catalogue**



# Arteor™

## sound diffusion BUS/SCS (continued)











Technical characteristics **see e-catalogue**

Pack	Cat.Nos	Connectors	Pack	Cat.Nos	Sound output
1	5 739 32	Equipped with square version cover plates To be equipped with support frames and plates (p. 386 to 393) 8 contact connector to link interface Cat.No 0 035 86 to the BUS 1 module White Magnesium	1	5 740 44	Sound output for touch screen 3.5" (p. 421) Works as a source for sound diffusion system
1	5 739 33		1	0 035 89	<b>Attenuator</b> To be connected at the end of the line of the outputs of audio/video node and multi-channel matrix
1	0 035 84	<b>Audio/video signal distribution devices</b> Multi-channel matrix with cross-connection, mixing switch functions for distribution of: the stereo sound source signal and audio/video signals 8 inputs (first 4 for the 2-wire audio/video system and others for stereo sound source) 8 outputs 10 DIN modules 17.5 mm	1	5 739 88	<b>Insulator for sound sources</b> Isolates the 27 V sound system from 230 V external sources For use with RCA input
1	5 739 98	<b>Audio/video node for mixing audio/video sources (max. 4 sources)</b> 6 DIN modules 17.5 mm	1	0 634 35	<b>Power supplies</b> Power supply unit for sound system Input voltage: 230 VA output voltage 27 V= Maximum consumption 1 A 8 DIN modules 17.5 mm
1	0 035 82	<b>DIN RDS radio source</b> RDS stereo radio tuner with coaxial connector for external aerial antenna Supplied with depth compensator for DIN rail 4 DIN modules 17.5 mm	1	5 739 90	<b>Power supply unit for sound system</b> Input voltage: 127 VA output voltage 27 V= Maximum consumption 1 A 8 DIN modules 17.5 mm
1	0 035 86	<b>DIN stereo control source</b> For stereo sources IR remote control possible RCA/RCA and jack cables to connect to IR transmitters 4 DIN modules 17.5 mm	1	5 739 99	<b>BUS cable</b> For sound diffusion and video door entry system 200 m
			5	5 740 45	<b>BUS cord</b> 600 mm

Installation principle,  
**see e-catalogue**





Pack	Cat.Nos	Consumption indicators	Pack	Cat.Nos	Load and load shedding management
1	0 035 54	<b>Pulse counter interface</b>  <p>Used to store data from a pulse counter (water, colorimetry, heat or gas)            In countries where there is ATEX Directive it's mandatory to use a zener barrier/Galvanic insulation barrier between the pulse counter interface and the gas meter            The barrier must answer to the ATEX directive and must be installed outside ATEX area            Install one pulse counter interface per meter to measure the consumption individually            Consumption data stored hour by hour, and kept for several years (12 years)            Display can be in the form of histograms or statistical data            Use a touch screen Cat.Nos 5 739 58 or 0 672 67/68 to display the consumption of the various meters</p>	1	0 035 57	<b>Central control unit</b>  <p>Used to define an energy threshold and manage load shedding priorities set on controllers to avoid unwanted breaks as a result of exceeding the energy contract            Manages up to 63 controllers            The max. authorised power threshold can be defined            The settings can be activated/deactivated from the touch screen            Instantaneous and cumulative display of circuit consumption on the touch screen            Integrated memory module            For installation in the consumer unit            1 DIN module 17.5 mm</p>
1	0 035 55	<b>Consumption indicator for 3 circuits</b>  <p>For single phase installations            Supplied with a toroid and its link            Each toroid can monitor one circuit            The consumption indicator can take up to 3 toroids, for monitoring 3 separate circuits            Several consumption indicators can be installed to monitor more than 3 circuits on the installation.            Instantaneous and cumulative display of the consumption for each circuit and display of consumption on touch screens Cat.Nos 5 739 58 or 0 672 67/68            Display can be in the form of histograms or statistical data. Consumption data can be stored for 1 year, hour by hour, 2 years day by day or 12 years month by month</p>	1	5 739 85	<b>Control with load monitoring</b> Equipped with square version cover plates To be equipped with support frames and plates (p. 386 to p. 393) Used to display the status of the load controlled by the central load control unit (Cat.No 0 035 57) and force operation of the load independently Used to force the load during normal operation and reactivate the load previously deactivated by the central control unit ○ White ● Magnesium
1	0 035 56	<b>Additional toroid</b>  <p>Operates with consumption indicator Cat.No 0 035 55            Also operates with controller Cat.No 0 035 58 for load diagnostics 90 A max.            Cable cross-section 25 mm<sup>2</sup> max</p>	1	0 035 59	<b>16 A controller</b>  <p>Used to define a priority level for a circuit in the context of a load shedding function            For installation in the consumer unit            1 DIN module 17.5 mm            Can be used as an electronic control box controller and/or an energy management controller</p>
1	0 035 66	<b>IP data concentrator</b>  <p>Used to display the data measured by the system via several web pages            Can handle different billing rates            Integrated memory for up to 10 pulse counter circuits            Centralises the data from circuits/pulse counter            Automatic backup onto SD card</p>	1	0 035 58	<b>16 A controller with consumption measurement</b>  <p>Used to define a priority level for a circuit in the context of a load shedding function            For installation in the consumer unit            1 DIN module 17.5 mm            Can be used as an electronic control box controller and/or an energy management controller            Measures the consumption of the load being controlled and displays (via touch screen Cat.Nos 5 739 58 or 0 672 67/68) instantaneous and cumulative consumption with separate reset - Diagnostics of the load being controlled with use of toroid Cat.No 0 035 56</p>
10	0 492 44	<b>Connectors</b>  <p>Spare parts for consumption indicator Cat.No 0 035 55 and controllers Cat.Nos 0 035 57/58/59</p>	1	0 672 05	<b>Energy display</b>  <p>1,6" basic display for visualizing consumption of different lines (datacoming from Cat.Nos 0 035 55/57/54) and/or for controlling actuators belonging to load management system (Cat.Nos 0 035 58/59)            2 modules</p>
10	0 492 45	2-pole connector			
10	0 492 46	3-pole connector			

# Arteor™

## home system management BUS/SCS



Support frame and plate selection charts **p. 386-393**

Pack	Cat.Nos	Local management
1	5 737 16	<b>Local display 1.2"</b> 1.2" OLED touch screen for the management of max. 4 of following functions: sound system, temperature control, scenarios, energy consumptions visualization and load management 2 modules Equipped with cover plates, to be equipped with support frames and plates (p. 386 to 393) <input type="radio"/> White <input type="radio"/> Magnesium
1	5 737 17	
1	5 739 58	<b>MyHome screen 3.5"</b> 3.5" colour touch screen for the management of light functions, automation, burglar alarm, temperature control, sound system, scenarios and energy management Equipped with front panel USB connector for setup and ready for Open Webnet programming language To be installed in flush-mounting box Cat.Nos 0 892 79 or 0 893 79 Equipped with surround, to be equipped with special plates (p. 390-391)
1	0 672 68	<b>MyHome screen 10"</b> 16/9 10" LCD touch screen used for: - management of MyHome and video door entry system - management of multimedia contents (Ethernet, USB, SD card) and web browser - management of customised profiles Navigation by rooms Possibility of customizing background images Wall-mounting installation Supplied complete with plates Requires power supply unit Cat.No 0 634 42 <input type="radio"/> White <input type="radio"/> Black
1	0 672 67	

Pack	Cat.Nos	Remote management
1	0 035 98	<b>Web server gateway TCP-IP</b> Audio/video web Server for the remote control of the system The device can operate as a gateway for the use of MyHome Suite 6 DIN modules 17.5 mm
1	0 492 49	<b>Other devices</b> <b>Supervision software</b> Can be used in order to tune up the system's functions through a computer, and to follow them on real time basis
1	0 035 65	<b>Scenario scheduler</b> Allows setting up of up to 300 scenarios with pre-set conditions (time and logical type) 6 DIN modules 17.5 mm
1	0 634 42	<b>Additional power supply</b> Provides power for Web server and scenario scheduler Cat.No 0 035 65 2 DIN modules 17.5 mm
1	0 035 97	<b>Open/Bacnet Gateway</b> Interface for the remote control with Touch Screen of devices Bacnet as Fancoil units, AC units, underfloor heating
2	0 893 79	<b>Flush-mounting boxes</b> For 3.5 touch screen Cat.No 5 739 58 For dry partitions - 2 x 3 modules For concrete walls - 2 x 3 modules
2	0 892 79	

Video of MyHome multimedia touch screen 10"





5 739 50



5 739 52

Support frame and plate selection charts **p. 386-393**  
 Technical characteristics **see e-catalogue**

Pack	Cat.Nos	Video internal display units
1	5 739 50	Hands-free internal unit. 2.5" LCD colour display Possible integration in BUS system. Equipped with White or Magnesium cover plates, to be equipped with special plates (p. 390-391). To be installed in flush-mounting box Cat.Nos 0 893 79 or 0 892 79
1	5 739 51	

White  
 Magnesium

Pack	Cat.Nos	Audio internal display units
1	5 740 11 <sup>1</sup>	Equipped with: - microphone - loudspeaker - 2 hang-up push-buttons - 1 door release push-button - 2 auxiliary push-buttons for other functions Volume adjustment for communication and call tone, and with bell cut-off indicator. Allows intercom between several rooms. Supplied complete with special flush-mounting box, cover plate and plate
1	5 743 11 <sup>2</sup>	

White  
 Magnesium

Pack	Cat.Nos	Optional cameras
1	5 739 52	2-wire colour camera with swiveling lens Automatic adjustment of focus and brightness Built-in microphone. Equipped with cover plates, to be equipped with support frames and plates (p. 386 to 393) To be installed in flush-mounting box 2 modules
1	5 739 53	

White  
 Magnesium

Pack	Cat.Nos	Power supplies
1	0 634 35	Power supply unit for sound system Input voltage: 230 VA output voltage 27 V <sub>DC</sub> Maximum consumption 1 A 8 DIN modules 17.5 mm
1	5 739 90	Power supply unit for sound system Input voltage: 127 VA output voltage 27 V <sub>DC</sub> Maximum consumption 1 A 8 DIN modules 17.5 mm

Pack	Cat.Nos	Flush-mounting boxes
2	0 893 79	For video display unit Cat.Nos 5 739 50/51
2	0 892 79	For dry partitions - 2 x 3 modules For concrete walls - 2 x 3 modules

1 : Supplied with White plate  
 2 : Supplied with Mirror Black plate

**Dimensions of video internal display units Cat.Nos 5 739 50/51**

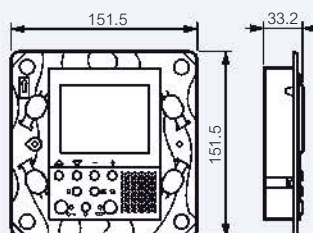

**Installation distances for video door entry systems**

	Video internal unit	Power supply	Street panel
> 0.2 mm <sup>2</sup>		50 m	50 m
		50 m (total max. distance)	
PT278 (28 mm <sup>2</sup> )		90 m	115 m
		150 m (total max. distance)	
SYT 6/10-SYT 5/10 (0,5 mm <sup>2</sup> )		60 m	80 m
		140 m (total max. distance)	
SYT 9/10-SYT 8/10 (1 mm <sup>2</sup> )		200 m	200 m
		200 m (total max. distance)	

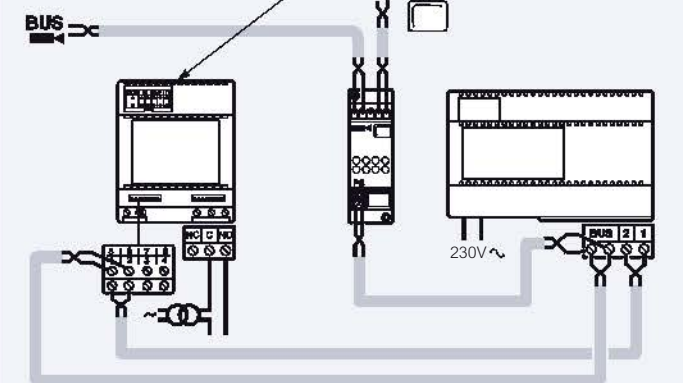
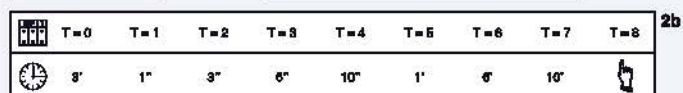

**Dimensions of audio internal units Cat.Nos 5 740 11 and 5 743 11**

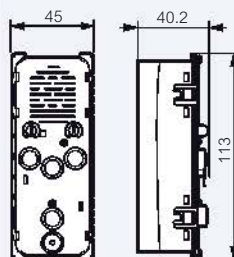

**Installation distances for audio door entry systems**

	Audio internal unit	Power supply	Street panel	Door release
0.28 mm <sup>2</sup>	140 m	200 m	30 m	
	340 m			
0.50 mm <sup>2</sup>	210 m	290 m	50 m	
	500 m			
1 mm <sup>2</sup>	420 m	580 m	100 m	
	1000 m			

Wiring diagram,  
 see e-catalogue







# 3 systems to create your Home Network

Compose your system to your specifications to distribute in the home: phone, data, Internet on RJ45, and TV over coaxial  
This multimedia modular system fits in any DIN cabinet (easy plug)

## DISCOVER THE 3 SYSTEMS

- **Classic** : TV-R-SAT + RJ 45 sockets + modular equipment. Affectionation of each RJ45 socket to different applications
- **Evolutione** : TV-R-SAT + RJ 45 sockets + modular equipment. Automatic distribution and recognition of telephone, Internet, data and IPTV
- **Evolutione +** : RJ 45 sockets + modular equipment. Automatic distribution and recognition of telephone, Internet, data and IPTV



Classic Home Network



Evolutione Home Network



Evolutione + Home Network

## RJ 45 PATCH MODULES, CABLES, CORDS AND MODULAR EQUIPMENT

- Using RJ 45 patch modules ensures good connections along time and reduces maintenance
- Modular equipment for incoming telephone, IP television and internet, ADSL and distribution



RJ 45 patch modules



Cables and cords



Modular equipment

## Classic home network

create your enclosure

RJ 45 SOCKETS		Numbers of modules	Cat.Nos	Qty to order		
	Arteor RJ 45 sockets - UTP	White	2	5 723 14	<input type="text"/>	
		Magnesium	2	5 728 14	<input type="text"/>	
TV-R-SAT SOCKETS						
	Arteor TV-R-SAT socket	White	2	5 721 72	<input type="text"/>	
		Magnesium	2	5 726 72	<input type="text"/>	
PATCH EQUIPMENT						
	RJ 45 Modular DIN patch module - UTP		1	4 130 01	<input type="text"/>	
	Flexible patch cord - 0.2 m	+	-	4 130 47	<input type="text"/>	
	Flexible patch cord - 0.4 m	or	-	4 130 48	<input type="text"/>	
EQUIPMENT FOR INCOMING TELEPHONE, TELEVISION, ADSL, AND DISTRIBUTION						
	Telephone splitter with 2 x 4 outputs		4	4 130 12	<input type="text"/>	
	ADSL master filter, analogue telephone splitter with 3 outputs		2	4 130 15	<input type="text"/>	
	TV coaxial splitter - 6 outputs - HD Ready		4	4 130 13	<input type="text"/>	
	4+1 RJ 45 port switch - Gigabit Ethernet		4	4 130 09	<input type="text"/>	
	4+1 RJ 45 port switch - 10/100 Ethernet Mbit/s	or	4	4 130 10	<input type="text"/>	
	Modular power supply 9 V	+	1.5	4 130 17	<input type="text"/>	
INSTALLATION ADD-ONS						
	Internet provider box holder <b>N</b>		-	4 130 49	<input type="text"/>	
	Patch cord for connecting the multimedia equipment	Length 2 m	-	0 517 63	<input type="text"/>	
		Length 3 m	-	0 517 64	<input type="text"/>	
	Patch cord for connecting a telephone		Length 2 m	-	0 516 94	<input type="text"/>
	Patch cord for connecting a TV		Length 2 m	-	0 910 24	<input type="text"/>
	Cable F/UTP 4 pairs - supplied on reel		Length 305 m	-	0 328 56	<input type="text"/>
	Cable U/UTP 4 pairs - supplied on reel		Length 305 m	-	0 327 54	<input type="text"/>

# Classic home network

create your enclosure (continued)



Installation principles and technical characteristics **p. 430**

This multimedia modular system fits in any DIN cabinet (easy plug) and in 19" cabinet with the multi-application DIN rail kit (p. 706) System to distribute in the home: phone, data, internet on RJ 45 and TV over coaxial Each RJ 45 can be affected to a different application via patch cords, using the same network, therefore giving maximum flexibility Aesthetics and look of the enclosure designed to give maximum satisfaction. No cable nor patch cords visible. Using RJ 45 patch modules ensures good connections along time and reduces maintenance

Pack	Cat.Nos	Create multimedia network to your specification
4	4 130 01	<b>Patch equipment</b> RJ 45 modular DIN patch module. IP 20 - IK 04 Equipped with RJ 45 UTP connector, Reversible front panel to make it easier to manage outputs facing up or down 2 levels of identification : through a label-holder to indicate the room it is connected to, and through a rotative wheel to show the distributed media Size: 1 DIN module
4	4 130 47	Flexible patch cord - 0.2 m
4	4 130 48	Flexible patch cord - 0.4 m
1	4 130 12	<b>Equipment for incoming telephone and distribution</b> IP 20 - IK 04 Distributes phone up to 8 terminal sockets Can manage 2 lines (1 incoming line - 8 outputs or 2 incoming lines - 4 outputs for each one) Connection: terminal blocks or RJ 45 connector For POTS and ISDN lines Size: 4 DIN modules
1	4 130 15	<b>ADSL filter/Analogue telephone splitter</b> 3 outputs + 1 modem output for the ADSL/Box filter connection Provides simultaneous ADSL telephone and internet access without using filters on the wall sockets Size: 2 DIN modules
1	4 130 13	<b>Equipment for television distribution</b> IP 20 - IK 04 TV coaxial splitter 1 input 6 type "F" outputs - HD Ready 5 - 2400 MHz Supplied with 3 end plugs and 7 "F" plugs Size: 4 DIN modules
1	4 130 09	<b>4+1 RJ 45 ports Ethernet switches</b> IP 20 - IK 04 Ethernet network switch 9 V power supply Size: 4 DIN modules
1	4 130 10	1 gigabit 10/100 Mbits
1	4 130 17	<b>Power supply</b> Modular power supply 9 V Used to power up to 2 active products: switch Cat.Nos 4 130 09/10, TV splitter Cat.Nos 4 130 18/19 Size: 1.5 DIN modules N.B.: to supply 1 Triple Play unit Cat.No 4 130 44, 1 power supply unit needed. For 2 Triple Play units Cat.No 4 130 44, 2 power supply units needed

Pack	Cat.Nos	Cables and patch cords for multimedia networks
1	0 328 56	<b>Cat. 6 cables for local area networks</b> 4 twisted pair cables 100 ohms LSZH sleeve: zero halogen. EIA/TIA colour code F/UTP - 4 pairs Length 305 m Supplied on reel. Weight 25 kg
1	0 327 54	U/UTP - 4 pairs Length 305 m Supplied on reel. Weight 16 kg
1	0 517 63	<b>RJ 45-RJ 45 patch cords for connecting multimedia equipment</b> Conform to standards ISO/IEC 11801 ed. 2.0, EN 50173-1 and EIA/TIA 568 EIA/TIA colour code Length 2 m
1	0 517 64	Length 3 m
10	0 516 94	Cable for connecting a telephone Length 2 m
10	Gencod packaging 0 910 24	<b>Ø9.52 patch cord for connecting a TV</b> Length 2 m
10	5 723 14	<b>RJ 45 and TV-R-SAT sockets</b> Mechanisms supplied with white or magnesium square cover plates. To be equipped with support frames and plates (p. 386 to 393)
10	5 728 14	<b>RJ 45 sockets- Cat. 6 - UTP</b> 2 modules ○ White ● Magnesium
10	5 721 72	<b>TV-R-SAT sockets shielded</b> TV: 5-68/120-862 MHz R: 87.5-108 MHz SAT: 950-2400 MHz Star - 1.5 dB 2 modules
10	5 726 72	○ White ● Magnesium

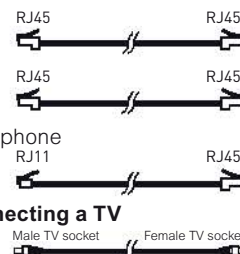

Video of Classic Home Network



Pack	Cat.Nos	Installation add-ons
1	4 130 49	<b>Internet provider box holder</b> Used to mount and connect the Operator
1	4 132 05	<b>Patch cord remote box</b> Used when the operator box is not in cabinet Allowing to supply the operator box and return Internet and IPTV signals in the home Network cabinet using only one RJ 45

# Evolutionary home network

create your enclosure

RJ 45 SOCKETS		Numbers of modules	Cat.Nos	Qty to order		
	Arteor RJ 45 sockets - UTP	White	2	5 723 14	<input type="text"/>	
		Magnesium	2	5 728 14	<input type="text"/>	
TV-R-SAT SOCKETS						
	Arteor TV-R-SAT socket	White	2	5 721 72	<input type="text"/>	
		Magnesium	2	5 726 72	<input type="text"/>	
PATCH EQUIPMENT						
	RJ 45 Modular DIN patch module - UTP		1	4 130 01	<input type="text"/>	
	Flexible patch cord - 0.2 m	+	-	4 130 47	<input type="text"/>	
	Flexible patch cord - 0.4 m	or	-	4 130 48	<input type="text"/>	
EQUIPMENT FOR INCOMING TELEPHONE, TELEVISION, ADSL, AND DISTRIBUTION						
	Automatic <sup>Gigabit</sup> Triple Play unit/8 outputs		8	4 130 44	<input type="text"/>	
	Modular power supply 9 V	+	1.5	4 130 17	<input type="text"/>	
	ADSL master filter, analogue telephone splitter with 3 outputs		2	4 130 15	<input type="text"/>	
	TV coaxial splitter - 6 outputs - HD Ready		4	4 130 13	<input type="text"/>	
INSTALLATION ADD-ONS						
	Internet provider box holder <b>N</b>		-	4 130 49	<input type="text"/>	
	Patch cord for connecting the multimedia equipment	Length 2 m	-	0 517 63	<input type="text"/>	
		Length 3 m	-	0 517 64	<input type="text"/>	
	Patch cord for connecting a telephone		Length 2 m	-	0 516 94	<input type="text"/>
	Patch cord for connecting a TV		Length 2 m	-	0 910 24	<input type="text"/>
	Cable F/UTP 4 pairs - supplied on reel		Length 305 m	-	0 328 56	<input type="text"/>
	Cable U/UTP 4 pairs - supplied on reel		Length 305 m	-	0 327 54	<input type="text"/>

# Evolutionary home network

## create your enclosure (continued)



### Installation principles and technical characteristics p. 431

This multimedia modular system fits in any DIN cabinet (easy plug) and in 19" cabinet with the multi-application DIN rail kit (p. 706) Makes it possible to have the incoming fibre optic point in the home (FTTH Ready) Home Network system allowing an automatic distribution of telephone, internet, data and IPTV. The system has an automatic recognition of the devices connected to the RJ 45 giving maximum flexibility to the end-user RF television distribution (cable TV, aerial or satellite) is done over the coaxial network Aesthetics and look of the enclosure is designed to give maximum satisfaction. No cable nor patch cords visible Using RJ 45 patch modules ensures good connections along time and reduces maintenance

Pack	Cat.Nos	Create multimedia network to your specification	Pack	Cat.Nos	Cables and patch cords for multimedia networks
4	4 130 01	<b>Patch equipment</b> RJ 45 modular DIN patch module. IP 20 - IK 04 Equipped with RJ 45 UTP connector, Reversible front panel to make it easier to manage outputs facing up or down 2 levels of indentification : through a label-holder to indicate the room it is connected to, and through a rotative wheel to show the distributed media Size: 1 DIN module	1	0 328 56	<b>Cat. 6 cables for local area networks</b> 4 twisted pair cables 100 ohms LSZH sleeve: zero halogen EIA/TIA colour code F/UTP - 4 pairs Length 305 m Supplied on reel. Weight 25 kg
4	4 130 47	Flexible patch cord - 0.2 m	1	0 327 54	U/UTP - 4 pairs Length 305 m Supplied on reel. Weight 16 kg
4	4 130 48	Flexible patch cord - 0.4 m	10	0 516 63	<b>RJ 45-RJ 45 patch cords for connecting multimedia equipment</b> Conform to standards ISO/IEC 11801 ed. 2.0, EN 50173-1 and EIA/TIA 568 EIA/TIA colour code Length 2 m
1	4 130 44	<b>Equipment for incoming telephone, IP television and internet, and distribution</b> IP 20 - IK 04 Automatic <sup>Gigabit</sup> Triple Play unit. Used to distribute High-Speed services from the Operator box to 8 RJ 45 sockets - 8 modules, compatible with IP V6 and IP V4 Use only with power supply Cat.No 4 130 17 Size: 8 DIN modules	1	0 517 64	Length 3 m
1	4 130 15	<b>Equipment for incoming telephone and distribution</b> IP 20 - IK 04 ADSL filter/Analogue telephone splitter 3 outputs + 1 modem output for the ADSL/Box filter connection Provides simultaneous ADSL telephone and internet access without using filters on the wall sockets Size: 2 DIN modules	10	0 516 94	Cable for connecting a telephone Length 2 m
1	4 130 13	<b>Equipment for television distribution</b> IP 20 - IK 04 TV coaxial splitter 1 input 6 type "F" outputs - HD Ready 5 - 2400 MHz Supplied with 3 end plugs and 7 "F" plugs Size: 4 DIN modules	10	Gencod packaging 0 910 24	<b>Ø9.52 patch cord for connecting a TV</b> Length 2 m
1	4 130 17	<b>Modular power supply</b> Modular power supply 9 V Used to power up to 2 active products: switch Cat.Nos 4 130 09/10, TV splitter Cat.Nos 4 130 18/19 Size: 1.5 DIN modules N.B.: to supply 1 Triple play unit Cat.No 4 130 44, 1 power supply unit needed. For 2 Triple play units Cat.No 4 130 44, 2 power supply units needed	10	5 723 14	<b>RJ 45 and TV-R-SAT sockets</b> Mechanisms supplied with white or magnesium square cover plates To be equipped with support frames and plates (p. 386 to 393)
			10	5 728 14	<b>RJ 45 sockets- Cat. 6 - UTP</b> 2 modules <input type="radio"/> White <input type="radio"/> Magnesium
			10	5 721 72	<b>TV-R-SAT sockets shielded</b> TV: 5-68/120-862 MHz R: 87.5-108 MHz SAT: 950-2400 MHz Star - 1.5 dB 2 modules
			10	5 726 72	<input type="radio"/> White <input type="radio"/> Magnesium
			1	4 130 49	<b>Installation add-ons</b> <b>Internet provider box holder</b> Used to mount and connect the Operator
			1	4 132 05	<b>Patch cord remote box</b> Used when the operator box is not in cabinet Allowing to supply the operator box and return Internet and IPTV signals in the home Network cabinet using only one RJ 45

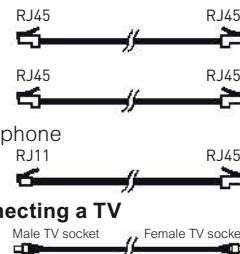

# Evolute + home network

create your enclosure

RJ 45 SOCKETS		Numbers of modules	Cat.Nos	Qty to order		
	Arteor RJ 45 sockets - STP	White	2	5 723 17	<input type="text"/>	
		Magnesium	2	5 728 17	<input type="text"/>	
<b>PATCH EQUIPMENT</b>						
	RJ 45 Modular DIN patch module - STP		1	4 130 03	<input type="text"/>	
	Multimedia patch cord - 0.2 m	+	-	4 130 45	<input type="text"/>	
	Multimedia patch cord - 0.4 m	or	-	4 130 46	<input type="text"/>	
<b>EQUIPMENT FOR INCOMING TELEPHONE, TELEVISION, ADSL, AND DISTRIBUTION</b>						
	Automatic <sup>Gigabit</sup> Triple Play unit/8 outputs		8	4 130 44	<input type="text"/>	
	Modular power supply 9 V	+	1.5	4 130 17	<input type="text"/>	
	ADSL master filter, analogue telephone splitter with 3 outputs		2	4 130 15	<input type="text"/>	
	TV RJ 45 amplifier splitter - 4 outputs (Terrestrial TV - SAT TV)		4	4 130 18	<input type="text"/>	
	TV RJ 45 amplifier splitter - 4 outputs (Terrestrial TV - Cable TV)	or	4	4 130 19	<input type="text"/>	
<b>INSTALLATION ADD-ONS</b>						
	Internet provider box holder <b>N</b>		-	4 130 49	<input type="text"/>	
	Patch cord for connecting the multimedia equipment	Length 2 m	-	0 517 63	<input type="text"/>	
		Length 3 m	-	0 517 64	<input type="text"/>	
	Patch cord for connecting a telephone		Length 2 m	-	0 516 94	<input type="text"/>
	RJ 45 IEC + F patch cord for connecting a TV or digital receiver		Length 2 m	-	4 130 40	<input type="text"/>
	Multimedia (FFTP) twisted pair cable		Length 100 m	-	0 327 89	<input type="text"/>

# Evolute + home network

## create your enclosure (continued)



Installation principles and technical characteristics **p. 431**

This multimedia modular system fits in any DIN cabinet (easy plug) and in 19" cabinet with the multi-application DIN rail kit (p. 706) Makes it possible to have the incoming fibre optic point in the home (FTTH Ready) Home Network system allowing an automatic distribution of telephone, internet, data and IPTV. The system has an automatic recognition of the devices connected to the RJ 45 giving maximum flexibility to the end-user RF television distribution (cable TV, aerial or satellite) is added to the RJ 45 socket network by using the TV over RJ 45 splitters Aesthetics and look of the enclosure is designed to give maximum satisfaction. No cable nor patch cords visible Using RJ 45 patch modules ensures good connections along time and reduces maintenance

Pack	Cat.Nos	Create multimedia network to your specification	Pack	Cat.Nos	Cables and patch cords for multimedia networks
4	4 130 03	<b>Patch equipment</b> RJ 45 Modular DIN patch module. IP 20 - IK 04 Equipped with RJ 45 STP connector, Reversible front panel to make it easier to manage outputs facing up or down 2 levels of indentification : through a label-holder to indicate the room it is connected to, and through a rotative wheel to show the distributed media Size: 1 DIN module	1	0 327 89	<b>Multimedia (FFTP) twisted pair cable</b> LSZH sleeve: zero halogen. F/FTP - 100 Ω Optimised performance for transmission of satellite signals (2150 MHz) Length 100 m Supplied on reel. Weight 6 kg
4	4 130 45	Multimedia patch cord - 0.2 m	1	0 517 63	<b>RJ 45-RJ 45 patch cords for connecting multimedia equipment</b> Conform to standards ISO/IEC 11801 ed. 2.0, EN 50173-1 and EIA/TIA 568 EIA/TIA colour code Length 2 m
4	4 130 46	Multimedia patch cord - 0.4 m	1	0 517 64	Length 3 m
1	4 130 44	<b>Equipment for incoming telephone, ADSL television and internet, and distribution</b> IP 20 - IK 04 Automatic <sup>Gigabit</sup> Triple Play unit. Used to distribute ADSL services from the Operator box to 8 RJ 45 sockets - 8 modules, compatible with IP V6 and IP V4 Use only with power supply Cat.No 4 130 17 Size: 8 DIN modules	10	0 516 94	Cable for connecting a telephone Length 2 m
1	4 130 15	<b>Equipment for incoming telephone and distribution</b> IP 20 - IK 04 ADSL filter/Analogue telephone splitter 3 outputs + 1 modem output for the ADSL/Box filter connection Provides simultaneous ADSL telephone and internet access without using filters on the wall sockets Size: 2 DIN modules	1	4 130 40	<b>Coaxial patch cord for connecting a TV</b> RJ 45-IEC-F TV cable Length 2 m Supplied with accessory for adaptation to IEC Ø9.52 mm
1	4 130 18	<b>Equipment for television distribution using RJ 45</b> IP 20 - IK 04 TV RJ 45 amplifier - splitter (terrestrial TV - SAT TV) Transmission distance: - 5 to 40 m for terrestrial-DTT - 5 to 30 m for satellite 4 RJ 45 outputs Supplied with adjustment kit 9 V power supply Size: 4 DIN modules	10	5 723 17	<b>RJ 45 sockets</b> Mechanisms supplied with white or magnesium square cover plates To be equipped with support frames and plates (p. 386 to 393)
1	4 130 19	TV RJ 45 amplifier - splitter (terrestrial TV - Cable TV) with return channel Transmission distance: 5 to 30 metres 4 RJ 45 outputs 9 V power supply Size: 4 DIN modules	10	5 728 17	<b>RJ 45 sockets- Cat. 6 - STP</b> 2 modules ○ White ● Magnesium
1	4 130 17	<b>Modular power supply</b> Modular power supply 9 V Used to power up to 2 active products: switch Cat.Nos 4 130 09/10, TV splitter Cat.Nos 4 130 18/19 Size: 1.5 DIN modules N.B.: to supply 1 Triple Play unit Cat.No 4 130 44, 1 power supply unit needed. For 2 Triple Play units Cat.No 4 130 44, 2 power supply units needed	1	4 130 49	<b>Installation add-ons</b> <b>Internet provider box holder</b> Used to mount and connect the Operator
			1	4 132 05	<b>Patch cord remote box</b> Used when the operator box is not in cabinet Allowing to supply the operator box and return Internet and IPTV signals in the home Network cabinet using only one RJ 45

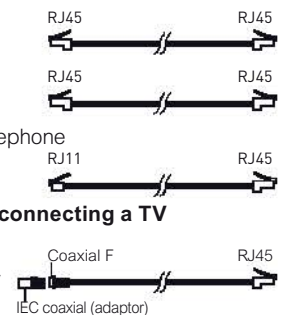

## Classic home network

### Classic home network - operator box in cabinet

Cable U/UTP Cat.No 0 327 54 or F/UTP Cat.No 0 328 56

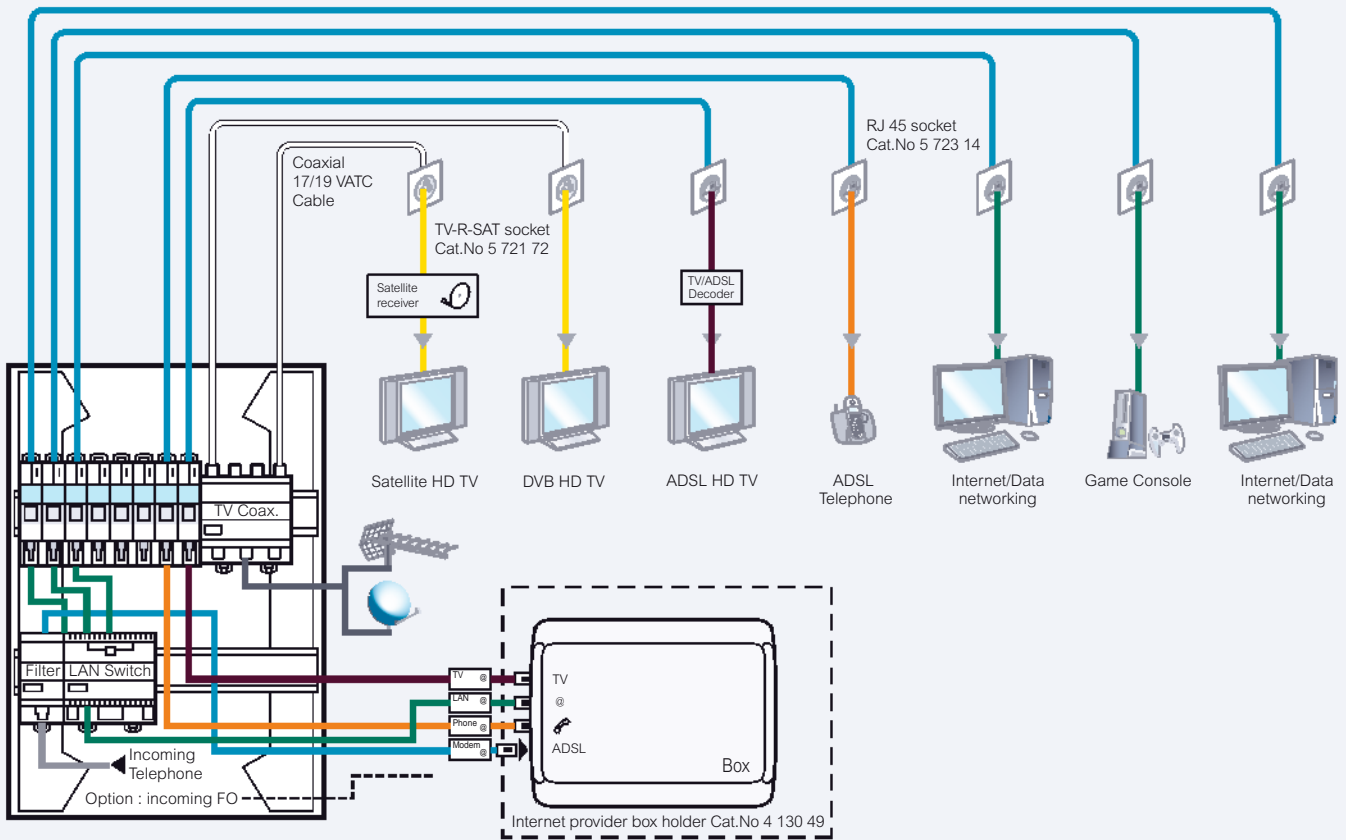

### Classic home network - operator box not in cabinet

Cable U/UTP Cat.No 0 327 54 or F/UTP Cat.No 0 328 56

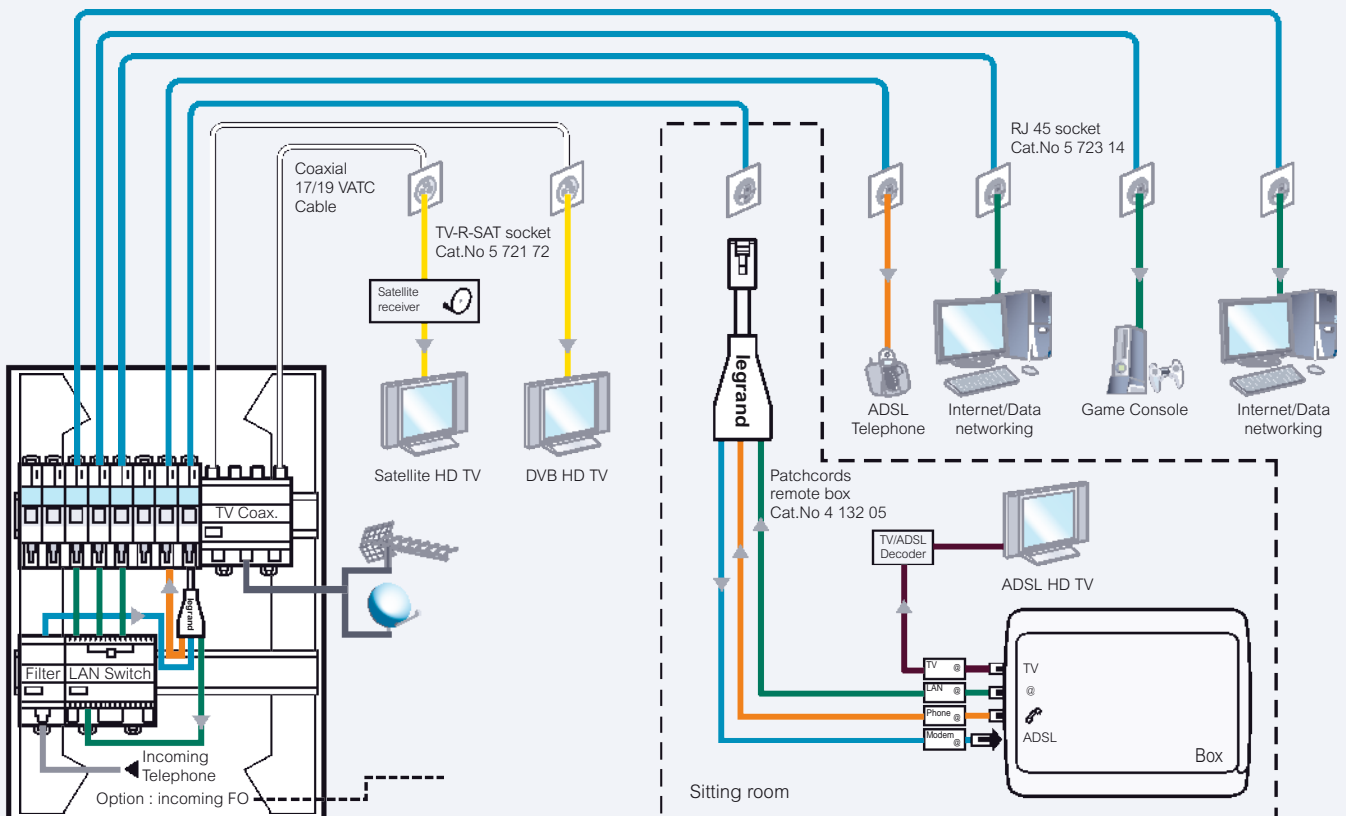



## Evolute and Evolute + home network

### Evolute home network - operator box in cabinet

Cable U/UTP Cat.No 0 327 54 or F/UTP Cat.No 0 328 56

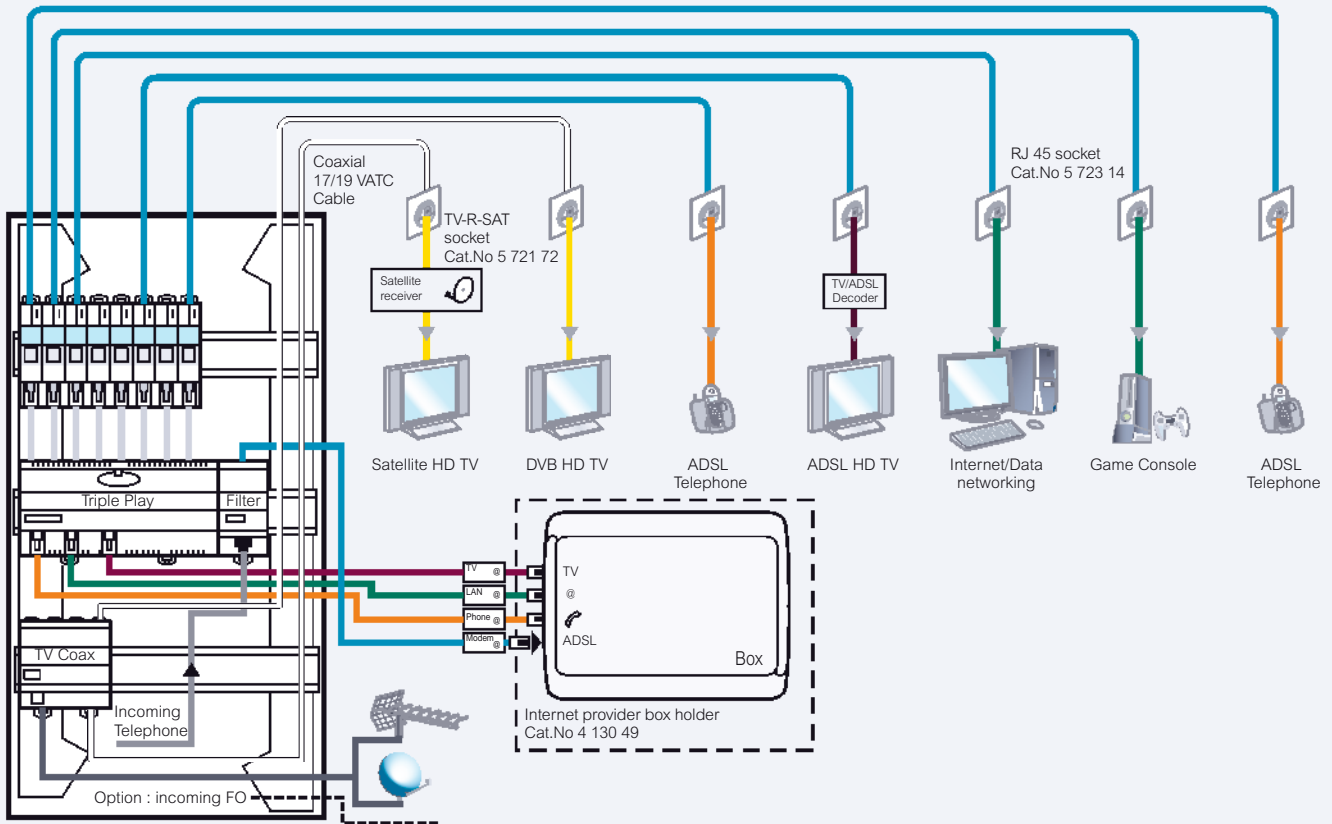

### Evolute + home network - operator box not in cabinet

Multimedia (FFTP) twisted pair cable Cat.No 0 327 89

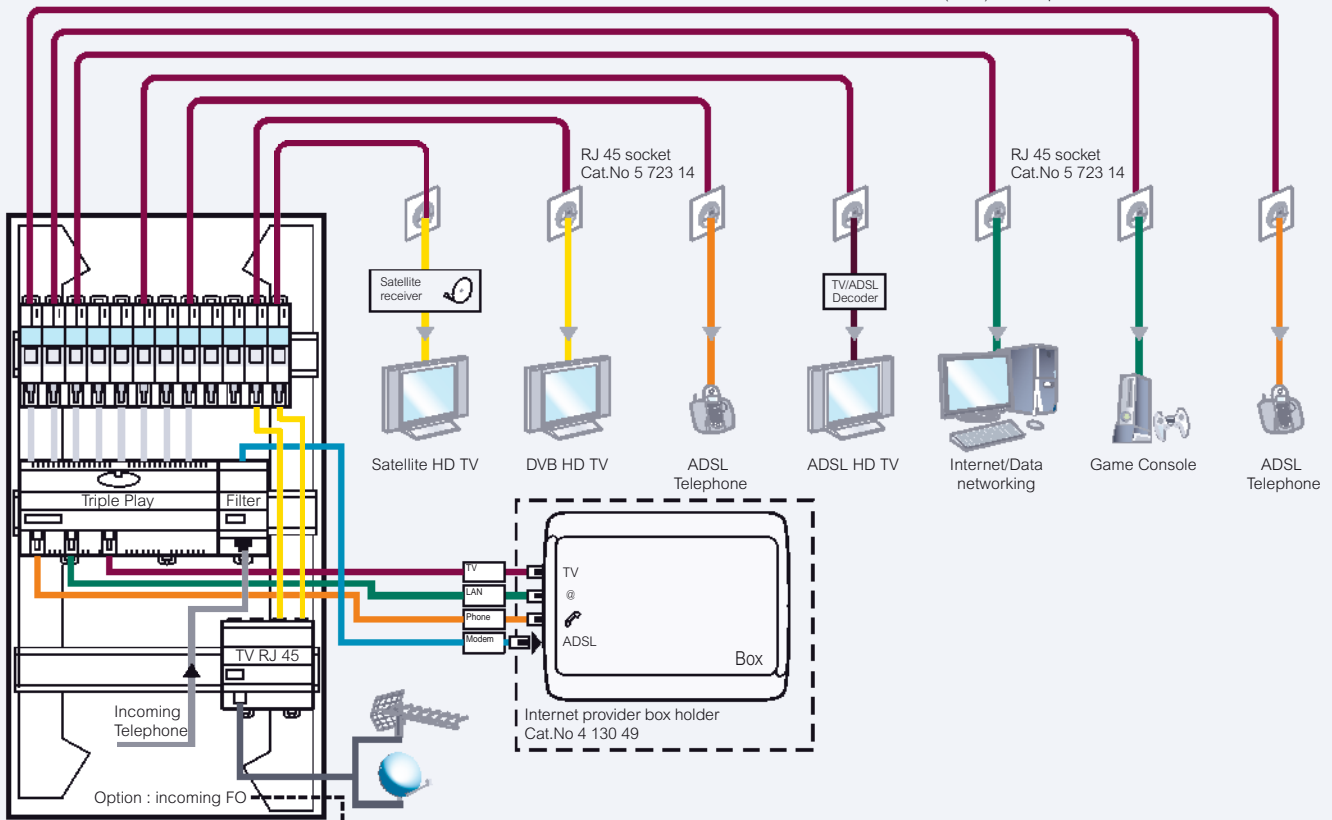

## FttH - Fibre to the Home

preterminated solution



## FttH - Fibre to the Home

prewired solution - requires fusion splicing



4 130 67

Recommended for high-rise buildings (up to 60 apartments for 4 OF or 120 apartments for 2 OF)

Does not require a device for splicing the fibre at the FD

Pack	Cat.Nos	Building entry point (BEP)
1	4 130 61	The BEP is located in the dedicated equipment room located at the base of the building It makes the client fibres available to the future operator and makes their patch connection easy If required, can have more feedthroughs Technical characteristics: - Dim. (mm): 440 (L) x 175 (H) x 102 (D) - 2 cable entries (max. Ø: 15 mm) - Contains 48 feedthroughs for SC/APC connectors BEP for 12 x 4 OF subscribers or 24 x 2 OF subscribers BEP with 48 SC/APC feedthroughs for preterminated solution
1	4 130 75	<b>Excess length management box for OTO optical fibre cable</b> Coiling box for storing excess lengths of preterminated OTO fibres
1	4 130 67	<b>Optical telecommunications outlet (OTO) - prewired and preterminated</b> The OTO is the termination point of the FTTH installation in the home. It is fixed in the home network cabinet and enables connection to the operator box. The prewired and preterminated version enables direct connection to the BEP via the connectors for tool-free mounting on-site The pulling cord makes it easy to use in the riser and in conduits (Ø20 mm recommended) Technical characteristics: - For fixing on DIN rail or wall - Preterminated at both ends - G657A2 900 µm - Cable diameter: 4.2 mm - Pulling cord diameter: 11 mm
1	4 130 69	<b>Prewired and preterminated OTO - 2 OF</b> OTO with 2 SC/APC feedthroughs + 25 m of cable preterminated at both ends
1	4 130 68	<b>Prewired and preterminated OTO - 4 OF</b> OTO with 4 SC/APC feedthroughs + 25 m of cable preterminated at both ends
1	4 130 70	OTO with 2 SC/APC feedthroughs + 40 m of cable preterminated at both ends
10	4 130 71	<b>Spare connectors</b> Bag of 10 SC/APC connector covers for preterminated OTO



4 130 62



4 130 63

Recommended for high-rise buildings (up to 60 apartments for 4 OF or 120 apartments for 2 OF)

Requires a device for splicing the fibre at the FD

Pack	Cat.Nos	Building entry point (BEP)
1	4 130 60	The BEP is located in the dedicated equipment room located at the base of the building It makes the client fibres available to the future operator and makes their patch connection easy If required, can have more feedthroughs Technical characteristics: - Dimensions (mm): 440 (L) x 175 (H) x 102 (D) - 2 cable entries (max. diameter: 15 mm) - Contains 48 feedthroughs for SC/APC connectors BEP for 12 x 4 OF subscribers or 24 x 2 OF subscribers BEP with 48 SC/APC feedthroughs for prewired solution
1	4 130 72	<b>Prewired riser</b> For routing fibres inside the riser. The cable is preterminated at 1 end for easy connection to the BEP The opening in the cable is made using the tool provided for this purpose (Cat.No 4 130 74) Technical characteristics: - G657, LZOH fibres - 900 µm modules containing 4 fibres
1	4 130 73	<b>Riser</b> Riser 48 OF - 50 m
1	4 130 74	<b>Riser</b> Riser 96 OF - 50 m
1	4 130 74	<b>Tool</b> Riser opening tool
1	4 130 62	<b>Floor distributor (FD)</b> Interface unit between the riser and the client cable from the OTO, enabling fusion splicing using a special tool The FD is installed in the telecommunications riser Technical characteristics: - Dimensions (mm): 138 (L) x 204 (H) x 55 (D) - Contains 4 cassettes for 32 fusion splices max. FD for 8 x 4 OF subscribers or 16 x 2 OF subscribers FD with 4 cassettes
1	4 130 63	<b>Optical telecommunications outlet (OTO) - prewired</b> The OTO is the termination point of the FTTH installation in the home It is fixed in the home network cabinet and enables connection to the operator box Links the OTO and the FD Technical characteristics: - For fixing on DIN rail or wall - Preterminated at one end - Available in versions with 2 or 4 G657A2 900 µm - Cable diameter: 4.2 mm
1	4 130 65	<b>Prewired OTO - 2 OF</b> OTO with 2 SC/APC feedthroughs + 25 m of cable OTO with 2 SC/APC feedthroughs + 40 m of cable
1	4 130 64	<b>Prewired OTO - 4 OF</b> OTO with 4 SC/APC feedthroughs + 25 m of cable OTO with 4 SC/APC feedthroughs + 40 m of cable

## FttH - Fibre to the Home

### preterminated and prewired solution

## FttH - other components

### Preterminated solution

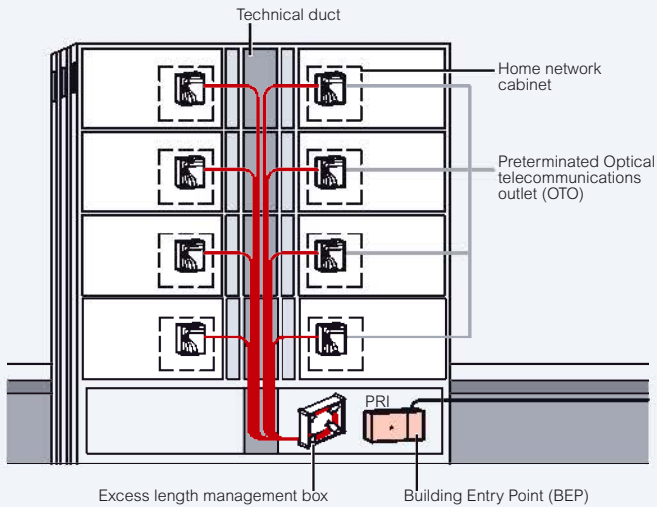

### Diagram of the steps in setting up the prewired and preterminated OTO

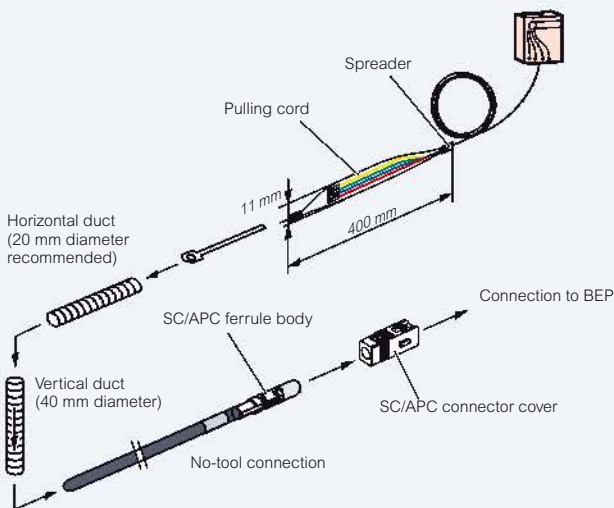

### Prewired solution

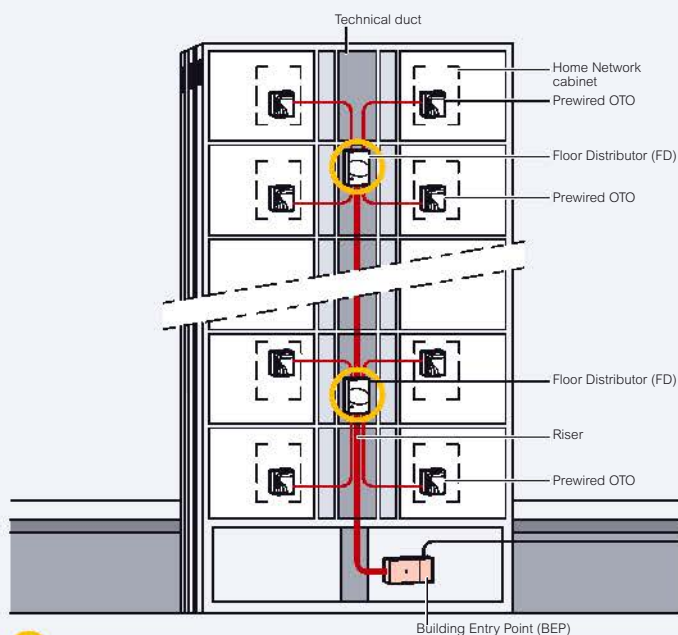

Fusion splicing required



4 130 50



4 130 51

### Pack Cat.Nos Internal optical termination device/Optical telecommunications outlet

Pack	Cat.Nos	Description
1	4 130 50	Unit for 1 optical fibre + SC/APC connector
1	4 130 51	Unit for 4 optical fibres + SC/APC connector

### Pigtail and patch cord

4	0 326 19	SC/APC pigtail, length 1 m
3	0 326 18	SC/APC simplex cord, length 2 m



Prewired preterminated OTO with 1, 2 or 4 fibres

Prewired vertical riser cable

**For made-to-measure solutions, please contact your local Legrand sales office**



# OTHER WIRING ACCESSORIES

## Kaptika™ Forix™



**NEW**  
P. 436  
Kaptika  
flush-mounting

## Niloé™



**NEW**  
P. 442  
Niloé  
switches,  
push-buttons,  
dimmers



P. 449  
Niloé  
special  
projects-switches  
and push-buttons

## Valena™



P. 452  
Switches,  
push-buttons,  
dimmers

## Galea™ Life



P. 466  
Switches,  
dimmers,  
push-buttons

## Vela™



P. 484  
Rocker plates

## NEW PRODUCTS 2014



**Kaptika™  
flush-mounting**  
- 2P+E German standard socket  
outlet with shutters  
- Double two-way switch  
(p. 436-437)



**Niloé™  
special projects**  
A range to suit  
your budget  
(p. 448)



**NEW**  
P. 438  
Forix  
IP2X surface-  
mounting

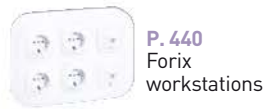

P. 440  
Forix  
workstations



P. 441  
Forix  
IP 44 surface-  
mounting



P. 445  
Shutters  
and fan controls,  
keycard switch



P. 445  
Socket outlets



P. 446  
TV,  
telephone and  
data sockets

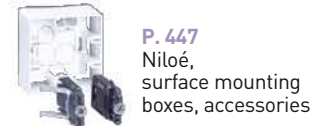

P. 447  
Niloé,  
surface mounting  
boxes, accessories



**NEW**  
P. 449  
Niloé  
special  
projects socket  
outlets



**NEW**  
P. 450  
Niloé  
special projects  
TV, telephone, data  
sockets



**NEW**  
P. 451  
Plates



P. 455  
Television, data  
and telephone  
sockets



P. 457  
Audio/video  
sockets



**NEW**  
P. 458  
Socket outlets,  
USB chargers



**NEW**  
P. 465  
Plates



P. 470  
Data, TV and  
telephone  
sockets



P. 471  
Socket outlets

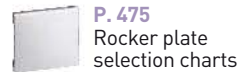

P. 475  
Rocker plate  
selection charts



P. 482  
Plate selection  
charts

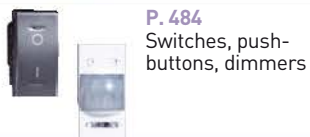

P. 484  
Switches, push-  
buttons, dimmers



P. 486  
Socket outlets,  
telephone, data,  
TV sockets

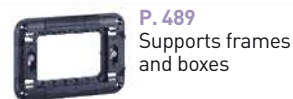

P. 489  
Supports frames  
and boxes



P. 490  
Plate selection  
charts



**Valena™**  
USB Chargers  
(p. 459)



**Valena™**  
- aluminium cover  
plates  
- plates  
(p. 463 to 465)

# Kaptika™

flush-mounting switches and socket outlets



Conform to CE directive  
 Mechanisms supplied complete with cover plates and plates  
 Screw or claw mounting  
 2 finishes:  
 - White RAL R910 - Glossy finish  
 - Ivory RAL R113 - Glossy finish

## Pack Cat.Nos Switches 10 AX- 250 V~

Pack	Cat.Nos	Switches 10 AX- 250 V~
20	7 821 00	<b>One-way switch</b> ○ White ● Ivory
50	7 821 30	
50	7 821 04	<b>Two-way switch</b> ○ White ● Ivory
50	7 821 34	
50	7 821 01	<b>One-way switch with indicator function</b> Supplied with a green LED 1 mA Connection as a status indicator or locator function ○ White ● Ivory
50	7 821 31	
20	7 821 02	<b>Double one-way switch</b> ○ White ● Ivory
50	7 821 32	
20	<b>N</b> 7 821 29	<b>Double two-way switch</b> ○ White ● Ivory
20	7 821 59	
50	7 821 03	<b>Double one-way switch with indicator function</b> Supplied with a green LED 1 mA Connection as a status indicator or locator function on one circuit ○ White ● Ivory
50	7 821 33	

## Push-buttons 6 A - 250 V~

Pack	Cat.Nos	Push-buttons 6 A - 250 V~
20	7 821 05	<b>Push-button</b> ○ White ● Ivory
20	7 821 35	
20	7 821 06	<b>Illuminated push-button</b> Supplied with a green LED - 1 mA ○ White ● Ivory
20	7 821 36	
20	7 821 07	<b>Push-button with "bell" symbol</b> ○ White ● Ivory
20	7 821 37	

## Pack Cat.Nos 2P socket outlets 16 A - 250 V~

Pack	Cat.Nos	2P socket outlets 16 A - 250 V~
50	7 821 10	<b>2P</b> ○ White ● Ivory
50	7 821 40	
20	7 821 20	<b>2P with shutters for child safety</b> ○ White ● Ivory
20	7 821 50	
30	7 821 12	<b>2 x 2P</b> ○ White ● Ivory
30	7 821 42	



# Kaptika™

flush-mounting French and German standard socket outlets

# Kaptika™

flush-mounting telephone, data and TV sockets



Conform to CE directive  
Mechanisms supplied complete with cover plates and plates  
Screw or claw mounting  
2 finishes:  
- White RAL R910 - Glossy finish  
- Ivory RAL R113 - Glossy finish

Conform to CE directive  
Mechanisms supplied complete with cover plates and plates  
Screw or claw mounting  
2 finishes:  
- White RAL R910 - Glossy finish  
- Ivory RAL R113 - Glossy finish

Pack Cat.Nos **German standard socket outlets**

20	7 821 11	<b>16 A - 250 V~</b> <b>2P+E</b> <ul style="list-style-type: none"> <li><input type="radio"/> White</li> <li><input type="radio"/> Ivory</li> </ul>
50	7 821 41	

30	7 821 13	<b>2 x 2P+E</b> <ul style="list-style-type: none"> <li><input type="radio"/> White</li> <li><input type="radio"/> Ivory</li> </ul>
10	7 821 43	

Pack Cat.Nos **French standard socket outlets**

50	7 821 17	<b>16 A - 250 V~</b> <b>2P+E</b> <ul style="list-style-type: none"> <li><input type="radio"/> White</li> <li><input type="radio"/> Ivory</li> </ul>
50	7 821 47	

50	7 821 27	<b>2P+E with shutters for child safety</b> <ul style="list-style-type: none"> <li><input type="radio"/> White</li> <li><input type="radio"/> Ivory</li> </ul>
20	7 821 57	

Pack Cat.Nos **RJ 11 telephone sockets**

50	7 821 14	Automatic connection with perforation of the insulating material Supplied with a tool <ul style="list-style-type: none"> <li><input type="radio"/> White</li> <li><input type="radio"/> Ivory</li> </ul>
50	7 821 44	

Pack Cat.Nos **RJ 45 UTP cat. 5e sockets**

20	7 821 24	Supplied with a tool <ul style="list-style-type: none"> <li><input type="radio"/> White</li> <li><input type="radio"/> Ivory</li> </ul>
20	7 821 54	

Pack Cat.Nos **Television sockets**

50	7 821 15	Terminal TV sockets Male connector Ø9.52 mm Supplied with a connector to screw on the cable <ul style="list-style-type: none"> <li><input type="radio"/> White</li> <li><input type="radio"/> Ivory</li> </ul>
50	7 821 45	

Pack Cat.Nos **Cable outlets**

50	7 821 16	Supplied with cable ties <ul style="list-style-type: none"> <li><input type="radio"/> White</li> <li><input type="radio"/> Ivory</li> </ul>
50	7 821 46	

Pack Cat.Nos **Universal flush-mounting box**

250	0 313 01	 1 gang unit Can be fitted alongside one another Can be used as junction box with cover Cat.No 0 892 81 (p. 566)
20	0 892 81	 Square cover 80 x 80 mm, for 1 gang box Cat.No 0 313 01 (p. 566)

# Forix™

## IP 2X surface-mounting switches and socket outlets



7 824 00



7 824 20



7 824 23

Conform to IEC standard  
 Complete mechanisms supplied with rocker and cover plate - Screw terminals IP2X  
 2 finishes:  
 - White RAL R903 - Gloss finish  
 - Ivory RAL R113 - Gloss finish

Pack	Cat.Nos	Switches 10 AX - 250 V~
20	7 824 00	<b>Become illuminated with LED lamp Cat. No. 7 824 57</b> <b>One-way switch</b> ○ White ● Ivory
20	7 824 30	
20	7 824 04	<b>Two-way switch</b> ○ White ● Ivory
20	7 824 34	
20	7 824 02	<b>2 gang one-way switch</b> ○ White ● Ivory
20	7 824 32	
20	<b>N</b> 7 824 06	<b>2 gang two-way switch</b> ○ White ● Ivory
20	7 824 36	
20	7 824 05	<b>Push-buttons 6 A - 250 V~</b> <b>Become illuminated with LED lamp Cat. No. 7 824 57</b> ○ White ● Ivory
20	7 824 35	

Pack	Cat.Nos	2P socket outlets 16 A - 250 V~
20	7 824 10	<b>2P socket outlets - without shutters</b> ○ White ● Ivory
20	7 824 40	
10	7 824 12	<b>2 x 2P socket outlets - without shutters</b> Inclined 45° - Horizontal or vertical mounting ○ White ● Ivory
10	7 824 42	
20	7 824 11	<b>German standard socket outlets 16 A - 250 V~</b> <b>2P+E socket without shutters</b> ○ White ● Ivory
20	7 824 41	
10	7 824 13	<b>2 x 2P+E socket without shutters</b> Inclined 45° - Horizontal or vertical mounting ○ White ● Ivory
10	7 824 43	
20	7 824 20	<b>2P+E socket with shutters for child protection</b> ○ White ● Ivory
20	7 824 50	
10	7 824 23	<b>2 x 2P+E socket with shutters for child protection</b> Inclined 45° - Horizontal or vertical mounting ○ White ● Ivory
10	7 824 53	
10	7 824 18	<b>3 x 2P+E socket with shutters for child protection</b> Inclined 45° - Horizontal or vertical mounting ○ White ● Ivory
10	7 824 48	





# Forix™

## IP 2X surface-mounting socket outlets, telephone, data and TV sockets



7 824 17



7 824 15



7 824 24



7 824 29

Conform to IEC standard  
 Complete mechanisms supplied with rocker and cover plate. Screw terminals IP2X  
 2 finishes:  
 - White RAL R903 - Gloss finish  
 - Ivory RAL R113 - Gloss finish

Pack	Cat.Nos	French standard socket outlets 16 A - 250 V~	Pack	Cat.Nos	RJ 45 keystone connector adaptor
20 20	7 824 17 7 824 47	<b>2P+E socket with shutters for child protection</b> <ul style="list-style-type: none"> <li>○ White</li> <li>● Ivory</li> </ul>	20	7 824 26	Double connector <ul style="list-style-type: none"> <li>○ White</li> </ul>
10 10	7 824 19 7 824 49	<b>N</b> <b>2x2P+E socket with shutters for child protection</b> Inclined 45° horizontal or vertical mounting <ul style="list-style-type: none"> <li>○ White</li> <li>● Ivory</li> </ul>	20 20	7 824 15 7 824 45	<b>Television sockets</b> Terminal TV socket Male connector Ø9.52 mm <ul style="list-style-type: none"> <li>○ White</li> <li>● Ivory</li> </ul>
20 20	7 824 14 7 824 44	<b>RJ 11 telephone sockets</b> Automatic connection by piercing the insulating material Supplied with a tool <ul style="list-style-type: none"> <li>○ White</li> <li>● Ivory</li> </ul>	20 20	7 824 16 7 824 46	<b>Wire outlets</b> Supplied with cable ties <ul style="list-style-type: none"> <li>○ White</li> <li>● Ivory</li> </ul>
20 20	7 824 21 7 824 51	<b>N</b> <b>RJ 11 telephone socket and RJ 45 cat. 5e - UTP socket</b> Automatic connection by piercing the insulating material Supplied with a tool <ul style="list-style-type: none"> <li>○ White</li> <li>● Ivory</li> </ul>	10	7 824 29	<b>Dismatic - 20 A</b> For protection and control of air-conditioning system Single pole 220 V/380 V thermal MCB <ul style="list-style-type: none"> <li>○ White</li> </ul>
20 20	7 824 24 7 824 54	<b>RJ 45 sockets cat. 5e - UTP</b> Automatic connection by piercing the insulating material Supplied with a tool <b>1 x RJ 45</b> <ul style="list-style-type: none"> <li>○ White</li> <li>● Ivory</li> </ul>	5	7 824 57	<b>Lamp</b> 230 V - Consumption 3.4 mA
20	7 824 28	<b>N</b> <b>2 x RJ 45</b> <ul style="list-style-type: none"> <li>○ White</li> </ul>			

# Forix™

## workstations



7 824 97 + 2 x RJ 45 sockets Cat. No. 7 824 24 (p. 439)

Conform to IEC standard

Ensure cable separation when fully equipped

Label marking areas

Pre-cut entries from 20 x 12.5 mm - up to 40 x 12.5 mm



Take flush-mounting flexible conduits and surface-mounting mini-trunking

The workstations are composed of one plate and one cover plate

Workstations for integration of Forix IP2X surface mounting mechanisms or Mosaic™/Arteor™ mechanisms with adaptor Cat.No 7 824 25

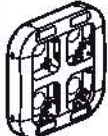
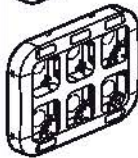
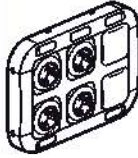
White RAL R903 - Gloss finish

Pack	Cat.Nos	Workstations to be equipped
2	7 824 94	Accept all mechanisms Forix IP2X surface-mounting range 4 gang 
2	7 824 96	Horizontal or vertical mounting 6 gang 
2	7 824 97	<b>Equipped workstations</b> Equipped with: - 4 x 2P+E German standard socket outlets with shutters - 2 blanking plates for integration of Forix mechanisms 

Pack	Cat.Nos	Mosaic™/Arteor™ adaptor
10	7 824 25	Takes 2-module Mosaic™/Arteor™ mechanisms ○ White 
20	7 824 95	<b>Blanking plate</b> Accessory to fill unused workstation spaces 1 gang 



Forix, the evolutive solution for offices and commercial buildings



# Forix™

## IP 44 switches and socket outlets



Conform to IEC standard: switches IEC 60669-1 (01-2007), socket outlets IEC 60884-1 (07-2006)  
 Mechanisms supplied complete with cover plates and plates  
 Surface mounting - screw terminals  
 2 finishes: White RAL R903 (Gloss finish); Grey RAL R735 (Gloss finish)  
 Mechanisms with single large rocker become illuminated with lamp Cat. No. 7 823 98

### Pack Cat.Nos Switches 10 AX - 250 V~

Pack	Cat.Nos	Switches 10 AX - 250 V~
10	7 823 60	<b>One-way switch</b> ○ White ● Grey
10	7 823 80	
10	7 823 63	<b>Two-way switch</b> ○ White ● Grey
10	7 823 83	
10	7 823 62	<b>2 gang one-way switch</b> ○ White ● Grey
10	7 823 82	
10	7 823 61	<b>2 gang two-way switch</b> ○ White ● Grey
10	7 823 81	
10	7 823 66	<b>Double pole switch</b> ○ White ● Grey
10	7 823 86	
10	7 823 65	<b>Intermediate switch</b> ○ White ● Grey
10	7 823 85	
10	7 823 64	<b>Push-buttons 6 A - 250 V~</b>
10	7 823 84	
5	7 823 79	<b>Spare membrane glands</b> ○ White ● Grey
5	7 823 99	
50	7 823 98	<b>Lamp</b> 230 V - Consumption 3.4 mA

### Pack Cat.Nos German standard socket outlets 16 A - 250 V~ + switches

Pack	Cat.Nos	German standard socket outlets 16 A - 250 V~ + switches
10	7 823 73	<b>With shutters</b> <b>2P+E socket</b> ○ White ● Grey
10	7 823 93	
5	7 823 74	<b>2 x 2P+E socket</b> ○ White ● Grey
5	7 823 94	
5	7 823 71	<b>One-way switch + 2P+E socket</b> ○ White ● Grey
5	7 823 91	
5	7 823 72	<b>Double pole switch + 2P+E socket</b> ○ White ● Grey
5	7 823 92	
10	7 823 75	<b>French standard socket outlets 16 A - 250 V~</b> <b>With shutters</b> <b>2P+E socket</b> ○ White ● Grey
10	7 823 95	
5	7 823 77	<b>2 x 2P+E socket</b> ○ White ● Grey
5	7 823 97	
5	7 823 76	<b>Two-way switch + 2P+E socket</b> ○ White ● Grey
5	7 823 96	

Forix, complete and versatile wall-mounting solution





# Niloé™

# Getting it just right

Just right... for the environment and for you the Niloé™ range is manufactured in ISO 14001 certified plants. Constant attention is paid to the environment impact of each simple activity

## PERFECT INSTALLATION

### TIMELESS DESIGN: 11 COLOURS

- Harmonious design for a light and modern look
- White or ivory glossy finish, to dress with a plate in the preferred colour



Mechanisms p. 443

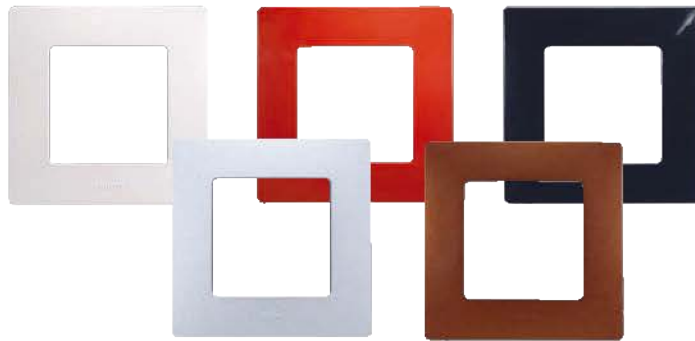

Plates p. 451

## EASY AND COST EFFECTIVE TO CUT INSTALLATION STEPS BY HALF JUST 2 STEPS

**1**



1- Fix the device without removing the protection cover  
2- Remove the protection cover and fit the cover plate

**2**



Claw mounting



Multi-gang installation

### 2 PACKAGING SOLUTIONS

- Legrand boxes
- Delivery by 10 with protection cover



- Flow pack for projects
- A useful protection to guarantee an excellent work



Video of Niloé presentation



# Niloé™

## switches and push-buttons



6 647 01



6 648 01



6 647 10



6 647 05



6 647 09

Mechanisms supplied with cover plates and support frames  
 To be equipped with plates (p. 451)  
 Automatic terminals (except Cat.Nos 6 645 03-6 646 03)  
 Fixing with screws. Fixing with claws using accessory Cat.No 6 650 99 (p. 447)  
 Supplied with site protection cover

Pack	Cat.Nos	Switches 10 AX - 250 V~
10	6 647 01	<b>One-way or two-way switch</b> <input type="radio"/> White <input type="radio"/> Ivory
10	6 648 01	
1	6 643 01	<input type="radio"/> White Pack of 50, specially adapted for work sites
10	6 647 02	<b>2 gang two-way switch</b> <input type="radio"/> White <input type="radio"/> Ivory
10	6 648 02	
10	6 647 10	<b>Illuminated two-way switch</b> Lights with lamps Cat.Nos 6 650 90 or 6 650 92 and indicator with lamp Cat.No 6 650 91 <input type="radio"/> White <input type="radio"/> Ivory
10	6 648 10	
10	6 647 21	<b>IP 44 two-way switch</b> Lights with lamps Cat.Nos 6 650 90 or 6 650 92 and indicator with lamp Cat.No 6 650 91 Mounts on standard plate <input type="radio"/> White <input type="radio"/> Ivory
10	6 648 21	
10	6 645 03	<b>3 gang one-way switch</b> Supplied with claws <input type="radio"/> White - Screw terminals <input type="radio"/> Ivory - Screw terminals
10	6 646 03	
10	6 647 04	<b>Intermediate switch</b> Enables you to add a third control point in a two-way switch installation <input type="radio"/> White <input type="radio"/> Ivory
10	6 648 04	

Pack	Cat.Nos	Switches 16 AX - 250 V~
10	6 647 16	<b>Indicator two-way switch</b> Supplied with lamp Cat.No 6 650 91 <input type="radio"/> White <input type="radio"/> Ivory
10	6 648 16	

Pack	Cat.Nos	Multifunction switches
1	6 647 13	4 functions = 1 reference Supplied with single and double rocker plate to facilitate: - a single two-way switch or a single push-button - a double two-way switch or a double push-button - one two-way switch + push-button (on the left or on the right) <b>1 gang multifunction switch</b> Supplied in push-button mode with single rocker plate fitted. <input type="radio"/> White <input type="radio"/> Ivory
1	6 648 13	

Pack	Cat.Nos	Multifunction switches (continued)
10	6 647 14	<b>2 gang illuminated switch</b> Supplied in 2 gang push-button mode with 2 lamps for illuminating function Cat.No 6 650 90 Supplied with 1 additional non-illuminated rocker plate <input type="radio"/> White <input type="radio"/> Ivory
10	6 648 14	
10	6 647 05	<b>Push-buttons 6 A - 250 V~</b> <b>1 gang - NO-NC contact</b> <input type="radio"/> White <input type="radio"/> Ivory
10	6 648 05	
10	6 647 08	<b>2 gang - NO-NC contact</b> <input type="radio"/> White <input type="radio"/> Ivory
10	6 648 08	
10	6 643 15	<b>1 gang-with label-holder - NO-NC contact</b> <input type="radio"/> White/ Ivory Supplied with claws, no LED Can be equipped with a 12 V or 230 V LED (p. 447) 
10	6 647 15	
10	6 647 26	<b>Illuminated</b> <input type="radio"/> White Supplied with LED 
10	6 648 26	
10	6 647 25	<b>IP 44 - NO-NC contact</b> Can be illuminated with Cat.No 6 650 90 or Cat.No 6 650 92 Mounts on standard plates <input type="radio"/> White <input type="radio"/> Ivory
10	6 648 25	

Pack	Cat.Nos	Multifunction switches
10	6 647 09	<b>2-way switch 10 AX + push-button 6 A - NO/NC contacts - 250 V~</b> <b>1 gang - NO-NC contact</b> <input type="radio"/> White <input type="radio"/> Ivory
10	6 648 09	

Multifunction switches video





6 651 14



6 651 18

Mechanisms supplied with cover plates and support frames  
To be equipped with plates (p. 451)  
Screw terminals  
Fixing with screws. Fixing with claws using accessory Cat.No 6 650 99 (p. 447)  
Supplied with site protection cover

Pack	Cat.Nos	<b>Dimmers 400 W - 2-wire</b>
1	6 651 14	<b>Facilitate the control and dimming of:</b> - 20 to 400 W incandescent, 230 V~ halogen - 40 to 400 VA ELV halogen bulbs with ferromagnetic transformer via electronic transformer Can be installed as a replacement for a traditional switch <b>Push dimmer</b> With on/off button and separate +/- button for dimming ○ White ● Ivory
1	6 652 14	
1	6 651 17	<b>Rotary dimmer</b> ○ White ● Ivory
1	6 652 17	
1	6 651 18	<b>Automatic switches - 2-wire</b> <b>Without neutral</b> Facilitate the control of 40 to 400 W incandescent, 230 V halogen and ELV halogen lamps via ferromagnetic or electronic transformer Can be installed as a replacement for a traditional switch Can be used as a two-way switch with push-button ○ White ● Ivory
1	6 652 18	
1	6 651 19	<b>Without neutral, for a time switch</b> For use with a modular time switch Enables automatic on/off switching, in a corridor or staircase, etc. Can be installed in replacement for a push-button The time-delay setting must be the same as for the time switch ○ White



6 651 01



6 651 11

Mechanisms equipped with cover plates and support frames  
To be equipped with plates (p. 451)

Pack	Cat.Nos	<b>Radio/ZigBee® switches</b>
1	6 651 01	<b>Centralized control units - transmitter switches</b> Surface-mounting or within a flush-mounting box No wiring required. Powered by 3V CR 2032 lithium batteries, supplied ○ White - Single switch Enables you to control a group of Radio/ZigBee® receiver switches
1	6 651 02	
1	6 651 03	<b>Individual unit - receiver switch 300 W</b> For installation in Batibox flush-mounting boxes min. depth 40 mm ○ White - Single switch - no neutral with status LED Enables you to control halogen and incandescent lamps
1	0 883 05	<b>Micromodule switch 300 W</b> Enables you to improve an existing installation by adding control points without damage to the walls Enables you to control energy-saving, LED, halogen and incandescent lamps To be installed near the lamp with neutral with Cat.No 0 306 54 (plug-in ceiling rose) for example Must be mounted with switches Cat.Nos 0 6 651 01/02 Phase/neutral power supply
1	6 651 11	<b>Radio/ZigBee® roller blind control</b> <b>Centralized control unit - transmitter switch</b> ○ White Allows you to raise/lower/stop a group of individual roller blind switches
1	6 651 12	<b>Individual unit - receiver switch</b> ○ White For direct motor control (4-wire) Phase/neutral power supply Preset function integrated into the switch

ZigBee®: ZigBee® certified product with Manufacturer Specific Profile

# Niloé™

## shutters, fan controls and key card switch



# Niloé™

## German standard socket outlets



6 647 11



6 647 91

Mechanisms supplied with cover plates and support frames  
To be equipped with plates (p. 451)  
Fixing with screws. Fixing with claws using accessory Cat.No 6 650 99 (p. 447)  
Supplied with site protection cover

Pack	Cat.Nos	Shutters and fan controls
10	6 647 11	<b>Automatic terminals</b> <b>Shutters control switch - 3 positions</b> 3-position switches "Raise - Stop - Lower" for direct motor control ○ White ● Ivory
10	6 648 11	
10	6 647 91	<b>Fan control switch - 2 positions</b> 2-position switches Low or high speed for direct control of a centralized mechanical ventilation system ○ White ● Ivory
10	6 648 91	
10	6 647 93	<b>Key card switch</b> Screw terminals To operate the room's electrical circuits (max. card length 54mm. Turns off 30 seconds after the card is removed) ○ White ● Ivory
10	6 648 93	



6 647 31



6 647 47

Mechanisms supplied with cover plates and support frames  
To be equipped with plates (p. 451)  
Fixing with screws. Fixing with claws using accessory Cat.No 6 650 99 (p. 447)  
Supplied with site protection cover

Pack	Cat.Nos	2P socket outlets with safety shutters
10	6 647 34	<b>Screw terminals</b> ○ White ● Ivory
10	6 648 34	
10	6 647 31	<b>German standard socket outlets with safety shutters</b> <b>2P+E - automatic terminals</b> ○ White ● Ivory
10	6 648 31	
10	6 647 32	<b>2P+E with flap cover - automatic terminals</b> ○ White ● Ivory
10	6 648 32	
10	6 647 47	<b>2P+E with flap cover - IP 44 - automatic terminals</b> Supplied with air permeability sock Cat.No 6 650 96 To be equipped with standard plates ○ White ● Ivory
10	6 648 47	
10	6 645 43	<b>2 x 2P+E compact - automatic terminals</b> Supplied complete with plate Supplied with claws Installation in 1 gang flush-mounting box Allows you to replace 1 socket with 2 sockets without changing the flush-mounting box ○ White - screw mounting ● Ivory - screw mounting
10	6 646 43	
10	6 647 46	<b>2 x 2P+E pre-wired - automatic terminals</b> To be equipped with 2 gang plate ○ White ● Ivory
10	6 648 46	



6 648 35



6 645 41

Mechanisms supplied with cover plates and support frames  
 To be equipped with plates (p. 451)  
 Fixing with screws. Fixing with claws using accessory Cat.No 6 650 99 (p. 447)  
 Supplied with site protection cover

Pack	Cat.Nos	French standard socket outlets with safety shutters
10	6 647 35	<b>2P+E - Automatic terminals</b> <ul style="list-style-type: none"> <li>○ White</li> <li>● Ivory</li> </ul>
10	6 648 35	
1	6 643 35	<ul style="list-style-type: none"> <li>○ White</li> </ul> Pack of 50, specially adapted for work sites
10	6 647 48	<b>2P+E - IP 44 - Automatic terminals</b> <ul style="list-style-type: none"> <li>○ White</li> <li>● Ivory</li> </ul>
10	6 648 48	
10	6 647 45	<b>2 x 2P+E pre-wired - Automatic terminals</b> For installation in 2-gang Batibox flush-mounting box <ul style="list-style-type: none"> <li>○ White</li> <li>● Ivory</li> </ul>
10	6 648 45	
10	6 645 41	<b>2 x 2P+E compact - screw terminals</b> Supplied complete with plate Supplied with claws Installation in 1 gang flush-mounting box Allows you to replace 1 socket with 2 sockets without changing the flush-mounting box <ul style="list-style-type: none"> <li>○ White</li> <li>● Ivory</li> </ul>
10	6 646 41	

Pack	Cat.Nos	Cable outlets
10	6 647 95	<b>Standard IP 21</b> Supplied with cover plate incorporating the plate One-gang installation <ul style="list-style-type: none"> <li>○ White</li> <li>● Ivory</li> </ul>
10	6 648 95	
10	6 651 95	<b>Mosaic and Arteor adaptors</b> Accept 2-module mechanisms (except special surface-mounting type) <ul style="list-style-type: none"> <li>○ White</li> <li>● Ivory</li> </ul>
10	6 652 95	
10	<b>N</b> 6 651 96	<b>Blanking plate</b> <ul style="list-style-type: none"> <li>○ White</li> </ul>



6 647 75

Mechanisms supplied with cover plates and support frames  
 To be equipped with plates (p. 451)  
 Fixing with screws. Fixing with claws using accessory Cat.No 6 650 99 (p. 447)  
 Supplied with site protection cover

Pack	Cat.Nos	Telephone sockets
10	6 647 69	<b>RJ 11 sockets</b> <ul style="list-style-type: none"> <li>○ White</li> <li>● Ivory</li> </ul>
10	6 648 69	
10	6 647 68	<b>T-shaped telephone sockets</b> <ul style="list-style-type: none"> <li>○ White</li> <li>● Ivory</li> </ul>
10	6 648 68	
10	6 647 70	<b>2 x RJ 11 sockets</b> <ul style="list-style-type: none"> <li>○ White</li> <li>● Ivory</li> </ul>
10	6 648 70	
10	6 647 75	<b>Data sockets</b> <b>Cat. 6 STP</b> 360° shielded sockets <ul style="list-style-type: none"> <li>○ White</li> <li>● Ivory</li> </ul>
10	6 648 75	
10	6 647 77	<b>Cat. 6 FTP</b> 9 contact socket <ul style="list-style-type: none"> <li>○ White</li> <li>● Ivory</li> </ul>
10	6 648 77	





6 647 60



6 647 63

Mechanisms supplied with cover plates and support  
 To be equipped with plates (p. 451)  
 Fixing with screws. Fixing with claws using accessory Cat.No 6 650 99  
 (p. 447)  
 Supplied with site protection cover  
 For Hertzian and satellite installation (with individual demodulator)  
 DTT and HDTV compatible  
 Shielded sockets  
 TV: male connector (Ø9.5 mm)  
 R: female connector (Ø9.5 mm)  
 SAT: "F" type connector  
 Recommended coaxial cable: 17/19 VATC

**TV-R-SAT sockets**

Pack	Cat.Nos	TV-R-SAT sockets
		TV: 5-68/120-862 MHz R: 87.5-108 MHz SAT: 550-2400 MHz
10	6 647 63	<b>Star 1.5 dB</b> <ul style="list-style-type: none"> <li>○ White</li> <li>● Ivory</li> </ul>
10	6 648 63	
10	6 645 64	<b>Terminal - 10 dB</b> <ul style="list-style-type: none"> <li>○ White</li> <li>● Ivory</li> </ul>
10	6 646 64	
10	6 645 65	<b>Passthrough - 14 dB</b> <ul style="list-style-type: none"> <li>○ White</li> <li>● Ivory</li> </ul>
10	6 646 65	

Pack	Cat.Nos	TV-R sockets
		TV: 5-68/120-862 MHz R: 87.5-108 MHz
10	6 647 60	<b>Star - 1.5 dB</b> <ul style="list-style-type: none"> <li>○ White</li> <li>● Ivory</li> </ul>
10	6 648 60	
10	6 645 62	<b>Terminal - 10 dB</b> <ul style="list-style-type: none"> <li>○ White</li> <li>● Ivory</li> </ul>
10	6 646 62	
10	6 645 61	<b>Passthrough - 14 dB</b> <ul style="list-style-type: none"> <li>○ White</li> <li>● Ivory</li> </ul>
10	6 646 61	

Pack	Cat.Nos	TV sockets
		TV: 0-2400 MHz
10	6 647 51	<b>Star 1.5 dB</b> <ul style="list-style-type: none"> <li>○ White</li> <li>● Ivory</li> </ul>
10	6 648 51	

Pack	Cat.Nos	TV sockets "F" type with screws
		SAT: 0-2400 MHz
10	6 647 50	<b>Star - 1.5 dB</b> <ul style="list-style-type: none"> <li>○ White</li> <li>● Ivory</li> </ul>
10	6 648 50	

Pack	Cat.Nos	Fibre optic sockets
		Equipped with 2 x SC/APC adaptors with protection cover
10	6 647 79	<ul style="list-style-type: none"> <li>○ White</li> <li>● Ivory</li> </ul>
10	6 648 79	



6 647 98



6 650 00

**Surface mounting boxes**

Pack	Cat.Nos	Surface mounting boxes
		Can be used horizontally or vertically DL PLUS input 20 x 15.5 mm, 32 x 12.5 mm 40 x 20 mm and Ø20 tube
10	6 647 98	<b>1-gang</b> Dimensions: 88.5 x 88.5 mm - height 40 mm <ul style="list-style-type: none"> <li>○ White</li> <li>● Ivory</li> </ul>
10	6 648 98	
5	6 647 99	<b>2-gang</b> Dimensions: 159.5 x 88.5 mm - height 40 mm <ul style="list-style-type: none"> <li>○ White</li> <li>● Ivory</li> </ul>
5	6 648 99	

**Accessories**

Pack	Cat.Nos	Accessories
100	6 650 99	<b>Claws</b> "Rapido" claws Enable you to mount devices undergoing renovation
10	6 650 90	<b>Monitor and indicator lights</b> Connection by direct mounting LED maintenance-free lamp 230 V indicator light Consumption 0.15 mA 
10	6 650 91	230 V monitor light Consumption 3 mA 
10	6 650 92	12 V - 24 V - 48 V indicator light 

**IP 44 plates**

Pack	Cat.Nos	IP 44 plates
		IP 44 and IK 07 provide standard Niloé functionality For exceptions: see the technical data sheet Cannot be surface mounted
10	6 650 00	<b>1-gang</b> <ul style="list-style-type: none"> <li>○ White</li> <li>● Ivory</li> </ul>
10	6 650 10	

 Plates see **p. 451**



**Niloé™**

Special for projects

# the essential

for all your projects

## SWITCHES



2-way switch



2-gang one-way switch

## TV & COMPUTERS



TV socket



RJ 45 Multimedia (telephone, data, TV)

## POWER SOCKETS



German standard socket outlet



Standard pre-wired double socket outlet German standard

## A MUST-HAVE PRODUCT FOR YOUR PROJECT WITH ESSENTIAL FUNCTIONALITY

**FLOW PACKAGING:** THE PROTECTION WHICH GUARANTEES DELIVERY OF AN EXCEPTIONAL QUALITY PRODUCT

■ Thanks to the flow packaging, your product is protected throughout the delivery process, right up until you mount it on the wall.

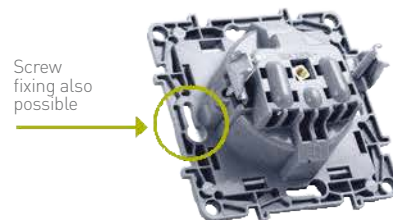

- MOUNTING CLIPS
- › Robust construction
- › Configuration adapted to all types of units



- SCREW TERMINALS

# Niloé™ special projects

switches and push-buttons



# Niloé™ special projects

German and French standard socket outlets



Mechanisms supplied with cover plates and support frames in an individual flow pack. To be equipped with plates (p. 451)  
 Flush-mounting or surface-mounting  
 Supplied with claws  
 Screw terminals

Mechanisms supplied with cover plates and support frames in an individual flow pack. To be equipped with plates (p. 451)  
 Flush-mounting or surface-mounting  
 Supplied with claws  
 Screw terminals

Pack	Cat.Nos	Switches 10 AX - 250 V~
		<b>One-way switch</b> Can be illuminated with kit rocker + LED Cat.No 6 645 23
20	6 645 00	○ White
20	6 646 00	● Ivory
		<b>2 gang one-way switch</b>
20	6 645 06	○ White
20	6 646 06	● Ivory
		<b>2 gang one-way switch with single live</b>
20	6 645 96	○ White
20	6 646 96	● Ivory
		<b>Two-way switch</b> Can be illuminated with kit rocker + LED Cat.No 6 645 23
20	6 645 20	○ White
20	6 646 20	● Ivory
		<b>Push-buttons 6 AX - 250 V~</b>
		<b>NO-NC push-button</b>
20	6 645 07	○ White
20	6 646 07	● Ivory
		<b>Illuminated push-button</b> Supplied with LED
20	6 645 22	○ White
20	6 646 22	● Ivory
		<b>Kit rocker + LED</b> To transform single command into illuminated command
10	6 645 23	○ White
10	6 646 23	● Ivory

Pack	Cat.Nos	2P sockets
20	6 645 38	○ White
20	6 646 38	● Ivory
		<b>German standard socket outlets</b>
		<b>2P+E socket</b>
20	6 645 39	○ White
20	6 646 39	● Ivory
		<b>2P+E socket with safety shutters</b>
20	6 645 29	○ White
20	6 646 29	● Ivory
		<b>2 x 2P+E (1-gang) sockets supplied with plate and cover plate</b>
10	6 645 44	○ White
10	6 646 44	● Ivory
		<b>French standard socket outlets</b>
		<b>2P+E socket</b>
20	6 645 40	○ White
20	6 646 40	● Ivory
		<b>2P+E socket with safety shutters</b>
20	6 645 27	○ White
20	6 646 27	● Ivory
		<b>2 x 2P+E (1-gang) sockets supplied with plate and cover plate</b>
10	6 645 42	○ White
10	6 646 42	● Ivory



6 645 52



6 645 69



6 646 71



6 647 98



6 650 00

Mechanisms supplied with cover plates and support frames in an individual flow pack. To be equipped with plates (p. 451)  
 Flush-mounting or surface-mounting  
 Supplied with claws  
 Screw terminals

Pack	Cat.Nos	Male TV sockets
20	6 645 52	TV: 0-2400 MHz
20	6 646 52	<b>Passthrough - 10 dB</b> ○ White ● Ivory
20	6 645 53	<b>Passthrough - 15 dB</b> ○ White ● Ivory
20	6 646 53	
20	6 645 54	<b>Passthrough - 20 dB</b> ○ White ● Ivory
20	6 646 54	
20	6 645 55	<b>Terminal - 5 dB</b> ○ White ● Ivory
20	6 646 55	
<b>Telephone, data sockets</b>		
20	6 645 69	<b>RJ 11</b> ○ White ● Ivory
20	6 646 69	
20	6 645 71	<b>RJ 45 - Cat. 5 UTP</b> ○ White ● Ivory
20	6 646 71	

Pack	Cat.Nos	Surface mounting boxes
10	6 647 98	Can be used horizontally or vertically DL PLUS input 20 x 15.5 mm, 32 x 12.5 mm 40 x 20 mm and Ø20 tube <b>1-gang</b> Dimensions: 88.5 x 88.5 mm - height 40 mm ○ White ● Ivory
10	6 648 98	
5	6 647 99	<b>2-gang</b> Dimensions: 159.5 x 88.5 mm - height 40 mm ○ White ● Ivory
5	6 648 99	
10	6 650 00	<b>IP 44 plates</b> IP 44 and IK 07 provide standard Niloé functionality For exceptions: see the technical data sheet Cannot be surface mounted 1-gang ○ White ● Ivory
10	6 650 10	
100	6 650 98	<b>Accessory</b> Protective shield Clips on to standard mechanisms. You can bend or open it to access the 2P+E socket.

**Niloé™**

plates



6 650 11

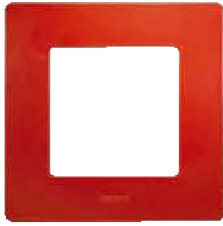

6 650 21



3 970 51

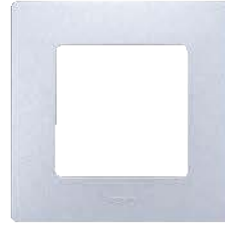

3 970 41





3 970 71

Pack	Cat.Nos	1-gang
20	6 650 01	 <ul style="list-style-type: none"> <li>○ White</li> <li>○ Ivory</li> <li>○ Taupe</li> <li>○ Red</li> <li>○ Plum</li> <li>○ Bronze</li> <li>○ Onyx</li> <li>○ Aluminium</li> <li>○ Cacao</li> <li>○ Dark wood</li> <li>○ Light wood</li> </ul>
20	6 650 11	
10	6 650 31	
10	6 650 21	
10	3 970 81	
10	3 970 31	
10	3 970 51	
10	3 970 41	
10	3 970 71	
10	3 970 91	
10	3 970 95	

Pack	Cat.Nos	2-gang
10	6 650 02	 <ul style="list-style-type: none"> <li>○ White</li> <li>○ Ivory</li> <li>○ Taupe</li> <li>○ Red</li> <li>○ Plum</li> <li>○ Bronze</li> <li>○ Onyx</li> <li>○ Aluminium</li> <li>○ Cacao</li> <li>○ Dark wood</li> <li>○ Light wood</li> </ul>
10	6 650 12	
10	6 650 32	
10	6 650 22	
10	3 970 82	
10	3 970 32	
10	3 970 52	
10	3 970 42	
10	3 970 72	
10	3 970 92	
10	3 970 96	

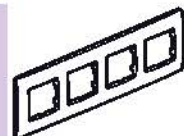
Pack	Cat.Nos	3-gang
5	6 650 03	 <ul style="list-style-type: none"> <li>○ White</li> <li>○ Ivory</li> <li>○ Taupe</li> <li>○ Red</li> <li>○ Plum</li> <li>○ Bronze</li> <li>○ Onyx</li> <li>○ Aluminium</li> <li>○ Cacao</li> <li>○ Dark wood</li> <li>○ Light wood</li> </ul>
5	6 650 13	
5	6 650 33	
5	6 650 23	
10	3 970 83	
10	3 970 33	
10	3 970 53	
10	3 970 43	
10	3 970 73	
10	3 970 93	
10	3 970 97	

Pack	Cat.Nos	4-gang
1	6 650 04	 <ul style="list-style-type: none"> <li>○ White</li> <li>○ Ivory</li> <li>○ Taupe</li> <li>○ Red</li> </ul>
1	6 650 14	
1	6 650 34	
1	6 650 24	
1	6 650 05	 <ul style="list-style-type: none"> <li>○ White</li> <li>○ Ivory</li> <li>○ Taupe</li> <li>○ Red</li> </ul>
1	6 650 15	
1	6 650 35	
1	6 650 25	

# Valena™

## switches



7 743 06 + 7 703 11



7 744 06 + 7 704 20



7 701 05 + 7 703 31



7 742 13 + 7 704 91



7 741 01 + 7 743 51

Mechanisms supplied with cover plates, to be equipped with plates (p. 463-465)  
Screw or claw mounting

Pack	Cat.Nos	Switches 10 AX - 250 V~
		Automatic terminals
		<b>One-way switch</b>
10	7 743 01	Ivory
10	7 744 01	White
10	7 701 01	Brilliant Aluminium
		<b>Two-way switch</b>
10	7 743 06	Ivory
10	7 744 06	White
10	7 701 06	Brilliant Aluminium
		<b>Intermediate switch</b>
10	7 743 07	Ivory
10	7 744 07	White
10	7 701 07	Brilliant Aluminium
		<b>Illuminated switch</b> Supplied with 0.5 mA - 230 V green lamp Cat.No 7 758 97
10	7 743 10	Ivory
10	7 744 10	White
10	7 701 10	Brilliant Aluminium
		<b>Two-way switch with indicator</b> Supplied with 1 mA - 230 V orange lamp Cat.No 7 758 98
10	7 743 25	Ivory
10	7 744 25	White
10	7 701 25	Brilliant Aluminium
		<b>Illuminated two-way switch</b> Supplied with 0.5 mA - 230 V green lamp Cat.No 7 758 97
10	7 743 26	Ivory
10	7 744 26	White
10	7 701 26	Brilliant Aluminium
		<b>Illuminated intermediate switch</b> Supplied with 0.5 mA - 230 V green lamp Cat.No 7 758 97
10	7 743 48	Ivory
10	7 744 48	White
10	7 701 48	Brilliant Aluminium
		<b>2 gang one-way switch</b>
10	7 743 05	Ivory
10	7 744 05	White
10	7 701 05	Brilliant Aluminium
		<b>2 gang two-way switch</b>
10	7 743 08	Ivory
10	7 744 08	White
10	7 701 08	Brilliant Aluminium
		<b>2 gang two-way switch with one indicator</b> Supplied with 1 mA - 230 V orange lamp Cat.No 7 758 98
10	7 743 45	Ivory
10	7 744 45	White
10	7 701 45	Brilliant Aluminium
		<b>Illuminated 2 gang one-way switch</b> Supplied with 1 mA - 230 V green lamp Cat.No 7 758 97
10	7 743 28	Ivory
10	7 744 28	White
10	7 701 28	Brilliant Aluminium

Pack	Cat.Nos	Switches 10 AX - 250 V~ (continued)
		<b>2 gang one-way switch with two indicators</b> Supplied with 1 mA - 230 V orange lamp Cat.No 7 758 98
10	7 741 13	Ivory
10	7 742 13	White
10	7 702 13	Brilliant Aluminium
		<b>Illuminated 2 gang two-way switch</b> Supplied with 0.5 mA - 230 V green lamp Cat.No 7 758 97
10	7 741 12	Ivory
10	7 742 12	White
10	7 702 12	Brilliant Aluminium
		<b>Double pole switch</b>
10	7 743 02	Ivory
10	7 744 02	White
10	7 701 02	Brilliant Aluminium
		<b>Double pole switch with indicator</b> Supplied with 1 mA - 230 V orange lamp Cat.No 7 758 98
10	7 743 49	Ivory
10	7 744 49	White
10	7 701 49	Brilliant Aluminium
		<b>Switches 10 AX - 250 V~ - IP 44</b>
		Automatic terminals
		<b>One-way switch</b>
10	7 741 01	Ivory
10	7 742 01	White
		<b>Two-way switch</b>
10	7 741 06	Ivory
10	7 742 06	White
		<b>Intermediate switch</b>
10	7 741 97	Ivory
10	7 700 97	White
		<b>2 gang two-way switch</b>
10	7 741 98	Ivory
10	7 700 98	White
		<b>Double pole switch</b>
10	7 741 92	Ivory
10	7 700 92	White

# Valena™

## switches (continued)



7 741 04 + 7 703 01



7 742 14 + 7 704 71

Mechanisms supplied with cover plates, to be equipped with plates (p. 463-465) - Screw or claw mounting

Pack	Cat.Nos	Switches 16 AX - 250 V~
		Automatic terminals
		<b>Two-way switch</b>
10	7 741 05	Ivory
10	7 742 05	White
10	7 702 05	Brilliant Aluminium
		<b>Illuminated two-way switch</b>
		Supplied with 0.5 mA - 230 V green lamp Cat.No 7 758 97
10	7 741 03	Ivory
10	7 742 03	White
10	7 702 03	Brilliant Aluminium
		<b>Double pole switch</b>
10	7 741 04	Ivory
10	7 742 04	White
10	7 702 04	Brilliant Aluminium
		<b>Double pole switch with indicator</b>
		Supplied with 1 mA - 230 V orange lamp Cat.No 7 758 98
10	7 741 14	Ivory
10	7 742 14	White
10	7 702 14	Brilliant Aluminium
		<b>3-pole switches 10 A - 400 V~</b>
		Automatic terminals
		<b>For fluorescent tubes</b>
10	7 743 03	Ivory
10	7 744 03	White
10	7 701 03	Brilliant Aluminium

# Valena™

## push-buttons



7 743 12 + 7 743 51



7 701 13 + 7 703 51



7 744 19  
+ 7 744 51

Mechanisms supplied with cover plates, to be equipped with plates (p. 463-465) - Screw or claw mounting

Pack	Cat.Nos	Push-buttons 10 A - 250 V~
		Automatic terminals
		<b>Push-button</b>
10	7 743 11	Ivory
10	7 744 11	White
10	7 701 11	Brilliant Aluminium
		<b>Push-button with lamp symbol</b>
10	7 743 12	Ivory
10	7 744 12	White
10	7 701 12	Brilliant Aluminium
		<b>Push-button with bell symbol</b>
10	7 741 16	Ivory
10	7 742 16	White
10	7 702 16	Brilliant Aluminium
		<b>Illuminated push-button with lamp symbol</b>
		Supplied with 1 mA - 230 V green lamp Cat.No 7 758 90
10	7 743 13	Ivory
10	7 744 13	White
10	7 701 13	Brilliant Aluminium
		<b>Illuminated push-button with bell symbol</b>
		Supplied with 1 mA - 230 V green lamp Cat.No 7 758 90
10	7 741 15	Ivory
10	7 742 15	White
10	7 702 15	Brilliant Aluminium
		<b>Double changeover push-button</b>
1	7 741 18	Ivory
1	7 742 18	White
1	7 702 18	Brilliant Aluminium
		<b>Changeover push-button for pull cord control</b>
1	7 743 19	Ivory
1	7 744 19	White
1	7 701 19	Brilliant Aluminium
		<b>Push-buttons 10 A - 250 V~ - IP 44</b>
		<b>Push-button with bell symbol</b>
10	7 741 99	Ivory
10	7 700 99	White
		<b>Push-buttons 10 A - 12 V~</b>
		Automatic terminals
		<b>Illuminated push-button with bell symbol</b>
		Supplied with 15 mA - 8-12 V green lamp Cat.No 7 758 99
10	7 743 15	Ivory
10	7 744 15	White
10	7 701 15	Brilliant Aluminium
		<b>Illuminated push-button with label-holder</b>
		Supplied with 15 mA - 8-12 V green lamp Cat.No 7 758 99
10	7 741 17	Ivory
10	7 742 17	White
10	7 702 17	Brilliant Aluminium
		<b>Accessory</b>
10	0 898 05	Pull-cord accessory 1.5 m length



7 700 89 + 7 744 51



7 700 74 + 7 744 61

Mechanisms supplied with cover plates, to be equipped with plates (p. 463-465) - Screw or claw mounting

Pack	Cat.Nos	Automatic switches with movement detector
		230 V~ - 50/60 Hz Luminosity threshold: 3 to 1000 lux
		<b>Standard</b> 60-300 W for incandescent and halogen lamps 230 V~ Temporization: 6 seconds to 6 min. Can replace a switch without additional wiring Detection angle: 130°
1	7 741 28	Ivory
1	7 742 28	White
1	7 702 28	Brilliant Aluminium
		<b>With override, with neutral</b> 1000 W for incandescent and halogen lamps 230 V~ 500 VA ELV lamps with electronic or ferromagnetic transformers, fluorescent tubes and compact lamps 100 VA fans Temporization: 1 second to 16 min Detection angle: 180° Can be remotely controlled via non-illuminated push-button
1	7 741 89	Ivory
1	7 700 89	White
1	7 702 89	Brilliant Aluminium
		<b>Dimmers 230 V~ - 50 Hz</b>
		<b>Rotary dimmer</b> Push to On/Off function Rotate for light level adjustment 100-1000 W for incandescent and halogen lamps 230 V~ 1000 VA ELV lamps with ferromagnetic transformers
1	7 741 60	Ivory
1	7 700 60	White
1	7 702 60	Brilliant Aluminium
		<b>Rotary adjustment and control</b> 40-400 W for incandescent and halogen lamps 230 V~ 40-400 VA ELV lamps with ferromagnetic transformers
1	7 741 61	Ivory
1	7 700 61	White
1	7 702 61	Brilliant Aluminium
		<b>Push-button dimmer - 40-400 W</b> With an On/Off button and a separate + / - button for dimming 40-400 W for incandescent and halogen lamps 230 V~ 40-400 VA ELV halogen lamps with electronic and ferromagnetic transformers Can be remotely controlled via non-illuminated push-button or two-way switch
1	7 741 62	Ivory
1	7 700 62	White
1	7 702 62	Brilliant Aluminium
		<b>Push-button dimmer - 40-600 W</b> With an On/Off button and a separate + / - button for dimming 40-600 W for incandescent and halogen lamps 230 V~ 40-600 VA ELV halogen lamps with ferromagnetic transformers
1	7 741 74	Ivory
1	7 700 74	White
1	7 702 74	Brilliant Aluminium



7 743 04 + 7 703 11



7 741 35 + 7 700 20



7 741 26 + 7 743 51

Mechanisms supplied with cover plates, to be equipped with plates (p. 463-465) - Screw or claw mounting

Pack	Cat.Nos	Roller blinds control 10 A - 250 V~
		Automatic terminals
		<b>Switch with mechanical interlock</b>
1	7 743 04	Ivory
1	7 744 04	White
1	7 701 04	Brilliant Aluminium
		<b>Push-button with electrical interlock</b>
1	7 743 14	Ivory
1	7 744 14	White
1	7 701 14	Brilliant Aluminium
		<b>Keycards for hotel rooms</b>
		For energizing a circuit by inserting a card Example of use: hotel room power supply only when the guest is present 230 V~ - 50/60 Hz
		<b>Standard</b> Compatible with a smart card for hotel room max. width 54 mm
10	7 741 34	Ivory
10	7 742 34	White
10	7 702 34	Brilliant Aluminium
		<b>With time delay</b> Compatible with a smart card for hotel room max. width 54 mm or a key fob Cat.No 0 898 06 (p. 504) Aprox 30 sec. after card removal
1	7 741 35	Ivory
1	7 742 35	White
1	7 702 35	Brilliant Aluminium
		<b>Thermostats</b>
		<b>Standard</b> NO/NC contact to control heating or air-conditioning
1	7 741 26	Ivory
1	7 742 26	White
1	7 702 26	Brilliant Aluminium
		<b>Comfort with switch</b> Comfort/reduce, manual or automatic with auxiliary input 230 V~
1	7 741 27	Ivory
1	7 742 27	White
1	7 702 27	Brilliant Aluminium
		<b>For floor heating system</b> Comfort mode reduced with auxiliary input 230 V~ Supplied with floor sensor, length 20 m
1	7 741 91	Ivory
1	7 700 91	White
1	7 702 91	Brilliant Aluminium
		<b>Thermostat probe</b> Length 20 m
1	7 700 93	



# Valena™

## television sockets



7 701 36 + 7 703 91



7 744 32 + 7 744 51



7 743 29 + 7 703 01



7 743 42

Mechanisms supplied with cover plates, to be equipped with plates (p. 463-465)  
Screw or claw mounting

For Hertzian and satellite installation (with individual demodulator)

DTT and HDTV compatible. Shielded sockets

TV: male connector (Ø9.5 mm)

R: female connector (Ø9.5 mm)

SAT: "F" type connector

Recommended coaxial cable: 17/19 VATC

Pack	Cat.Nos	TV-R-SAT sockets
		TV: 5-68/120-862 MHz R: 87.5-108 MHz SAT: 550-2400 MHz
		<b>Star socket - 1.5 dB</b>
10	7 743 35	Ivory
10	7 744 35	White
10	7 701 35	Brilliant Aluminium
		<b>Terminal socket - 10 dB</b>
10	7 743 36	Ivory
10	7 744 36	White
10	7 701 36	Brilliant Aluminium
		<b>Passthrough socket - 14 dB</b>
10	7 743 37	Ivory
10	7 744 37	White
10	7 701 37	Brilliant Aluminium
		<b>TV-R-SAT 2 cables - 1.5 dB</b>
		Possible to add satellite on existing installation without connection, just need a second cable to the socket
10	7 704 10	White
10	7 741 10	Ivory
10	7 702 10	Brilliant Aluminium
		<b>TV-R central plates</b>
		30 mm with screw for adaptation to local manufacturers such as DX Contera, Televes and Hirschmann
10	7 743 42	Ivory
10	7 744 42	White
10	7 701 42	Brilliant Aluminium

Pack	Cat.Nos	TV-R sockets
		TV: 5-68/120-862 MHz R: 87.5-108 MHz
		<b>Star socket - 1.5 dB</b>
10	7 743 32	Ivory
10	7 744 32	White
10	7 701 32	Brilliant Aluminium
		<b>Terminal socket - 10 dB</b>
10	7 743 33	Ivory
10	7 744 33	White
10	7 701 33	Brilliant Aluminium
		<b>Passthrough socket - 14 dB</b>
10	7 743 34	Ivory
10	7 744 34	White
10	7 701 34	Brilliant Aluminium
		<b>TV sockets</b>
		TV: 0-2400 MHz
		<b>Star socket - 1.5 dB</b>
10	7 743 29	Ivory
10	7 744 29	White
10	7 701 29	Brilliant Aluminium
		<b>Terminal socket - 10 dB</b>
10	7 743 30	Ivory
10	7 744 30	White
10	7 701 30	Brilliant Aluminium
		<b>Passthrough socket - 14 dB</b>
10	7 743 31	Ivory
10	7 744 31	White
10	7 701 31	Brilliant Aluminium

# Valena™

## data sockets



7 741 44 + 7 743 51



7 702 39 + 7 703 71

Mechanisms supplied with cover plates, to be equipped with plates (p. 463-465) - Screw or claw mounting  
Fast connection sockets – no tool required  
Contacts marked with double colour codes

Pack	Cat.Nos	Data sockets Cat. 6
10	7 741 46	<b>RJ 45 UTP - 1 outlet</b>
10	7 741 42	● Ivory
10	7 742 46	○ Ivory - without claws
10	7 742 42	○ White
10	7 742 42	○ White - without claws
10	7 702 46	● Brilliant Aluminium
10	7 702 42	● Brilliant Aluminium - without claws
10	7 741 47	<b>RJ 45 UTP - 2 outlets</b>
10	7 741 43	● Ivory
10	7 742 47	○ Ivory - without claws
10	7 742 43	○ White
10	7 742 43	○ White - without claws
10	7 702 47	● Brilliant Aluminium
10	7 702 43	● Brilliant Aluminium - without claws
10	7 741 32	<b>RJ 45 FTP - 1 outlet - without claws</b>
10	7 742 32	● Ivory
10	7 702 32	○ White
		● Brilliant Aluminium
10	7 741 33	<b>RJ 45 FTP - 2 outlets - without claws</b>
10	7 742 33	● Ivory
10	7 702 33	○ White
		● Brilliant Aluminium
10	7 741 44	<b>RJ 45 STP - 1 outlet - without claws</b>
10	7 742 44	● Ivory
10	7 702 44	○ White
		● Brilliant Aluminium
10	7 741 45	<b>RJ 45 STP - 2 outlets - without claws</b>
10	7 742 45	● Ivory
10	7 702 45	○ White
		● Brilliant Aluminium

Pack	Cat.Nos	Data sockets Cat. 5e
10	7 741 30	<b>RJ 45 UTP - 1 outlet</b>
10	7 741 38	● Ivory
10	7 742 30	○ Ivory - without claws
10	7 742 38	○ White
10	7 702 30	○ White - without claws
10	7 702 30	● Brilliant Aluminium
10	7 702 38	● Brilliant Aluminium - without claws
10	7 741 31	<b>RJ 45 UTP - 2 outlets</b>
10	7 741 39	● Ivory
10	7 742 31	○ Ivory - without claws
10	7 742 39	○ White
10	7 702 31	○ White - without claws
10	7 702 31	● Brilliant Aluminium
10	7 702 39	● Brilliant Aluminium - without claws

# Valena™

## telephone sockets



7 744 38 + 7 744 51



7 702 80 + 7 703 31

Mechanisms supplied with cover plates, to be equipped with plates (p. 463-465) - Screw or claw mounting

Pack	Cat.Nos	Telephone sockets
		Sockets equipped with quick-fit 1/4 turn self-stripping connectors linkage
10	7 743 38	<b>RJ 11 - 4 contacts - 1 outlet</b>
10	7 744 38	● Ivory
10	7 701 38	○ White
		● Brilliant Aluminium
10	7 743 39	<b>RJ 11 - 4 contacts - 2 outlets</b>
10	7 744 39	● Ivory
10	7 701 39	○ White
		● Brilliant Aluminium
1	7 743 41	<b>RJ 45 - ISDN / Internet - 8 contacts</b>
1	7 744 41	1 output
1	7 701 41	● Ivory
		○ White
		● Brilliant Aluminium
10	7 741 80	<b>Twin socket RJ 45 Cat 6 UTP + RJ 11</b>
10	7 700 80	Without claws
10	7 702 80	● Ivory
		○ White
		● Brilliant Aluminium

# Valena™

## audio/video sockets



7 743 24 + 7 743 51



7 702 82 + 7 703 51

Mechanisms supplied with cover plates, to be equipped with plates (p. 463-465) - Screw or claw mounting

Pack	Cat.Nos	<b>Loudspeaker sockets</b>
		Equipped with DIN 41 529 standard connectors For 0.75 to 5 mm <sup>2</sup> cables Screw terminals
		<b>Single loudspeaker socket</b>
10	7 741 23	Ivory
10	7 742 23	White
10	7 702 23	Brilliant Aluminium
		<b>Double loudspeaker socket</b>
10	7 743 24	Ivory
10	7 744 24	White
10	7 701 24	Brilliant Aluminium
		<b>Audio and video sockets</b>
		<b>Audio/video socket HDMI</b> HDMI audio/video type A socket Used to transmit High-definition digital audio/video streams between a source (HD-DVD or Blu-Ray drive, games console, computer, etc) and a compatible receiver (TV, video projector)
1	7 741 85	Ivory
1	7 700 85	White
1	7 702 85	Brilliant Aluminium
		<b>Video socket HD 15</b> For the VGA, XGA or VESA connection of a PC monitor, TV, video projector
1	7 741 83	Ivory
1	7 700 83	White
1	7 702 83	Brilliant Aluminium
		<b>Triple RCA socket</b> For the composite video and stereo audio connection of any amplifier, DVD drive, VCR type peripheral
1	7 741 84	Ivory
1	7 700 84	White
1	7 702 84	Brilliant Aluminium
		<b>HD 15 + 3.5 mm Jack sockets</b>
1	7 741 82	Ivory
1	7 700 82	White
1	7 702 82	Brilliant Aluminium

# Valena™

## equipment for audio/video sockets



0 517 20



0 517 22



0 779 30

Pack	Cat.Nos	<b>Equipment cords</b>
		For connecting a socket to a terminal
		<b>HDMI 1.4 cord</b> Length 10 m For connecting an HDMI socket to the audio/video terminal (plasma screen, DVD drive, Home Cinema, games console, etc) For use at more than 10 m, use the HDMI Booster Cat.No 0 779 30
1	0 517 20	
		<b>HD 15 + 3.5 mm Jack cord</b> Length 2 m For connecting an HD 15 video socket and a 3.5 mm audio jack to a terminal (PC, video projector)
1	0 517 22	
		<b>HDMI booster</b> Used to extend an HDMI connection Consists of 2 female connectors and used as an addition to the HDMI cord (for example cord Cat.No 0 517 20) Does not need an external power supply
1	0 779 30	
		<b>Cables</b>
		For connecting 2 sockets
		<b>HDMI cable</b> Length 20 m For connecting HDMI sockets at a distance of up to 10 m
1	0 327 80	
		<b>VGA cable</b> Length 20 m For connecting full pin HD 15 sockets at a distance of up to 20 m
1	0 327 81	



7 743 16 + 7 743 51



7 744 21 + 7 744 51



7 743 27 + 7 701 51



7 702 11 + 7 703 71

Mechanisms supplied with cover plates, to be equipped with plates (p. 498-499)  
 Screw or claw mounting  
 IP 2 protection index  
 Terminals: 2.5 mm<sup>2</sup>

Pack	Cat.Nos	2P socket outlets 10/16 A - 250 V~
10	7 743 16	<b>Screw terminals</b> ● Ivory
10	7 744 16	○ White
10	7 701 16	● Brilliant Aluminium
		<b>German standard socket outlets 10/16 A - 250 V~</b>
		<b>2P+E - automatic terminals with shutters</b>
10	7 741 22	● Ivory
10	7 742 22	○ White
10	7 702 11	● Brilliant Aluminium
		<b>2P+E - screw terminals</b>
10	7 743 20	● Ivory
10	7 744 20	○ White
10	7 701 20	● Brilliant Aluminium
		<b>2P+E with shutters for child protection - screw terminals</b>
10	7 743 21	● Ivory
10	7 744 21	○ White
10	7 701 21	● Brilliant Aluminium
		<b>2P+E with flap - screw terminals</b>
10	7 743 22	● Ivory
10	7 744 22	○ White
10	7 701 22	● Brilliant Aluminium
		<b>2P+E with mechanical ejecting system for plug - screw terminals</b>
5	7 743 95	● Ivory
5	7 743 94	○ White
5	7 701 94	● Brilliant Aluminium
		<b>2P+E with coloured cover plate - screw terminals</b>
10	7 743 27	● Red with tamperproof
10	7 743 72	● Green
10	7 743 73	● Orange
		<b>2P+E supplied complete</b> With cover plate and plate
10	7 743 23	● Ivory - screw terminals
10	7 741 19	● Ivory - automatic terminals
10	7 744 23	○ White - screw terminals
10	7 742 19	○ White - automatic terminals
10	7 701 23	● Brilliant Aluminium - screw terminals
10	7 702 19	● Brilliant Aluminium - automatic terminals

Pack	Cat.Nos	German standard socket outlets 16 A - 250 V~ - IP 44
		<b>2P+E with flap and shutters for child protection - screw terminals</b>
10	7 741 20	● Ivory
10	7 742 20	○ White
		<b>2P+E key protected with flap - screw terminals</b>
1	7 742 60	○ White Delivered with accessory Cat.No 7 759 99
		<b>French standard socket outlets 10/16 A - 250 V~</b>
		<b>2P+E - screw terminals</b>
10	7 743 98	● Ivory
10	7 743 96	○ White
10	7 701 96	● Brilliant Aluminium
		<b>2P+E with shutters for child protection - screw terminals</b>
10	7 743 99	● Ivory
10	7 743 97	○ White
10	7 701 97	● Brilliant Aluminium
		<b>2P+E with red cover plate - screw terminals</b>
10	7 700 90	● Red with tamperproof
		<b>French standard socket outlets 16 A - 250 V~ - IP 44</b>
		<b>2P+E with flap and shutters for child protection - screw terminals</b>
10	7 741 21	● Ivory
10	7 742 21	○ White

# Valena™

## USB chargers



# Valena™

## USB chargers



7 704 70 + 7 744 51



0 803 99

Pack Cat.Nos **USB chargers, 2 USB 1500 mA**

Conforms to standard IEC 62684-2011-01  
 For charging mobile phones, tablet PCs, smartphones, MP3 and MP4 players quickly  
 Frees up a socket recess  
 Consumption in passive mode < 0.1 W CLASS II SELV  
 Conforms to the EEC directive on harmonisation of the charging standard for portable terminals and the reduction of mobile phone chargers  
 For installation in flush-mounting box depth 40 mm minimum  
 Tap-off connection possible on 2P+E socket  
 Supplied cordless



- 1 7 704 70
- 1 7 741 70
- 1 7 702 70



- White
- Ivory
- Brilliant Aluminium

**Support for smartphone**

- 10 0 803 99



Supplied with 60 cm USB/micro USB retractable cord  
 For charging and synchronisation with PC  
 Resistance > 7500 operations  
 Fixing using screws or adhesive on all surfaces  
 Has a non-slip coating to prevent phones falling off  
 The phone's screen can be seen while charging

**Average charge time for a smartphone with a 1500 mA charger**

Brand	Smartphone	Average charge time 80 %	Average charge time 100 %
RIM	Blackberry Torch 9810	01h01	01h23
Apple	iPhone 3GS	01h04	02h07
Apple	iPhone 4S	01h14	01h56
Apple	iPhone 5	01h14	02h20
Motorola	Defy - MB525 - Jordan	01h13	01h47
Nokia	Lumia 800 - Sea Ray	01h39	02h33
Samsung	Galaxy S III - 19300	01h47	02h43
Samsung	Galaxy S IV	02h00	02h59
Sony	XPERIA S - LT26i - Arc HD Nozomi	01h20	02h05
		average < 1h15	average < 2h

**Application examples**

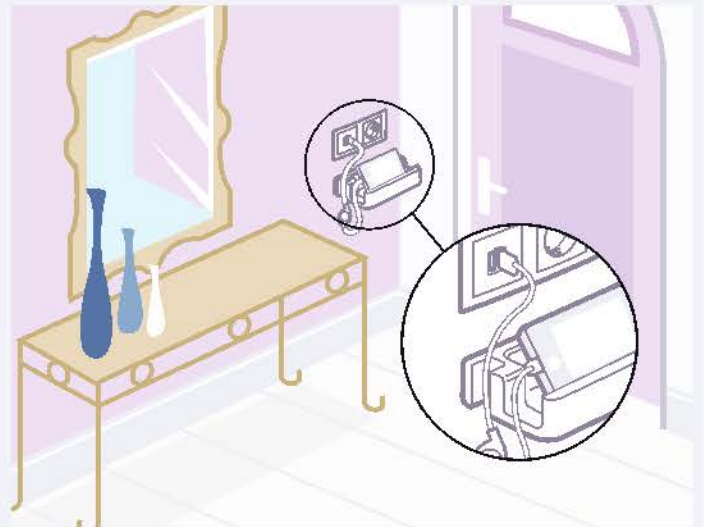

Installed in the hall, the USB charger provides quick, easy to find, always available charging as soon as you get home (no more lost chargers cluttering up the house)

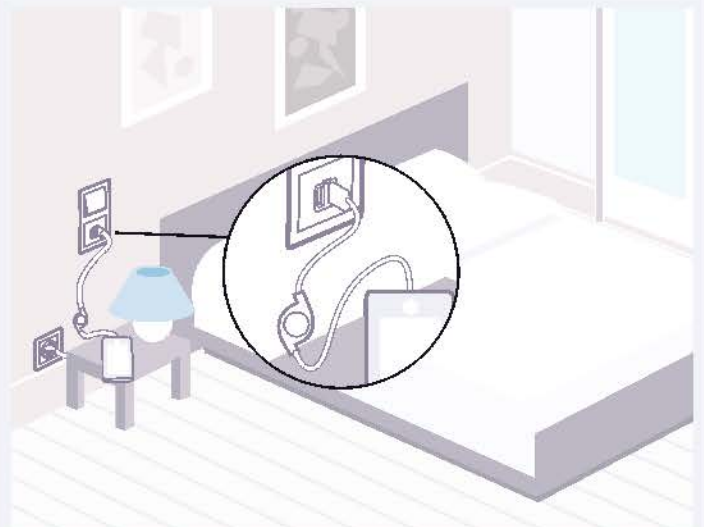

Installed beside the bed, the USB charger powers the mobile during the night without using a 2P+E socket

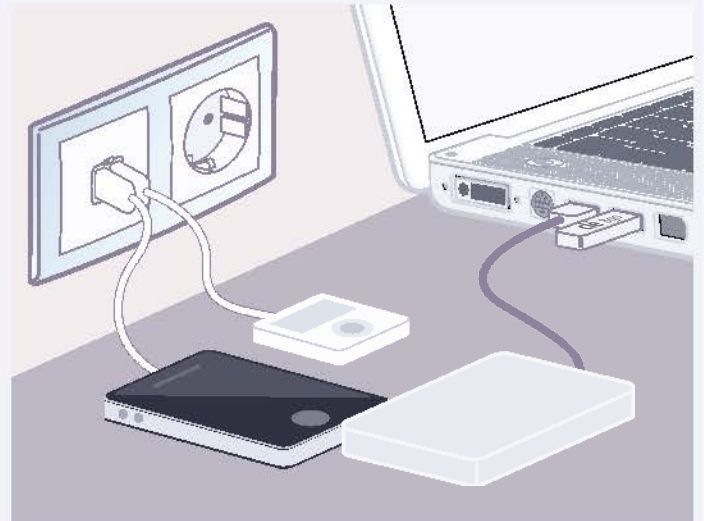

Installed near the PC, the USB charger frees up the USB ports on my terminal and avoids me having to start it up

# Valena™

complete sockets outlets



7 743 71



2 x 7 742 02 + 7 742 07

Mechanisms supplied with cover plates  
Screw or claw mounting

Pack	Cat.Nos	
		<b>German standard double socket outlets 16 A - 250 V~</b>
		Flush-mounting in 1 gang Ø60 mm boxes Supplied complete with cover plate and plate
		<b>2 x 2P+E - screw terminals</b>
5	7 743 70	● Ivory
5	7 744 00	○ White
5	7 701 00	● Brilliant Aluminium
		<b>2 x 2P+E with shutters for child protection</b>
5	7 743 71	● Ivory - screw terminals
5	7 744 27	○ White - screw terminals
5	7 742 48	○ White - automatic terminals
5	7 701 27	● Brilliant Aluminium - screw terminals
		<b>French standard double socket outlets 16 A - 250 V~</b>
		Flush-mounting in 1 gang Ø60 mm boxes Supplied complete with cover plate and plate
		<b>2 x 2P+E - screw terminals</b>
5	7 743 92	● Ivory
5	7 743 90	○ White
5	7 702 90	● Brilliant Aluminium
		<b>2 x 2P+E with shutters for child protection</b>
5	7 743 93	● Ivory
5	7 743 91	○ White
5	7 701 91	● Brilliant Aluminium
		<b>Nordic countries socket outlets 16 A - 250 V~</b>
		<b>2 x 2P+E with shutters for child protection - automatic terminals</b>
5	7 742 02	○ White
		<b>Special plate</b>
5	7 742 07	2 gang
		<b>Special adaptor</b>
10	7 742 10	For single sockets, RJ 45 sockets and TV-R-SAT sockets

# Valena™

accessories



7 743 47 + 7 743 51



7 744 50

Pack	Cat.Nos	
		<b>Cable outlets</b>
10	7 743 47	● Ivory
10	7 744 47	○ White
10	7 701 47	● Brilliant Aluminium
		<b>Blanking plates</b>
10	7 743 46	● Ivory
10	7 744 46	○ White
10	7 701 46	● Brilliant Aluminium
		<b>Universal plates 46.5 mm</b>
10	7 743 80	● Ivory
10	7 744 80	○ White
10	7 701 80	● Brilliant Aluminium
		<b>Weatherproof plates - IP 44</b>
		Compatible with any non IP 44 mechanisms, for 1 gang installation only IP 44 plate with flap
10	7 743 50	● Ivory
10	7 744 50	○ White
10	7 701 50	● Brilliant Aluminium
		<b>Accessory</b>
1	7 759 99	<b>Key protection for German standard socket outlet</b> Accessory for key protection
		<b>Mounting accessories</b>
		<b>Surface-mounting box</b>
10	7 761 31	● Ivory
10	7 761 81	○ White
		<b>Accessory for adapting cables and tubes</b>
10	7 761 34	● Ivory
10	7 761 84	○ White
		<b>Combination accessory</b>
		For multiple vertical assemblies of surface boxes
10	7 761 35	● Ivory
10	7 761 85	○ White
		<b>Replacement lamps</b>
10	7 758 97	0.5 mA - 230 V - Green
10	7 758 98	1 mA - 230 V - Orange
10	7 758 99	15 mA - 12 V~ - Green
10	7 758 90	1 mA - 230 V - Green

# Valena™

## sound diffusion



7 700 70 + 7700 69 + 7701 52













7 741 67 + 7 741 68 + 7 743 52

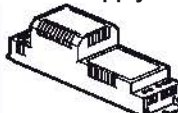

7 700 71 + 7 701 51

Mechanisms supplied with cover plates, to be equipped with plates (p. 463-465)  
Screw or claw mounting

Pack	Cat.Nos	Single zone sound diffusion	Pack	Cat.Nos	Multi-zone sound diffusion (continued)
1	7 700 69	<b>Tuner</b>  Power supply 15 V <sub>DC</sub> Manual or automatic selection of stations 10-station memory Integrated aerial (adjustable reception sensitivity) On/off control Volume control Equipped with an auxiliary input for connecting an MP3 player or Discman (3.5 mm Jack socket), cord not supplied Compatible with 4/8 or 16 Ω Stereo or mono output Grey cover plate			<b>Tuner extension and intercom</b> Used together with the local control and with no additional wiring, the extension can be used to distribute radio on one control unit Automatic or manual search Intercom function (call to one room or a set of rooms, call takes priority over music distribution) Baby monitoring function Simplified access to local control functions via dedicated switches  <ul style="list-style-type: none"> <li>● Ivory</li> <li>○ White</li> <li>● Brilliant Aluminium</li> </ul>
1	7 700 70	<b>Power supply for tuner with integrated loudspeaker</b>  Used together with tuner Cat.No 7 700 69, it can distribute radio or the music source Loudspeaker power 1 W - 16 Ω Grey cover plate			<b>Loudspeakers</b> <b>Flush-mounting loudspeaker</b> Max. power 2 W - 16 Ω - 2"  <ul style="list-style-type: none"> <li>● Ivory</li> <li>○ White</li> <li>● Grey</li> </ul>
1	0 673 22	<b>Power supply in false ceiling for tuner</b>  Power supply 230 V <sub>AC</sub> Output 15 V <sub>DC</sub> - 3.5 W For use in Plexo box Cat.No 0 920 52			<b>False ceiling mounting spot loudspeaker</b>  White Depth 27 mm Ø hole: 65 mm Visible depth: 11 mm Power: 2 W - 16 Ω - 2" Equipped with clips for attachment Use a Ø65 mm crown saw to cut the hole
		<b>Multi-zone sound diffusion</b> <b>Source input with modular power supply</b> Used to connect the main music source (Hi-Fi, computer, etc.) via Ø3.5 mm jack socket (cord not supplied) The source input powers local controls Cat.No 7 741 67 to distribute music in the rooms of a house (1 local control per room) Supplied with 15 V - 60 W modular power supply, size 4.5 DIN modules			<b>False ceiling mounting invisible loudspeaker</b>  For multi-zone sound distribution Can be connected with the 15 V - 60 W power supply supplied with source input Max. power 8 W Depth: 98 mm Supplied with adhesive and gluing template
1	7 741 66	 <ul style="list-style-type: none"> <li>● Ivory</li> <li>○ White</li> <li>● Brilliant Aluminium</li> </ul>			<b>Standard flush-mounting loudspeaker</b>  White Power: 100 W - 8 Ω - 6.5" Ø hole: 198 mm Depth: 85 mm
1	7 700 66				
1	7 702 66				
		<b>Local control</b> Equipped with an LCD screen, used to select the music source: main (Hi-Fi) or local (e.g.: MP3 player) via cord with Ø3.5 mm jack (not supplied) Stereo output 2 x 1.5 W Volume, balance, bass/treble and loudness controls Time display Integrated alarm clock function (by beep or music) General call function from all local controls with answer possible from the person called (microphone integrated in the product) Compatible with 4-8 or 16 Ω			
1	7 741 67	 <ul style="list-style-type: none"> <li>● Ivory</li> <li>○ White</li> <li>● Brilliant Aluminium</li> </ul>			
1	7 700 67				
1	7 702 67				

■ Diffusion of a music source in one room in a house (for example the kitchen, bathroom, etc.)

With spot loudspeakers Cat.No 0 673 27 and power supply Cat.No 7 700 69 (stereo)

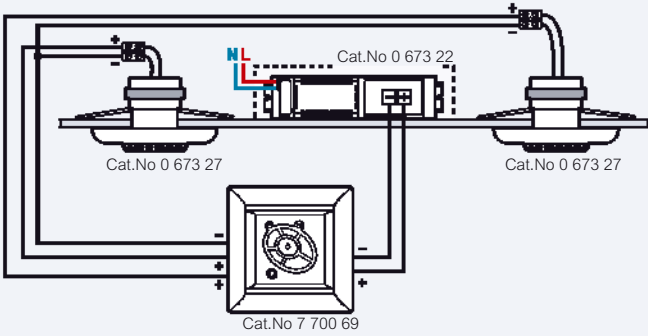

With power supply for tuner Cat.No 7 700 69 + integrated loudspeaker Cat.No 7 700 70 (mono)

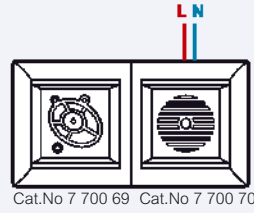

■ Diffusion of a music source in all the rooms in a house

Diffusion of the main source or independent auxiliary (MP3 player) via local control Cat.Nos 7 741 67/7 700 67/7 702 67

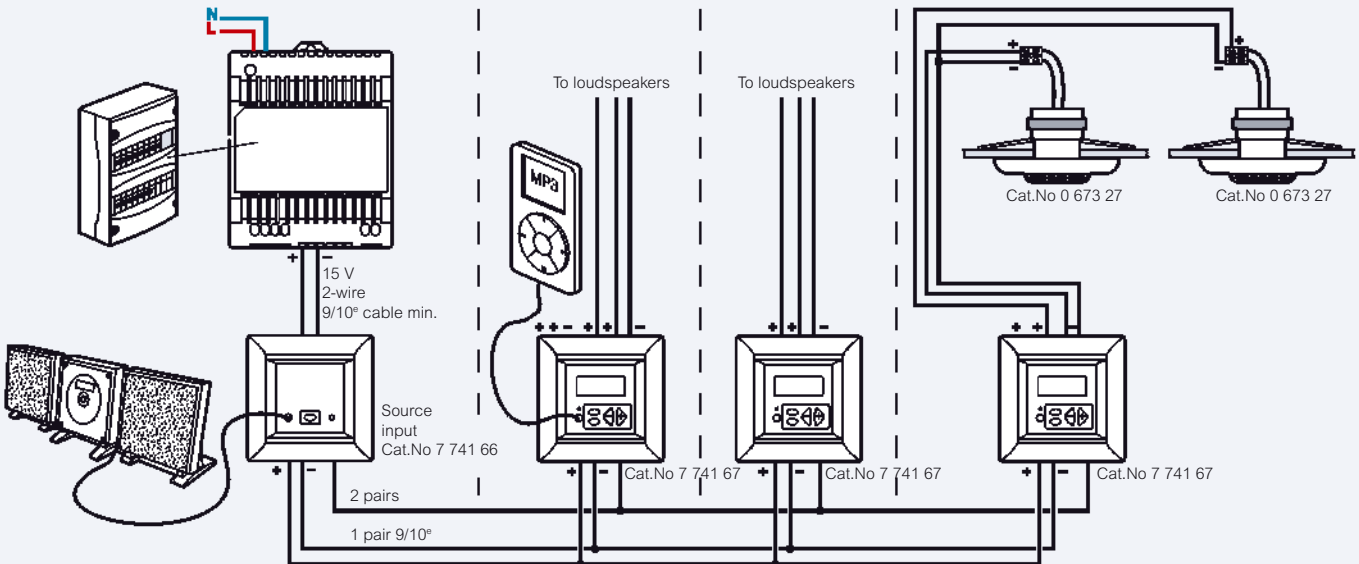

Diffusion of the main source, the auxiliary (MP3 player) or independent FM radio, via local control Cat.Nos 7 741 67/7 700 67/7 702 67 and tuner extension Cat.Nos 7 741 68/7 700 68/7 702 68

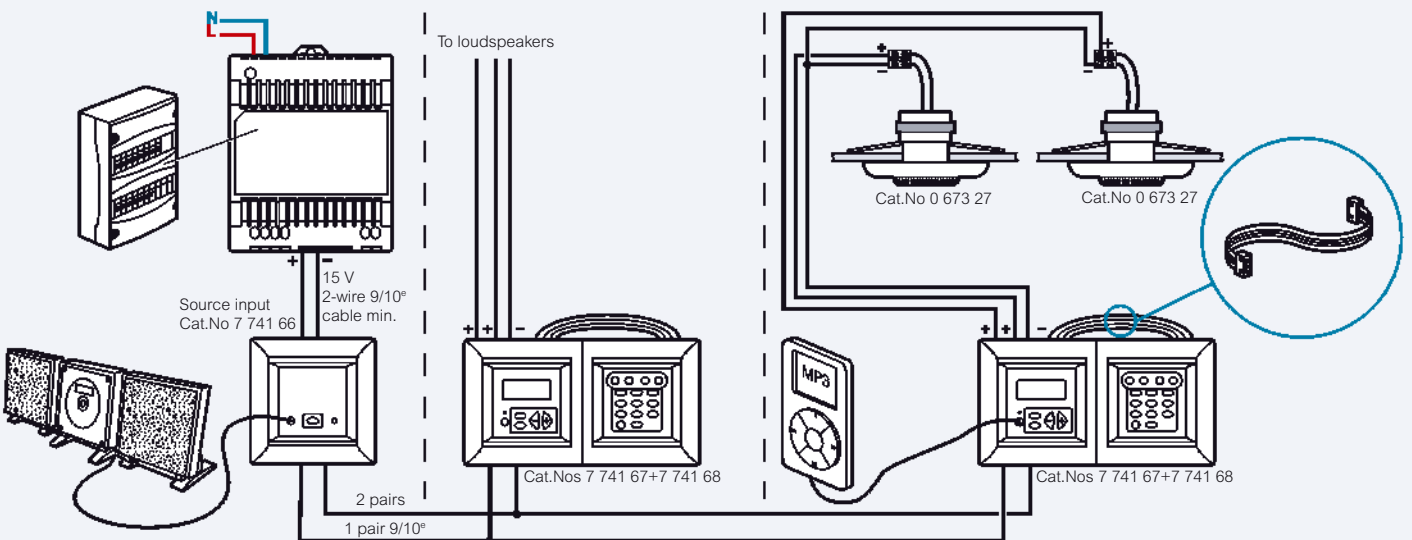

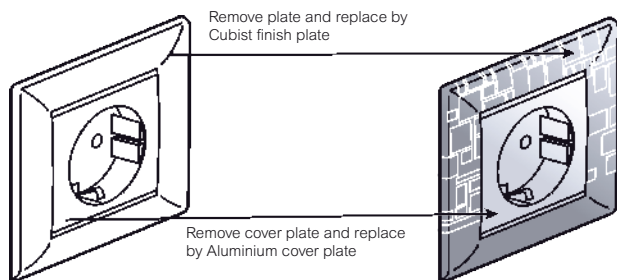

**UPGRADE YOUR CURRENT INSTALLATION**

FUNCTIONS			ALUMINIUM COVER PLATES						
			For single control	For double control	For 2P+E German standard socket	For 2P+E German standard shuttered	For 2P+E French standard socket	For single R45 socket	For single TV socket
One-way switch 10 AX		7 744 01 7 743 01	7 702 51	-	-	-	-	-	-
Two-way switch 10 AX		7 744 06 7 743 06	7 702 51	-	-	-	-	-	-
Intermediate switch 10 AX		7 744 07 7 743 07	7 702 51	-	-	-	-	-	-
Push-button 10 A		7 744 11 7 743 11	7 702 51	-	-	-	-	-	-
Two-way switch 16 AX		7 742 05 7 741 05	7 702 51	-	-	-	-	-	-
2-gang one-way switch 10 AX		7 744 05 7 743 05	-	7 702 52	-	-	-	-	-
2-gang two-way switch 10 AX		7 744 08 7 743 08	-	7 702 52	-	-	-	-	-
Double changeover push-button 10 A		7 742 18 7 741 18	-	7 702 52	-	-	-	-	-
2P+E 16 A German standard Screw terminals		7 744 20 7 743 20	-	-	7 702 53	7 702 57	-	-	-
2P+E 16 A German standard Screw terminals with shutters		7 744 21 7 743 21	-	-	-	7 702 57	-	-	-
2P+E 16 A French standard Screw terminals		7 743 96 7 743 98	-	-	-	-	7 702 54	-	-
RJ 45 UTP Cat. 5e		7 742 30 7 741 30 7 742 38 7 741 38	-	-	-	-	-	7 702 55	-
RJ 45 UTP Cat. 6		7 742 46 7 741 46 7 742 42 7 741 42	-	-	-	-	-	7 702 55	-
TV star socket - Att ≤ 1,5 dB		7 744 29 7 743 29	-	-	-	-	-	-	7 702 56
TV terminal socket - Att ≤ 10 dB		7 744 30 7 743 30	-	-	-	-	-	-	7 702 56
TV throughwiring - Att ≤ 14 dB		7 744 31 7 743 31	-	-	-	-	-	-	7 702 56



# VALENA™

## the plugged into real life

MADE IN CREATIVITY, **DESIGN AND FREEDOM**

**NEW TRENDY ENVIRONMENTS**

- WHITE
- IVORY
- ALUMINIUM

### White



Pied de Poule



Light Pearl



White



White / Silver



White / Crystal

### Ivory



Baroque Matt Gold



Matt Gold



Tanned Wood



Ivory



Ivory/Gold

### Aluminium



Cubist Alu



Brushed Alu/Silver



Alu



Alu/Silver



Black/Silver



Dark Wood / Silver

**Necessary to reposition the trims in 4 and 5 gang installations**

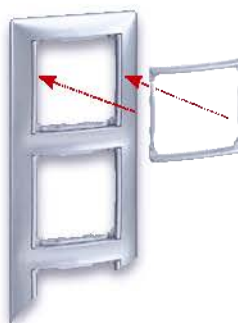

If you need to install the plates horizontally it's necessary to remove the trims and reposition them



# Valena™

## plate selection charts

PLATES	Horizontal			Vertical		Horizontal and vertical <sup>1</sup>	
	1 gang 	2 gang 	3 gang 	2 gang 	3 gang 	4 gang 	5 gang 
Ivory 	7 743 51	7 743 52	7 743 53	7 743 56	7 743 57	7 743 54	7 743 55
Ivory Gold 	7 741 51	7 741 52	7 741 53	7 741 56	7 741 57	7 741 54	7 741 55
Matt Gold <b>N</b> 	7 703 01	7 703 02	7 703 03	7 703 06	7 703 07	7 703 04	7 703 05
Tanned Wood <b>N</b> 	7 703 11	7 703 12	7 703 13	7 703 16	7 703 17	7 703 14	7 703 15
Baroque Matt Gold <b>N</b> 	7 700 20	-	-	-	-	-	-
White 	7 744 51	7 744 52	7 744 53	7 744 56	7 744 57	7 744 54	7 744 55
White / Crystal 	7 744 61	7 744 62	7 744 63	7 744 66	7 744 67	7 744 64	7 744 65
White / Silver 	7 704 91	7 704 92	7 704 93	7 704 96	7 704 97	7 704 94	7 704 95
Light Pearl <b>N</b> 	7 704 71	7 704 72	7 704 73	7 704 76	7 704 77	7 704 74	7 704 75
"Pied de Poule" <b>N</b> 	7 704 20	-	-	-	-	-	-
Aluminium 	7 701 51	7 701 52	7 701 53	7 701 56	7 701 57	7 701 54	7 701 55
Aluminium Silver 	7 703 51	7 703 52	7 703 53	7 703 56	7 703 57	7 703 54	7 703 55
Dark Wood Silver 	7 703 71	7 703 72	7 703 73	7 703 76	7 703 77	7 703 74	7 703 75
Black Silver 	7 703 91	7 703 92	7 703 93	7 703 96	7 703 97	7 703 94	7 703 95
Brushed Alu <b>N</b> 	7 703 31	7 703 32	7 703 33	7 703 36	7 703 37	7 703 34	7 703 35
Cubist Alu <b>N</b> 	7 703 41	7 703 42	7 703 43	7 703 46	7 703 47	7 703 44	7 703 45

1: Can be transformed in vertical or horizontal plate by rotation of internal trim (see opposite)



7 758 06 Aluminium finish

7 758 20 Aluminium finish

7 758 05 Aluminium finish

7 756 55 Pearl finish

7 756 57 Aluminium finish

Cover plate selection charts **p. 475-481**  
Plate selection charts **p. 482-483**

Mechanisms with metal support, claw or screw mounting  
To be equipped with cover plates (p. 475 to 481) and plates (p. 482)

Pack	Cat.Nos	Switches 10 AX - 250 V~	Pack	Cat.Nos	Switches 16 A - 250 V~
		<b>1 gang - standard switches</b>			<b>1 gang - standard switches</b>
10	7 758 01	One-way switch	10	7 756 04	One-way switch
10	7 758 06	Two-way switch	10	7 756 06	Two-way switch
10	7 758 07	Intermediate switch			<b>1 gang - illuminated switch</b>
		<b>1 gang - illuminated switches</b>			Equipped with a 0.5 mA green lamp Cat.No 7 758 97
10	7 756 00	Illuminated one-way switch	10	7 756 09	Illuminated two-way switch
10	7 756 02	Illuminated two-way switch			<b>1 gang - 2-pole switches</b>
1	7 758 27	Illuminated intermediate switch			2-pole switch
		<b>1 gang - indicator switches</b>	10	7 756 05	2-pole indicator switch
10	7 756 01	One-way indicator switch with neutral	10	7 756 81	2-pole indicator switch
10	7 758 20	Two-way indicator switch with neutral			Equipped with a 1.0 mA orange lamp Cat.No 7 758 98
		<b>1 gang - 2-pole switches</b>			<b>Automatic switches - 230 V~</b>
10	7 758 02	2-pole switch			<b>Without neutral - 300 W</b>
		<b>1 gang - 2-pole switches</b>			For installation in place of a 1-gang switch without additional wiring
10	7 758 22	2-pole indicator switch with neutral	1	7 756 55	40 to 300 W incandescent and 230 V~ halogen lamps
		Equipped with a 1.0 mA orange lamp Cat.No 7 758 98			Luminosity threshold: 3 to 1000 lux
		<b>1 gang - 3-pole switch</b>			Temporization: 1 s to 6 min.
10	7 758 03	3-pole switch 400 V			Horizontal detection angle: 130°
		<b>2 gang - standard switches</b>			<b>Without neutral - 400 W</b>
10	7 758 05	2 gang one-way switch	1	7 756 56	With override
10	7 758 08	2 gang two-way switch			40 to 400 W incandescent and 230 V~ halogen lamps
		<b>2 gang - illuminated switches</b>			40 to 400 VA ELV halogen lamps via ferromagnetic or electronic transformer
1	7 758 25	Illuminated 2-gang one-way switch in both circuits			Detection range between 3 and 10 m
10	7 756 08	Illuminated 2-gang two-way switch			Luminosity threshold: 3 to 1000 lux
		<b>2 gang - indicator switches</b>			Temporization: 1 s to 16 min
10	7 758 45	Equipped with a 1.0 mA orange lamp Cat.No 7 758 98			Horizontal detection angle: 180°
10	7 758 69	2 gang one-way indicator switch with neutral - 1 indicator lamp	1	7 756 57	<b>With neutral - 1000 W</b>
		2 gang one-way indicator switch			With override
		2 indicator lamps			1000 W incandescent and 230 V~ halogen lamps
					500 VA halogen lamps with electronic or ferromagnetic transformer
					500 VA fluorescent tubes and compact lamps
					100 VA fans
					Detection range: max. 10 m
					Adjustable detection sensitivity
					Luminosity threshold: 3 to 1000 lux
					Temporization: 1 s to 16 min.
					Horizontal detection angle: 180°
					Manual remote control possible with normally closed push-button

## Galea™ Life

### other lighting control units



7 758 19 Pearl finish

7 759 62 White finish

7 813 50 Aluminium finish

Cover plate selection charts p. 475-481  
Plate selection charts p. 481-483

Mechanisms with metal support, screw mounting  
To be equipped with cover plates (p. 475 to 481) and plates (p. 482)

Pack	Cat.Nos	<b>Pull-cord mechanisms - 250 V~</b>
1	7 758 09	Claw or screw mounting Switch 6 AX
1	7 758 19	Changeover push-button 10 A

Pack	Cat.Nos	<b>Accessory for pull-cord mechanisms</b>
10	0 898 05	Pull-cord accessory 1.5 m length

Pack	Cat.Nos	<b>Time switches</b>
<b>With mechanical adjustment</b>		
Screw mounting only		
1	7 759 62	Time switch with mechanical adjustment from 0 to 15 minutes 10 A - 250 V~ For lighting, ventilation or heating
1	7 759 64	Time switch with mechanical adjustment from 0 to 120 minutes 10 A 250 V~ For heating and ventilation
<b>Programmable time switches</b>		
Screw and claw mounting 3-wire - 1000 W Supplied with cover plate		
1	7 810 50	White cover
1	7 812 50	Dark bronze cover
1	7 813 50	Aluminium cover
1	7 814 50	Titanium cover
1	7 815 50	Pearl cover

Pack	Cat.Nos	<b>Time delay switch</b>
1	7 756 62	Screw and claw mounting 2-wire

Pack	Cat.Nos	<b>Latching relay</b>
1	7 756 61	Screw and claw mounting 3-wire - 1000 W

Pack	Cat.Nos	<b>Lighting ventilation switch</b>
10	7 757 50	Screw and claw mounting 3-wire - 2 x 400 W

## Galea™ Life

### roller blind controls



7 756 83 Aluminium finish

7 756 97 Aluminium finish

Cover plate selection charts p. 475-481  
Plate selection charts p. 481-483

Mechanisms with metal support, screw mounting  
To be equipped with cover plates (p. 475 to 481) and plates (p. 482)

Pack	Cat.Nos	<b>Roller blind control for somfy motors</b>
1	7 756 83	Individual radio roller blinds control Enables remote control of roller blinds compatible with somfy RTS Radio transmission of up, down and stop orders to the RTS motor Range: 50 m in open field Operates with 1 lithium battery 3 V, CR 2032 type supplied For direct fixing on wall, without flush-mounting box

Pack	Cat.Nos	<b>Roller blind controls 230 V - 3 A - 50/60 Hz</b>
<b>Control units</b>		
Screw mounting For controlling electric roller blind (daily programme) by setting "up" and "down" switch handles with 15 min. intervals In "Off" position the programme is stopped		
1	7 757 46	White cover
1	7 756 96	Dark Bronze cover
1	7 756 97	Aluminium cover
1	7 756 98	Titanium cover
1	7 756 99	Pearl cover
<b>Relay for roller blinds</b>		
1	7 757 49	Awning control in parallel with a control unit and/or an additional local control Permissible load: 2 x 750 VA Consumption: 1 W Max. pilot wire length: 50 metres Terminal capacity: 2.5 mm Dimensions: 49 x 46.4 x 25.8 mm Can be mounted in a Ø60 mm flush-mounting box

## Galea™ Life

### dimmers



7 756 54 Titanium finish



7 756 52 Dark Bronze finish

Cover plate selection charts **p. 475-481**  
 Plate selection charts **p. 482-483**

Mechanisms with metal support, claw or screw mounting  
 To be equipped with cover plates (p. 475 to 481) and plates (p. 482)

Pack	Cat.Nos	Rotary control dimmers 230 V~ 50 Hz
1	7 756 54	<b>400 W dimmer</b> 40 to 400 W For incandescent and halogen lamps 230 V~ and ELV with ferromagnetic transformer
1	7 759 03	<b>420 W dimmer</b> 420 W for incandescent lamps and halogen lamps 230 V~ and ELV with electronic transformer
1	7 759 01	<b>1-10 V electronic potentiometer</b> For fluorescent lights with 1-10 V dimmable ballast
		<b>Push-button dimmers</b> With an on/off button and a separate +/- button for dimming
1	7 756 52	<b>400 W dimmer for all types of loads</b> 40 to 400 W incandescent and 230 V~ halogen lamps 40 to 400 VA ELV halogen lamps with ferromagnetic or electronic transformer Can be remotely controlled via non-illuminated push-button or two-way switch
1	7 756 53	<b>600 W dimmer</b> 40 to 600 W incandescent and 230 V~ halogen lamps 40 to 600 VA ELV halogen lamps with ferromagnetic transformer

## Galea™ Life

### push-buttons



7 758 11 Aluminium finish



7 758 13 Aluminium finish

Cover plate selection charts **p. 475-481**  
 Plate selection charts **p. 482-483**

Mechanisms with metal support, claw or screw mounting  
 To be equipped with cover plates (p. 475 to 481) and plates (p. 482)

Pack	Cat.Nos	Push-buttons 10 A - 250 V~
10	7 758 11	<b>1 gang - standard push-buttons</b> Push-button Changeover push-button
10	7 758 16	
10	7 758 13	<b>1 gang - illuminated push-buttons</b> Illuminated push-button Equipped with a 1.0 mA green lamp Cat.No 7 758 90
10	7 758 46	
10	7 758 17	Illuminated changeover push-button with neutral Equipped with a 1.0 mA green lamp Cat.No 7 758 90 Illuminated changeover push-button with potential free contact Equipped with a 1.0 mA orange lamp Cat.No 7 758 98 For use with buzzer Cat.Nos 7 757 09/10 Illuminated push-button round shape
10	7 758 44	
1	7 758 18	<b>2 gang - standard push-buttons</b> 2 gang changeover push-button Changeover push-button + two-way switch
1	7 758 10	

# Galea™ Life

thermostats



# Galea™ Life

access control, buzzers and chimes



7 756 86 Titanium finish



7 756 87 Pearl finish



7 759 54 Aluminium finish



7 757 10 Titanium finish

Cover plate selection charts p. 475-481  
Plate selection charts p. 482-483

Mechanisms with metal support, claw or screw mounting  
To be equipped with cover plates (p. 475 to 481) and plates (p. 482)

Pack	Cat.Nos	Thermostats 230 V~ - 50/60 Hz
		<b>Thermostat with one potential free NC/NO contact</b> 8 A cos $\varphi$ = 1 resistive circuits 4 A cos $\varphi$ = 0.6 inductive circuits Adjustment: 5 °C to 30 °C
1	7 758 15	White central cover
1	7 756 84	Dark Bronze central cover
1	7 756 85	Aluminium central cover
1	7 756 86	Titanium central cover
1	7 756 87	Pearl central cover
		<b>Comfort thermostat with one NO/NC contact and LED</b> 8 A cos $\varphi$ = 1 resistive circuits 4 A cos $\varphi$ = 0.6 inductive circuits Adjustment: 5 °C to 30 °C
1	7 758 67	White central cover
1	7 756 92	Dark Bronze central cover
1	7 756 93	Aluminium central cover
1	7 756 94	Titanium central cover
1	7 756 95	Pearl central cover
		<b>Thermostat for electric floor heating</b> With one potential free N/O contact and LED, 16 A - 230 V~ Adjustment: 10 °C to 60 °C
1	7 758 58	White central cover
1	7 756 88	Dark Bronze central cover
1	7 756 89	Aluminium central cover
1	7 756 90	Titanium central cover
1	7 756 91	Pearl central cover
		<b>Electronic room thermostat</b>
1	7 758 68	230 V~ 50/60 Hz Adjustment 5 °C to 30 °C Adjustment accuracy +/- 0.5 °C With one potential free C/O contact LV breaking capacity: 8 A - 250 V resistive circuit 2 A - 250 V inductive circuit ELV breaking capacity From 1 mA min. to 500 VA max. 12 to 48 V/12 to 24 V

Cover plate selection charts p. 475-481  
Plate selection charts p. 482-483

Mechanisms with metal support, claw or screw mounting  
To be equipped with cover plates (p. 475 to 481) and plates (p. 482)

Pack	Cat.Nos	Keycard switches
		Claw or screw mounting Used to switch off all power in hotel rooms Switch on or off by inserting a card key fob or debit card, max. width 54 mm Card not supplied
		<b>Mechanical keycard switch</b>
10	7 759 54	Mechanism equipped with an illuminated two-way push-button with 1 x 10 A NC/NO contact Power supply 230 V Equipped with a 0.5 mA green lamp Cat.No 7 758 90
		<b>Electronic keycard switch</b>
1	7 759 55	Mechanism with 30 s time relay after key fob removal Power supply 230 V - 50/60 Hz
		<b>Keycard</b>
10	0 898 06	Keycard For use of keycard switch in hotels Supplied complete with a label holder for individual hotel identification
		<b>Buzzers</b>
		Screw mounting
		<b>230 V - 50 Hz</b>
1	7 757 11	Anthracite central cover plate
1	7 757 12	White central cover plate
		<b>Electronic chimes</b>
		Screw mounting
		<b>8/12 V - 50/60 Hz</b>
		For use with push-button Cat.No 7 758 17
1	7 757 10	Anthracite central cover plate
1	7 757 09	White central cover plate
		<b>230 V~ - 50/60 Hz</b>
		With 10 melodies (85 dB)
1	7 757 17	Anthracite central cover plate
1	7 757 18	White central cover plate

## Galea™ Life

### telephone sockets



7 759 38 Aluminium finish



7 759 39 Titanium finish

Cover plate selection charts **p. 475-481**  
 Plate selection charts **p. 482-483**

Mechanisms with metal support, claw or screw mounting  
 To be equipped with cover plates (p. 475 to 481) and plates (p. 482)

Pack	Cat.Nos	Telephone sockets
10	7 759 38	<b>RJ 11 socket</b> 4 contacts with 1 connector Mechanism equipped with a 1/4 turn self-stripping connector
10	7 759 39	<b>Double RJ 11 socket</b> 4 contacts with 2 connectors Mechanism equipped with a 1/4 turn self-stripping connectors
10	7 759 37	<b>Special ISDN RJ 45 socket</b> 4 contacts with 2 connectors Mechanism equipped with a 1/4 turn self-stripping connectors
10	7 757 81	<b>Double RJ 45/RJ 11 VDI socket</b> Socket with 1 RJ 11 connector and 1 RJ 45 Cat. 6 UTP connector

## Galea™ Life

### data sockets



7 758 28 Pearl finish



7 757 68 Dark Bronze finish

Cover plate selection charts **p. 475-481**  
 Plate selection charts **p. 482-483**

Mechanisms with metal support  
 To be equipped with cover plates (p.475 to 481) and plates (p. 482)  
 VDI (voice, data, image) sockets  
 Fast connection sockets, no tool required  
 Contacts marked with 568 A and B dual colour code and numbered  
 Self-stripping terminals

Pack	Cat.Nos	Data sockets for UTP cables
10	Category 5e 7 757 61	Category 6 7 758 28 RJ 45 socket with 1 connector Screw mounting
10	7 757 62	7 758 30 RJ 45 socket with 2 connectors Screw mounting
10	7 757 65	7 758 47 RJ 45 socket with 1 connector Claw mounting
10	7 757 66	7 758 23 RJ 45 socket with 2 connectors Claw mounting
10	Category 6 7 757 67	<b>Data sockets for STP cables</b> Screw mounting in flush-mounting box RJ 45 socket with 1 connector
10	7 757 68	RJ 45 socket with 2 connectors
10	Category 6 7 757 98	<b>Data sockets for FTP cables</b> Screw mounting in flush-mounting box RJ 45 socket with 1 connector
10	7 757 99	RJ 45 socket with 2 connectors
10	7 758 85	<b>Data accessories</b> Adaptor for AMP data socket



## Galea™ Life

### television sockets



7 759 65 Pearl finish



7 757 89 Aluminium finish

Cover plate selection charts **p. 475-481**  
 Plate selection charts **p. 482-483**

Mechanisms with metal support, claw or screw mounting  
 To be equipped with cover plates (p. 475 to 481) and plates (p. 482)  
 For Hertzian and satellite installation (with individual demodulator)  
 DTT and HDTV compatible-shielded sockets  
 TV: male connector (Ø9.5 mm)  
 R: female connector (Ø9.5 mm)  
 SAT: "F" type connector  
 Recommended coaxial cable: 17/19 VATC

Pack	Cat.Nos	TV-R-SAT sockets
10	7 757 89	TV: 5-68/120 - 862 MHz R: 87-5-108 MHz SAT: 550-2400 MHz Star - 1.5 dB
10	7 757 90	Terminal - 10 dB
10	7 757 91	Passthrough - 14 dB
<b>TV-R sockets</b>		
10	7 757 86	TV: 5-68/120-862 MHz R: 87-5-108 MHz Star - 1.5 dB
10	7 757 87	Terminal - 10 dB
10	7 757 88	Passthrough - 14 dB
<b>TV sockets</b>		
10	7 759 65	TV: 0-2400 MHz Star - 1.5 dB
10	7 759 66	Terminal - 10 dB
10	7 759 67	Passthrough - 14 dB
<b>TV sockets "F" type with screws</b>		
10	7 756 80	SAT: 0-2400 MHz Star - 1.5 dB

## Galea™ Life

### socket outlets



7 759 21 Pearl finish



7 759 30 White finish



7 758 48 White finish

Cover plate selection charts **p. 475-481**  
 Plate selection charts **p. 482-483**

Mechanisms with metal support, claw or screw mounting  
 To be equipped with cover plates (p. 475 to 481) and plates (p. 482)

Pack	Cat.Nos	Socket outlets
10	7 759 16	IP 2X protection <b>2P socket</b> 2P
10	7 759 21	<b>German standard - screw terminals</b> 2P+E
10	7 759 30	2P+E tamperproof
10	7 759 20	<b>German standard - automatic terminals</b> 2P+E
10	7 758 48	<b>British standard - screw terminals 13 A / 250 V</b> Switched with safety shutters
10	7 758 49	Unswitched
10	7 758 36	<b>Euro-US and US standards - screw terminals</b> 2P - Euro/US 15 A / 127 V - 16 A / 250 V
10	7 758 37	2P+E - Euro/US 15 A / 127 V - 16 A / 250 V
10	7 758 38	2P+E - US 15 A / 127 V



7 713 24 Aluminium finish



7 710 44 White finish



7 710 45 White finish



7 715 39 Pearl finish



7 712 31 Dark Bronze finish



Plate selection charts p. 482-483

Mechanisms with metal support, claw or screw mounting

Pack	Cat.Nos	Socket outlets with cover plate with mechanical plug ejection
		To be equipped with plates (p. 482)
		<b>German standard screw terminals</b>
10	7 770 24	2P+E White cover plate
5	7 712 24	2P+E Dark Bronze cover plate
5	7 713 24	2P+E Aluminium cover plate
5	7 714 24	2P+E Titanium cover plate
5	7 715 24	2P+E Pearl cover plate
		<b>Socket outlets with cover plate</b>
		IP 2X protection, automatic terminals (except Cat.No 7 759 25)
		To be equipped with plates (p. 482)
		<b>German standard</b>
10	7 710 62	2P+E White cover plate
10	7 712 62	2P+E Dark Bronze cover plate
10	7 713 62	2P+E Aluminium cover plate
10	7 714 62	2P+E Titanium cover plate
10	7 715 62	2P+E Pearl cover plate
1	7 759 25	2P+E White cover plate - screw terminals
		<b>German standard with safety shutters</b>
10	7 710 63	2P+E White cover plate
10	7 712 63	2P+E Dark Bronze cover plate
10	7 713 63	2P+E Aluminium cover plate
10	7 714 63	2P+E Titanium cover plate
10	7 715 63	2P+E Pearl cover plate
		<b>German standard with safety shutters and cover</b>
10	7 710 64	2P+E White cover plate
10	7 712 64	2P+E Dark Bronze cover plate
10	7 713 64	2P+E Aluminium cover plate
10	7 714 64	2P+E Titanium cover plate
10	7 715 64	2P+E Pearl cover plate
		<b>German standard - tamperproof</b>
10	7 710 29	2P+E red cover plate
		<b>Socket outlets with cover plate and lamp indicator</b>
		IP 2X protection, screw terminals
		To be equipped with plates (p. 482)
		<b>German standard with safety shutters</b>
10	7 710 48	2P+E White cover plate
10	7 710 44	2P+E Green cover plate
10	7 710 45	2P+E Orange cover plate
10	7 710 46	2P+E Red cover plate

Pack	Cat.Nos	Socket outlets with cover plate and plate
		IP 2X protection
		<b>German standard - screw terminals</b>
10	7 710 39	2P+E White cover plate and plate
10	7 712 39	2P+E Dark Bronze cover plate and plate
10	7 713 39	2P+E Aluminium cover plate and plate
10	7 714 39	2P+E Titanium cover plate and plate
10	7 715 39	2P+E Pearl cover plate and plate
		<b>German standard - automatic terminals</b>
10	7 710 40	2P+E White cover plate and frame
10	7 712 40	2P+E Dark Bronze cover plate and frame
10	7 713 40	2P+E Aluminium cover plate and frame
10	7 714 40	2P+E Titanium cover plate and frame
10	7 715 40	2P+E Pearl cover plate and frame
		<b>Twin socket outlets with cover plate and plate</b>
		IP 2X protection
		<b>German standard - screw terminals</b>
5	7 710 30	2 x 2P+E White cover plate and plate
5	7 712 30	2 x 2P+E Dark Bronze cover plate and plate
5	7 713 30	2 x 2P+E Aluminium cover plate and plate
5	7 714 30	2 x 2P+E Titanium cover plate and plate
5	7 715 30	2 x 2P+E Pearl cover plate and plate
		<b>German standard - screw terminals with safety shutters</b>
5	7 710 31	2 x 2P+E White cover plate and plate
5	7 712 31	2 x 2P+E Dark Bronze cover plate and plate
5	7 713 31	2 x 2P+E Aluminium cover plate and plate
5	7 714 31	2 x 2P+E Titanium cover plate and plate
5	7 715 31	2 x 2P+E Pearl cover plate and plate
		<b>German standard - automatic terminals with safety shutters</b>
5	7 710 33	2 x 2P+E White cover plate and plate
5	7 712 33	2 x 2P+E Dark Bronze cover plate and plate
5	7 713 33	2 x 2P+E Aluminium cover plate and plate
5	7 714 33	2 x 2P+E Titanium cover plate and plate
5	7 715 33	2 x 2P+E Pearl cover plate and plate

# Galea™ Life

## cable outlets, blanking plates and pilot lights



7 759 85 Titanium finish



7 759 78 Dark Bronze finish



7 759 40 Aluminium finish



7 759 41 Titanium finish

Cover plate selection charts p. 475-481  
Plate selection charts p. 482-483

Mechanisms with metal support, claw or screw mounting

Pack	Cat.Nos	Miscellaneous functions
10	7 759 85	<b>Cable outlet</b> With 5 terminals to take 5 x 2.5 mm <sup>2</sup> cables With cable grip
10	7 759 86	Without terminals
10	7 759 78	<b>Fuse carrier</b> With Anthracite Grey cap
10	7 770 78	<b>Blanking plates</b> Without cable grip Supplied with cover plate White cover plate
1	7 712 78	Dark Bronze cover plate
1	7 713 78	Aluminium cover plate
1	7 714 78	Titanium cover plate
1	7 715 78	Pearl cover plate
10	7 759 40	<b>Pilot lights</b> <b>E 10 - 3 W lamp</b> Red diffuser
1	7 759 43	<b>E 10 - 5 W lamp</b> Transparent diffuser
1	7 759 44	<b>Information light</b> E 10 - 3 W lamp with transparent diffuser
1	7 759 41	<b>Self-contained pilot light unit 230 V~ - 50 Hz</b> Plug-in self-contained unit Working reserve 1 h With a 2.2 V E 10 - 0.25 A lamp Lights automatically in the event of a power cut With status indicator With two KR 18/29 1.2 V - 0.5 A Ni-Cd batteries

Pack	Cat.Nos	Accessories for pilot lights																				
10	7 759 45	<b>Covers</b> Transparent cover																				
10	7 759 46	Green cover																				
10	7 759 47	Orange cover																				
10	7 759 48	Red cover																				
1	7 759 42	<b>Replacement lamp</b> Replacement lamp for Cat.No 7 759 41																				
10	7 758 00	<b>Information accessories</b> <b>Set of replacement labels with symbols</b> For fitting in rocker plate with indicators Cat.Nos 7 770 11, 7 712 11, 7 713 11, 7 714 11, 7 715 11 Comprises 4 discs: <table border="1"> <tr> <td></td> <td></td> <td rowspan="2">Disk 1 - audible signal, lamp, red symbol and transparent symbol</td> </tr> <tr> <td></td> <td></td> </tr> <tr> <td></td> <td></td> <td rowspan="2">Disk 2 - key, fan, socket and cellar</td> </tr> <tr> <td></td> <td></td> </tr> <tr> <td></td> <td></td> <td rowspan="2">Disk 3 - up staircase and down staircase, entrance/garden</td> </tr> <tr> <td></td> <td></td> </tr> <tr> <td></td> <td></td> <td rowspan="2">Disk 4 - TV, computer, Hi-fi and heating</td> </tr> <tr> <td></td> <td></td> </tr> </table>			Disk 1 - audible signal, lamp, red symbol and transparent symbol					Disk 2 - key, fan, socket and cellar					Disk 3 - up staircase and down staircase, entrance/garden					Disk 4 - TV, computer, Hi-fi and heating		
		Disk 1 - audible signal, lamp, red symbol and transparent symbol																				
		Disk 2 - key, fan, socket and cellar																				
		Disk 3 - up staircase and down staircase, entrance/garden																				
		Disk 4 - TV, computer, Hi-fi and heating																				

## Galea™ Life

### IP 44 functions



7 758 52 White finish



7 759 24 White finish

Plate selection charts p. 482-483

Mechanisms with metal support, claw or screw mounting and supplied with white cover plate  
For installation in Ø60 mm boxes flush-mounting boxes with IP 44 protection

Pack	Cat.Nos	Switches
10	7 758 52	One-way switch
10	7 710 20	Two-way switch
10	7 710 24	Intermediate switch
10	7 710 21	2-gang one-way switch
10	7 710 22	2-gang two-way switch
<b>Push-button</b>		
10	7 710 23	Latching push-button
<b>Socket outlets</b>		
<b>German standard</b>		
10	7 759 24	2P+E - screw terminals
10	7 710 27	2P+E - automatic terminals
1	7 710 28	2P+E - key protected socket outlet with flap
<b>French standard</b>		
10	7 759 29	2P+E - screw terminals
<b>Accessories</b>		
<b>Key protection for German standard socket outlet</b>		
1	7 759 99	Accessory for key protection
<b>Kit for IP 44 protection</b>		
Composition		
- protection seal		
- white cover plate		
10	7 711 50	For illuminated functions
10	7 711 51	For pictogram use
10	7 711 52	For double functions
10	7 711 53	For roller blinds double functions
10	7 711 54	For label holder use
1	7 710 26	For movement detector

## Galea™ Life

### accessories



7 710 96



7 710 97

Pack	Cat.Nos	Miscellaneous accessories
<b>Lamps</b>		
For illuminating standard mechanisms		
10	7 758 93	230 V - 1 mA lamp + cassette - neon
10	7 758 94	230 V - 0.5 mA lamp + cassette - green
10	7 758 95	230 V - 1.0 mA lamp + cassette - orange
10	7 758 96	8-12 V - 15 mA lamp + cassette - green
<b>Replacement lamps</b>		
10	7 758 90	230 V - 1 mA - green
10	7 758 97	230 V - 0.5 mA - green
10	7 758 98	230 V - 1 mA - orange
10	7 758 99	8-12 V - 15 mA - green
10	7 758 92	E10 - 230 V - 3 W lamp
10	0 898 40	E10 - 230 V - 5 W lamp
10	7 758 91	Replacement lamp for making illuminated functions Cat.Nos 7 759 03 and 7 759 01
<b>Other accessories</b>		
10	7 759 49	Long claws
20	7 759 00	Site protective cover (painting protection)
50	7 759 92	VDI claws - for claw mounting RJ 45 STP mechanisms
<b>Surface-mounting boxes</b>		
<b>Horizontal mounting</b>		
10	7 710 96	1 gang
5	7 710 97	2 gang
1	7 710 98	3 gang
<b>Accessory for adapting cables and tubes</b>		
10	7 761 84	White
<b>Combination accessory</b>		
For multiple vertical assemblies of surface boxes		
10	7 761 85	White

# Galea™ Life



















## rocker or cover plate selection charts



Mechanisms			Rocker or cover plates				
			White 	Dark Bronze 	Soft Aluminium 	Titanium 	Pearl 
<b>LIGHTING CONTROL MECHANISMS</b>							
One-way switch 10 A	7 758 01						
Two-way switch 10 A	7 758 06						
Intermediate switch 10 A	7 758 07						
One-way switch 16 A	7 756 04						
Two-way switch 16 A	7 756 06						
Push-button 10 A	7 758 11						
Changeover push-button	7 758 16						
One-way switch 10 A	7 758 01	Single rocker lamp symbol 	7 770 44	7 712 44	7 713 44	7 714 44	7 715 44
Two-way switch 10 A	7 758 06						
Intermediate switch 10 A	7 758 07						
One-way switch 16 A	7 756 04	Bell symbol 	7 770 46	7 712 46	7 713 46	7 714 46	7 715 46
Two-way switch 16 A	7 756 06						
Push-button 10 A	7 758 11	Stair symbol 	7 770 48	7 712 48	7 713 48	7 714 48	7 715 48
Changeover push-button	7 758 16						
Pull cord switch 6 AX	7 758 09						
Pull cord changeover push-button 10 A	7 758 19						
Illuminated push-button round shape	7 758 44						
Illuminated one-way switch 10 A	7 756 00						
One-way indicator switch with neutral 10 A	7 756 01						
Illuminated two-way switch 10 A	7 756 02						
Two-way indicator switch with neutral 10 A	7 758 20						
Illuminated intermediate switch 10 A	7 758 27						
Illuminated two-way switch 16 A	7 756 09						
Illuminated push-button 10 A	7 758 13						
Illuminated changeover push-button with neutral 10 A	7 758 46						
Illuminated changeover push-button with potential free contact (for use with buzzer Cat.Nos 7 759 09/10) 10 A	7 758 17						

Mechanisms			Rocker or cover plates					
			White 	Dark Bronze 	Soft Aluminium 	Titanium 	Pearl 	
<b>LIGHTING CONTROL MECHANISMS (continued)</b>								
Illuminated one-way switch 10 A	7 756 00	 Rocker for information symbol Cat.No 7 758 00						
One-way indicator switch with neutral 10 A	7 756 01							
Illuminated two-way switch 10 A	7 756 02							
Two-way indicator switch with neutral 10 A	7 758 20							
Illuminated intermediate switch 10 A	7 758 27							
Illuminated two-way switch 16 A	7 756 09							
Illuminated push-button 10 A	7 758 13							
Illuminated changeover push-button with neutral 10 A	7 758 46							
Illuminated changeover push-button with potential free contact (for use with buzzer Cat.Nos 7 759 09/10) 10 A	7 758 17							
Illuminated one-way switch 10 A	7 756 00	 Rocker plates for the partially sighted	Lamp symbol 7 710 10 (white)					
Indicator switch with neutral 10 A	7 756 01							
Illuminated two-way switch 10 A	7 756 02							
Two-way indicator switch with neutral 10 A	7 758 20			Key symbol 7 710 11 (white)				
Illuminated intermediate switch 10 A	7 758 27							
Illuminated two-way switch 16 A	7 756 09							
Illuminated push-button 10 A	7 758 13			Bell symbol 7 710 12 (white)				
Illuminated changeover push-button with neutral 10 A	7 758 46							
Illuminated changeover push-button with potential free contact (for use with buzzer Cat.Nos 7 759 09/10) 10 A	7 758 17							
Changeover push-button + two-way switch	7 758 10							
2-gang one-way switch 10 AX	7 758 05							
2-gang two-way switch 10 AX	7 758 08							
2-gang changeover push-button 10	7 758 18							
Illuminated 2-gang one-way switch 10 AX	7 758 25							
Illuminated 2-gang two-way switch 10 AX	7 756 08							
2-gang one-way indicator switch	7 758 69							
2-pole switch 10 AX	7 758 02							
3-pole switch 10 AX	7 758 03							
2-pole switch 16 A	7 756 05							

# Galea™ Life

## rocker or cover plate selection charts (continued)

Mechanisms			Rocker or cover plates				
			White 	Dark Bronze 	Soft Aluminium 	Titanium 	Pearl 
<b>LIGHTING CONTROL MECHANISMS (continued)</b>							
2-pole indicator switch with neutral 10 AX	7 758 22		7 770 18	7 712 18	7 713 18	7 714 18	7 715 18
2-pole indicator switch 16 A	7 756 81						
2-gang one-way indicator switch with neutral 10 A - 1 circuit	7 758 45		-	7 712 45	7 713 45	7 714 45	7 715 45
Illuminated push-button with label holder	7 758 13		7 770 17	7 712 17	7 713 17	7 714 17	7 715 17
3-wire latching relay 1000 W	7 756 61		7 810 59	7 812 59	7 813 59	7 814 59	7 815 59
2-wire time relay switch	7 756 62						
3-wire lighting ventilation switch 2 x 400 W	7 757 50						
<b>VENTILATION CONTROL AND TIME SWITCH DEVICES</b>							
Time switch with mechanical adjustment from 0 to 15 minutes 16 A 250 V~	7 759 62		7 770 57	7 712 57	7 713 57	7 714 57	7 715 57
Time switch with mechanical adjustment from 0 to 120 minutes 16 A 250 V~	7 759 64						
Time switch 1000 W with neutral	Mechanism supplied with cover plate		7 810 50	7 812 50	7 813 50	7 814 50	7 815 50
<b>DIMMERS AND AUTOMATIC SWITCHES</b>							
Dimmer 400 W	7 756 54		7 710 68	7 712 68	7 713 68	7 714 68	7 715 68
Dimmer 420 W	7 759 03		7 770 60	7 712 60	7 713 60	7 714 60	7 715 60
Electronic potentiometer 1-10 V	7 759 01						
Dimmer for all loads 400 W	7 756 52		7 710 86	7 712 86	7 713 86	7 714 86	7 715 86
Dimmer 600 W	7 756 53						
2-wire automatic switch 300 W	7 756 55		7 710 88	7 712 88	7 713 88	7 714 88	7 715 88
2-wire automatic switch 400 W with override	7 756 56		7 710 87	7 712 87	7 713 87	7 714 87	7 715 87
3-wire automatic switch 1000 W with override	7 756 57						

Mechanisms			Rocker or cover plates				
			White 	Dark Bronze 	Soft Aluminium 	Titanium 	Pearl 
<b>ACCESS CONTROL MECHANISMS</b>							
Mechanical key fob switch	7 759 54		7 770 54	7 712 54	7 713 54	7 714 54	7 715 54
Electronic card-operated switch	7 759 55		7 710 74	7 712 74	7 713 74	7 714 74	7 715 74
<b>CABLE OUTLET AND BLANKING PLATES, PILOT LIGHTS</b>							
Cable outlet with 5 terminals	7 759 85		7 770 85	7 712 85	7 713 85	7 714 85	7 715 85
Cable outlet without terminals	7 759 86						
Blanking plate	Mechanism supplied with cover plate		7 770 78	7 712 78	7 713 78	7 714 78	7 715 78
Self-contained pilot light unit 230 V - 50 Hz	7 759 41		7 770 41	7 712 41	7 713 41	7 714 41	7 715 41
Pilot light with E 10 - 3 W lamp with a red diffuser	7 759 40		7 770 19	7 712 19	7 713 19	7 714 19	7 715 19
Pilot light with E 10 - 5 W lamp with a transparent diffuser	7 759 43						
Information light with E 10 - 3 W lamp with a transparent diffuser	7 759 44						
Fuse carrier with Anthracite Grey cap	7 759 78		-	7 712 77	7 713 77	7 714 77	7 715 77
<b>ROLLER BLINDS CONTROLS</b>							
Roller blind control for <b>somfy</b> motors	7 756 83		7 770 61	7 712 61	7 713 61	7 714 61	7 715 61
Roller blind control white cover	7 757 46		7 770 19	7 712 19	7 713 19	7 714 19	7 715 19
Roller blind control Dark Bronze cover	7 756 96						
Roller blind control Aluminium cover	7 756 97						
Roller blind control Titanium cover	7 756 98						
Roller blind control Pearl cover	7 756 99						















# Galea™ Life

## rocker or cover plate selection charts (continued)

Mechanisms			Rocker or cover plates					
			White 	Dark Bronze 	Soft Aluminium 	Titanium 	Pearl 	
<b>THERMOSTATS</b>								
Electronic room thermostat	7 758 68		7 770 53	7 712 53	7 713 53	7 714 53	7 715 53	
Thermostat (supplied with central cover)	White	7 758 15						
	Dark Bronze	7 756 84						
	Aluminium	7 756 85						
	Titanium	7 756 86						
	Pearl	7 756 87						
Comfort thermostat with LED (supplied with central cover)	White	7 758 67		7 770 19	7 712 19	7 713 19	7 714 19	7 715 19
	Dark Bronze	7 756 92						
	Aluminium	7 756 93						
	Titanium	7 756 94						
	Pearl	7 756 95						
Thermostat for floor heating with LED (supplied with central cover)	White	7 758 58						
	Dark Bronze	7 756 88						
	Aluminium	7 756 89						
	Titanium	7 756 90						
	Pearl	7 756 91						
<b>BUZZERS AND CHIMES</b>								
Buzzer 230 V - 50 Hz with Anthracite central cover plate	7 757 11		7 770 19	7 712 19	7 713 19	7 714 19	7 715 19	
Buzzer 230 V - 50 Hz with White central cover plate	7 757 12							
Electronic chime 8/12 V - 50/60 Hz with Anthracite central cover plate	7 757 10							
Electronic chime 8/12 V - 50/60 Hz with White central cover plate	7 757 09							
Electronic chime 230 V with Anthracite central cover plate	7 757 17							
Electronic chime 230 V with White central cover plate	7 757 18							
<b>TELEPHONE SOCKETS, DATA SOCKETS</b>								
RJ 11 socket	7 759 38		7 770 95	7 712 95	7 713 95	7 714 95	7 715 95	

# Galea™ Life

## rocker or cover plate selection charts (continued)

Mechanisms			Rocker or cover plates				
			White 	Dark Bronze 	Soft Aluminium 	Titanium 	Pearl 
<b>TELEPHONE SOCKETS, DATA SOCKETS (continued)</b>							
Double RJ 11 socket	7 759 39						
Special ISDN RJ 45 socket	7 759 37						
Double RJ 45/RJ 11 VDI socket	7 757 81						
RJ 45 socket UTP, cat. 5e, screw, 1 connector	7 757 61						
RJ 45 socket UTP, cat. 5e, screw, 2 connectors	7 757 62						
RJ 45 socket UTP, cat. 5e, claw, 1 connector	7 757 65						
RJ 45 socket UTP, cat. 5e, claw, 2 connectors	7 757 66		7 770 75	7 712 75	7 713 75	7 714 75	7 715 75
RJ 45 socket UTP, cat. 6, screw, 1 connector	7 758 28						
RJ 45 socket UTP, cat. 6, screw, 2 connectors	7 758 30						
RJ 45 socket FTP, cat. 6, screw, 1 connector	7 757 98						
RJ 45 socket FTP, cat. 6, screw, 2 connectors	7 757 99						
RJ 45 socket UTP, cat. 6, claw, 1 connector	7 758 47						
RJ 45 socket UTP, cat. 6, claw, 2 connectors	7 758 23						
RJ 45 socket STP, cat. 6, screw, 1 connector	7 757 67		7 770 84	7 712 84	7 713 84	7 714 84	7 715 84
RJ 45 socket STP, cat. 6, screw, 2 connectors	7 757 68						
Adaptor for AMP data socket	7 758 85		7 770 76	7 712 76	7 713 76	7 714 76	7 715 76
<b>TELEVISION SOCKETS</b>							
Single TV socket 2400 MHz star architecture	7 759 65						
Single TV socket 2400 MHz terminal	7 759 66		7 770 66	7 712 66	7 713 66	7 714 66	7 715 66
Single TV socket 2400 MHz through-wiring	7 759 67						
Single TV socket "F" star architecture	7 756 80						
TV-R socket 862 MHz star architecture	7 757 86						
TV-R socket 862 MHz terminal	7 757 87		7 710 72	7 712 72	7 713 72	7 714 72	7 715 72
TV-R socket 862 MHz through-wiring	7 757 88						
TV-R SAT socket 2400 MHz star architecture	7 757 89						
TV-R SAT socket 2400 MHz terminal	7 757 90		7 710 73	7 712 73	7 713 73	7 714 73	7 715 73
TV-R SAT socket 2400 MHz through-wiring	7 757 91						







# Galea™ Life

## rocker or cover plate selection charts (continued)

Mechanisms			Rocker or cover plates				
			White 	Dark Bronze 	Soft Aluminium 	Titanium 	Pearl 
<b>SOCKET OUTLETS</b>							
<b>2P socket</b>	7 759 16	Standard 	7 770 26	7 712 26	7 713 26	7 714 26	7 715 26
		With safety shutters 	7 770 25	7 812 25	7 813 25	7 814 25	7 815 25
<b>2P+E, German standard, screw terminals</b>	7 759 21		7 770 20	7 712 20	7 713 20	7 714 20	7 715 20
<b>2P+E, German standard, automatic terminals</b>	7 759 20						
<b>2P+E, German standard, screw terminals</b>	7 759 21		7 770 21	7 712 21	7 713 21	7 714 21	7 715 21
<b>2P+E, German standard, automatic terminals</b>	7 759 20						
<b>2P+E, German standard, screw terminals</b>	7 759 21		7 770 22	7 712 22	7 713 22	7 714 22	7 715 22
<b>2P+E, German standard, automatic terminals</b>	7 759 20						
<b>2P+E, German standard tamperproof, screw terminals</b>	7 759 30		Red cover plate 7 770 29				
<b>2P+E, German standard, screw terminals</b>	7 759 21		7 770 79	Green 7 710 44	Orange 7 710 45	Red 7 710 46	Orange 7 770 42
<b>2P+E, German standard, automatic terminals</b>	7 759 20						
<b>2P+E, German standard with mechanical plug ejection</b>	Mechanism supplied with cover plate		7 770 24	7 712 24	7 713 24	7 714 24	7 715 24
<b>2P+E, German standard with indicator lamp cover plate and safety shutters</b>	Mechanism supplied with cover plate		7 710 48	Green 7 710 44	Orange 7 710 45	Red 7 710 46	Yellow 7 710 47
<b>2P Euro US standard</b>	7 758 36		7 770 19	7 712 19	7 713 19	7 714 19	7 715 19
<b>2P+E Euro US standard</b>	7 758 37						
<b>2P+E US standard</b>	7 758 38						
<b>BS standard socket unswitched</b>	7 758 49		7 770 96	7 712 96	7 713 96	7 714 96	7 715 96
<b>2P+E, BS standard switched socket with safety shutters</b>	7 758 48						



# Galea™ Life

## plate selection charts

Plates					
	1 gang	2 gang	2 gang	3 gang	3 gang
<b>White</b> 	7 710 01/ 7 710 13 <sup>(1)</sup>	7 710 02/ 7 710 14 <sup>(1)</sup>	7 710 06	7 710 03/ 7 710 15 <sup>(1)</sup>	7 710 07
<b>Dark Bronze</b> 	7 712 01	7 712 02	7 712 06	7 712 03	7 712 07
<b>Soft Aluminium</b> 	7 713 01	7 713 02	7 713 06	7 713 03	7 713 07
<b>Titanium</b> 	7 714 01	7 714 02	7 714 06	7 714 03	7 714 07
<b>Pearl</b> 	7 715 01	7 715 02	7 715 06	7 715 03	7 715 07
<b>Metal Magic Red</b> 	7 719 01	7 719 02	7 719 06	7 719 03	7 719 07
<b>Metal Magic Blue</b> 	7 719 11	7 719 12	7 719 16	7 719 13	7 719 17
<b>Metal Magic Green</b> 	7 719 21	7 719 22	7 719 26	7 719 23	7 719 27
<b>Metal Chrome</b> 	7 719 31	7 719 32	7 719 36	7 719 33	7 719 37
<b>Metal Black Nickel</b> 	7 719 41	7 719 42	7 719 46	7 719 43	7 719 47
<b>Metal Brushed Aluminium</b> 	7 719 51	7 719 52	7 719 56	7 719 53	7 719 57
<b>Maple</b> 	7 719 61	7 719 62	7 719 66	7 719 63	7 719 67
<b>Cherry wood</b> 	7 719 71	7 719 72	7 719 76	7 719 73	7 719 77
<b>Mahogany</b> 	7 719 81	7 719 82	7 719 86	7 719 83	7 719 87
<b>Leather Havanna</b> 	7 719 90	7 719 91	7 719 93	7 719 92	7 719 94
<b>Leather Club</b> 	7 719 95	7 719 96	7 719 98	7 719 97	7 719 99

# Galea™ Life

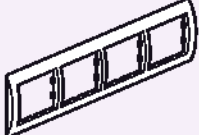
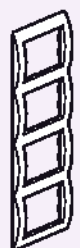
## plate selection charts (continued)

<b>Plates</b>  	 <b>4 gang</b>	 <b>4 gang</b>	 <b>5 gang</b>	 <b>5 gang</b>
<b>White</b> 	7 710 04	7 710 08	7 710 05	7 710 09
<b>Dark Bronze</b> 	7 712 04	7 712 08	7 712 05	7 712 09
<b>Soft Aluminium</b> 	7 713 04	7 713 08	7 713 05	7 713 09
<b>Titanium</b> 	7 714 04	7 714 08	7 714 05	7 714 09
<b>Pearl</b> 	7 715 04	7 715 08	7 715 05	7 715 09
<b>Metal Magic Red</b> 	7 719 04	7 719 08	7 719 05	7 719 09
<b>Metal Magic Blue</b> 	7 719 14	7 719 18	7 719 15	7 719 19
<b>Metal Magic Green</b> 	7 719 24	7 719 28	7 719 25	7 719 29
<b>Metal Chrome</b> 	7 719 34	7 719 38	7 719 35	7 719 39
<b>Metal Black Nickel</b> 	7 719 44	7 719 48	7 719 45	7 719 49
<b>Metal Brushed Aluminium</b> 	7 719 54	7 719 58	7 719 55	7 719 59
<b>Maple</b> 	7 719 64	7 719 68	7 719 65	7 719 69
<b>Cherry wood</b> 	7 719 74	7 719 78	7 719 75	7 719 79
<b>Mahogany</b> 	7 719 84	7 719 88	7 719 85	7 719 89

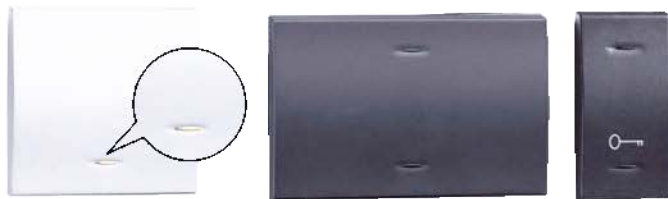
 6 870 67  
All control units with diffusers

6 827 61

6 827 62

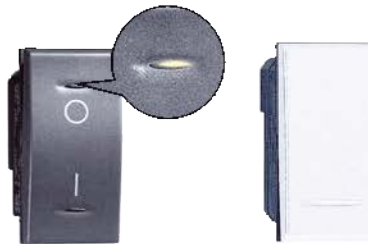
 6 827 40  
All control units with diffusers

6 870 01

Pack	Cat.Nos	<b>Rocker plates without marking</b>
		For switches and push-buttons
		<b>1 module</b>
100	6 829 13	● Anthracite
100	6 870 59	○ Shiny White
		<b>2 modules</b>
5	6 827 60	● Anthracite
5	6 870 67	○ Shiny white
		<b>3 modules</b>
5	6 827 61	● Anthracite
5	6 870 68	○ Shiny white





**Rocker plates with marking**

 For switches and push-buttons  
1 module

- With "key" symbol**
- 
- 5 6 827 62 ● Anthracite
- 
- 5 6 870 63 ○ Shiny white

- With "bell" symbol**
- 
- 5 6 827 63 ● Anthracite
- 
- 5 6 870 61 ○ Shiny white

- With "lamp" symbol**
- 
- 5 6 827 64 ● Anthracite
- 
- 5 6 870 62 ○ Shiny white

- With "ON-OFF" marking**
- 
- 5 6 830 18 ● Anthracite
- 
- 5 6 870 60 ○ Shiny white

**Cover plate for Italian type socket outlets**

1 module

- For 10/16 A socket outlets**
- 
- 10 6 830 11 ● Red - dedicated

**Blanking plates**

- 1 module**
- 
- 50 6 827 69 ● Anthracite
- 
- 50 6 870 50 ○ Shiny white

- 1/2 module**
- 
- 10 6 830 17 ● Anthracite
- 
- 10 6 870 58 ○ Shiny white

**Cord outlets**

- With Ø9 mm entry
- 
- 10 6 827 70 ● Anthracite
- 
- 10 6 870 53 ○ Shiny white

**Lamp**

- 1 6 830 26 230 V - orange

 Support frame and plate selection charts **p. 490-491**

Mechanisms equipped with rocker plates, to be equipped with plates (p. 490-491)

Pack	Cat.Nos	<b>Single pole switches 10 A - 250 V~</b>
		1 module
		<b>Single pole one-way switch</b>
		Can be illuminated with lamp Cat.No 6 830 26
10	6 830 76	● Anthracite
10	6 870 01	○ Shiny White
		<b>Single pole two-way switch</b>
		Can be illuminated with lamp Cat.No 6 830 26
10	6 830 77	● Anthracite
10	6 870 03	○ Shiny white
		<b>Single pole intermediate switch</b>
		Can be illuminated with lamp Cat.No 6 830 26
10	6 830 78	● Anthracite
10	6 870 04	○ Shiny white



Pack	Cat.Nos	<b>Double pole switches 16 AX - 250 V~</b>
		1 module
		<b>Double pole one-way switch</b>
		Can be illuminated with lamp Cat.No 6 830 26
10	6 827 40	● Anthracite
10	6 870 02	○ Shiny white

# Vela™

## push-buttons



Support frame and plate selection charts p. 490-491

Mechanisms equipped with rocker plates, to be equipped with plates (p. 490-491)

Pack	Cat.Nos	Push-buttons 10 A - 250 V~
		1 module
1	6 827 34	<b>1P - N/C contact</b> Can be illuminated with lamp Cat.No 6 830 26 (p. 484)
1	6 870 06	● Anthracite ○ Shiny White
		<b>1P - N/O contact</b> Can be illuminated with lamp Cat.No 6 830 26 (p. 484)
10	6 830 79	● Anthracite
10	6 870 05	○ Shiny white
		<b>2P - N/O contact</b> Can be illuminated with lamp Cat.No 6 830 26 (p. 484)
1	6 830 00	● Anthracite
1	6 870 09	○ Shiny white
		<b>1P illuminated with orange diffuser - N/O contact</b>
1	6 830 01	● Anthracite
1	6 870 10	○ Shiny white
		<b>1P illuminated with transparent diffuser - N/O contact</b>
1	6 827 50	● Anthracite
1	6 870 11	○ Shiny white
		<b>1P illuminated with red diffuser - N/O contact</b>
1	6 827 48	● Anthracite
1	6 870 12	○ Shiny white
		<b>1P illuminated with green diffuser - N/O contact</b>
1	6 827 49	● Anthracite
1	6 870 14	○ Shiny white
		<b>Double push-buttons 10 A - 250 V~</b>
1	6 827 45	<b>1P + 1P N/O contact with interlock</b>
1	6 870 18	● Anthracite ○ Shiny white
1	6 827 54	<b>1P + 1P N/O contact without interlock</b>
1	6 870 08	● Anthracite ○ Shiny white
		<b>Push-button with label-holder 10 A - 250 V~</b>
1	6 831 54	2 modules 1P - N/O contact

# Vela™

## dimmers, automatic switches



Support frame and plate selection charts p. 490-491

Mechanisms equipped with cover plates, to be equipped with plates (p. 490-491)

Pack	Cat.Nos	Dimmers 230 V~
		1 module
		<b>60 - 500 W</b> For incandescent and halogen lamps With integrated fuse With two-way switch incorporated
1	6 827 21	● Anthracite
1	6 873 21	○ Shiny White
		<b>100 - 500 W</b> For incandescent and halogen lamps
1	6 827 22	● Anthracite
1	6 873 22	○ Shiny white
		<b>Push-button dimmers 230 V~</b>
		2 modules
		<b>60 - 500 W</b> For incandescent and halogen lamps and ELV halogen lamps with ferromagnetic transformers With integrated fuse With incorporated two-way switch
1	6 827 23	● Anthracite
1	6 873 23	○ Shiny white
		<b>Automatic IR switches 230 V~</b>
		With passive infrared movement sensor Twilight circuit with variable threshold and possibility of continuous "on" Programmable circuit for delayed switch-off adjustable from 30 seconds to 10 minutes
		<b>For resistive/inductive loads up to 2 A</b>
		1 module
1	6 827 27	● Anthracite
1	6 873 27	○ Shiny white



6 870 15



6 827 46

 Support frame and plate selection charts **p. 490-491**

Mechanisms equipped with cover plates, to be equipped with plates (p. 490-491)

Pack	Cat.Nos	<b>Selector switches</b>
		<b>2 positions - 1-0-2</b>
		Can be illuminated with lamp Cat.No 6 830 26 (p. 484)
		1 module
1	6 827 44	● Anthracite
1	6 870 15	○ Shiny white
		<b>4-position speed controller</b>
		For fans, fan-coils...
		2 modules
1	6 827 36	● Anthracite
1	6 870 17	○ Shiny white
		<b>Pull-cord push-buttons 10 A - 250 V~</b>
		1 module
		<b>1P - N/O contact</b>
1	6 827 46	● Anthracite
1	6 870 07	○ Shiny white



6 830 07



6 827 77

 Support frame and plate selection charts **p. 490-491**

Mechanisms equipped with cover plates, to be equipped with plates (p. 490-491)

Pack	Cat.Nos	<b>Italian type socket outlets 250 V~</b>
		1 module
		<b>10 A</b>
10	6 830 80	● Anthracite
10	6 870 13	○ Shiny white
		<b>10/16 A</b>
10	6 830 81	● Anthracite
10	6 870 80	○ Shiny white
		<b>German standard socket outlets 250 V~</b>
		2 modules
		<b>2P+⊥ - 16 A</b>
10	6 830 05	● Anthracite
10	6 870 41	○ Shiny white
10	6 830 07	● Red - dedicated
		<b>Italian type/German standard socket outlets 250 V~</b>
		2 modules
		<b>2P+⊥ - 16 A - Type 30</b>
10	6 827 74	● Anthracite
10	6 870 40	○ Shiny white
5	6 828 75	● Red - dedicated
		<b>2P+⊥ - 10/16 A</b>
10	6 827 77	● Anthracite
10	6 870 16	○ Shiny white
5	6 829 18	● Red - dedicated
		<b>Euro/US standard socket outlets 250 V~</b>
		2 modules
		<b>2P - 10/16 A</b>
10	6 829 31	● Anthracite
		<b>Israeli standard socket outlets 250 V~</b>
		2 modules
		<b>2P+⊥ - 10/16 A</b>
10	6 830 10	● Anthracite
10	6 870 69	○ Shiny white



## Vela™

### telephone, data sockets



6 827 87



6 870 82

Support frame and plate selection charts **p. 490-491**

Mechanisms equipped with cover plates, to be equipped with plates (p. 490-491)

Pack	Cat.Nos	Telephone sockets
1	6 827 87	RJ 11 1 module ● Anthracite
1	6 870 25	○ Shiny white
		<b>Tool-less RJ 45 data sockets</b>
		Conform to standards: ISO 11801 ed. 2.0 EN 50 173 EIA/TIA 568 Fast connection sockets. No tool required Contacts marked with dual colour code T 568 A - T 568 B and numbers Possible re-wire in case of eventual error 1 module
10	6 830 33	<b>Cat. 5e - UTP</b> ● Anthracite
10	6 870 82	○ Shiny white
10	6 830 36	<b>Cat. 6 - UTP</b> ● Anthracite
10	6 870 85	○ Shiny white
10	6 830 38	<b>Cat. 6 - FTP</b> ● Anthracite
10	6 870 87	○ Shiny white

## Vela™

### television sockets



6 827 83



6 870 36



6 827 81



6 870 30

Support frame and plate selection charts **p. 490-491**

Mechanisms equipped with cover plates, to be equipped with plates (p. 490-491)

Pack	Cat.Nos	TV-R-SAT sockets
1	6 827 83	Single shielded coaxial socket for single user aerial TV systems, including remotely powered and centralised systems, single user and centralised satellite systems with current and signal transition for channel selection and radio systems Male TV connector terminal Ø9.5 mm Female SAT and radio connector Ø9.5 mm It is recommended to use the three sockets at the same time 2 modules
1	6 870 34	● Anthracite ○ Shiny White
		<b>TV-SAT sockets</b>
		<b>Female coaxial connector type "F", 75 Ω</b> Screw terminals 1 module
10	6 827 59	● Anthracite
10	6 870 36	○ Shiny white
		<b>TV-SAT demixed sockets</b> Shunted demixed TV-SAT jack in die-cast housing 1 module
1	6 830 13	● Anthracite
1	6 870 35	○ Shiny white
		<b>TV sockets</b> Coaxial sockets Shielded connector terminals with captive screws Ø9.5 mm - male connector 1 module
		<b>Single shielded</b> For single user aerial systems, including remotely powered and centralised systems with current and signal transition for channel selection
10	6 827 81	● Anthracite
10	6 870 30	○ Shiny White
		<b>Single shielded with capacitor</b> For single user aerial or centralised systems Shielded connector terminals with captive screws - for non remotely powered or centralised satellite systems
1	6 827 82	● Anthracite
1	6 870 33	○ Shiny white
		<b>Throughwiring shielded</b> For aerial systems, including remotely powered and centralised systems and centralised satellite systems with current and signal transition for channel selection
1	6 827 80	● Anthracite
1	6 870 31	○ Shiny white
		<b>Terminal shielded</b> For aerial systems, including remotely powered and centralised systems and centralised satellite systems with current and signal transition for channel selection With integrated 75 W impedance adaptor
1	6 827 79	● Anthracite
1	6 870 32	○ Shiny white

## Vela™

### audible and visual indication



Support frame and plate selection charts p. 490-491

Mechanisms equipped with cover plates, to be equipped with plates (p. 490-491)

Pack	Cat.Nos	Buzzers
		1 module
		<b>12 V~ - 5 VA</b>
		74 dB
1	6 829 00	● Anthracite
1	6 870 44	○ Shiny White
		<b>230 V~ - 8 VA</b>
		75 dB
1	6 829 01	● Anthracite
1	6 870 45	○ Shiny white
		<b>Bells (bronze striker)</b>
		80 dB - 1 module
		<b>12 V~ - 5 VA</b>
		● Anthracite
1	6 829 02	○ Shiny white
1	6 870 42	○ Shiny white
		<b>230 V~ - 8 VA</b>
		● Anthracite
1	6 829 03	○ Shiny white
1	6 870 43	○ Shiny white
		<b>Emergency light units - 230 V~</b>
		<b>Emergency light unit</b>
		With automatic switch-on
		With rechargeable base - high output white LED
		Interchangeable Ni-MH batteries without "memory" effect - 2-hour autonomy
		Low consumption in stand-by mode (0.4 W)
		2 modules
1	6 829 17	● Anthracite
1	6 873 17	○ Shiny white
		<b>Guide lamp 230 V</b>
		2 modules
1	6 827 26	With adjustable beam direction
		<b>Indicator units</b>
		Lamp not supplied - 1 module
		<b>Single unit</b>
		With interchangeable diffusers (green - red - orange transparent)
1	6 827 98	● Anthracite
1	6 870 46	○ Shiny white
		<b>Shaver sockets</b>
		With isolation transformer
		Input voltage 230 V~ - 50/60 Hz
		Output voltage 115/230 V~ - 20 VA
		With integrated support
		3 modules
1	6 830 12	● Anthracite
1	6 870 24	○ Shiny white

## Vela™

### MCBs and RCBOs



Support frame and plate selection charts p. 490-491

Mechanisms equipped with cover plates, to be equipped with plates (p. 490-491)

Pack	Cat.Nos	MCBs
		2 pole thermal-magnetic devices with one protected pole (C curve)
		Positive contact indication
		1 module
		<b>6 A - 230 V~ - Breaking capacity: 1500 A</b>
		● Anthracite
1	6 829 04	○ Shiny White
1	6 870 51	○ Shiny White
		<b>10 A - 230 V~ - Breaking capacity: 3000 A</b>
		● Anthracite
1	6 829 05	○ Shiny white
1	6 870 52	○ Shiny white
		<b>16 A - 230 V~ - Breaking capacity: 3000 A</b>
		● Anthracite
1	6 829 06	○ Shiny white
1	6 870 54	○ Shiny white
		<b>RCBOs</b>
		Single pole and neutral
		10 mA
		Residual current circuit breaker with overcurrent protection C curve
		Positive contact indication
		Breaking capacity: 3000 A
		2 modules
		<b>6 A - 230 V~</b>
		● Anthracite
1	6 829 07	○ Shiny white
1	6 870 55	○ Shiny white
		<b>10 A - 230 V~</b>
		● Anthracite
1	6 829 08	○ Shiny white
1	6 870 56	○ Shiny white
		<b>16 A - 230 V~</b>
		● Anthracite
1	6 829 09	○ Shiny white
1	6 870 57	○ Shiny white
		<b>Fuse carriers</b>
		For fuses 5 x 20 - 6.3 x 32 max.
		10 A - 250 V
		1 module
		● Anthracite
1	6 829 10	○ Shiny white
1	6 870 48	○ Shiny white

# Vela™

## support frames, flush-mounting boxes and surface mounting boxes



0 728 43



0 801 41





0 892 39











6 806 33

Support frame and plate selection charts p. 490-491



Pack	Cat.Nos	SPX support frames		Pack	Cat.Nos	Plexo modular support frames IP 55 - IK 07
10	0 728 42	Screw-mounting For 2 modules Can also be used as claw-mounting				Weatherproof IP 55 with membrane Allows operations of switches without opening cover maintaining IP 55 rating
100	0 728 43	For 3 modules		1	6 806 32	<b>For 3-module Vela mechanisms</b>  ○ White ● Grey
10	0 728 44	For 4 modules		1	6 806 33	
10	0 728 46	For 6 modules		1	6 806 34	<b>For 4-module Vela mechanisms</b>  ○ White ● Grey
1	6 826 71	For 6 + 6 modules		1	6 806 35	
		<b>Flush-mounting boxes</b>				<b>Weatherproof surface-mounting boxes IP 55</b>
10	0 801 40	<b>For 1 module</b> Depth 40 mm - Width 32 mm		1	6 806 11	To be equipped with Vela mechanisms (support frame not needed)
		<b>Square boxes for joining together</b> For wiring accessories using screws or claws 1-gang boxes can be used to make up multi-gang boxes by joining Can be used horizontally or vertically 71 mm fixing centres Cutting out of internal partitions for mounting extended functions Supplied with screws fitted with protective shield		1	6 806 12	For 1 Vela module
100	0 801 41	Knockout cable entries, Ø16-20-255 Depth 40 mm		1	6 806 13	For 2 Vela modules
		<b>Round for joining together back to back</b> Upper flange can be cut to obtain a depth of 30 mm (for controls, 2-way switches, push-buttons, etc.) Boxes can be joined back to back by 1/4 of a turn Adjustable dimensions (80, 70 or 60 mm) by cutting the flange With screws		1	6 806 14	For 3 Vela modules
100	0 801 08	Depth 40 mm - Ø67 mm		1	6 806 15	For 4 Vela modules
		<b>Multi-gang boxes</b> For screw or claw mounting devices Supplied without screws Horizontal mounting Depth 50 mm		5	6 806 16	For 8 Vela modules (2 ranges of 4 modules)
5	0 892 39	For 3 modules - 106 x 71 mm		1	6 806 01	<b>Weatherproof surface-mounting boxes IP 40</b>
5	0 892 49	For 4 modules - 130 x 71 mm		1	6 806 02	To be equipped with Vela mechanisms (support frame not needed)
1	0 892 50	For 6 modules - 186 x 71 mm		1	6 806 03	For 1 Vela module
1	6 826 70	For 6 + 6 modules		1	6 806 04	For 2 Vela modules
				1	6 806 05	For 3 Vela modules
				5	6 806 06	For 4 Vela modules
				5	6 806 07	For 6 Vela modules - horizontal mounting
				5	6 806 08	For 8 Vela modules - horizontal mounting
				5	6 806 09	For 8 Vela modules - vertical mounting

Number of modules per mechanism	Flush-mounting boxes	Support frames	Plates	TONDA PLATES					
				Neutral		Hearts		Metallic	
				White 	Anthracite 	Malt 	Brown 	White 	Steel 
<b>2 modules</b>	0 801 41 0 801 08	0 728 42		6 856 00	6 858 14	6 857 75	6 856 15	6 858 26	6 858 18
<b>3 modules</b>	0 892 39	0 728 43		6 856 01	6 858 15	6 857 76	6 856 16	6 858 27	6 858 19
<b>4 modules</b>	0 892 49	0 728 44		6 856 02	6 858 16	6 857 77	6 856 17	6 858 28	6 858 20
<b>6 modules</b>	0 892 50	0 728 46		6 856 03	6 858 17	6 857 82	6 856 18	6 858 29	6 858 21
				QUADRA PLATES					
				Neutral				Reflex Intense Colour	
				Shiny White 	Anthracite 	Ivory 	100% cocoa 	Intense Red 	Blue Colbalt 
<b>2 modules</b>	0 801 41 0 801 08	0 728 42		6 856 40	6 826 01	6 857 99	6 858 04	6 856 50	6 856 55
<b>3 modules</b>	0 892 39	0 728 43		6 856 41	6 826 16	6 858 00	6 858 05	6 856 51	6 856 56
<b>4 modules</b>	0 892 49	0 728 44		6 856 42	6 826 31	6 858 01	6 858 06	6 856 52	6 856 57
<b>6 modules</b>	0 892 50	0 728 46		6 856 43	6 826 46	6 858 02	6 858 07	6 856 53	6 856 58

Number of modules per mechanism	Flush-mounting boxes	Support frames	Plates	BASIC PLATES
				White 
<b>1 module</b>	0 801 08 0 801 41	0 728 42		6 805 30
<b>2 modules</b>				6 805 31
<b>1 module centered</b>	0 892 39	0 728 43		6 805 41
<b>2 modules centered</b>				6 805 42
<b>3 modules</b>				6 805 43
<b>4 modules</b>	0 892 49	0 728 44		6 805 44
<b>6 modules</b>	0 892 50	0 728 46		6 805 49

TONDA PLATES							
Technical Wood	Shiny		Satin finish		Striped Metal		
Teak	Chrome	Gold	Aluminium	Gold	Aluminium	Copper	
							
6 856 20	6 858 30	6 858 34	6 856 35	6 856 30	6 858 38	6 858 46	
6 856 21	6 858 31	6 858 35	6 856 36	6 856 31	6 858 39	6 858 47	
6 856 22	6 858 32	6 858 36	6 856 37	6 856 32	6 858 40	6 858 48	
6 856 23	6 858 33	6 858 37	6 856 38	6 856 33	6 858 41	6 858 49	

QUADRA PLATES						
Technical Wood	Reflex Light Colour			Metallised		
Wenge	Bright White	Grey Water	Pink Peach	Silver	Copper	Pearl
						
6 856 65	6 857 15	6 857 20	6 856 95	6 857 45	6 857 70	6 857 55
6 856 66	6 857 16	6 857 21	6 856 96	6 857 46	6 857 71	6 857 56
6 856 67	6 857 17	6 857 22	6 856 97	6 857 47	6 857 72	6 857 57
6 856 68	6 857 18	6 857 23	6 856 98	6 857 48	6 857 73	6 857 58

Number of modules per mechanism	Flush-mounting boxes	Support frames	Plates	QUADRA - COMMERCIAL USE	
				Anthracite	White
1 module	0 801 40	not needed		6 826 76	6 870 73
2 modules	2 x 0 801 40	not needed		6 826 78	6 870 74
2 x 6 modules	6 826 70	6 826 71		6 826 73	6 870 72



# BRITISH STANDARD WIRING ACCESSORIES



**P. 494**  
Switches and  
push-buttons

## Belanko™



**P. 497**  
Socket  
outlets

## Mallia™ complete white



**P. 500**  
Switches and  
push-buttons

## Mallia™ customisable colours



**P. 507**  
Switches and  
push-buttons  
and other  
lighting functions



**P. 516**  
Front plates  
for Arteor  
mechanisms

## Synergy™



**P. 534**  
Synergy  
Flat plate

## NEW PRODUCTS 2014



**Belanko™**  
RJ 11 + RJ 45  
socket  
(p. 496)



**Belanko™**  
Double female TV  
socket  
(p. 496)



**P. 495**  
Dimmers and  
ventilation control



**NEW**  
**P. 496**  
Television, telephone  
and data sockets



**P. 496**  
Hotel equipment



**P. 497**  
Fused connection  
units



**P. 498**  
Cable outlets  
and boxes



**P. 498**  
Plates



**P. 502**  
Dimmers, automatic  
switches, other  
lighting functions



**P. 503**  
Telephone, data  
and television sockets



**P. 504**  
Socket outlets



**P. 506**  
Hotel equipment



**P. 510**  
Telephone, data  
and television  
sockets



**P. 511**  
Socket outlets



**P. 513**  
Hotel equipment



**P. 514**  
Plates



**P. 517**  
Synergy white



**P. 522**  
Synergy Modern



**P. 528**  
Synergy  
Traditional



**P. 540**  
Synergy Metalclad



**P. 542**  
Synergy  
Grid system  
for Grid modules



**P. 544**  
Synergy  
Grid modules



**Belanko™**  
Arteor adaptor  
(p. 498)

# Belanko™

## single pole switches and push-buttons



6 171 00



6 171 08



6 170 00

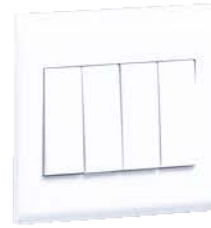

6 170 06



6 171 15

Colour: White T084

Material: Thermoplastic with glossy finish

Dimensions: 86 x 86 x 9.5 mm (1 gang) / 86 x 146 x 9.5 mm (2 gang)

Supplied with 2 screws M3.5 for BS boxes

### Pack Cat.Nos Single pole switches 10 AX - 250 V~

Pack	Cat.Nos	Description
		Conform to BS EN 60669-1
		<b>Small rocker</b>
10	6 171 00	1 gang - 1-way switch
10	6 171 01	1 gang - 2-way switch
10	6 171 02	2 gang - 1-way switch
10	6 171 03	2 gang - 2-way switch
10	6 171 04	3 gang - 1-way switch
10	6 171 05	3 gang - 2-way switch
10	6 171 06	4 gang - 1-way switch
10	6 171 07	4 gang - 2-way switch
10	6 171 08	5 gang - 1-way switch
5	6 171 10	6 gang - 1-way switch
10	6 171 09	Intermediate switch
		<b>Large rocker</b>
10	6 170 00	1 gang - 1-way switch
10	6 170 01	1 gang - 2-way switch
10	6 170 02	2 gang - 1-way switch
10	6 170 03	2 gang - 2-way switch
10	6 170 04	3 gang - 1-way switch
10	6 170 05	3 gang - 2-way switch
10	6 170 06	4 gang - 1-way switch
10	6 170 07	4 gang - 2-way switch
10	6 170 09	Intermediate switch

### Pack Cat.Nos Single pole switches 20 AX - 250 V~

Pack	Cat.Nos	Description
		Conform to BS EN 60669-1
		<b>Large rocker</b>
10	6 170 20	1 gang - 1-way
10	6 170 21	1 gang - 2-way
10	6 170 22	2 gang - 1-way
10	6 170 23	2 gang - 2-way
		<b>Architraves</b>
5	6 171 15	1 gang - 1-way
5	6 171 16	Bell push
		<b>Push-buttons 4 A - 250 V~</b>
		Conform to BS EN 60669-1
		<b>Small rocker</b>
10	6 171 11	Bell push
		<b>Large rocker</b>
10	6 170 11	Bell push





## Belanko™

### double pole switches and cooker control unit



6 170 72



6 170 76

Colour: White T084

Material: Thermoplastic with glossy finish

Dimensions: 86 x 86 x 9.5 mm (1 gang) / 86 x 146 x 9.5 mm (2 gang)

Supplied with 2 screws M3.5 for BS boxes

Pack	Cat.Nos	Double pole switches
10	6 170 70	20 A - 250 V~ 1 gang - 1-way switch + red neon indicator + earth connection
10	6 170 71	
10	6 170 72	1 gang - 1-way switch + red neon indicator + earth connection with "Water Heater" marking
10	6 170 74	32 A - 250 V~ 1 gang - 1-way switch + red neon indicator, white rocker
10	6 170 75	45 A - 250 V~ 1 gang - 1-way switch
10	6 170 76	1 gang - 1-way switch + red neon indicator
5	6 170 77	2 gang - 1-way vertical switch + red neon indicator
5	6 170 78	Cooker control Unit - 250 V 45 A DP switch + red neon and 13 BS switched socket outlet + red neon

## Belanko™

### dimmers and ventilation control



6 170 31



6 170 33



Technical characteristics [e-catalogue](#)

Colour: White T084

Material: Thermoplastic with glossy finish

Dimensions: 86 x 86 x 9.5 mm (1 gang) / 86 x 146 x 9.5 mm (2 gang)

Supplied with 2 screws M3.5 for BS boxes

Pack	Cat.Nos	Dimmers
1	6 170 30	Rotary on/off dimmer - 50 Hz 1 gang - 1-way 40-600 W (230 V) for incandescent and halogen lamps
1	6 170 31	Push on/off and rotary dimmer - 50/60 Hz 1 gang - 2-way 60-1000 W (230 V) - 60-500 W (127 V) for incandescent and halogen lamps 60-600 VA (230 V) 60-300 VA (127 V) for halogen lamps with electronic transformer with leading edge behaviour 60-1000 VA (230 V) - 60-500 VA (127 V) for halogen lamps with ferromagnetic transformers
1	6 170 32	Push on/off and rotary dimmer - 50/60 Hz 1 gang - 2-way 60-1500 W (230 V) - 60-750 W (127 V) for incandescent and halogen lamps 60-900 VA (230 V) - 60-450 VA (127 V) for halogen lamps with electronic transformer with leading edge behaviour 60-1500 VA (230 V) - 60-750 VA (127 V) for halogen lamps with ferromagnetic transformers Can be mounted on 1 gang or 2 gang boxes
1	6 170 33	Ventilation control Conform to BS EN 60669-1 Fan control 250 V~ 50 Hz



For technical characteristics,  
see [e-catalogue](#)





Colour: White T084  
 Material: Thermoplastic  
 Dimensions: 86 x 86 x 9.5 mm (1 gang) / 86 x 146 x 9.5 mm (2 gang)  
 Supplied with 2 screws M3.5 for BS boxes

Pack	Cat.Nos	Television sockets
10	6 171 21	Single TV socket, female
10	6 171 20	Single TV socket, "F" type
10	6 171 23	Double TV socket, female + "F" type
10	6 171 27	Double female TV socket
<b>Telephone sockets</b>		
10	6 170 99	Telephone connection block 10 connections
10	6 170 95	BT master
10	6 170 96	BT secondary
10	6 170 97	RJ 11 socket
10	6 170 98	Double RJ 11 socket
10	6 170 94	RJ 11 + RJ 45 Cat.5e UTP socket
<b>Data sockets</b>		
10	6 170 90	RJ 45 Cat.5e UTP
10	6 170 91	RJ 45 Cat.6 UTP
10	6 170 92	Double RJ 45 Cat.6 UTP

Pack	Cat.Nos	Key card switch
1	6 170 12	16 A - 230 V - 50 Hz Time delay of approx. 30 s after card removal
<b>Hotel bedrooms call indicators</b>		
2 settings : - Do not disturb - Please clean the room		
10	6 170 13	Indicator lamp + bell push Installed in the corridor, display calls
10	6 170 14	Internal control unit Installed in the room, allows the user to select the desired setting
<b>Shaver socket</b>		
1	6 170 68	Conform to BS 61558 115/230 V - 20 VA - 50/60 Hz Surface or flush-mounting, back box to be min. 47 mm deep - 2 gang
<b>Security switch</b>		
1	6 170 19	1 A resistive - 250 V~ Panic button

# Belanko™

## socket outlets and fused connection units



Colour: White T084. Material: Thermoplastic with glossy finish  
 Dimensions: 86 x 86 x 9.5 mm (1 gang) / 86 x 146 x 9.5 mm (2 gang). Supplied with 2 screws M3.5 for BS boxes

Pack	Cat.Nos	British Standard socket outlets
		<b>13 A - 250 V~</b> Conform to BS 1363-2
10	6 170 40	1 gang unswitched
5	6 170 45	2 gang unswitched
10	6 170 41	1 gang single pole switched
10	6 170 43	1 gang double pole switched
5	6 170 46	2 gang single pole switched
5	6 170 48	2 gang double pole switched
10	6 170 42	1 gang single pole switched + neon
5	6 170 47	2 gang single pole switched + neon
10	6 171 41	1 gang single pole switched with external rocker
5	6 171 46	2 gang single pole switched with inboard rockers
5	6 170 49	2 gang single pole switched with red cover + neon
		<b>15 A - 250 V~</b> Conform to BS 546
10	6 170 50	1 gang unswitched
10	6 170 51	1 gang single pole switched
10	6 170 52	1 gang single pole switched + neon
5	6 170 53	2 gang single pole switch

Pack	Cat.Nos	British Standard socket outlets (continued)
		<b>5 A - 250 V~</b> Conform to BS 546
10	6 170 54	1 gang single pole switched
		<b>Euro/US socket outlets - 10 A - 250 V~ / 15 A - 127 V~</b>
10	6 170 60	1 gang - 2P
10	6 170 61	1 gang - 2P + 10 AX switch
10	6 170 62	1 gang - 2 x 2P
10	6 170 63	1 gang - 2P+E
		<b>US socket outlet - 15 A - 127 V~</b>
10	6 170 65	1 gang - 2P+E
		<b>German standard socket outlet 16 A - 250 V~</b>
10	6 170 56	1 gang - 2P+E with shutters for child protection
10	6 170 55	1 gang - 2P+E without shutters
		<b>Multistandard socket outlet</b>
10	6 170 67	Switched socket
		<b>Fused connection units</b>
		<b>13 A</b> Conform to BS 1363-4
10	6 170 80	Unswitched + cord outlet
10	6 170 81	Switched + cord outlet
10	6 170 82	Switched + neon + cord outlet

# Belanko™

cable outlets, surface-mounting boxes, plates and blanking plates



6 171 31 + 6 170 42



6 133 51



6 171 55



6 171 51

Pack	Cat.Nos	Cable outlets
10	6 170 85	Conform to BS 5733 20 A - 250 V~ 
10	6 170 86	45 A - 250 V~ 
100	6 171 30	Screw caps
2	6 171 31	Splash-proof cover Mainly for socket protection IP 44 with or without plug engaged Space inside : 86 x 86 mm (for Belanko, Mallia and Synergy products)
<b>Surface-mounting boxes</b>		
10	6 133 49	Conform to BS 5733 depth 35 mm Architrave surface box 
8	6 133 50	1 gang surface box - 86 x 86 mm Supplied with earth terminal 
4	6 133 51	2 gang surface box - 86 x 146 mm Supplied with earth terminal 

Pack	Cat.Nos	Plates
5	6 171 50	<b>1 gang - horizontal</b> Beige Taupe
5	6 171 55	
5	6 171 51	<b>1 gang - vertical</b> Beige Taupe
5	6 171 56	
5	6 171 52	<b>2 gang - horizontal</b> Beige Taupe
5	6 171 57	
5	6 171 53	<b>2 gang - vertical</b> Beige Taupe
5	6 171 58	
<b>Blanking plates</b>		
10	6 171 28	Conform to BS 5733 1 gang 
5	6 171 29	2 gang 
10	6 171 32	<b>Arteor adaptor</b> 1 gang 



# Mallia™

express yourself  
like never before

Mixing colours is a breeze with Mallia. Beyond promising endless possibilities with the expanded range, the license to blend them in anywhere desired is just sheer joy

## IT'S SIMPLE

### Complete white or customisable functions

- Mallia plates and gang units are interchangeable and easy to install
- Mallia goes the distance that ensures that form always complements the function



▶▶ 3 cover plates and 13 plate finishes



QR code for complete and customisable presentation



# Mallia™

## single pole switches - complete white



2 810 00



2 810 04



2 810 10



2 810 16

Conform to BS EN 60669 – 1  
 Polycarbonate front cover plates with a matt finish  
 Compact mechanism for a larger wiring space  
 Supplied with 2 screws M 3.5 for BS boxes  
 Supplied complete with plate  
 Dim.: 86 x 86 mm

Pack	Cat.Nos	Single pole standard switches 10 AX - 250 V~
10	2 810 00	<b>1 gang - 1-way switch</b> ○ White
10	2 810 01	<b>1 gang - 2-way switch</b> ○ White
4	2 810 08	<b>1 gang - intermediate switch</b> ○ White
10	2 810 02	<b>2 gang - 1-way switch</b> ○ White
10	2 810 03	<b>2 gang - 2-way switch</b> ○ White
10	2 810 04	<b>3 gang - 1-way switch</b> ○ White
10	2 810 05	<b>3 gang - 2-way switch</b> ○ White
10	2 810 06	<b>4 gang - 1-way switch</b> Compatible with metal boxes only, for installation fold the vertical lugs of the boxes ○ White
10	2 810 07	<b>4 gang - 2-way switch</b> Compatible with metal boxes only, for installation fold the vertical lugs of the boxes ○ White

Pack	Cat.Nos	Single pole illuminated switches 10 AX - 250 V~
Transparent phosphorescent lens To be equipped with green or red LED according to the needs: indicator or locator (p. 514) The LED is not supplied		
10	2 810 10	<b>1 gang - 1-way switch</b> ○ White
10	2 810 11	<b>1 gang - 2-way switch</b> ○ White
4	2 810 09	<b>1 gang - intermediate switch</b> ○ White
10	2 810 12	<b>2 gang - 1-way switch</b> ○ White
10	2 810 13	<b>2 gang - 2-way switch</b> ○ White
10	2 810 14	<b>3 gang - 1-way switch</b> ○ White
10	2 810 15	<b>3 gang - 2-way switch</b> ○ White
10	2 810 16	<b>4 gang - 1-way switch</b> Compatible with metal boxes only, for installation fold the vertical lugs of the boxes ○ White
10	2 810 17	<b>4 gang - 2-way switch</b> Compatible with metal boxes only, for installation fold the vertical lugs of the boxes ○ White

# Mallia™

## single pole switches and double pole switches - complete white



2 810 50



2 810 53



2 810 62



2 810 72

Conform to BS EN 60669 - 1  
 Polycarbonate front cover plates with a matt finish  
 Compact mechanism for a larger wiring space  
 Supplied with 2 screws M 3.5 for BS boxes  
 Supplied complete with plate  
 Dim.: 86 x 86 mm

Pack	Cat.Nos	Single pole switches 20 AX - 250 V~
10	2 810 50	<b>1 gang - 1-way switch</b> ○ White
10	2 810 51	<b>1 gang - 2-way switch</b> ○ White
4	2 810 69	<b>1 gang - intermediate switch</b> ○ White
10	2 810 52	<b>2 gang - 1-way switch</b> ○ White
10	2 810 53	<b>2 gang - 2-way switch</b> ○ White
10	2 810 54	<b>3 gang - 1-way switch</b> Compatible with metal boxes only, for installation fold the vertical lugs of the boxes ○ White
10	2 810 55	<b>3 gang - 2-way switch</b> Compatible with metal boxes only, for installation fold the vertical lugs of the boxes ○ White

Pack	Cat.Nos	Double pole switches 20 AX - 250 V~
10	2 810 60	Equipped with earth link connector <b>1 gang - 1-way</b> ○ White
10	2 810 61	<b>1 gang - 1-way with LED power indicator</b> ○ White
10	2 810 62	<b>1 gang - 1-way with LED power indicator and "WATER HEATER" marking</b> ○ White

Pack	Cat.Nos	Double pole switches 20 AX - 250 V~
10	2 810 65	Equipped with earth link connector <b>2 gang - 1-way with LED power indicator</b> ○ White
10	2 810 66	<b>1 gang - 1-way with LED power indicator and cable outlet</b> ○ White
10	2 810 67	<b>1 gang - 1-way with LED power indicator and cable outlet, "WATER HEATER" marking</b> ○ White
10	2 810 68	<b>1 gang - 2-way with "WATER HEATER" marking</b> ○ White

Pack	Cat.Nos	Double pole switches 45 A - 250 V~
10	2 810 71	Conform to BS EN 60669 - 1 <b>1 gang - 1-way with red indicator</b> ○ White
10	2 810 72	<b>1 gang - 1-way with red indicator and cooker marking</b> ○ White
5	2 810 73	<b>2 gang - 1-way vertical switch with red indicator</b> Dim.: 86 x 146 mm ○ White



2 810 40



2 810 84



2 810 91



2 810 75

Conform to BS EN 60669 – 1  
 Polycarbonate front cover plates with a matt finish  
 Compact mechanism for a larger wiring space  
 Supplied with 2 screws M 3.5 for BS boxes  
 Supplied complete with plate  
 Dim.: 86 x 86 mm

**Push-buttons 10 A - 250 V~**

Pack	Cat.Nos	Description
10	2 810 41	<b>N/O contact (push to make)</b> ○ White
10	2 810 40	<b>N/O contact with bell symbol</b> ○ White

**Leading edge dimmers**

1	2 810 80	<b>Rotary control dimmer</b> 60-500 W for incandescent and halogen lamps 230 V~ 60-500 VA ELV halogen lamps with ferromagnetic transformer and compensator Cat.No 0 401 39 ○ White
1	2 810 84	<b>Rotary control dimmer + switch</b> 60-500 W for incandescent and halogen lamps 230 V~ 60-200 VA ELV halogen lamps with ferromagnetic transformer and compensator Cat.No 0 401 39 ○ White
1	2 810 85	<b>Rotary dimmer</b> 60-1000 W (230 V) 60-500 W (127 V) for incandescent and halogen lamps 60-600 VA (230 V) 60-300 VA (127 V) for halogen lamps with electronic transformer with leading edge behaviour 60-1000 VA (230 V) 60-500 W (127 V) for halogen lamps with ferromagnetic transformers ○ White

**Automatic switch**

1	2 810 90	IR movement detector Horizontal detection angle 180° Luminosity threshold: 43 to 1614 lux Temporization: 20 s - 15 min Detection range: max. 12 m Compatible load: 25 - 200 W for incandescent and halogen lamps 230 V~ ○ White
---	----------	---

**Programmable switch**

1	2 810 92	Power supply: 230 VA - 50/60 Hz Maximum load: 2300 W Weekly programme Capacity: max. 28 programmes Output: 1 changeover contact ○ White
---	----------	--

**Time delay switch**

1	2 810 91	Adjustable time from 5 min to 12 h Maximum load: 500 W incandescent and halogen lamps 230 V~ 250 W fluorescent lamps without capacitor ○ White
---	----------	--

**Fan speed controls**

1	2 810 81	<b>400 VA rotary fan control</b> ○ White
1	2 810 82	<b>5-speed fan control</b> 100 W for fan with overall diameter 48" ○ White

**Cooker control unit 45 A - 250 V~**

5	2 810 75	Conform to BS 4177 45 A DP switch + 13 A switched socket outlet with red indicator Dim.: 146 x 86 mm ○ White
---	----------	---

















# Mallia™

telephone, data, television, shaver socket and cable outlets - complete white



Conform to BS EN 60669 – 1  
 Polycarbonate front cover plates with a matt finish. Compact mechanism for a larger wiring space  
 Supplied with 2 screws M 3.5 for BS boxes. Supplied complete with plate. Dim.: 86 x 86 mm

Pack	Cat.Nos	Telephone sockets	Pack	Cat.Nos	Television sockets	
5	2 811 60	<b>RJ 11 sockets - 4 contacts</b> 1/4 turn, tool-less connector ○ White 			For Hertzian and satellite installation (with individual demodulator) DTT and HDTV compatible-shielded sockets TV: male connector (Ø9.5 mm) R: female connector (Ø9.5 mm) SAT: "F" type connector Recommended coaxial cable: 17/19 VATC <b>TV-R-SAT socket</b> TV: 5-68/120 - 862 MHz R: 87.5-108 MHz SAT: 550-2400 MHz Star 1.5 dB	
5	2 811 63	<b>Double RJ 11 sockets - 4 contacts</b> 1/4 turn, tool-less connector ○ White 				
5	2 811 68	<b>BS master telephone sockets</b> ○ White 	5	2 811 57		
5	2 811 69	<b>BS secondary telephone sockets</b> ○ White 				<b>TV-R socket</b> TV: 5-68/120 - 862 MHz R: 87.5-108 MHz Star 1.5 dB ○ White
10	2 811 70	<b>2 A - 3 pin sockets</b> ○ White 	5	2 811 53		
			10	2 811 51		<b>TV socket</b> TV: 0-2400 MHz Star 1.5 dB ○ White
5	2 811 61	<b>Data sockets</b> <b>RJ 45 Cat. 5e UTP</b> ○ White 			<b>TV socket "F" type with screws</b> SAT: 0-2400 MHz Star 1.5 dB	
5	2 811 62	<b>RJ 45 Cat. 6 UTP</b> ○ White 	10	2 811 52		
5	2 811 64	<b>Double RJ 45 Cat. 5e UTP</b> ○ White 			<b>Shaver socket</b> 230 V / 120 V~ - 50/60 Hz. Dim.: 86 x 146 mm ○ White	
5	2 811 65	<b>Double RJ 45 Cat. 6 UTP</b> ○ White 	1	2 811 35		
5	2 811 66	<b>Telephone and data sockets</b> <b>RJ 11 + RJ 45 sockets Cat. 5e UTP</b> ○ White 			<b>Cable outlets</b> Conform to BS 5733	
			10	2 811 47	<b>20 A</b> ○ White 	
			5	2 811 48	<b>45 A</b> ○ White 	



Conform to BS EN 60669 – 1  
 Polycarbonate front cover plates with a matt finish  
 Compact mechanism for a larger wiring space  
 Supplied with 2 screws M 3.5 for BS boxes  
 All sockets integrate child protection  
 Supplied complete with plate  
 Dim.: 86 x 86 mm

Pack	Cat.Nos	British standard socket outlets 13 A - 250 V~
10	2 811 10	Conform to BS 1363: Part 2 <b>1 gang unswitched</b> ○ White
5	2 811 12	<b>2 gang unswitched</b> ○ White Dim.: 146 x 86 mm
10	2 811 11	<b>1 gang - single pole switched</b> ○ White
10	2 811 14	<b>1 gang - single pole switched with red power indicator</b> ○ White
5	2 811 13	<b>2 gang - single pole switched</b> ○ White Dim.: 146 x 86 mm
5	2 811 15	<b>2 gang - single pole switched with red power indicator</b> ○ White Dim.: 146 x 86 mm
10	2 811 16	<b>1 gang - double pole switched</b> ○ White
10	2 811 18	<b>1 gang - double pole switched with red power indicator</b> ○ White
5	2 811 17	<b>2 gang - double pole switched</b> ○ White Dim.: 146 x 86 mm
5	2 811 19	<b>2 gang - double pole switched with red power indicator</b> ○ White Dim.: 146 x 86 mm

Pack	Cat.Nos	British standard socket outlets 15 A - 250 V~
10	2 811 27	Conform to BS 546 <b>1 gang unswitched</b> ○ White
10	2 811 28	<b>1 gang switched</b> ○ White
10	2 811 29	<b>1 gang switched, with red LED power indicator</b> ○ White

Pack	Cat.Nos	British standard socket outlets 5 A - 250 V~
10	2 811 31	Conform to BS 546 <b>1 gang unswitched</b> ○ White
10	2 811 32	<b>1 gang switched</b> ○ White

Pack	Cat.Nos	13 A fused connection units
10	2 811 40	Conform to BS 1363: Part 4 <b>Unswitched</b> ○ White
10	2 811 41	<b>Switched</b> ○ White
10	2 811 42	<b>Switched with red LED power indicator</b> ○ White

# Mallia™

## Euro-US and German standard socket outlets - complete white



Polycarbonate front cover plates with a matt finish  
 Compact mechanism for a larger wiring space  
 Supplied with 2 screws M 3.5 for BS boxes  
 All sockets integrate child protection  
 Supplied complete with plate  
 Dim.: 86 x 86 mm

### Pack Cat.Nos Euro-US standard socket outlets 10/16 A - 250 V~

Pack	Cat.Nos	Socket Outlet Type	Color
10	2 811 00	2P - 1 gang	White
10	2 811 01	2P - 1 gang + 10 A switch	White
10	2 811 02	2P - 2 gang (separated connection)	White
10	2 811 03	2P+E - 1 gang	White
10	2 811 04	2P+E - 2 gang	White

### German standard socket outlet 16 A - 250 V~

Pack	Cat.Nos	Socket Outlet Type	Color
10	2 811 26	2P+E - 1 gang	White

### Multistandard socket outlet 16 A - 250 V / 15 A - 127 V

Pack	Cat.Nos	Socket Outlet Type	Color
10	2 811 20	2P+E - 1 gang	White

### US standard socket outlets 15 A - 127 V

Pack	Cat.Nos	Socket Outlet Type	Color
10	2 811 05	2P+E - 1 gang	White
10	2 811 06	2P+E - 2 gang	White

# Mallia™

## modular sockets - white



Polycarbonate front cover plates with a matt finish  
 Compact mechanism for a larger wiring space  
 Supplied with 2 screws M 3.5 for BS boxes  
 All sockets integrate child protection  
 Dim.: 146 x 86 mm

### Pack Cat.Nos Socket outlets modular mechanisms

Pack	Cat.Nos	Socket Outlet Type	Color
To be equipped with 2-gang support frame and plates (p. 515)			
5	2 818 55	1 gang unswitched - British standard - 13 A - 250 V~	White
5	2 818 58	1 gang switched - British standard - 13 A - 250 V~	White
8	2 818 47	2P+E - 1 gang - Euro - US standard - 10/16 A - 250 V~	White

# Mallia™

switches for hotels, downlighter and sound distribution - complete white



2 810 48



2 810 97













2 811 82

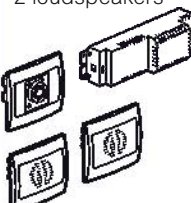

2 811 84

Polycarbonate front cover plates with a matt finish  
 Compact mechanism for a larger wiring space  
 Supplied with 2 screws M 3.5 for BS boxes  
 Supplied complete with plate  
 Dim.: 86 x 86 mm

Pack	Cat.Nos	Switches for hotels - 230 V~
1	2 810 48	<b>Key card switch - 15 A</b> Time delay around 30 s ○ White 
10	2 810 45	<b>Do not disturb / Occupied / Clean up Bell push-button</b> ○ White 
10	2 810 46	<b>Do not disturb / Clean up - 2 gang switch</b> ○ White 
5	2 810 97	<b>Downlighter</b> Low output downlighter 230 V~ , with LED <b>2P+E - 1 gang</b> ○ White 

Pack	Cat.Nos	Stand-alone sound distribution system for 1 single room
1	2 811 80	Kit containing: - 1 power supply - 1 tuner - 2 loudspeakers ○ White 
1	2 811 81	<b>Modular power supply</b> 230 V / 15 V - 15 W 5 DIN modules 17.5 mm 
1	2 811 82	<b>Central unit</b> ○ White 
1	2 811 83	<b>Local control unit</b> With LCD display, child surveillance and intercommunication ○ White 
1	2 811 84	<b>Radio tuner with local control unit</b> Dim.: 146 x 86 mm ○ White 
1	2 811 85	<b>Loudspeaker</b> ○ White 

# Mallia™

## single pole switches - customisable colours



2 830 02



2 832 04



2 830 12 + 2 819 98



2 834 16 + 2 819 97



Plate selection charts p. 515

Conform to BS EN 60669 – 1  
 Painted polycarbonate front cover  
 Compact mechanism for a larger wiring space  
 Supplied with 2 screws M 3.5 for BS boxes  
 To be equipped with plates  
 Dim.: 86 x 86 mm

Pack	Cat.Nos	Single pole standard switches 10 AX - 250 V~
5	2 830 00	<b>1 gang - 1-way switch</b> Silver Pearl Dark Silver
5	2 832 00	
5	2 834 00	
5	2 830 01	<b>1 gang - 2-way switch</b> Silver Pearl Dark Silver
5	2 832 01	
5	2 834 01	
4	2 830 08	<b>1 gang - intermediate switch</b> Silver Pearl Dark Silver
4	2 832 08	
4	2 834 08	
5	2 830 02	<b>2 gang - 1-way switch</b> Silver Pearl Dark Silver
5	2 832 02	
5	2 834 02	
5	2 830 03	<b>2 gang - 2-way switch</b> Silver Pearl Dark Silver
5	2 832 03	
5	2 834 03	
5	2 830 04	<b>3 gang - 1-way switch</b> Silver Pearl Dark Silver
5	2 832 04	
5	2 834 04	
5	2 830 05	<b>3 gang - 2-way switch</b> Silver Pearl Dark Silver
5	2 832 05	
5	2 834 05	
5	2 830 06	<b>4 gang - 1-way switch</b> Compatible with metal boxes only, for installation fold the vertical lugs of the boxes Silver Pearl Dark Silver
5	2 832 06	
5	2 834 06	
5	2 830 07	<b>4 gang - 2-way switch</b> Compatible with metal boxes only, for installation fold the vertical lugs of the boxes Silver Pearl Dark Silver
5	2 832 07	
5	2 834 07	

Pack	Cat.Nos	Single pole illuminated switches 10 AX - 250 V~
Transparent phosphorescent lens To be equipped with green or red LED according to the needs: indicator or locator (p. 514) The LED is not supplied		
5	2 830 10	<b>1 gang - 1-way switch</b> Silver Pearl Dark Silver
5	2 832 10	
5	2 834 10	
5	2 830 11	<b>1 gang - 2-way switch</b> Silver Pearl Dark Silver
5	2 832 11	
5	2 834 11	
4	2 830 09	<b>1 gang - intermediate switch</b> Silver Pearl Dark Silver
4	2 832 09	
4	2 834 09	
5	2 830 12	<b>2 gang - 1-way switch</b> Silver Pearl Dark Silver
5	2 832 12	
5	2 834 12	
5	2 830 13	<b>2 gang - 2-way switch</b> Silver Pearl Dark Silver
5	2 832 13	
5	2 834 13	
5	2 830 14	<b>3 gang - 1-way switch</b> Silver Pearl Dark Silver
5	2 832 14	
5	2 834 14	
5	2 830 15	<b>3 gang - 2-way switch</b> Silver Pearl Dark Silver
5	2 832 15	
5	2 834 15	
5	2 830 16	<b>4 gang - 1-way switch</b> Compatible with metal boxes only, for installation fold the vertical lugs of the boxes Silver Pearl Dark Silver
5	2 832 16	
5	2 834 16	
5	2 830 17	<b>4 gang - 2-way switch</b> Compatible with metal boxes only, for installation fold the vertical lugs of the boxes Silver Pearl Dark Silver
5	2 832 17	
5	2 834 17	



2 834 53



2 830 54



2 832 62



2 834 66

 Plate selection charts **p. 515**

Conform to BS EN 60669 – 1  
 Painted polycarbonate front cover  
 Compact mechanism for a larger wiring space  
 Supplied with 2 screws M 3.5 for BS boxes  
 To be equipped with plates  
 Dim.: 86 x 86 mm

Pack	Cat.Nos	Single pole switches 20 AX - 250 V $\sim$
5	2 830 50	<b>1 gang - 1-way switch</b> <ul style="list-style-type: none"> <li>● Silver</li> <li>● Pearl</li> <li>● Dark Silver</li> </ul>
5	2 832 50	
5	2 834 50	
5	2 830 51	<b>1 gang - 2-way switch</b> <ul style="list-style-type: none"> <li>● Silver</li> <li>● Pearl</li> <li>● Dark Silver</li> </ul>
5	2 832 51	
5	2 834 51	
4	2 830 69	<b>1 gang - intermediate switch</b> <ul style="list-style-type: none"> <li>● Silver</li> <li>● Pearl</li> <li>● Dark Silver</li> </ul>
4	2 832 69	
4	2 834 69	
5	2 830 52	<b>2 gang - 1-way switch</b> <ul style="list-style-type: none"> <li>● Silver</li> <li>● Pearl</li> <li>● Dark Silver</li> </ul>
5	2 832 52	
5	2 834 52	
5	2 830 53	<b>2 gang - 2-way switch</b> <ul style="list-style-type: none"> <li>● Silver</li> <li>● Pearl</li> <li>● Dark Silver</li> </ul>
5	2 832 53	
5	2 834 53	
5	2 830 54	<b>3 gang - 1-way switch</b> Compatible with metal boxes only, for installation fold the vertical lugs of the boxes <ul style="list-style-type: none"> <li>● Silver</li> <li>● Pearl</li> <li>● Dark Silver</li> </ul>
5	2 832 54	
5	2 834 54	
5	2 830 55	<b>3 gang - 2-way switch</b> Compatible with metal boxes only, for installation fold the vertical lugs of the boxes <ul style="list-style-type: none"> <li>● Silver</li> <li>● Pearl</li> <li>● Dark Silver</li> </ul>
5	2 832 55	
5	2 834 55	

Pack	Cat.Nos	Double pole switches 20 AX - 250 V $\sim$
5	2 830 60	<b>1 gang - 1-way</b> Equipped with earth link connector <ul style="list-style-type: none"> <li>● Silver</li> <li>● Pearl</li> <li>● Dark Silver</li> </ul>
5	2 832 60	
5	2 834 60	
5	2 830 61	<b>1 gang - 1-way with LED power indicator</b> <ul style="list-style-type: none"> <li>● Silver</li> <li>● Pearl</li> <li>● Dark Silver</li> </ul>
5	2 832 61	
5	2 834 61	
5	2 830 62	<b>1 gang - 1-way with LED power indicator and "WATER HEATER" marking</b> <ul style="list-style-type: none"> <li>● Silver</li> <li>● Pearl</li> <li>● Dark Silver</li> </ul>
5	2 832 62	
5	2 834 62	

Pack	Cat.Nos	Double pole switches 20 AX - 250 V $\sim$ (continued)
5	2 830 65	<b>2 gang - 1-way with LED power indicator</b> <ul style="list-style-type: none"> <li>● Silver</li> <li>● Pearl</li> <li>● Dark Silver</li> </ul>
5	2 832 65	
5	2 834 65	
5	2 830 66	<b>1 gang - 1-way with LED power indicator and cable outlet</b> <ul style="list-style-type: none"> <li>● Silver</li> <li>● Pearl</li> <li>● Dark Silver</li> </ul>
5	2 832 66	
5	2 834 66	
5	2 830 67	<b>1 gang - 1-way with LED power indicator and cable outlet, "WATER HEATER" marking</b> <ul style="list-style-type: none"> <li>● Silver</li> <li>● Pearl</li> <li>● Dark Silver</li> </ul>
5	2 832 67	
5	2 834 67	
5	2 830 68	<b>1 gang - 2-way with "WATER HEATER" marking</b> <ul style="list-style-type: none"> <li>● Silver</li> <li>● Pearl</li> <li>● Dark Silver</li> </ul>
5	2 832 68	
5	2 834 68	

Pack	Cat.Nos	Double pole switches 45 A - 250 V $\sim$
5	2 830 71	<b>1 gang - 1-way with red indicator</b> <ul style="list-style-type: none"> <li>● Silver</li> <li>● Pearl</li> <li>● Dark Silver</li> </ul>
5	2 832 71	
5	2 834 71	
5	2 830 72	<b>1 gang - 1-way with red indicator and cooker marking</b> <ul style="list-style-type: none"> <li>● Silver</li> <li>● Pearl</li> <li>● Dark Silver</li> </ul>
5	2 832 72	
5	2 834 72	
5	2 830 73	<b>2 gang - 1-way vertical switch with red indicator</b> Dim.: 86 x 146 mm Use special plates (p. 514) <ul style="list-style-type: none"> <li>● Silver</li> <li>● Pearl</li> <li>● Dark Silver</li> </ul>
5	2 832 73	
5	2 834 73	

# Mallia™

push-buttons, dimmers, automatic switches and other lighting functions - customisable colours



2 830 84



2 834 90



2 832 81



2 812 75

Plate selection charts p. 515

Conform to BS EN 60669 – 1  
Painted polycarbonate front cover  
Compact mechanism for a larger wiring space  
Supplied with 2 screws M 3.5 for BS boxes  
To be equipped with plates - Dim.: 86 x 86 mm

## Pack Cat.Nos Push-buttons 10 A - 250 V~

Pack	Cat.Nos	Color
5	2 830 41	Silver
5	2 832 41	Pearl
5	2 834 41	Dark Silver
5	2 830 40	Silver
5	2 832 40	Pearl
5	2 834 40	Dark Silver

### N/O contact (push to make)

- Silver
- Pearl
- Dark Silver

### N/O contact with bell symbol

- Silver
- Pearl
- Dark Silver

## Leading edge dimmers

### Rotary control dimmer

60-500 W for incandescent and halogen lamps  
230 V~  
60-500 VA ELV halogen lamps with ferromagnetic transformer and compensator  
Cat.No 0 401 39

1	2 830 80	Silver
1	2 832 80	Pearl
1	2 834 80	Dark Silver

### Rotary control dimmer + switch

60-500 W for incandescent and halogen lamps  
230 V~  
60-200 VA ELV halogen lamps with ferromagnetic transformer and compensator  
Cat.No 0 401 39

1	2 830 84	Silver
1	2 832 84	Pearl
1	2 834 84	Dark Silver

### Rotary dimmer

60-1000 W (230 V) - 60-500 W (127 V) for incandescent and halogen lamps  
60-600 VA (230 V) 60-300 VA (127 V) for halogen lamps with electronic transformer with leading edge behaviour  
60-1000 VA (230 V) 60-500 W (127 V) for halogen lamps with ferromagnetic transformers

1	2 830 85	Silver
1	2 832 85	Pearl
1	2 834 85	Dark Silver

## Automatic switches

IR movement detector  
Horizontal detection angle 180°  
Luminosity threshold: 43 to 1614 lux  
Temporization: 20 s - 15 min  
Detection range: max. 12 m  
Compatible load: 25 - 200 W for incandescent and halogen lamps 230 V~

1	2 830 90	Silver
1	2 832 90	Pearl
1	2 834 90	Dark Silver

## Pack Cat.Nos Programmable switches

Pack	Cat.Nos	Color
1	2 830 92	Silver
1	2 832 92	Pearl
1	2 834 92	Dark Silver

Power supply: 230 V~ - 50/60 Hz  
Maximum load: 2300 W  
Weekly programme  
Capacity: max. 28 programmes  
Output: 1 changeover contact

- Silver
- Pearl
- Dark Silver

## Time delay switches

Adjustable time from 5 min to 12 h  
Maximum load:  
500 W incandescent and halogen lamps 230 V~  
250 W fluorescent lamps without capacitor

1	2 830 91	Silver
1	2 832 91	Pearl
1	2 834 91	Dark Silver

- Silver
- Pearl
- Dark Silver

## Fan speed controls

### 400 VA rotary fan controls

1	2 830 81	Silver
1	2 832 81	Pearl
1	2 834 81	Dark Silver

- Silver
- Pearl
- Dark Silver

### 5-speed fan controls

100 W for fan with overall diameter 48"

1	2 830 82	Silver
1	2 832 82	Pearl
1	2 834 82	Dark Silver

- Silver
- Pearl
- Dark Silver

## Cooker control units 45 A - 250 V~

Supplied complete with plate  
Conform to BS 4177  
45 A DP switch + 13 A switched socket outlet with red indicator  
Dim.: 146 x 86 mm

5	2 812 75	Silver
5	2 832 75	Pearl
5	2 834 75	Dark Silver

- Silver
- Pearl
- Dark Silver



2 835 63



2 831 62



2 835 51



2 831 35

 Plate selection charts **p. 515**

Conform to BS EN 60669 – 1

Painted polycarbonate front cover. Compact mechanism for a larger wiring space

Supplied with 2 screws M 3.5 for BS boxes. To be equipped with plates - Dim.: 86 x 86 mm

Pack	Cat.Nos	Telephone sockets	Pack	Cat.Nos	Television sockets
5	2 831 60	<b>RJ 11 sockets - 4 contacts</b> 1/4 turn, tool-less connector	5	2 831 57	<b>TV-R-SAT sockets - star 1.5 dB</b> TV: 5-68/120-862 MHz
5	2 833 60	Silver	5	2 833 57	R: 87.5-108 MHz
5	2 835 60	Pearl	5	2 835 57	SAT: 550-2400 MHz
		Dark Silver			
5	2 831 63	<b>Double RJ 11 sockets - 4 contacts</b> 1/4 turn, tool-less connector	5	2 831 53	<b>TV-R sockets- star 1.5 dB</b> TV: 5-68/120-862 MHz
5	2 833 63	Silver	5	2 833 53	R: 87.5-108 MHz
5	2 835 63	Pearl	5	2 835 53	Silver
		Dark Silver			Pearl
5	2 831 68	<b>BS master telephone sockets</b>	5	2 831 51	<b>TV sockets - star 1.5 dB</b> TV: 0-2400 MHz
5	2 833 68	Silver	5	2 833 51	Silver
5	2 835 68	Pearl	5	2 835 51	Pearl
		Dark Silver			Dark Silver
5	2 831 69	<b>BS secondary telephone sockets</b>	5	2 831 52	<b>TV sockets "F" type with screws-star 1.5 dB</b> SAT: 0-2400 MHz
5	2 833 69	Silver	5	2 833 52	Silver
5	2 835 69	Pearl	5	2 835 52	Pearl
		Dark Silver			Dark Silver
5	2 831 70	<b>2 A - 3 pin sockets</b>			
5	2 833 70	Silver			
5	2 835 70	Pearl			
		Dark Silver			
		<b>Data sockets</b>			
5	2 831 61	<b>RJ 45 Cat. 5e UTP</b>			<b>Shaver sockets</b> 230 V / 120 V~ - 50/60 Hz
5	2 833 61	Silver			Dim.: 86 x 146 mm
5	2 835 61	Pearl	1	2 831 35	Silver
		Dark Silver	1	2 833 35	Pearl
5	2 831 62	<b>RJ 45 Cat. 6 UTP</b>	1	2 835 35	Dark Silver
5	2 833 62	Silver			
5	2 835 62	Pearl			
		Dark Silver			
5	2 831 64	<b>Double RJ 45 Cat. 5e UTP</b>			
5	2 833 64	Silver			
5	2 835 64	Pearl			
		Dark Silver			
5	2 831 65	<b>Double RJ 45 Cat. 6 UTP</b>			
5	2 833 65	Silver			
5	2 835 65	Pearl			
		Dark Silver			
		<b>Telephone and data sockets</b>			
5	2 831 66	<b>RJ 11 + RJ 45 sockets Cat. 5e UTP</b>			<b>Cable outlets</b> Conform to BS 5733
5	2 833 66	Silver	5	2 831 47	<b>20 A</b>
5	2 835 66	Pearl	5	2 833 47	Silver
		Dark Silver	5	2 835 47	Pearl
					Dark Silver
			5	2 831 48	<b>45 A - supplied complete with plate</b>
			5	2 833 48	Silver
			5	2 835 48	Pearl
					Dark Silver



# Mallia™

## British standard socket outlets and fused connection units - customisable colours



2 833 13



2 817 18



2 835 28



2 833 42

Plate selection charts p. 515

Conform to BS EN 60669 – 1. Painted polycarbonate front cover  
Compact mechanism for a larger wiring space. Supplied with 2 screws  
M 3.5 for BS boxes. All sockets integrate child protection  
To be equipped with plates. Dim.: 86 x 86 mm

Pack	Cat.Nos	British standard socket outlets 13 A - 250 V~
		Conform to BS 1363: Part 2
		<b>1 gang unswitched</b>
5	2 831 10	Silver
5	2 833 10	Pearl
5	2 835 10	Dark Silver
		<b>2 gang unswitched - Dim.: 146 x 86 mm</b>
5	2 831 12	Silver
5	2 833 12	Pearl
5	2 835 12	Dark Silver
		<b>1 gang - single pole switched</b>
5	2 831 11	Silver
5	2 833 11	Pearl
5	2 835 11	Dark Silver
		<b>1 gang - single pole switched with red power indicator</b>
5	2 831 14	Silver
5	2 833 14	Pearl
5	2 835 14	Dark Silver
		<b>2 gang - single pole switched - Dim.: 146 x 86 mm</b>
5	2 831 13	Silver
5	2 833 13	Pearl
5	2 835 13	Dark Silver
		<b>2 gang - single pole switched with red power indicator - Dim.: 146 x 86 mm</b>
5	2 831 15	Silver
5	2 833 15	Pearl
5	2 835 15	Dark Silver

Pack	Cat.Nos	British standard double pole socket outlets 13 A - 250 V~
		Supplied complete with plate
		<b>1 gang - double pole switched</b>
5	2 813 16	Silver
5	2 816 16	Pearl
5	2 817 16	Dark Silver
		<b>1 gang - double pole switched with red power indicator</b>
5	2 813 18	Silver
5	2 816 18	Pearl
5	2 817 18	Dark Silver
		<b>2 gang - double pole switched - Dim.: 146 x 86 mm</b>
5	2 813 17	Silver
5	2 816 17	Pearl
5	2 817 17	Dark Silver
		<b>2 gang - double pole switched with red power indicator - Dim.: 146 x 86 mm</b>
5	2 813 19	Silver
5	2 816 19	Pearl
5	2 817 19	Dark Silver

Pack	Cat.Nos	British standard socket outlets 15 A - 250 V~
		Conform to BS 546
		<b>1 gang unswitched</b>
5	2 831 27	Silver
5	2 833 27	Pearl
5	2 835 27	Dark Silver
		<b>1 gang switched</b>
5	2 831 28	Silver
5	2 833 28	Pearl
5	2 835 28	Dark Silver
		<b>1 gang switched, with red LED power indicator</b>
5	2 831 29	Silver
5	2 833 29	Pearl
5	2 835 29	Dark Silver

Pack	Cat.Nos	British standard socket outlets 5 A - 250 V~
		Conform to BS 546
		<b>1 gang unswitched</b>
5	2 831 31	Silver
5	2 833 31	Pearl
5	2 835 31	Dark Silver
		<b>1 gang switched</b>
5	2 831 32	Silver
5	2 833 32	Pearl
5	2 835 32	Dark Silver

Pack	Cat.Nos	13 A fused connection units
		Conform to BS 1363: Part 4
		<b>Unswitched</b>
5	2 831 40	Silver
5	2 833 40	Pearl
5	2 835 40	Dark Silver
		<b>Switched</b>
5	2 831 41	Silver
5	2 833 41	Pearl
5	2 835 41	Dark Silver
		<b>Switched with red LED power indicator</b>
5	2 831 42	Silver
5	2 833 42	Pearl
5	2 835 42	Dark Silver

## Mallia™ – Euro-US and German standard socket outlets

customisable colours



2 835 02

2 831 26

Plate selection charts p. 515

Painted polycarbonate front cover. Compact mechanism for a larger wiring space. Supplied with 2 screws M 3.5 for BS boxes  
All sockets integrate child protection. To be equipped with plates  
Dim.: 86 x 86 mm

### Pack Cat.Nos Euro-US standard socket outlets 10/16 A - 250 V~

Pack	Cat.Nos	Socket Type	Colours
5	2 831 00	2P - 1 gang	● Silver
5	2 833 00		● Pearl
5	2 835 00		● Dark Silver
5	2 831 01	2P - 1 gang + 10 A switch	● Silver
5	2 833 01		● Pearl
5	2 835 01		● Dark Silver
5	2 831 02	2P - 2 gang (separated connection)	● Silver
5	2 833 02		● Pearl
5	2 835 02		● Dark Silver
5	2 831 03	2P+E - 1 gang	● Silver
5	2 833 03		● Pearl
5	2 835 03		● Dark Silver
5	2 831 04	2P+E - 2 gang	● Silver
5	2 833 04		● Pearl
5	2 835 04		● Dark Silver

### German standard socket outlets 16 A - 250 V~

Pack	Cat.Nos	Socket Type	Colours
5	2 831 26	2P+E - 1 gang	● Silver
5	2 833 26		● Pearl
5	2 835 26		● Dark Silver

### Multistandard socket outlets - 16 A - 250 V / 15 A - 127 V

Pack	Cat.Nos	Socket Type	Colours
5	2 831 20	2P+E - 1 gang	● Silver
5	2 833 20		● Pearl
5	2 835 20		● Dark Silver

### US standard socket outlets 15 A - 127 V - SASO

Pack	Cat.Nos	Socket Type	Colours
5	2 831 05	2P+E - 1 gang	● Silver
5	2 833 05		● Pearl
5	2 835 05		● Dark Silver
5	2 831 06	2P+E - 2 gang	● Silver
5	2 833 06		● Pearl
5	2 835 06		● Dark Silver

## Mallia™

modular socket outlets customisable colours



2 818 56

2 818 59

2 819 31

Plate selection charts p. 515

Painted polycarbonate front cover

### Pack Cat.Nos Modular socket outlets

Compact mechanism for a larger wiring space  
Supplied with 2 screws M 3.5 for BS boxes  
All sockets integrate child protection  
To be equipped with 2-gang support frames and plates  
Dim.: 146 x 86 mm

#### 1 gang unswitched - British standard - 13 A - 250 V~

Pack	Cat.Nos	Socket Type	Colours
5	2 818 56	1 gang unswitched	● Silver
5	2 818 75		● Pearl
5	2 818 76		● Dark Silver

#### 1 gang switched - British standard - 13 A - 250 V~

Pack	Cat.Nos	Socket Type	Colours
5	2 818 59	1 gang switched	● Silver
5	2 818 78		● Pearl
5	2 818 79		● Dark Silver

#### 2P+E - 1 gang - Euro - US standard - 10/16 A - 250 V~

Pack	Cat.Nos	Socket Type	Colours
8	2 818 48	2P+E - 1 gang	● Silver
8	2 818 67		● Pearl
8	2 818 68		● Dark Silver

### Support frames and plates - for modular socket outlets

#### 2 gang plastic

Supplied with fixing screws

Pack	Cat.Nos	Socket Type	Colours
5	2 819 30	2 gang plastic	○ White
5	2 819 31		● Silver
5	2 819 32		● Champagne
5	2 819 33		● Pearl
5	2 819 34		● Dark Silver
5	2 819 46		● Brass
5	2 819 47		● Bronze
5	2 819 48		● Matt Black
5	2 819 48		● Pearl
5	2 819 49		● Copper

#### 2 gang metal

Supplied with fixing screws

Pack	Cat.Nos	Socket Type	Colours
1	2 819 20	2 gang metal	● Brushed Stainless Steel
1	2 819 21		● Gold
1	2 819 22		● Polished Stainless Steel
1	2 819 23		● Lacquered Black

# Mallia™

switches for hotels, downlighters and sound distribution - customisable colours



2 830 45



2 834 97



2 833 80



2 831 85

Plate selection charts p. 515

Painted polycarbonate front cover  
Compact mechanism for a larger wiring space  
Supplied with 2 screws M 3.5 for BS boxes  
To be equipped with plates  
Dim.: 86 x 86 mm

Pack	Cat.Nos	Switches for hotels - 230 V~
		<b>Key card switches - 15 A</b> Time delay around 30 s
1	2 830 48	Silver
1	2 832 48	Pearl
1	2 834 48	Dark Silver
		<b>Do not disturb / Occupied / Clean up Bell push-buttons</b>
5	2 830 45	Silver
5	2 832 45	Pearl
5	2 834 45	Dark Silver
		<b>Do not disturb / Clean up - 2 gang switches</b>
5	2 830 46	Silver
5	2 832 46	Pearl
5	2 834 46	Dark Silver
		<b>Downlighters</b>
5	2 830 97	Silver
5	2 832 97	Pearl
5	2 834 97	Dark Silver

Pack	Cat.Nos	Stand-alone sound distribution system for 1 single room
		Kit containing: - 1 power supply - 1 tuner - 2 loudspeakers
1	2 831 80	Silver
1	2 833 80	Pearl
1	2 835 80	Dark Silver
		<b>Configurable sound distribution system for several rooms</b>
1	2 811 81	<b>Modular power supply</b> 230 V / 15 V - 15 W 5 DIN modules 17.5 mm 
1	2 831 82	<b>Central units</b> Silver
1	2 833 82	Pearl
1	2 835 82	Dark Silver
1	2 831 83	<b>Local control units</b> With LCD display, child surveillance and intercommunication Silver
1	2 833 83	Pearl
1	2 835 83	Dark Silver
1	2 831 84	<b>Radio tuner with local control units</b> Dim.: 146 x 86 mm Silver
1	2 833 84	Pearl
1	2 835 84	Dark Silver
1	2 831 85	<b>Loudspeakers</b> Silver
1	2 833 85	Pearl
1	2 835 85	Dark Silver



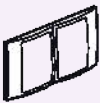























Plate selection charts p. 515

Pack	Cat.Nos	Plates
10	2 819 00	<b>1 gang - plastic</b> <ul style="list-style-type: none"> <li>○ White</li> <li>● Silver</li> <li>● Champagne</li> <li>● Pearl</li> <li>● Dark Silver</li> <li>● Brass</li> <li>● Bronze</li> <li>● Matt Black</li> <li>● Copper</li> </ul>
10	2 819 05	
10	2 819 10	
10	2 819 50	
10	2 819 55	
10	2 819 60	
10	2 819 65	
10	2 819 70	
10	2 819 75	
1	2 819 78	
1	2 819 82	
1	2 819 86	
1	2 819 90	
5	2 819 01	<b>2 x 1 gang - plastic</b> <ul style="list-style-type: none"> <li>○ White</li> <li>● Silver</li> <li>● Champagne</li> <li>● Pearl</li> <li>● Dark Silver</li> <li>● Brass</li> <li>● Bronze</li> <li>● Matt Black</li> <li>● Copper</li> </ul>
5	2 819 06	
5	2 819 11	
5	2 819 51	
5	2 819 56	
5	2 819 61	
5	2 819 66	
5	2 819 71	
5	2 819 76	
1	2 819 79	
1	2 819 83	
1	2 819 87	
1	2 819 91	
5	2 819 02	<b>2 gang - Vertical</b> For 2 gang vertical DP switch 45 A (p. 508) <ul style="list-style-type: none"> <li>○ White</li> <li>● Silver</li> <li>● Champagne</li> <li>● Pearl</li> <li>● Dark Silver</li> <li>● Brass</li> <li>● Bronze</li> <li>● Matt Black</li> <li>● Copper</li> <li>● Brushed Stainless Steel</li> <li>● Gold</li> <li>● Polished Stainless Steel</li> <li>● Lacquered Black</li> </ul>
5	2 819 07	
5	2 819 12	
5	2 819 52	
5	2 819 57	
5	2 819 62	
5	2 819 67	
5	2 819 72	
5	2 819 77	
1	2 819 80	
1	2 819 84	
1	2 819 88	
1	2 819 92	

Pack	Cat.Nos	Blanking plates
10	2 811 90	<b>1 gang</b> <ul style="list-style-type: none"> <li>○ White</li> <li>● Silver</li> <li>● Pearl</li> <li>● Dark Silver</li> </ul>
10	2 831 90	
10	2 833 90	
10	2 835 90	
5	2 811 91	<b>2 gang</b> <ul style="list-style-type: none"> <li>○ White</li> <li>● Silver</li> <li>● Pearl</li> <li>● Dark Silver</li> </ul>
5	2 831 91	
5	2 833 91	
5	2 835 91	
5	2 811 92	<b>Arteor adaptors</b> <b>1 gang</b> <ul style="list-style-type: none"> <li>○ White - Supplied with cover plate</li> <li>● Silver - Not supplied with cover plate</li> <li>● Pearl - Not supplied with cover plate</li> <li>● Dark Silver - Not supplied with cover plate</li> </ul>
5	2 831 92	
5	2 835 92	
5	2 811 93	<b>2 gang</b> <ul style="list-style-type: none"> <li>○ White - Supplied with cover plate</li> <li>● Silver - Not supplied with cover plate</li> <li>● Pearl - Not supplied with cover plate</li> <li>● Dark Silver - Not supplied with cover plate</li> </ul>
5	2 831 93	
5	2 833 93	
5	2 835 93	
5	2 818 95	<b>Transparent rockers with label holders for switches</b> Can be used instead of the standard rocker plates Supplied with white labels 1 gang
5	2 818 96	
5	2 818 97	
10	2 819 97	<b>Lamps</b> LED 220 V, green low consumption For locator use
10	2 819 98	
		LED 220 V, red - high luminosity For indicator use

# Mallia™

## plate selection charts - customisable

PLATES		 PLATES			 SUPPORT FRAMES AND PLATES FOR MODULAR SOCKET OUTLETS
	1 gang	2 x 1 gang	2 gang	2 gang	
White 	2 819 00	2 819 01	2 819 02	2 819 30	
Silver 	2 819 05	2 819 06	2 819 07	2 819 31	
Champagne 	2 819 10	2 819 11	2 819 12	2 819 32	
Pearl 	2 819 50	2 819 51	2 819 52	2 819 33	
Dark Silver 	2 819 55	2 819 56	2 819 57	2 819 34	
Brass 	2 819 60	2 819 61	2 819 62	2 819 46	
Bronze 	2 819 65	2 819 66	2 819 67	2 819 47	
Matt Black 	2 819 70	2 819 71	2 819 72	2 819 48	
Copper 	2 819 75	2 819 76	2 819 77	2 819 49	
Metal Brushed Stainless Steel 	2 819 78	2 819 79	2 819 80	2 819 20	
Metal Gold 	2 819 82	2 819 83	2 819 84	2 819 21	
Metal Polished Stainless Steel 	2 819 86	2 819 87	2 819 88	2 819 22	
Metal Lacquered Black 	2 819 90	2 819 91	2 819 92	2 819 23	
PLATES		 BLANKING PLATES			 ARTEOR ADAPTORS
	1 gang	2 x 1 gang	1 gang	2 gang	
White 	2 811 90	2 811 91	2 811 92	2 811 93	
Silver 	2 831 90	2 831 91	2 831 92	2 831 93	
Pearl 	2 833 90	2 833 91	2 833 92	2 833 93	
Dark Silver 	2 835 90	2 835 91	2 835 92	2 835 93	

GRID SYSTEM	FRONT PLATES FOR ARTEOR MECHANISMS					
	1 gang for 1 Arteor module	1 gang for 2 Arteor modules	2 gang for 3 Arteor modules	2 gang for 4 Arteor modules	2 x 2 gang for 8 Arteor modules	3 x 3 gang for 18 Arteor modules
<b>FRONT PLATES</b>	Clip-in carrier plate - No yoke required				Yoke required	
<b>Dimensions (mm)</b>	<b>86 x 86</b>	<b>86 x 86</b>	<b>86 x 146</b>	<b>86 x 146</b>	<b>146 x 146</b>	<b>267 x 207</b>
<b>White</b>	7 300 91	7 300 92	7 300 93	7 300 94	7 301 88	7 301 90
<b>Traditional Brushed stainless steel</b>	7 330 91	7 330 92	7 330 93	7 330 94	7 331 88	7 331 90
<b>Traditional Polished stainless steel</b>	7 332 91	7 332 92	7 332 93	7 332 94	-	-
<b>Traditional Satin brass</b>	7 334 91	7 334 92	7 334 93	7 334 94	-	-
<b>Flat plate Antique Brass</b>	7 342 91	7 342 92	7 342 93	7 342 94	-	-
<b>Flat plate Brushed Stainless Steel</b>	7 346 91	7 346 92	7 346 93	7 346 94	-	-
<b>Metalclad</b>	7 338 91 <sup>(1)</sup>	7 338 92 <sup>(1)</sup>	7 338 93 <sup>(1)</sup>	7 338 94 <sup>(1)</sup>	-	-
<b>Dimensions (mm)</b>	<b>89 x 89<sup>(2)</sup></b>	<b>89 x 89<sup>(2)</sup></b>	<b>89 x 149<sup>(2)</sup></b>	<b>89 x 149<sup>(2)</sup></b>	<b>146 x 146</b>	<b>267 x 207</b>
<b>Modern Silver</b>	7 310 91	7 310 92	7 310 93	7 310 94	-	-
<b>Modern Nickel</b>	7 312 91	7 312 92	7 312 93	7 312 94	-	-
<b>GRID YOKES</b>						
<b>Grid yokes</b>	No yoke required					
					2 x 7 354 74	2 x 7 354 76
<b>Arteor mechanisms</b> (p. 360)						

# Synergy™

## single pole switches, single pole push and key switches, rotary dimmers - white



Front plates: white thermoset  
Terminal screws captive and backed off ready for cabling - large angled terminal entries  
Compact mechanism for maximised wiring space  
Supplied with faceplate screw caps

Pack	Cat.Nos	Single pole plate switches 10 AX - 250 V~	Pack	Cat.Nos	Single pole key switch 10 AX - 250 V~
10	7 300 00	<p>Conform to BS EN 60669-1 For flush-mounting, back box to be min. 16 mm deep ASTA licence </p> <p><b>Nominal plate dimensions: 86 x 86 mm</b></p> <p>1 gang - 1 way 1 gang - 2 way 1 gang - intermediate</p> <p>2 gang - 1 way 2 gang - 2 way</p> <p>3 gang - 1 way 3 gang - 2 way</p> <p><b>Nominal plate dimensions: 86 x 146 mm</b></p> <p>4 gang - 2 way</p> <p>6 gang - 2 way</p>	10	7 300 08	<p>Conform to BS EN 60669-1: 2000 Key supplied For flush-mounting, back box to be min. 16 mm deep Nominal plate dimensions: 86 x 86 mm</p> <p>1 gang - 2 way</p>
10	7 300 01				
10	7 300 05				
10	7 300 24				
10	7 300 02				
10	7 301 24				
10	7 300 03				
5	7 300 04				
5	7 300 06				
10	7 301 30		<p>Conform to BS EN 60669-1 For flush-mounting, back box to be min. 16 mm deep Nominal plate dimensions: 86 x 86 mm</p> <p>1 gang - 1 way 1 gang - 2 way</p> <p>2 gang - 1 way 2 gang - 2 way</p> <p>3 gang - 1 way 3 gang - 2 way</p>	1	7 300 09
10	7 301 31				
10	7 301 34				
10	7 301 32				
10	7 301 35				
10	7 301 33				
1	7 301 56				<p><b>Push on/off rotary dimmers 400 W 100 - 240 V~ - 50/60 Hz</b></p> <p>Conform to BS EN 60669-1 For flush-mounting, back box to be min. 25 mm deep</p> <p><b>Nominal plate dimensions: 86 x 86 mm</b></p> <p>1 gang - 2 way</p>
1	7 301 57				<p>2 gang - 2 way</p>
1	7 300 49				<p><b>Nominal plate dimensions: 86 x 146 mm</b></p> <p>4 gang - 2 way</p>
5	7 300 07	<p><b>Single pole push switches 10 A - 250 V~</b></p> <p>Conform to BS EN 60669-1 For flush-mounting, back box to be min. 16 mm deep ASTA licence </p> <p>Nominal plate dimensions: 86 x 86 mm</p> <p>1 gang - 2 way push switch</p> <p>1 gang - 2 way push switch marked "PRESS"</p> <p>1 gang - 2 way push switch with bell symbol</p>		1	7 301 50
5	7 300 11				
5	7 301 07				

Surface mounting boxes, p. 521



## Synergy™

### double pole switches - white



7 301 10

7 300 22

Front plates: white thermoset  
Terminal screws captive and backed off ready for cabling - large angled terminal entries  
Compact mechanism for maximised wiring space  
Supplied with faceplate screw caps

Pack	Cat.Nos	Double pole switches 20 A - 250 V~
10	7 300 10	Conform to BS EN 60669-1 For flush-mounting, back box to be min. 25 mm deep Use cord outlet accessory box Cat.No 7 300 53 for external cord outlet ASTA licence Nominal plate dimensions: 86 x 86 mm DP switch
10	7 300 12	DP switch + red LED power indicator LED invisible until activated
10	7 301 10	DP switch marked "WATER HEATER"
10	7 301 12	DP switch marked "WATER HEATER" + red LED power indicator LED invisible until activated

Pack	Cat.Nos	Double pole switches 45 A - 250 V~
10	7 300 22	Conform to BS EN 60669-1 ASTA licence For flush-mounting, back box to be min. 45 mm deep <b>Nominal plate dimensions: 86 x 86 mm</b> DP switch
10	7 300 23	DP switch + red LED power indicator LED invisible until activated
10	7 301 22	DP switch red rocker marked "COOKER"
5	7 300 20	<b>Nominal plate dimensions: 146 x 86 mm</b> DP switch
5	7 300 21	DP switch + red LED power indicator LED invisible until activated
5	7 301 20	DP switch red rocker marked "COOKER"

## Synergy™

### telephone, data and TV sockets - white



7 300 50

7 300 57

7 300 43

Front plates: white thermoset  
Terminal screws captive and backed off ready for cabling - large angled terminal entries  
Compact mechanism for maximised wiring space  
Supplied with faceplate screw caps

Pack	Cat.Nos	Euro module front plates
10	7 300 99	Suitable for use with standard 25 x 50 mm Euro data module inserts 1 gang - 86 x 86 mm 2 modules - aperture size 50 x 50 mm
10	7 301 00	2 gang - 86 x 146 mm 4 modules - aperture size 50 x 100 mm
10	7 300 50	<b>Telephone sockets</b> For flush-mounting, back box to be min. 35 mm deep Nominal plate dimensions: 86 x 86 mm UK master
10	7 300 51	UK secondary
10	7 300 54	RJ 11/RJ 12 - single
1	7 300 56	<b>Data sockets - Cat. 6</b> Rapid cable connection For flush-mounting, back box to be min. 35 mm deep Nominal plate dimensions: 86 x 86 mm RJ 45 - single
1	7 300 57	RJ 45 - twin
10	7 300 40	<b>Television sockets</b> For flush-mounting, back box to be min. 35 mm deep <b>Nominal plate dimensions: 86 x 86 mm</b> Screened TV socket single - male
10	7 301 40	Screened TV socket single - female
10	7 301 44	Screened TV socket single pass trough - female
10	7 301 45	Screened TV socket single terminal - female
1	7 300 41	SAT socket single - "F" type
10	7 300 42	TV-R socket
1	7 300 43	TV-R-SAT socket "F" type



# Synergy™

## British standard socket outlets - white



Front plates: white thermoset  
 Terminal screws captive and backed off ready for cabling - large angled terminal entries  
 Compact mechanism for maximised wiring space  
 Supplied with faceplate screw caps

Pack	Cat.Nos	Socket outlets 13 A - 250 V~
10	7 300 65	Conform to BS 1363: Part. 2 For flush-mounting, back box to be min. 25 mm deep ASTA licence <b>Unswitched</b> 1 gang Nominal plate dimensions: 86 x 86 mm
5	7 300 75	2 gang Nominal plate dimensions: 86 x 146 mm
10	7 300 66	<b>Single pole - switched</b> Fitted with traditional earth pin release shutter and single earth terminal 1 gang Nominal plate dimensions: 86 x 86 mm
5	7 300 76	2 gang Nominal plate dimensions: 86 x 146 mm

Pack	Cat.Nos	Socket outlets 13 A - 250 V~ Special earth pin
10	7 300 67	For flush-mounting, back box to be min. 25 mm deep <b>Double pole - switched</b> 1 gang Nominal plate dimensions: 86 x 86 mm
5	7 300 77	2 gang Nominal plate dimensions: 86 x 146 mm

Pack	Cat.Nos	Double pole socket outlets 13 A - 250 V~
10	7 300 60	Conform to BS 1363: Part. 2 Patented 3 pin safety shutters mechanism 2 earth terminals For flush-mounting, back box to be min. 25 mm deep ASTA licence <b>Switched</b> 1 gang Nominal plate dimensions: 86 x 86 mm
5	7 300 70	2 gang Nominal plate dimensions: 86 x 146 mm
10	7 300 61	<b>Switched with red LED power indicator</b> LED invisible until activated 1 gang Nominal plate dimensions: 86 x 86 mm
5	7 300 71	2 gang Nominal plate dimensions: 86 x 146 mm
10	7 300 64	<b>Switched for standard and clean earth applications</b> 1 gang Nominal plate dimensions: 86 x 86 mm
5	7 300 74	2 gang Nominal plate dimensions: 86 x 146 mm
10	7 301 62	<b>Switched with red rocker</b> 1 gang Nominal plate dimensions: 86 x 86 mm
5	7 301 61	2 gang Nominal plate dimensions: 86 x 146 mm



## Synergy™

### British standard socket outlets - white (continued)



7 300 89



7 300 69

Front plates: white thermoset  
Terminal screws captive and backed off ready for cabling - large angled terminal entries  
Compact mechanism for maximised wiring space  
Supplied with faceplate screw caps

Pack	Cat.Nos	Socket outlets 15 A - 250 V~
10	7 300 88	Conform to BS 546 Patented 3 pin safety shutters mechanism For flush-mounting, back box to be min. 35 mm deep Nominal plate dimensions: 86 x 86 mm 1 gang - unswitched
10	7 300 89	1 gang - switched, single pole
5	7 300 85	<b>Sockets outlets 15 A - 127 V~</b> Standard terminal screws For flush-mounting, back box to be min. 35 mm deep 1 gang unswitched Nominal plate dimensions: 86 x 86 mm
5	7 300 86	2 gang unswitched Nominal plate dimensions: 86 x 146 mm
10	7 300 68	<b>Socket outlets 5 A - 250 V~</b> Conform to BS 546 Patented 3 pin safety shutter mechanism For flush-mounting, back box to be min. 25 mm deep Nominal plate dimensions: 86 x 86 mm 1 gang - unswitched
10	7 300 69	1 gang - switched, single pole
10	7 300 59	<b>Socket outlet 2 A - 250 V~</b> Conform to BS 546 For flush-mounting, back box to be min. 25 mm deep Nominal plate dimensions: 86 x 86 mm 1 gang - unswitched

## Synergy™

### Euro-US socket outlets and shaver socket - white



7 300 84



7 300 83



For German standard socket outlet use Cat.Nos 7 300 92 + 5 711 18

Front plates: white thermoset  
Terminal screws captive and backed off ready for cabling - large angled terminal entries  
Compact mechanism for maximised wiring space  
Supplied with faceplate screw caps

Pack	Cat.Nos	Socket outlet combined UK / Euro - US 13 A - 10/16 A
10	7 300 84	For flush-mounting, back box to be min. 25 mm deep Nominal plate dimensions: 86 x 86 mm 1 gang - unswitched UK - 13 A / EURO-US - 10/16 A - 250 V~
10	7 300 80	<b>Euro - US socket outlets</b> For flush-mounting, back box to be min. 25 mm deep Nominal plate dimensions: 86 x 86 mm 10 A - 127 V~ 16 A - 250 V~ 1 gang - unswitched
10	7 300 81	2 gang - unswitched
10	7 300 82	1 gang - switched
10	7 300 83	1 gang - unswitched + 10 AX 1 way switch
1	7 300 90	<b>Shaver socket</b> Conform to BS EN 61558-2-5 Suitable for use with European, British and Australian 2 pin plugs Rating: 20 VA IP 24 Screwless live and neutral terminals For flush-mounting, back box to be min. 45 mm deep Nominal plate dimensions: 146 x 86 mm 230 V - 120 V~ - 50/60 Hz

## Synergy™ - cooker control units, fused connection units and cable outlets - white



7 300 29



7 300 26

Front plates: white thermoset  
Terminal screws captive and backed off ready for cabling - large angled terminal entries  
Compact mechanism for maximised wiring space  
Supplied with faceplate screw caps

Pack	Cat.Nos	Cooker control units 250 V~
5	7 300 28	Conform to BS 4177 For flush-mounting, back box to be min. 45 mm deep Nominal plate dimensions: 86 x 146 mm 45 A DP switch + 13 A DP switched socket outlet
5	7 300 29	45 A DP switch + 13 A DP switched socket outlet + red LED power indicator LED invisible until activated
<b>Fused connection units 13 A - 250 V~</b>		
Conform to BS 1363: Part 4 Fused 13 A (fuse supplied) Front cable outlet with cord grip Locked captive fuse carrier (padlockable) For flush-mounting, back box to be min. 25 mm deep Nominal plate dimensions: 86 x 86 mm		
10	7 300 32	<b>Unswitched</b> With cord outlet
10	7 300 33	With red LED power indicator LED invisible until activated
10	7 300 36	<b>Double pole switched</b> With cord outlet
10	7 300 37	With red LED power indicator and cord outlet LED invisible until activated
<b>Cable outlets</b>		
Conform to BS 5733 Fitted with cable clamp and outlet membrane Nominal plate dimensions: 86 x 86 mm		
10	7 300 19	<b>20 A - 250 V~</b> For flush-mounting, back box to be min. 35 mm deep With terminal block
5	7 300 26	<b>45 A - 250 V~</b> For flush-mounting, back box to be min. 45 mm deep With terminal block

## Synergy™ - blanking plates, accessories and surface mounting boxes - white



7 300 96



7 301 58



7 364 06



7 364 11

Pack	Cat.Nos	Blanking plates
10	7 300 95	1 gang Nominal plate dimensions: 86 x 86 mm
10	7 300 96	2 gang Nominal plate dimensions: 86 x 146 mm
<b>Accessories</b>		
<b>Electronic LED</b>		
All relevant Synergy functions are designed to accept the LED packs for fitting at time of installation or retrospectively by qualified person Can be used with fluorescent light		
10	7 301 58	Electronic LED locator pack green diodes: max. current 0.2 mA provides illumination to locate function such as switches in low light
10	7 300 58	Electronic LED power indicator pack red diodes: nominal current 2 mA provides indication of "power on" condition in such functions as sockets and control switches
<b>Cord outlet</b>		
10	7 300 53	1 gang box Nominal plate dimensions: 86 x 86 mm
<b>Surface-mounting moulded boxes</b>		
10	7 364 06	1 gang, 35 mm deep 86 x 86 mm
10	7 364 07	1 gang, 50 mm deep and cable grip 86 x 86 mm
5	7 364 10	2 gang, 35 mm deep 86 x 146 mm
5	7 364 11	2 gang, 50 mm deep and cable grip 86 x 146 mm
5	7 364 13	2 x 1 gang, 35 mm deep 86 x 172 mm

# Synergy™ Modern

Blending the contemporary style of silver and nickel, Synergy's Modern accessories help create relaxing environments where everyone feels at home

## FORM AND FUNCTION IN PERFECT HARMONY

- Contemporary metal plates with hidden screws
- Terminal screws captive and backed off ready for cabling



Silver and Nickel (see opposite)

Grid system (p. 542)

## Synergy™

### single pole switches - Modern



7 310 00

7 310 02

7 310 07

Terminal screws captive and backed off ready for cabling - large angled terminal entries

Compact mechanism for maximised wiring space

Pack	Cat.Nos	Single pole plate switches 10 AX - 250 V~
1	7 310 00	Conform to BS EN 60669-1 For flush-mounting, back box to be min. 16 mm deep <b>1 gang - 1-way switch</b> Nominal plate dimensions: 89 x 89 mm ● Silver ● Nickel
1	7 312 00	
1	7 310 01	<b>1 gang - 2-way switch</b> Nominal plate dimensions: 89 x 89 mm ● Silver ● Nickel
1	7 312 01	
1	7 310 05	<b>1 gang - intermediate switch</b> Nominal plate dimensions: 89 x 89 mm ● Silver ● Nickel
1	7 312 05	
1	7 310 02	<b>2 gang - 2-way switch</b> Nominal plate dimensions: 89 x 89 mm ● Silver ● Nickel
1	7 312 02	
1	7 310 03	<b>3 gang - 2-way switch</b> Nominal plate dimensions: 89 x 89 mm ● Silver ● Nickel
1	7 312 03	
1	7 310 04	<b>4 gang - 2-way switch</b> Nominal plate dimensions: 89 x 149 mm ● Silver ● Nickel
1	7 312 04	
<b>Single pole plate switches 20 AX - 250 V~</b> Conform to BS EN 60669-1 For flush-mounting, back box to be min. 16 mm deep		
1	7 311 31	<b>1 gang - 2-way switch</b> Nominal plate dimensions: 89 x 89 mm ● Silver ● Nickel
1	7 313 31	
1	7 311 32	<b>2 gang - 2-way switch</b> Nominal plate dimensions: 89 x 89 mm ● Silver ● Nickel
1	7 313 32	
<b>Single pole push switches 10 A - 250 V~</b> Conform to BS EN 60669-1 For flush-mounting, back box to be min. 16 mm deep		
1	7 310 07	<b>1 gang - 2-way push switch</b> Nominal plate dimensions: 89 x 89 mm ● Silver ● Nickel
1	7 312 07	

# Synergy™

## dimmers, isolator switches and double pole switches - Modern



7 313 57



7 312 09



7 310 10



7 310 12



7 310 23

Terminal screws captive and backed off ready for cabling - large angled terminal entries  
Compact mechanism for maximised wiring space

Pack	Cat.Nos	<b>Push on/off rotary dimmers 400 W 100 - 240 V~ - 50/60 Hz</b>
1	7 311 56	<p>Conform to BS EN 60669-1-2 For flush-mounting, back box to be min. 25 mm deep</p> <p><b>1 gang - 2-way</b> Nominal plate dimensions: 89 x 89 mm</p> <p>● Silver ● Nickel</p>
1	7 313 56	
1	7 311 57	<p><b>2 gang - 2-way</b> Nominal plate dimensions: 89 x 89 mm</p> <p>● Silver ● Nickel</p>
1	7 313 57	
10	7 310 09	<p><b>3 pole fan switch 10 A - 250 V~</b></p> <p>Conform to BS EN 60669-1: 2000 With integrated padlockable safety block in OFF position Flush mounting back box: min. 25 mm deep Nominal plate dimensions: 86 x 86 mm</p> <p>● Silver ● Nickel</p>
10	7 312 09	

Pack	Cat.Nos	<b>Double pole switches 20 A - 250 V~</b>
1	7 310 10	<p>Conform to BS EN 60669-1 For flush-mounting, back box to be min. 25 mm deep</p> <p><b>DP switch</b> Nominal plate dimensions: 89 x 89 mm</p> <p>● Silver ● Nickel</p>
1	7 312 10	
1	7 310 16	<p><b>DP switch + cord outlet + red LED power indicator</b> LED invisible until activated Nominal plate dimensions: 89 x 89 mm</p> <p>● Silver ● Nickel</p>
1	7 312 16	
1	7 310 12	<p><b>DP switch + red LED power indicator</b> LED invisible until activated Nominal plate dimensions: 89 x 89 mm</p> <p>● Silver ● Nickel</p>
1	7 312 12	
1	7 310 23	<p><b>Double pole switches 45 A - 250 V~</b></p> <p>Conform to BS EN 60669-1 For flush-mounting, back box to be min. 45 mm deep Red rocker</p> <p><b>DP switch + red LED</b> Led invisible until activated Nominal plate dimensions: 89 x 89 mm</p> <p>● Silver ● Nickel</p>
1	7 312 23	



7 310 50



7 312 54



7 310 57

Terminal screws captive and backed off ready for cabling - large angled terminal entries  
Compact mechanism for maximised wiring space

Pack	Cat.Nos	Telephone sockets
1	7 310 50	<b>UK master</b> For flush-mounting, back box to be min. 35 mm deep Nominal plate dimensions: 89 x 89 mm ● Silver ● Nickel
1	7 312 50	
1	7 310 51	<b>UK secondary</b> For flush-mounting, back box to be min. 35 mm deep Nominal plate dimensions: 89 x 89 mm ● Silver ● Nickel
1	7 312 51	
1	7 310 54	<b>RJ 11 / RJ 12 - single</b> For flush-mounting, back box to be min. 35 mm deep Nominal plate dimensions: 89 x 89 mm ● Silver ● Nickel
1	7 312 54	

Pack	Cat.Nos	Data sockets Cat. 6
1	7 310 56	<b>RJ 45 - single</b> Rapid cable connection For flush-mounting, back box to be min. 35 mm deep Nominal plate dimensions: 89 x 89 mm ● Silver ● Nickel
1	7 312 56	
1	7 310 57	<b>RJ 45 - twin</b> Rapid cable connection For flush-mounting, back box to be min. 35 mm deep Nominal plate dimensions: 89 x 89 mm ● Silver ● Nickel
1	7 312 57	

Pack	Cat.Nos	Television sockets
1	7 310 40	<b>TV socket - single male</b> For flush-mounting, back box to be min. 35 mm deep Screened Nominal plate dimensions: 89 x 89 mm ● Silver ● Nickel
1	7 312 40	
1	7 310 41	<b>SAT socket - single "F" type</b> For flush-mounting, back box to be min. 35 mm deep Screened Nominal plate dimensions: 89 x 89 mm ● Silver ● Nickel
1	7 312 41	

# Synergy™

## British standard socket outlets - Modern



7 310 60



7 312 61



7 312 71



7 310 89

Terminal screws captive and backed off ready for cabling - large angled terminal entries  
Compact mechanism for maximised wiring space

Pack	Cat.Nos	Socket outlets 13 A - 250 V~
1	7 310 65	<p>Conform to BS EN 1363: Part. 2 Patented 3 pin safety shutters mechanism 2 earth terminals For flush-mounting, back box to be min. 35 mm deep</p> <p><b>1 gang unswitched</b> Nominal plate dimensions: 89 x 89 mm</p> <p> ● Silver ● Nickel</p>
1	7 312 65	
1	7 310 75	<p><b>2 gang unswitched</b> Nominal plate dimensions: 89 x 149 mm</p> <p> ● Silver ● Nickel</p>
1	7 312 75	
1	7 310 60	<p><b>Double pole socket outlets 13 A - 250 V~</b></p> <p>Conform to BS EN 1363: Part. 2 Patented 3 pin safety shutters mechanism 2 earth terminals Rapid cable connection For flush-mounting, back box to be min. 25 mm deep</p> <p><b>1 gang switched</b> Nominal plate dimensions: 89 x 89 mm</p> <p> ● Silver ● Nickel</p>
1	7 312 60	
1	7 310 61	<p><b>1 gang switched with red LED</b> LED invisible until activated Nominal plate dimensions: 89 x 89 mm</p> <p> ● Silver ● Nickel</p>
1	7 312 61	
1	7 310 70	<p><b>2 gang switched</b> Nominal plate dimensions: 89 x 149 mm</p> <p> ● Silver ● Nickel</p>
1	7 312 70	
1	7 310 71	<p><b>2 gang switched with red LED</b> LED invisible until activated Nominal plate dimensions: 89 x 149 mm</p> <p> ● Silver ● Nickel</p>
1	7 312 71	

Pack	Cat.Nos	Socket outlets 15 A - 250 V~
1	7 310 89	<p>Conform to BS 546 Patented 3 pin safety shutters mechanism For flush-mounting, back box to be min. 35 mm deep</p> <p><b>1 gang switched</b> Nominal plate dimensions: 89 x 89 mm</p> <p> ● Silver ● Nickel</p>
1	7 312 89	
1	7 310 85	<p><b>Socket outlets 15 A - 127 V~</b></p> <p>For flush-mounting, back box to be min. 35 mm deep</p> <p><b>1 gang unswitched</b> Nominal plate dimensions: 89 x 89 mm</p> <p> ● Silver ● Nickel</p>
1	7 312 85	
1	7 310 86	<p><b>2 gang unswitched</b> Nominal plate dimensions: 89 x 149 mm</p> <p> ● Silver ● Nickel</p>
1	7 312 86	
1	7 310 68	<p><b>Socket outlets 5 A - 250 V~</b></p> <p>Conform to BS 546 Patented 3 pin safety shutters mechanism For flush-mounting, back box to be min. 25 mm deep</p> <p><b>1 gang unswitched</b> Nominal plate dimensions: 89 x 89 mm</p> <p> ● Silver ● Nickel</p>
1	7 312 68	
1	7 310 69	<p><b>1 gang switched</b> Nominal plate dimensions: 89 x 89 mm</p> <p> ● Silver ● Nickel</p>
1	7 312 69	



7 312 30



7 310 33



7 312 34



7 310 35

Terminal screws captive and backed off ready for cabling - large angled terminal entries  
Compact mechanism for maximised wiring space

Pack	Cat.Nos	<b>Fused connection units unswitched 13 A - 250 V~</b>
1	7 310 32	<b>Unswitched - with cord outlet</b> Conform to BS 1363: Part. 4 Front cable outlet with cord grip Fuses supplied Locked captive fuse carrier (padlockable) For flush-mounting, back box to be min. 25 mm deep Nominal plate dimensions: 89 x 89 mm
1	7 312 32	
1	7 310 30	<b>Unswitched - without cord outlet</b> Conform to BS 1363: Part. 4 Front cable outlet with cord grip Fuses supplied Locked captive fuse carrier (padlockable) For flush-mounting, back box to be min. 25 mm deep Nominal plate dimensions: 89 x 89 mm
1	7 312 30	
1	7 310 31	<b>Unswitched - with red LED power indicator</b> LED invisible until activated Nominal plate dimensions: 89 x 89 mm
1	7 312 31	
1	7 310 33	<b>Unswitched - with red LED power indicator + cord outlet</b> LED invisible until activated Nominal plate dimensions: 89 x 89 mm
1	7 312 33	

Pack	Cat.Nos	<b>Fused connection units switched 13 A - 250 V~</b>
1	7 310 34	<b>DP switched - without cord outlet</b> Conform to BS 1363: Part. 4 Front cable outlet with cord grip Fuses supplied Locked captive fuse carrier (padlockable) For flush-mounting, back box to be min. 25 mm deep Nominal plate dimensions: 89 x 89 mm
1	7 312 34	
1	7 310 35	<b>DP switched - with red LED power indicator</b> LED invisible until activated Nominal plate dimensions: 89 x 89 mm
1	7 312 35	
1	7 310 37	<b>DP switched - with red LED power indicator + cord outlet</b> LED invisible until activated Nominal plate dimensions: 89 x 89 mm
1	7 312 37	



## Synergy™

### shaver sockets, cooker control units and cable outlets - Modern



7 310 29



7 312 19

Terminal screws captive and backed off ready for cabling - large angled terminal entries  
Compact mechanism for maximised wiring space

## Synergy™

### blanking plates, cord outlets - Modern



7 310 95



7 310 52

Terminal screws captive and backed off ready for cabling - large angled terminal entries  
Compact mechanism for maximised wiring space

Pack	Cat.Nos	Shaver sockets
1	7 310 90	<p>Conform to BS EN 61558-2-5 Suitable for use with European, British and Australian 2 pin plugs Rating: 20 VA IP 24 Screwless live and neutral terminals For flush-mounting, back box to be min. 45 mm deep <b>230 V / 120 V - 50/60 Hz</b> Nominal plate dimensions: 149 x 89 mm</p> <p>● Silver ● Nickel</p>
1	7 312 90	

Pack	Cat.Nos	Cooker control units - 250 V~
1	7 310 29	<p>Conform to BS 4177: 1992 For flush-mounting, back box to be min. 47 mm deep <b>45 A DP switch + 13 A DP switched socket outlet</b> Nominal plate dimensions: 89 x 149 mm</p> <p>● Silver ● Nickel</p>
1	7 312 29	

Pack	Cat.Nos	Cable outlets
1	7 310 19	<p>Conform to BS 5733 Fitted with clamp and outlet membrane <b>20 A - 250 V~</b> Nominal plate dimensions: 89 x 89 mm</p> <p>● Silver ● Nickel</p>
1	7 312 19	
1	7 310 26	<p><b>45 A - 250 V~</b> Nominal plate dimensions: 89 x 89 mm</p> <p>● Silver ● Nickel</p>
1	7 312 26	

Pack	Cat.Nos	Blanking plates
1	7 310 95	<p><b>1 gang</b> Nominal plate dimensions: 89 x 89 mm</p> <p>● Silver ● Nickel</p>
1	7 312 95	
1	7 310 96	<p><b>2 gang</b> Nominal plate dimensions: 89 x 89 mm</p> <p>● Silver ● Nickel</p>
1	7 312 96	
1	7 310 52	<p><b>Cord outlets</b> <b>1 gang</b> Nominal plate dimensions: 89 x 89 mm</p> <p>● Silver ● Nickel</p>
1	7 312 52	



Slim front plates:

BSS: Electro plated brushed stainless steel with clear epoxy lacquer coating

PSS: Electro plated stainless steel with trivalent chrome for mirror finish

SB: Electro plated stainless steel with electrophoretic satin brass lacquer

Terminal screws captive and backed off ready for cabling - large angled terminal entries

Compact mechanism for maximised wiring space

Pack	Cat.Nos	Single pole plate switches 10 AX - 250 V $\sim$
		Conform to BS EN 60669-1 For flush-mounting, back box to be min. 16 mm deep
		<b>1 gang - 1-way switch</b> Nominal plate dimensions: 86 x 86 mm
1	7 330 00	Brushed stainless steel
1	7 332 00	Polished stainless steel
1	7 334 00	Satin brass
		<b>1 gang - 2-way switch</b> Nominal plate dimensions: 86 x 86 mm
1	7 330 01	Brushed stainless steel
1	7 332 01	Polished stainless steel
1	7 334 01	Satin brass
		<b>1 gang - intermediate switch</b> Nominal plate dimensions: 86 x 86 mm
1	7 330 05	Brushed stainless steel
1	7 332 05	Polished stainless steel
1	7 334 05	Satin brass
		<b>2 gang - 2-way switch</b> Nominal plate dimensions: 86 x 86 mm
1	7 330 02	Brushed stainless steel
1	7 332 02	Polished stainless steel
1	7 334 02	Satin brass
		<b>3 gang - 2-way switch</b> Nominal plate dimensions: 86 x 86 mm
1	7 330 03	Brushed stainless steel
1	7 332 03	Polished stainless steel
1	7 334 03	Satin brass
		<b>4 gang - 2-way switch</b> Nominal plate dimensions: 86 x 146 mm
1	7 330 04	Brushed stainless steel
1	7 332 04	Polished stainless steel
1	7 334 04	Satin brass

Pack	Cat.Nos	Single pole push switches 10 A - 250 V $\sim$
		Conform to BS EN 60669-1 For flush-mounting, back box to be min. 16 mm deep
		<b>1 gang - 2-way push switch</b> Nominal plate dimensions: 86 x 86 mm
1	7 330 07	Brushed stainless steel
1	7 332 07	Polished stainless steel
1	7 334 07	Satin brass

Pack	Cat.Nos	Single pole plate switches 20 AX - 250 V $\sim$
		Conform to BS EN 60669-1 For flush-mounting, back box to be min. 16 mm deep
		<b>1 gang - 2-way switch</b> Nominal plate dimensions: 86 x 86 mm
1	7 331 31	Brushed stainless steel
1	7 333 31	Polished stainless steel
1	7 335 31	Satin brass
		<b>2 gang - 2-way switch</b> Nominal plate dimensions: 86 x 86 mm
1	7 331 32	Brushed stainless steel
1	7 333 32	Polished stainless steel
1	7 335 32	Satin brass
		<b>3 gang - 2-way switch</b> Nominal plate dimensions: 86 x 86 mm
1	7 331 33	Brushed stainless steel

Pack	Cat.Nos	Push on/off rotary dimmers 400 W 100-240 V $\sim$ - 50/60 Hz
		Conform to BS EN 60669-1-2 For flush-mounting, back box to be min. 25 mm deep
		<b>1 gang - 2 way</b> Nominal plate dimensions: 86 x 86 mm
1	7 331 56	Brushed stainless steel
1	7 333 56	Polished stainless steel
1	7 335 56	Satin brass
		<b>2 gang - 2 way</b> Nominal plate dimensions: 86 x 86 mm
1	7 331 57	Brushed stainless steel
1	7 333 57	Polished stainless steel
1	7 335 57	Satin brass

Pack	Cat.Nos	3 pole fan switch 10 A - 250 V $\sim$
		Conform to BS EN 60669-1: 2000 With integrated padlockable safety block in OFF position Flush mounting back box: min. 25 mm deep Nominal plate dimensions: 86 x 86 mm
1	7 330 09	Brushed stainless steel
1	7 332 09	Polished stainless steel
1	7 334 09	Satin brass

# Synergy™

## double pole switches - Traditional



Slim front plates:

BSS: Electro plated brushed stainless steel with clear epoxy satin lacquer coating

PSS: Electro plated stainless steel with trivalent chrome for mirror finish

SB: Electro plated stainless steel with electrophoretic satin brass lacquer

Terminal screws captive and backed off ready for cabling - large angled terminal entries

Compact mechanism for maximised wiring space

Pack	Cat.Nos	Double pole switches 20 A - 250 V~
		Conform to BS EN 60669-1 For flush-mounting, back box to be min. 25 mm deep Use cord outlet accessory Cat.No 7 300 53 (p. 521) for external cord outlet
		<b>Double pole switch</b> Nominal plate dimensions: 86 x 86 mm
1	7 330 10	Brushed stainless steel
1	7 332 10	Polished stainless steel
1	7 334 10	Satin brass
		<b>DP switch + cord outlet + red LED power indicator</b> LED invisible until activated Nominal plate dimensions: 86 x 86 mm
1	7 330 16	Brushed stainless steel
1	7 332 16	Polished stainless steel
1	7 334 16	Satin brass
		<b>DP switch + red LED power indicator</b> LED invisible until activated Nominal plate dimensions: 86 x 86 mm
1	7 330 12	Brushed stainless steel
1	7 332 12	Polished stainless steel
1	7 334 12	Satin brass

Pack	Cat.Nos	Double pole switches 45 A - 250 V~
		Conform to BS EN 60669-1 For flush-mounting, back box to be min. 45 mm deep
		<b>1 gang switch</b> Nominal plate dimensions: 86 x 86 mm
1	7 330 22	Brushed stainless steel
1	7 332 22	Polished stainless steel
		<b>1 gang switch + red LED power indicator</b> LED invisible until activated Nominal plate dimensions: 86 x 86 mm
1	7 330 23	Brushed stainless steel
1	7 332 23	Polished stainless steel
1	7 334 23	Satin brass
		<b>1 gang switch + red LED power indicator large plate</b> LED invisible until activated Nominal plate dimensions: 146 x 86 mm
1	7 330 21	Brushed stainless steel
1	7 332 21	Polished stainless steel
1	7 334 21	Satin brass



Slim front plates:  
 BSS: Electro plated brushed stainless steel with clear epoxy satin lacquer coating  
 PSS: Electro plated stainless steel with trivalent chrome for mirror finish  
 SB: Electro plated stainless steel with electrophoretic satin brass lacquer  
 Terminal screws captive and backed off ready for cabling - large angled terminal entries  
 Compact mechanism for maximised wiring space

Pack	Cat.Nos	Telephone sockets	Pack	Cat.Nos	Television sockets
		For flush-mounting, back box to be min. 35 mm deep			For flush-mounting, back box to be min. 35 mm deep
		<b>UK master</b>			Screened
		Nominal plate dimensions: 86 x 86 mm			<b>TV socket - single male</b>
1	7 330 50	Brushed stainless steel	1	7 330 40	Brushed stainless steel
1	7 332 50	Polished stainless steel	1	7 332 40	Polished stainless steel
1	7 334 50	Satin brass	1	7 334 40	Satin brass
		<b>UK secondary</b>			<b>SAT socket - single "F" type</b>
		Nominal plate dimensions: 86 x 86 mm			Nominal plate dimensions: 86 x 86 mm
1	7 330 51	Brushed stainless steel	1	7 330 41	Brushed stainless steel
1	7 332 51	Polished stainless steel	1	7 332 41	Polished stainless steel
1	7 334 51	Satin brass	1	7 334 41	Satin brass
		<b>RJ 11/RJ 12 - single</b>			<b>TV-R socket</b>
		Nominal plate dimensions: 86 x 86 mm			Nominal plate dimensions: 86 x 86 mm
1	7 330 54	Brushed stainless steel	1	7 330 42	Brushed stainless steel
1	7 332 54	Polished stainless steel	1	7 332 42	Polished stainless steel
1	7 334 54	Satin brass			<b>TV-R-SAT socket - "F" type</b>
		<b>Data sockets Cat. 6</b>			Nominal plate dimensions: 86 x 86 mm
		Rapid cable connection			
		For flush-mounting, back box to be min. 35 mm deep	1	7 330 43	Brushed stainless steel
		<b>RJ 45 - single</b>	1	7 332 43	Polished stainless steel
		Nominal plate dimensions: 86 x 86 mm	1	7 334 43	Satin brass
1	7 330 56	Brushed stainless steel			
1	7 332 56	Polished stainless steel			
1	7 334 56	Satin brass			
		<b>RJ 45 - twin</b>			
		Nominal plate dimensions: 86 x 86 mm			
1	7 330 57	Brushed stainless steel			
1	7 332 57	Polished stainless steel			
1	7 334 57	Satin brass			



Slim front plates:

BSS: Electro plated brushed stainless steel with clear epoxy satin lacquer coating

PSS: Electro plated stainless steel with trivalent chrome for mirror finish

SB: Electro plated stainless steel with electrophoretic satin brass lacquer

Terminal screws captive and backed off ready for cabling - large angled terminal entries

Compact mechanism for maximised wiring space

Pack	Cat.Nos	Socket outlets 13 A - 250 V~	Pack	Cat.Nos	Socket outlets 15 A - 250 V~
		<p>Conform to BS 1363: Part. 2 Patented 3 pin safety shutters mechanism 2 earth terminals For flush-mounting, back box to be min. 25 mm deep</p> <p><b>1 gang unswitched</b> Nominal plate dimensions: 86 x 86 mm</p> <p>1 7 330 65  Brushed stainless steel 1 7 332 65  Polished stainless steel 1 7 334 65  Satin brass</p> <p><b>2 gang unswitched</b> Nominal plate dimensions: 86 x 146 mm</p> <p>1 7 330 75  Brushed stainless steel 1 7 332 75  Polished stainless steel 1 7 334 75  Satin brass</p>			<p>Conform to BS 546 Patented 3 pin safety shutters mechanism, For flush-mounting, back box to be min. 35 mm deep</p> <p><b>1 gang unswitched</b> Nominal plate dimensions: 86 x 86 mm</p> <p>1 7 330 88  Brushed stainless steel</p> <p><b>1 gang switched - single pole</b> Nominal plate dimensions: 86 x 86 mm</p> <p>1 7 330 89  Brushed stainless steel 1 7 332 89  Polished stainless steel 1 7 334 89  Satin brass</p>
		<p><b>Double pole socket outlets 13 A - 250 V~</b></p> <p>Conform to BS 1363: Part. 2 Patented 3 pin safety shutters mechanism, 2 earth terminals For flush-mounting, back box to be min. 25 mm deep</p> <p><b>1 gang switched</b> Nominal plate dimensions: 86 x 86 mm</p> <p>1 7 330 60  Brushed stainless steel 1 7 332 60  Polished stainless steel 1 7 334 60  Satin brass</p> <p><b>1 gang switched with red LED power indicator</b> LED invisible until activated Nominal plate dimensions: 86 x 86 mm</p> <p>1 7 330 61  Brushed stainless steel 1 7 332 61  Polished stainless steel 1 7 334 61  Satin brass</p> <p><b>2 gang switched</b> Nominal plate dimensions: 86 x 146 mm</p> <p>1 7 330 70  Brushed stainless steel 1 7 332 70  Polished stainless steel 1 7 334 70  Satin brass</p> <p><b>2 gang switched with red LED power indicator</b> LED invisible until activated Nominal plate dimensions: 86 x 146 mm</p> <p>1 7 330 71  Brushed stainless steel 1 7 332 71  Polished stainless steel 1 7 334 71  Satin brass</p> <p><b>2 gang switched outboard for standard and clean earth applications</b> Nominal plate dimensions: 86 x 146 mm</p> <p>1 7 330 74  Brushed stainless steel 1 7 332 74  Polished stainless steel 1 7 334 74  Satin brass</p>			<p>For flush-mounting, back box to be min. 35 mm deep</p> <p><b>1 gang</b> Nominal plate dimensions: 86 x 86 mm</p> <p>1 7 330 85  Brushed stainless steel 1 7 332 85  Polished stainless steel 1 7 334 85  Satin brass</p> <p><b>2 gang</b> Nominal plate dimensions: 86 x 146 mm</p> <p>1 7 330 86  Brushed stainless steel 1 7 332 86  Polished stainless steel 1 7 334 86  Satin brass</p>
					<p><b>Socket outlets 5 A - 250 V~</b></p> <p>Conform to BS 546 Patented 3 pin safety shutters mechanism, For flush-mounting, back box to be min. 25 mm deep</p> <p><b>1 gang unswitched</b> Nominal plate dimensions: 86 x 86 mm</p> <p>1 7 330 68  Brushed stainless steel 1 7 332 68  Polished stainless steel 1 7 334 68  Satin brass</p> <p><b>1 gang switched - single pole</b> Nominal plate dimensions: 86 x 146 mm</p> <p>1 7 330 69  Brushed stainless steel 1 7 332 69  Polished stainless steel 1 7 334 69  Satin brass</p>
					<p><b>Socket outlets 2 A - 250 V~</b></p> <p>Conform to BS 546 For flush-mounting, back box to be min. 25 mm deep</p> <p><b>1 gang unswitched</b> Nominal plate dimensions: 86 x 86 mm</p> <p>1 7 330 59  Brushed stainless steel 1 7 332 59  Polished stainless steel 1 7 334 59  Satin brass</p>



7 330 32



7 334 37



7 332 97



7 332 29

Slim front plates:

BSS: Electro plated brushed stainless steel with clear epoxy satin lacquer coating

PSS: Electro plated stainless steel with trivalent chrome for mirror finish

SB: Electro plated stainless steel with electrophoretic satin brass lacquer

Terminal screws captive and backed off ready for cabling - large angled terminal entries

Compact mechanism for maximised wiring space

Pack	Cat.Nos	Fused connection units 13 A - 250 V~
		Conform to BS 1363: Part. 4 Front cable outlet with cord grip Locked captive fuse carrier (padlockable) For flush-mounting, back box to be min. 25 mm deep
1	7 330 32	<b>Unswitched with cord outlet</b> Nominal plate dimensions: 86 x 86 mm
1	7 332 32	● Brushed stainless steel
1	7 334 32	● Polished stainless steel
		<b>Unswitched without cord outlet</b> Nominal plate dimensions: 86 x 86 mm
1	7 330 30	● Brushed stainless steel
1	7 332 30	● Polished stainless steel
1	7 334 30	● Satin brass
		<b>Unswitched with red LED power indicator</b> Nominal plate dimensions: 86 x 86 mm
1	7 330 31	● Brushed stainless steel
1	7 332 31	● Polished stainless steel
1	7 334 31	● Satin brass
		<b>Unswitched with red LED power indicator + cord outlet</b> Nominal plate dimensions: 86 x 86 mm
1	7 330 33	● Brushed stainless steel
1	7 332 33	● Polished stainless steel
1	7 334 33	● Satin brass
		<b>DP switched without cord outlet</b> Nominal plate dimensions: 86 x 146 mm
1	7 330 34	● Brushed stainless steel
1	7 332 34	● Polished stainless steel
1	7 334 34	● Satin brass
		<b>DP switched with red LED power indicator</b> Nominal plate dimensions: 86 x 146 mm
1	7 330 35	● Brushed stainless steel
1	7 332 35	● Polished stainless steel
1	7 334 35	● Satin brass
		<b>DP switched with red LED power indicator + cord outlet</b> Nominal plate dimensions: 86 x 146 mm
1	7 330 37	● Brushed stainless steel
1	7 332 37	● Polished stainless steel
1	7 334 37	● Satin brass

Pack	Cat.Nos	RCD sockets 13 A - 250 V~
		Conform to BS 7288 and BS 1363: Part. 2 Maximum operating current 16 A Incorporates a «test and reset» button For flush-mounting, back box to be min. 25 mm deep
		<b>2 gang - DP 30 mA</b> <b>Active: Electrical latching trips on power failure</b> Nominal plate dimensions: 86 x 146 mm
1	7 330 97	● Brushed stainless steel
1	7 332 97	● Polished stainless steel
1	7 334 97	● Satin brass
		<b>2 gang - DP 30 mA</b> <b>Passive: Mechanical latching does not trip on power failure</b> Nominal plate dimensions: 86 x 146 mm
1	7 330 98	● Brushed stainless steel
1	7 332 98	● Polished stainless steel
1	7 334 98	● Satin brass
		<b>Cooker control units - 250 V~</b> Conform to BS 4177: 1992 For flush-mounting, back box to be min. 47 mm deep
		<b>45 A DP switch + 13 A DP switched socket outlet with red LED power indicator</b> Nominal plate dimensions: 86 x 146 mm
1	7 330 29	● Brushed stainless steel
1	7 332 29	● Polished stainless steel
1	7 334 29	● Satin brass

# Synergy™

## shaver sockets, cable outlets, blanking plates and cord outlets - Traditional



7 332 90



7 330 19



7 334 95



7 332 96



7 332 52

Slim front plates:

BSS: Electro plated brushed stainless steel with clear epoxy satin lacquer coating



PSS: Electro plated stainless steel with trivalent chrome for mirror finish



SB: Electro plated stainless steel with electrophoretic satin brass lacquer

Terminal screws captive and backed off ready for cabling - large angled terminal entries

Compact mechanism for maximised wiring space

Pack	Cat.Nos	Shaver sockets
		Conform to BS EN 61558-2-5 Suitable for use with European, British and Australian 2 pin plugs Rating: 20 VA IP 24 Screwless live and neutral terminals For flush-mounting, back box to be min. 45 mm deep
		<b>230/120 V~ - 50/60 Hz</b> Nominal plate dimensions: 146 x 86 mm
1	7 330 90	 <span style="display: inline-block; width: 10px; height: 10px; background-color: #ccc; border: 1px solid #000; margin-right: 5px;"></span> Brushed stainless steel
1	7 332 90	<span style="display: inline-block; width: 10px; height: 10px; background-color: #eee; border: 1px solid #000; margin-right: 5px;"></span> Polished stainless steel
1	7 334 90	<span style="display: inline-block; width: 10px; height: 10px; background-color: #ffcc00; border: 1px solid #000; margin-right: 5px;"></span> Satin brass

Pack	Cat.Nos	Cable outlets
		Conform to BS 5733 Fitted clamp and outlet membrane With terminal block
		<b>20 A - 250 V~</b> Nominal plate dimensions: 86 x 86 mm
1	7 330 19	 <span style="display: inline-block; width: 10px; height: 10px; background-color: #ccc; border: 1px solid #000; margin-right: 5px;"></span> Brushed stainless steel
1	7 332 19	<span style="display: inline-block; width: 10px; height: 10px; background-color: #eee; border: 1px solid #000; margin-right: 5px;"></span> Polished stainless steel
1	7 334 19	<span style="display: inline-block; width: 10px; height: 10px; background-color: #ffcc00; border: 1px solid #000; margin-right: 5px;"></span> Satin brass
		<b>45 A - 250 V~</b> Nominal plate dimensions: 86 x 86 mm
1	7 330 26	 <span style="display: inline-block; width: 10px; height: 10px; background-color: #ccc; border: 1px solid #000; margin-right: 5px;"></span> Brushed stainless steel
1	7 332 26	<span style="display: inline-block; width: 10px; height: 10px; background-color: #eee; border: 1px solid #000; margin-right: 5px;"></span> Polished stainless steel
1	7 334 26	<span style="display: inline-block; width: 10px; height: 10px; background-color: #ffcc00; border: 1px solid #000; margin-right: 5px;"></span> Satin brass

Pack	Cat.Nos	Blanking plates
		<b>1 gang</b> Nominal plate dimensions: 86 x 86 mm
1	7 330 95	 <span style="display: inline-block; width: 10px; height: 10px; background-color: #ccc; border: 1px solid #000; margin-right: 5px;"></span> Brushed stainless steel
1	7 332 95	<span style="display: inline-block; width: 10px; height: 10px; background-color: #eee; border: 1px solid #000; margin-right: 5px;"></span> Polished stainless steel
1	7 334 95	<span style="display: inline-block; width: 10px; height: 10px; background-color: #ffcc00; border: 1px solid #000; margin-right: 5px;"></span> Satin brass
		<b>2 gang</b> Nominal plate dimensions: 86 x 146 mm
1	7 330 96	 <span style="display: inline-block; width: 10px; height: 10px; background-color: #ccc; border: 1px solid #000; margin-right: 5px;"></span> Brushed stainless steel
1	7 332 96	<span style="display: inline-block; width: 10px; height: 10px; background-color: #eee; border: 1px solid #000; margin-right: 5px;"></span> Polished stainless steel
1	7 334 96	<span style="display: inline-block; width: 10px; height: 10px; background-color: #ffcc00; border: 1px solid #000; margin-right: 5px;"></span> Satin brass
		<b>Cord outlets</b>
		<b>1 gang</b> Nominal plate dimensions: 86 x 86 mm
1	7 330 52	 <span style="display: inline-block; width: 10px; height: 10px; background-color: #ccc; border: 1px solid #000; margin-right: 5px;"></span> Brushed stainless steel
1	7 332 52	<span style="display: inline-block; width: 10px; height: 10px; background-color: #eee; border: 1px solid #000; margin-right: 5px;"></span> Polished stainless steel
1	7 334 52	<span style="display: inline-block; width: 10px; height: 10px; background-color: #ffcc00; border: 1px solid #000; margin-right: 5px;"></span> Satin brass



# Synergy™

## Flat plate



■ In today's world of shrinking proportions, the key trend is towards slenderness and simplicity of design

With a true flat plate design, the latest addition to the Synergy family is simply stunning...Whichever way you look at it

### FROM A SINGLE SWITCH TO **MULTI-FUNCTION MODULAR SOLUTIONS**

#### ELEGANT PROFILE

- A true flat plate design
- High quality components and advanced manufacturing techniques
- Available in grid modules version for more complex installations



Antique brass



Brushed stainless steel



Grid modules, p. 542



## Synergy™

### single pole switches and dimmers - Flat plate



7 343 31



7 343 32



7 342 47

Terminal screws captive and backed off ready for cabling - large angled terminal entries

Compact mechanism for maximised wiring space

Supplied with transparent protection cover and 4 fixing screws (2 long and 2 short screws)

## Synergy™

### double pole switches - Flat plate



7 346 12



7 342 23

Terminal screws captive and backed off ready for cabling - large angled terminal entries

Compact mechanism for maximised wiring space

Supplied with transparent protection cover and 4 fixing screws (2 long and 2 short screws)

Pack	Cat.Nos	Single pole plate switches 20 AX - 250 V~
1	7 343 31	<p>Conform to BS EN 60669-1 For flush-mounting, back box to be min. 35 mm deep</p> <p><b>1 gang - 2-way switch</b> Nominal plate dimensions: 86 x 86 mm</p> <ul style="list-style-type: none"> <li>● Antique Brass</li> <li>● Brushed stainless steel</li> </ul>
1	7 347 31	
1	7 343 32	<p><b>2 gang - 2-way switch</b> Nominal plate dimensions: 86 x 86 mm</p> <ul style="list-style-type: none"> <li>● Antique Brass</li> <li>● Brushed stainless steel</li> </ul>
1	7 347 32	
1	7 343 33	<p><b>3 gang - 2-way switch</b> Nominal plate dimensions: 86 x 86 mm</p> <ul style="list-style-type: none"> <li>● Antique Brass</li> <li>● Brushed stainless steel</li> </ul>
1	7 347 33	
1	7 343 34	<p><b>4 gang - 2-way switch</b> Nominal plate dimensions: 86 x 146 mm</p> <ul style="list-style-type: none"> <li>● Antique Brass</li> <li>● Brushed stainless steel</li> </ul>
1	7 347 34	

Pack	Cat.Nos	Single pole push switches 10 A - 250 V~
1	7 342 07	<p>Conform to BS EN 60669-1 For flush-mounting, back box to be min. 35 mm deep</p> <p><b>1 gang - 2-way push switch</b> Nominal plate dimensions: 86 x 86 mm</p> <ul style="list-style-type: none"> <li>● Antique Brass</li> <li>● Brushed stainless steel</li> </ul>
1	7 346 07	

Pack	Cat.Nos	Push on/off rotary dimmers 400 W 250 V~ - 50/60 Hz
1	7 342 46	<p>Conform to BS EN 60669-1 For flush-mounting, back box to be min. 35 mm deep</p> <p><b>1 gang - 2 way</b> Nominal plate dimensions: 86 x 86 mm</p> <ul style="list-style-type: none"> <li>● Antique Brass</li> <li>● Brushed stainless steel</li> </ul>
1	7 346 46	
1	7 342 47	<p><b>2 gang - 2 way</b> Nominal plate dimensions: 86 x 86 mm</p> <ul style="list-style-type: none"> <li>● Antique Brass</li> <li>● Brushed stainless steel</li> </ul>
1	7 346 47	

Pack	Cat.Nos	Double pole switches 20 A - 250 V~
1	7 342 10	<p>Conform to BS EN 60669-1 For flush-mounting, back box to be min. 35 mm deep Supplied with 1 gang frame (3 mm thick) Cat.No 7341 98 in case of extra wiring space needed</p> <p><b>DP switch</b> Nominal plate dimensions: 86 x 86 mm</p> <ul style="list-style-type: none"> <li>● Antique Brass</li> <li>● Brushed stainless steel</li> </ul>
1	7 346 10	
1	7 346 14	<p><b>DP switch + cord outlet</b> Nominal plate dimensions: 86 x 86 mm</p> <ul style="list-style-type: none"> <li>● Brushed stainless steel</li> </ul>
1	7 342 16	<p><b>DP switch + cord outlet + red LED power indicator</b> Nominal plate dimensions: 86 x 86 mm</p> <ul style="list-style-type: none"> <li>● Antique Brass</li> </ul>
1	7 342 12	<p><b>DP switch + red LED power indicator</b> Nominal plate dimensions: 86 x 86 mm</p> <ul style="list-style-type: none"> <li>● Antique Brass</li> <li>● Brushed stainless steel</li> </ul>
1	7 346 12	
1	7 342 23	<p><b>Double pole switches 45 A - 250 V~</b> Conform to BS EN 60669-1 For flush-mounting, back box to be min. 47 mm deep Red rocker</p> <p><b>DP switch + red LED power indicator</b> Nominal plate dimensions: 86 x 86 mm</p> <ul style="list-style-type: none"> <li>● Antique Brass</li> <li>● Brushed stainless steel</li> </ul>
1	7 346 23	



7 342 54



7 346 57



7 346 40



7 342 43

Terminal screws captive and backed off ready for cabling - large angled terminal entries  
 Compact mechanism for maximised wiring space  
 Supplied with transparent protection cover and 4 fixing screws (2 long and 2 short screws)

Pack	Cat.Nos	Telephone sockets	Pack	Cat.Nos	Television sockets
		For flush-mounting, back box to be min. 35 mm deep White rocker			For flush-mounting, back box to be min. 35 mm deep Screened
1	7 342 50	<b>UK master</b> Nominal plate dimensions: 86 x 86 mm	1	7 342 40	<b>TV sockets - single male</b> Nominal plate dimensions: 86 x 86 mm
1	7 346 50	● Antique Brass ● Brushed stainless steel	1	7 346 40	● Antique Brass ● Brushed stainless steel
1	7 342 51	<b>UK secondary</b> Nominal plate dimensions: 86 x 86 mm	1	7 342 41	<b>SAT sockets - single "F" type</b> Nominal plate dimensions: 86 x 86 mm
1	7 346 51	● Antique Brass ● Brushed stainless steel	1	7 346 41	● Antique Brass ● Brushed stainless steel
1	7 342 54	<b>RJ 11 / RJ 12 - single</b> Nominal plate dimensions: 86 x 86 mm	1	7 342 43	<b>TV-R-SAT sockets - "F" type</b> Nominal plate dimensions: 86 x 86 mm
1	7 346 54	● Antique Brass ● Brushed stainless steel	1	7 346 43	● Antique Brass ● Brushed stainless steel
		<b>Data sockets Cat. 6</b>			
		Rapid cable connection For flush-mounting, back box to be min. 35 mm deep			
1	7 342 56	<b>RJ 45 - single</b> Nominal plate dimensions: 86 x 86 mm			
1	7 346 56	● Antique Brass ● Brushed stainless steel			
1	7 342 57	<b>RJ 45 - twin</b> Nominal plate dimensions: 86 x 86 mm			
1	7 346 57	● Antique Brass ● Brushed stainless steel			

# Synergy™

## British standard socket outlets - Flat plate



7 346 75



7 342 61



7 346 89



7 342 59

Terminal screws captive and backed off ready for cabling - large angled terminal entries  
 Compact mechanism for maximised wiring space  
 Supplied with transparent protection cover and 4 fixing screws (2 long and 2 short screws)

Pack	Cat.Nos	Socket outlets 13 A - 250 V~	Pack	Cat.Nos	Socket outlets 15 A - 250 V~
1	7 342 65	<p>Conform to BS EN 1363: Part. 2                      Patented 3 pin safety shutters mechanism 2 earth terminals                      For flush-mounting, back box to be min. 35 mm deep</p> <p><b>1 gang unswitched</b>                      Nominal plate dimensions: 86 x 86 mm</p> <p>● Antique Brass                      ● Brushed stainless steel</p>	1	7 342 89	<p>Conform to BS 546                      Patented 3 pin safety shutters mechanism                      For flush-mounting, back box to be min. 35 mm deep</p> <p><b>1 gang switched</b>                      Nominal plate dimensions: 86 x 86 mm</p> <p>● Antique Brass                      ● Brushed stainless steel</p>
1	7 346 65		1	7 346 89	
1	7 342 75	<p><b>2 gang unswitched</b>                      Nominal plate dimensions: 86 x 146 mm</p> <p>● Antique Brass                      ● Brushed stainless steel</p>			<p><b>Socket outlets 5 A - 250 V~</b></p> <p>Conform to BS 546                      Patented 3 pin safety shutters mechanism                      For flush-mounting, back box to be min. 25 mm deep</p> <p><b>1 gang switched</b>                      Nominal plate dimensions: 86 x 86 mm</p> <p>● Antique Brass                      ● Brushed stainless steel</p>
1	7 346 75		1	7 342 69	
1	7 342 60	<p><b>Double pole socket outlets 13 A - 250 V~</b></p> <p>Conform to BS EN 1363: Part. 2                      Patented 3 pin safety shutters mechanism 2 earth terminals                      For flush-mounting, back box to be min. 35 mm deep</p> <p><b>1 gang switched</b>                      Nominal plate dimensions: 86 x 86 mm</p> <p>● Antique Brass                      ● Brushed stainless steel</p>			<p><b>Socket outlets 2 A - 250 V~</b></p> <p>Conform to BS 546                      For flush-mounting, back box to be min. 25 mm deep</p> <p><b>1 gang unswitched</b>                      Nominal plate dimensions: 86 x 86 mm</p> <p>● Antique Brass                      ● Brushed stainless steel</p>
1	7 346 60		1	7 342 59	
1	7 342 61	<p><b>1 gang switched with red LED power indicator</b>                      Nominal plate dimensions: 86 x 86 mm</p> <p>● Antique Brass                      ● Brushed stainless steel</p>			
1	7 346 61				
1	7 342 70	<p><b>2 gang switched</b>                      Nominal plate dimensions: 86 x 146 mm</p> <p>● Antique Brass                      ● Brushed stainless steel</p>			
1	7 346 70				
1	7 342 71	<p><b>2 gang switched with red LED power indicator</b>                      Nominal plate dimensions: 86 x 146 mm</p> <p>● Antique Brass                      ● Brushed stainless steel</p>			
1	7 346 71				



Terminal screws captive and backed off ready for cabling - large angled terminal entries  
 Compact mechanism for maximised wiring space  
 Supplied with transparent protection cover and 4 fixing screws (2 long and 2 short screws)

Pack	Cat.Nos		Pack	Cat.Nos	
		<b>Fused connection units unswitched</b> <b>13 A - 250 V~</b> Conform to BS 1363: Part. 4 Front cable outlet with cord grip Fuses supplied Locked captive fuse carrier (padlockable) For flush-mounting, back box to be min. 35 mm deep Supplied with 2 gang frame Cat.No 7 341 99 (3 mm thick) in case of extra wiring space needed			<b>Cooker control units - 250 V~</b> Conform to BS 4177: 1992 For flush-mounting, back box to be min 47 mm deep <b>45 A DP switch + 13 A DP switched socket outlet</b> Nominal plate dimensions: 86 x 146 mm
1	7 342 32	<b>Unswitched - with cord outlet</b> Nominal plate dimensions: 86 x 86 mm ● Antique Brass ● Brushed stainless steel	1	7 342 29	● Antique Brass ● Brushed stainless steel
1	7 346 32		1	7 346 29	
		<b>Fused connection units switched</b> <b>13 A - 250 V~</b> Conform to BS 1363: Part. 4 Front cable outlet with cord grip Fuses supplied Locked captive fuse carrier (padlockable) For flush-mounting, back box to be min. 35 mm deep Supplied with 2 gang frame Cat.No 7 341 99 (3 mm thick) in case of extra wiring space needed			<b>Cable outlets</b> Conform to BS 5733 Fitted with clamp and outlet membrane With terminal block <b>20 A - 250 V~</b> Nominal plate dimensions: 86 x 86 mm ● Antique Brass ● Brushed stainless steel
1	7 342 34	<b>DP switched - without cord outlet</b> Nominal plate dimensions: 86 x 86 mm ● Antique Brass ● Brushed stainless steel	1	7 342 19	● Antique Brass ● Brushed stainless steel
1	7 346 34		1	7 346 19	
1	7 342 37	<b>DP switched - with red LED power indicator + cord outlet</b> Nominal plate dimensions: 86 x 86 mm ● Antique Brass ● Brushed stainless steel	1	7 342 26	● Antique Brass ● Brushed stainless steel
1	7 346 37		1	7 346 26	
		<b>Shaver sockets</b> Conform to BS EN 61558-2-5 suitable for use with European, British, American and Australian 2 pin plugs Rating: 20 VA IP 24 Screwless live and neutral terminals For flush-mounting, back box to be min. 45 mm deep Supplied with 2 gang frame Cat.No 7 341 99 (3 mm thick) in case of extra wiring space needed			
1	7 342 90	<b>230 V / 120 V - 50/60 Hz</b> Nominal plate dimensions: 146 x 86 mm ● Antique Brass ● Brushed stainless steel			
1	7 346 90				

# Synergy™

## blanking plates, cord outlets and accessories - Flat plate



7 342 96



7 346 52

Terminal screws captive and backed off ready for cabling - large angled terminal entries. Compact mechanism for maximised wiring space  
Supplied with transparent protection cover and 4 fixing screws (2 long and 2 short screws)

Pack	Cat.Nos	Blanking plates
1	7 342 95	<b>1 gang</b> Nominal plate dimensions: 86 x 86 mm ● Antique Brass
1	7 346 95	● Brushed stainless steel
1	7 342 96	<b>2 gang</b> Nominal plate dimensions: 86 x 146 mm ● Antique Brass
1	7 346 96	● Brushed stainless steel
1	7 342 52	<b>Cord outlets</b> <b>1 gang</b> Nominal plate dimensions: 86 x 86 mm ● Antique Brass
1	7 346 52	● Brushed stainless steel
10	7 341 98	<b>Accessories</b> <b>Side extension frames</b> 3 mm thick frames to be used when extra wiring space is needed 1 gang frame
10	7 341 99	2 gang frame
1	7 341 90	<b>Screw extension kit</b> To be used when the installation depth of the flushmounting box is too big (i.e. walls with marble or ceramic finish) Kit comprising: - 20 pre-assembled rods-short - 2 threaded rods

# SYNERGY™

## Synergy™ Metalclad

A perfect flush fit with their surface mounting back boxes, the ideal solution for simple rugged performance

### DESIGNED TO TAKE THE ROUGH WITH THE SMOOTH

- All functions are available from switches to socket outlets or data sockets
- Available in grid modules for more complex installations cabling



Metalclad, p. 540



Grid system p. 542



Front plates: grey epoxy coated steel  
Terminal screws captive and backed off ready for cabling - large angled terminal entries  
Supplied complete with close fit 43 mm deep surface-mounting back box

Pack	Cat.Nos	Single pole plate switches 10 AX - 250 V~
5	7 338 00	Conform to BS EN 60669-1: 2000 Flush-mounting back box: min. 16 mm deep Nominal plate dimensions: 86 x 86 mm 1 gang - 1-way
5	7 338 01	1 gang - 2-way
5	7 338 05	1 gang - intermediate
5	7 338 02	2 gang - 2-way
5	7 338 03	3 gang - 2-way
Double pole switches 20 A - 250 V~		
5	7 338 10	Conform to BS EN 60669-1: 2000 Flush-mounting back box: min. 25 mm deep Nominal plate dimensions: 86 x 86 mm DP switch
5	7 338 16	DP switch with cord outlet + red LED power indicator
5	7 338 12	DP switch + red LED power indicator
Double pole switch 45 A - 250 V~		
5	7 338 21	Conforms to BS EN 60669-1: 2000 Red rocker Flush-mounting back box: min. 48 mm deep Nominal plate dimensions: 146 x 86 mm DP switch + red power indicator

Pack	Cat.Nos	Television sockets
5	7 338 40	Flush-mounting back box: min. 35 mm deep Nominal plate dimensions: 86 x 86 mm Screened TV - single, male
1	7 338 41	Screened satellite - single, "F" type
Telephone sockets		
5	7 338 50	Flush-mounting back box: min. 35 mm deep Nominal plate dimensions: 86 x 86 mm Single master
5	7 338 51	Single secondary
Data sockets Cat. 6		
1	7 338 56	Rapid cable connection Flush-mounting back box: min. 35 mm deep Nominal plate dimensions: 86 x 86 mm RJ 45 - single
1	7 338 57	RJ 45 - twin
Blanking plates		
5	7 338 95	1 gang Nominal plate dimensions: 86 x 86 mm
5	7 338 96	2 gang Nominal plate dimensions: 86 x 146 mm
Cable outlet 20 A - 250 V~		
5	7 338 19	Conforms to BS 5733: 1995 Flush-mounting back box: min. 25 mm deep Nominal plate dimensions: 86 x 86 mm 20 A - with terminal block and outlet gland

# Synergy™

## British standard socket outlets, RCD sockets and fused connection units - Metalclad



Front plates: grey epoxy coated steel  
Terminal screws captive and backed off ready for cabling - large angled terminal entries  
Supplied complete with close fit 43 mm deep surface-mounting back box

Pack	Cat.Nos	Socket outlets 13 A - 250 V~	Pack	Cat.Nos	RCD sockets 13 A - 250 V~
5	7 338 65	Conform to BS 1363 - Part 2: 1995 Patented 3 pin safety shutters mechanism 2 earth terminals Flush-mounting back box: min. 25 mm deep 1 gang - unswitched Nominal plate dimensions: 86 x 86 mm	1	7 338 97	Conform to BS 7288: 1990 and BS 1363 - Part 2: 1995 Maximum operating current 16 A Incorporate a "test and reset" button Flush-mounting back box: min. 25 mm deep RCD unit 2 gang DP 30 mA Nominal plate dimensions: 86 x 146 mm <b>Double pole switched</b> Active Electrical latching - trips on power failure
5	7 338 75	2 gang - unswitched Nominal plate dimensions: 86 x 146 mm	1	7 338 98	Passive Mechanical latching - does NOT trip on power failure
5	7 338 60	<b>Double pole socket outlets 13 A - 250 V~</b> Conform to BS 1363 - Part 2: 1995 Patented 3 pin safety shutters mechanism 2 earth terminals Flush-mounting back box: min. 25 mm deep <b>Switched</b> 1 gang Nominal plate dimensions: 86 x 86 mm	5	7 338 34	<b>Fused connection units 13 A - 250 V~</b> Conform to BS 1363 - Part 4: 1995 Fused 13 A (fuse supplied) Fuse drawer retained by quarter turn catch, drawer padlockable in open position for safety Flush-mounting back box: min. 25 mm deep Nominal plate dimensions: 86 x 86 mm <b>Double pole switched</b> Without cord outlet
5	7 338 70	2 gang Nominal plate dimensions: 86 x 146 mm	5	7 338 35	With red LED power indicator
5	7 338 61	<b>Switched with red LED power indicator</b> 1 gang Nominal plate dimensions: 86 x 86 mm	5	7 338 36	With cord outlet
5	7 338 71	2 gang Nominal plate dimensions: 86 x 146 mm	5	7 338 37	With cord outlet + red LED power indicator
5	7 338 88	<b>Socket outlets 15 A - 250 V~</b> Conform to BS 546: 1950 Patented 3 pin safety shutter mechanism Flush-mounting back box: min. 35 mm deep Nominal plate dimensions: 86 x 86 mm 1 gang - unswitched	5	7 338 30	<b>Unswitched</b> Without cord outlet
5	7 338 89	1 gang - switched	5	7 338 31	With red LED power indicator
			5	7 338 32	With cord outlet
			5	7 338 33	With cord outlet + red LED power indicator

GRID MODULES	ARCHITRAVES		FRONT PLATES WITH SMALL APERTURES			
	1 gang	2 gang	1 gang		2 gang	
	1 module	2 modules	1 module	2 modules	3 modules	4 modules
Dimensions (mm)	<b>86 x 36</b>	<b>146 x 36</b>	<b>86 x 86</b>	<b>86 x 86</b>	<b>86 x 146</b>	<b>86 x 146</b>
White	7 301 80	7 301 81	7 301 91	7 301 92	7 301 93	7 301 94
Traditional Brushed stainless steel	7 331 80	7 331 81	7 331 91	7 331 92	7 331 93	7 331 94
Traditional Polished stainless steel	7 333 80	7 333 81	7 333 91	7 333 92	7 333 93	7 333 94
Traditional Satin brass	7 335 80	7 335 81	7 335 91	7 335 92	7 335 93	7 335 94
Flat plate Antique Brass	-	-	7 343 91 <sup>(1)</sup>	7 343 92 <sup>(1)</sup>	7 343 93 <sup>(1)</sup>	7 343 94 <sup>(1)</sup>
Flat plate Brushed Stainless Steel	-	-	7 347 91 <sup>(1)</sup>	7 347 92 <sup>(1)</sup>	7 347 93 <sup>(1)</sup>	7 347 94 <sup>(1)</sup>
Metalclad	-	-	7 339 91	7 339 92	7 339 93	7 339 94
Dimensions (mm)	-	-	<b>89 x 89</b>	<b>89 x 89</b>	<b>89 x 149</b>	<b>89 x 149</b>
Modern Silver	-	-	7 311 91	7 311 92	7 311 93	7 311 94
Modern Nickel	-	-	7 313 91	7 313 92	7 313 93	7 313 94
<b>GRID YOKES</b>						
For White, Traditional and Metalclad	1 x 7 354 95	1 x 7 354 96	1 x 7 354 90	1 x 7 354 91	1 x 7 354 92	1 x 7 354 92
For Modern	-	-	1 x 7 354 81	1 x 7 354 81	1 x 7 354 82	1 x 7 354 82
<b>BOXES</b>						
Flush-mounting						
Flush-mounting with phase barriers						
Surface-mounting, steel with knockouts						
Surface-mounting, steel without knockouts						
Surface-mounting, metal with knockouts	-	-	7 364 00	7 364 00	7 364 01	7 364 01

Example of association:

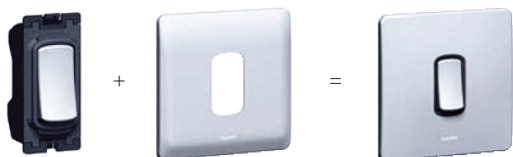

1: Yokes supplied with front plate



**FRONT PLATES WITH SMALL APERTURES**

2 x 2 gang		3 x 2 gang		3 x 3 gang	4 x 3 gang
6 modules	8 modules	9 modules	12 modules	18 modules	24 modules
<b>146 x 146</b>	<b>146 x 146</b>	<b>207 x 146</b>	<b>207 x 146</b>	<b>267 x 206</b>	<b>267 x 206</b>
7 301 82	7 301 83	7 301 84	7 301 85	7 301 86	7 301 87
7 331 82	7 331 83	7 331 84	7 331 85	7 331 86	7 331 87
7 333 82	7 333 83	7 333 84	7 333 85	7 333 86	7 333 87
7 335 82	7 335 83	7 335 84	7 335 85	7 335 86	7 335 87
7 343 82 <sup>(1)</sup>	7 343 83 <sup>(1)</sup>	-	-	-	-
7 347 82 <sup>(1)</sup>	7 347 83 <sup>(1)</sup>	-	-	-	-
7 339 82	7 339 83	7 339 84	7 339 85	7 339 86	7 339 87
<b>146 x 146</b>	<b>146 x 146</b>				
7 311 82	7 311 83	-	-	-	-
7 313 82	7 313 83	-	-	-	-
2 x 7 354 92	2 x 7 354 92	3 x 7 354 92	3 x 7 354 92	3 x 7 354 93	3 x 7 354 93
2 x 7 354 92	2 x 7 354 92	3 x 7 354 92	3 x 7 354 92	3 x 7 354 93	3 x 7 354 93
0 818 52	0 818 52	0 818 53	0 818 53	0 818 54	0 818 55
-	-	0 818 57	0 818 57	-	-
7 364 18	7 364 18	7 364 28	7 364 28	-	-
7 364 22	7 364 22	7 364 32	7 364 32	-	-

# Synergy™ Grid system total flexibility and choice

A vast selection of function modules, matching contoured rockers and a selection of rocker markings

## UNRIVALLED VERSATILITY WITHOUT COMPROMISING ON STYLE

- Contemporary metal plates with hidden screws
- Terminal screws captive and backed off ready for cabling



For grid modules p. 544



For Arteor mechanisms p. 360

## Synergy™

### Grid modules - decorative rockers



7 395 04



7 395 03



7 398 24



7 398 64



Front plate selection charts p. 542

Pack	Cat.Nos	Single pole switches 10 AX - 250 V~
		<b>1-way switch</b>
10	7 395 04	● Modern Silver
10	7 395 03	● Modern Nickel
1	7 398 24	● Flat plate Antique brass
1	7 398 64	● Flat plate Brushed Stainless Steel
		<b>2-way switch</b>
10	7 395 08	● Modern Silver
10	7 395 07	● Modern Nickel
1	7 398 28	● Flat plate Antique brass
1	7 398 68	● Flat plate Brushed Stainless Steel
		<b>Intermediate switch</b>
10	7 395 01	● Modern Silver
10	7 395 00	● Modern Nickel
1	7 398 21	● Flat plate Antique brass
1	7 398 61	● Flat plate Brushed Stainless Steel
		<b>Single pole switches 20 AX - 250 V~</b>
		<b>1-way switch</b>
10	7 396 79	● Modern Silver
10	7 396 80	● Modern Nickel
1	7 398 39	● Flat plate Antique brass
1	7 398 79	● Flat plate Brushed Stainless Steel
		<b>2-way switch</b>
10	7 396 83	● Modern Silver
10	7 396 82	● Modern Nickel
1	7 398 33	● Flat plate Antique brass
1	7 398 73	● Flat plate Brushed Stainless Steel
		<b>2-way retractive centre off switch</b>
10	7 396 92	● Modern Nickel
1	7 398 23	● Flat plate Antique brass
1	7 398 63	● Flat plate Brushed Stainless Steel

# Synergy™

## Grid modules - white and anthracite rockers without marking



Front plate selection charts **p. 542**

Pack	Cat.Nos		Single pole switches 10 AX - 250 V $\sim$
	White	Anthracite	Conform to BS EN 60669-1
10	7 354 00	7 355 00	1 way
10	7 354 01	7 355 01	1 way + neon
10	7 354 03	7 355 03	2 way
10	7 354 07	7 355 07	Intermediate
10	7 354 05	7 355 05	2-way push switch
10	7 354 06	7 355 06	2-way push switch marked "BELL"

Pack	Cat.Nos		Single pole switches 20 AX - 250 V $\sim$
	White	Anthracite	Conform to BS EN 60669-1
10	7 354 10	7 355 10	1 way
10	7 354 11	7 355 11	1 way + neon
10	7 354 12	7 355 12	2 way
10	7 354 18	7 355 18	Intermediate
10	7 354 13	7 355 13	2-way centre off
10	7 354 14	7 355 14	2-way retractive centre off
10	7 354 15	7 355 15	2-way push switch

Pack	Cat.Nos		Single pole key switches 20 AX - 250 V $\sim$
	White	Anthracite	Conform to BS EN 60669-1
10	7 354 16	7 355 16	Key supplied
10	7 354 17	7 355 17	2-way
10	7 354 17	7 355 17	2-way retractive centre off

Pack	Cat.Nos		Double pole switches 20 AX - 250 V $\sim$
	White	Anthracite	Conform to BS EN 60669-1
10	7 354 20	7 355 20	Switch
10	7 354 21	7 355 21	Switch + neon
10	7 354 22	7 355 22	Push to make
10	7 354 25	7 355 25	Push to break

Pack	Cat.Nos		Double pole key switches 20 AX - 250 V $\sim$
	White	Anthracite	Conform to BS EN 60669-1
10	7 354 23	7 355 23	Key supplied
10	7 354 24	7 355 24	Key switch
10	7 354 24	7 355 24	Key switch + neon

Pack	Cat.Nos		Dimmers 100 - 240 V $\sim$ - 50-60 Hz
	White	Anthracite	Conform to BS EN 60669-2-1
1	7 354 46	7 355 46	2-way - 300 W - push dimmer
1	7 354 48	7 355 48	2-way rotary dimmer - for 0-10 V ballasts - 400 W

Pack	Cat.Nos		Time delay switches
	White	Anthracite	
1	7 354 47	7 355 47	Time delay switch 300 W

Pack	Cat.Nos		Telephone sockets
	White	Anthracite	
1	7 354 50	7 355 50	BT master
1	7 354 51	7 355 51	BT secondary

Pack	Cat.Nos		Data sockets - Cat. 6
	White	Anthracite	
10	7 352 56	7 353 56	RJ 45 - 8 contacts

Pack	Cat.Nos		Television sockets
	White	Anthracite	
10	7 354 40	7 355 40	Screened TV single, male
10	7 354 41	7 355 41	Screened TV-SAT

Pack	Cat.Nos		Loudspeaker sockets
	White	Anthracite	
10	7 352 65	7 353 65	Hi-Fi loudspeaker socket

Pack	Cat.Nos		Fuse carriers 13 A - 250 V $\sim$
	White	Anthracite	
10	7 350 30	7 351 30	Fuse carrier

Pack	Cat.Nos		Accessories
	White	Anthracite	
10	7 350 62	7 351 62	Indicator - green neon
10	7 350 60	7 351 60	Indicator - red neon
20	7 354 36	7 355 36	Blanking plate

# WEATHERPROOF WIRING ACCESSORIES & OTHER INSTALLATION EQUIPMENT



**P. 548**  
Plexo IP 55  
complete  
flush-mounting

## Weatherproof wiring accessories & boxes



**P. 555**  
Plexo 66  
flush and surface-  
mounting



**P. 562**  
Plastic  
industrial  
boxes

## Installation equipment & connection



**P. 570**  
Colson  
cable  
ties

## Plugs and multi-outlet extensions



**NEW**  
**P. 574**  
Special plugs

## Door entry system & detection



**NEW**  
**P. 581**  
Chimes  
and bells

## NEW PRODUCTS 2014



**Special plugs**  
with sockets Double  
function,  
protected, and night light  
and with light sensitive  
sensor  
**(p. 574)**



**Multimedia  
multi-outlet extensions**  
with voltage surge protection  
**(p. 577)**



**P. 549**  
Plexo IP 55  
complete  
surface-  
mounting



**P. 550**  
Plexo IP 55  
mechanisms



**P. 553**  
Plexo IP 55  
boxes and  
support frames



**P. 554**  
Green'up Access  
sockets for electric  
vehicles



**P. 556**  
Soliroc  
IK 10



**P. 558**  
Plexo boxes



**P. 564**  
Flexible conduits



**P. 565**  
Flush-mounting  
boxes



**P. 568**  
Rigid conduits  
and fixing  
accessories



**P. 571**  
Duplix  
marking  
system



**P. 572**  
Nylbloc  
connection  
terminals and  
strips



**P. 573**  
Equipotential  
bonding  
connectors



**P. 574**  
British  
and German  
standard  
plugs, travel  
adaptors



**NEW**  
**P. 577**  
Multi-outlet  
extensions for  
multimedia



**P. 579**  
Cable reels  
and inspection  
lamps



**NEW**  
**P. 580**  
Shaverlights  
and lighting  
equipment



**NEW**  
**P. 582**  
Colour video  
door entry kits



**P. 584**  
Audio door  
entry kits



**P. 586**  
Movement  
detectors and  
door contact



**NEW**  
**P. 587**  
Technical alarm  
detectors



**Colour video  
door entry kits**  
7" and 3.5" colour  
video kits - 2 wires  
(p. 582)



**Technical alarm  
detectors**  
for domestic premises  
(p. 587)



Mechanisms supplied complete

Pack	Cat.Nos	Switches 10 AX - 250 V~	Socket outlets 20 A
10	0 698 51	IP 55 - IK 07 Automatic terminals <b>1 gang two-way switch</b> ○ White ● Grey	IP 44 - IK 08 Screw terminals <b>2P+E - 230 V~</b> ● Grey
10	0 698 11		
5	0 698 55	<b>2 gang two-way switch</b> ○ White	<b>3P+E - 400 V~</b> ● Grey
5	0 698 61	<b>Push-buttons 10 A - 250 V~</b> IP 55 - IK 07 Automatic terminals <b>Illuminated changeover push-button</b> (N/O + N/C contact) Supplied with 230 V~ lamp ○ White ● Grey	<b>3P+N+E - 400 V~</b> ● Grey
10	0 698 21		
5	0 698 64	<b>Illuminated changeover push-button with label-holder</b> (N/O + N/C contact) Supplied with 12 V lamp Can be equipped with 230 V~ lamp ○ White ● Grey	<b>Surface-mounting box</b> Surface-mounting box for 20 A sockets Cat.Nos 0 557 03/06/08 Dimensions: 79 x 86 x 40 mm
5	0 698 24		
10	0 698 69	<b>German standard socket outlets 16 A - 250 V~</b> IP 55 - IK 07 Screw terminals <b>2P+E with earth lateral contacts</b> ○ White ● Grey	
10	0 698 33		
5	0 707 72		○ White antimicrobial
5	0 707 73	<b>2P+E with earth lateral contacts, with claws</b> ○ White antimicrobial	
10	0 698 70	<b>French standard socket outlets 16 A - 250 V~</b> IP 55 - IK 07 Automatic terminals <b>2P + E with shutters for child protection</b> ○ White ● Grey	
10	0 698 31		

Rigid conduits, p. 568



Video installation of Plexo



# Plexo™

## complete surface-mounting IP 55



### Pack Cat.Nos Switches 10 AX - 250 V~

Pack	Cat.Nos	Description
10	0 697 11	IP 55 – IK 07 Automatic terminals ● Grey Two-way switch
5	0 697 16	Intermediate switch
10	0 697 12	Two-way switch with indicator Supplied with 230 V~ lamp
5	0 697 13	Illuminated two-way switch Supplied with 230 V~ lamp
10	0 697 15	Two-gang two-way switch
1	0 697 17	Double pole switch

### Push-buttons 10 A

Pack	Cat.Nos	Description
10	0 697 20	IP 55 – IK 07 Automatic terminals ● Grey N/O contact
10	0 697 22	Illuminated N/O contact Supplied with 230 V~ lamp

### Movement detectors

Pack	Cat.Nos	Description
1	0 697 80	IP 55 - IK 04 Automatic terminals Allows control of a lighting device as soon as the movement is detected Maximum load: - 2000 W for incandescent and halogen lamps 230 V~ and - 2000 W for ELV halogen lamps, - 1000 VA for fluorescent tubes and compact fluorescent lamps Detection range from 0 to 12 m Detection angle : 360° Coverage pattern adjustable during installation process Temporization between 12 s and 16 min. Dim. 90x90x85 mm
1	0 697 40	○ White ● Grey

### Pack Cat.Nos Socket outlets

Pack	Cat.Nos	Description
10	0 697 33	● Grey <b>German standard 16 A – 250 V~</b> 2P+E with earth lateral contact screw terminals
10	0 697 32	<b>British standard 13 A – 250 V~</b> 2P+E with screw terminals
5	0 697 39	2 x 2P+E screw terminals
5	0 697 50	2P+E unswitched + switch screw terminals
10	0 697 31	<b>French standard 16 A – 250 V~</b> 2P+E with shutters for child protection, automatic terminals

### Socket outlets 20 and 32 A

Pack	Cat.Nos	Description
5	0 916 55	Screw terminals ● Grey <b>20 A - IP 55 - IK 08</b> Compatible with membrane glands Cat.No 0 919 14 2P+E - 230 V~
5	0 916 56	3P+E - 230 V~
5	0 916 57	3P+N+E - 230 V~
5	0 558 72	<b>32 A - IP 44 - IK 08</b> Compatible with membrane glands Cat.No 0 919 15 2P+E - 230 V~
5	0 558 75	3P+E - 230 V~
5	0 558 77	3P+N+E - 230 V~

### Membrane glands

50	0 919 14	Grey (RAL 7035)
50	0 919 15	Grey (RAL 7035)

# Plexo™ mechanisms

## switches, push-buttons and automatic switches IP 55



Mechanisms supplied with cover plate  
 Installation with surface-mounting boxes or flush-mounting support frames (p. 553)  
 Automatic terminals

### Pack Cat.Nos Switches 10 AX - 250 V~

Pack	Cat.Nos	IP 55 - IK 07
10	0 696 11	<b>Two-way switch</b> ○ White ● Grey ○ White antimicrobial
10	0 695 11	
5	0 707 11	
5	0 696 12	<b>Two-way switch with indicator</b> Supplied with 230 V~ lamp ○ White ● Grey
10	0 695 12	
5	0 696 13	<b>Illuminated two-way switch</b> Supplied with 230 V~ lamp ○ White ● Grey
5	0 695 13	
10	0 695 25	<b>2 gang two-way switch</b> ● Grey ○ White antimicrobial
5	0 707 26	
10	0 695 30	<b>Double pole switch</b> ● Grey ○ White antimicrobial
5	0 707 27	

### Switches 16 A - 250 V~

Pack	Cat.Nos	IP 55 - IK 07
5	0 695 23	<b>Two-way switch</b> ● Grey
1	0 695 24	<b>Illuminated two-way switch</b> Supplied with 230 V~ lamp ● Grey
1	0 695 27	<b>Double pole switch</b> ● Grey
1	0 695 28	<b>Double pole switch with indicator</b> Supplied with 230 V~ lamp ● Grey

### Pack Cat.Nos Push-buttons 10 A

Pack	Cat.Nos	IP 55 - IK 07
10	0 695 40	<b>N/O contact</b> ● Grey ○ White antimicrobial
5	0 707 30	
10	0 695 42	<b>Illuminated N/O contact</b> Supplied with 230 V~ lamp ● Grey ○ White antimicrobial
5	0 707 32	
5	0 707 33	<b>Illuminated - N/O contact with label-holder</b> Supplied with 12 V lamp ○ White antimicrobial

### Automatic switches 230 V~

Pack	Cat.Nos	IP 55 - IK 07
1	0 695 00	Maximum detection range: 8 m (adjustable) <b>Without neutral - 2-wire connection</b> Can be used instead of a 1 way switch No additional wiring required Operates: 60 to 300 W incandescent and halogen lamps 230 V~ Temporization: 6 s to 6 min. Detection angle: 130° Luminosity threshold: 3 to 1000 lux ● Grey/White
1	0 695 02	<b>With neutral - 3-wire connection</b> Operates: - 500 to 1000 W incandescent and halogen lamps 230 V~ - ELV halogen lamps - compact fluorescent lamps Temporization: 1 s to 16 min. Detection angle: 180° Luminosity threshold: 3 to 1000 lux ● Grey/White



# Plexo™ mechanisms

## controls and socket outlets IP 55



Mechanisms supplied with cover plate  
Installation with surface-mounting boxes or flush-mounting support frames (p. 553)

Pack	Cat.Nos	Light sensitive switches, 230 V~	Pack	Cat.Nos	Illuminated time lag switches - 250 V~
5	0 695 17	<b>Light sensitive switch 1 function</b> Can be used to switch a lighting circuit "ON" and "OFF" based on light conditions (nightfall, daybreak) Supplied in one piece, including photoelectric cell Maximum load: - 1400 W incandescent and halogen lamps 230 V~ - 400 VA fluorescent tubes Luminosity threshold: 0,5 to 1500 lux IP 55 - IK 07 <ul style="list-style-type: none"> <li>● Grey</li> </ul>	5	0 696 04 0 695 04	<b>Electronic time lag switch - IP 55</b> 2-wire connection Supplied with lamp Temporization: 25 s to 15 min. Maximum loads: - 1000 W incandescent and halogen 230 V~ - 400 W halogen 130 V - 400 VA ELV halogen lamps - 400 VA fluorescent lamps - 2300 W resistive (heating) <ul style="list-style-type: none"> <li>○ White</li> <li>● Grey</li> </ul>
5	0 695 18	<b>Photoelectric cell</b> For use with modular light sensitive switches IP 55 <ul style="list-style-type: none"> <li>● Grey</li> </ul>	10	0 696 39 0 695 71 0 707 22	<b>German standard socket outlets 16 A - 250 V~</b> With earth lateral contact <b>2P+E screw terminals</b> <ul style="list-style-type: none"> <li>○ White</li> <li>● Grey</li> <li>○ White antimicrobial</li> </ul>
1	0 695 34	<b>Key-operated switches 3 A - 250 V~</b> Supplied with RONIS key n° 455 Key removable in all position 2 N/O contacts <b>2 positions marked "0 - I"</b> <ul style="list-style-type: none"> <li>● Grey</li> </ul>	5	0 696 40 0 695 70	<b>2P+E automatic terminals</b> <ul style="list-style-type: none"> <li>○ White</li> <li>● Grey</li> </ul>
1	0 695 35	<b>3 positions marked "I - 0 - II"</b> <ul style="list-style-type: none"> <li>● Grey</li> </ul>	10	0 695 85	<b>British standard socket outlet 13 A - 250 V~</b> <b>2P+E screw terminals</b> <ul style="list-style-type: none"> <li>● Grey</li> </ul>
1	0 695 47	<b>Emergency stop functions 3 A - 250 V~</b> Supplied with "emergency stop" label in 8 languages. Yellow cover plate, red button <b>Emergency stop button - 1 N/C contact</b> <ul style="list-style-type: none"> <li>● Grey/yellow</li> </ul>	10	0 696 21 0 695 51 0 707 21	<b>French standard socket outlets 16 A - 250 V~</b> <b>2P+E automatic terminals</b> With shutters for child protection <ul style="list-style-type: none"> <li>○ White</li> <li>● Grey</li> <li>○ White antimicrobial</li> </ul>
1	0 695 48	<b>Emergency stop with key for reset - N/O + N/C contact</b> Key RONIS n° 455 supplied Key removable in 0 position <ul style="list-style-type: none"> <li>● Grey/yellow</li> </ul>	5	0 695 53	<b>2P+E tamperproof-screw terminals</b> <ul style="list-style-type: none"> <li>● Grey</li> </ul>
1	0 695 49	<b>Emergency stop - stay put 1/4 release - N/O + N/C contact</b> Key removable in 0 position <ul style="list-style-type: none"> <li>● Grey/yellow</li> </ul>	5	0 695 55	<b>2P+E with flap-automatic terminals</b> Automatic opening of the flap <ul style="list-style-type: none"> <li>● Grey</li> </ul>
			10	0 502 99	<b>Tamperproof insert for Cat.No 0 695 53</b> <ul style="list-style-type: none"> <li>● Tamperproof insert for socket</li> <li>● Fits directly into the plug</li> </ul>

Green'Up Access socket outlets for electric vehicles, p. 554



# Plexo™ mechanisms

prewired socket outlets, data, TV sockets and adaptors - IP 55



Mechanisms supplied with cover plate  
Installation with surface-mounting boxes or flush-mounting support frames (p. 553)

Pack	Cat.Nos	<b>Prewired German standard socket outlets 16 A - 250 V~</b>
5	0 695 76	Automatic terminals One piece mechanism, only one connection required For two or three gang surface-mounting boxes or flush-mounting supports <b>2 x 2P+E horizontal</b> ● Grey
5	0 695 77	<b>2 x 2P+E vertical</b> ● Grey

Pack	Cat.Nos	<b>RJ 45 data sockets</b>
5	0 695 69	IP 55 with closed shutter IK 07 <b>Cat. 6 FTP</b> ● Grey
1	0 695 61	<b>Cat. 6 UTP</b> ● Grey
1	0 695 57	<b>Cat. 5e FTP</b> ● Grey
1	0 695 56	<b>Cat. 5e UTP</b> ● Grey

Pack	Cat.Nos	<b>TV-R-SAT sockets</b>
1	0 707 24	For terrestrial and satellite installation with individual demodulator For receiving analogue and digital programmes (DTT, satellite channels, etc) Fitted with an automatic connection terminal for connection of the coaxial cable ○ White antimicrobial

Pack	Cat.Nos	<b>Adaptors for 2-module Arteor/Mosaic mechanisms</b>
10	0 695 80	Can be equipped with any 2-module Arteor functions (except specific mechanisms with depth > 18 mm) in order to obtain an IP 55 wiring device <b>Adaptor with smoked polycarbonate flap</b> ○ Grey/white
1	0 695 79	<b>Adaptor with smoked polycarbonate flap lockable</b> Lockable with special tool Cat.No 0 919 45 ○ Grey/white
1	0 695 82	<b>Adaptor without flap - IP 20</b> ○ Grey/white

Pack	Cat.Nos	<b>Adaptors for 3-module Arteor/Mosaic mechanisms</b>
1	6 806 33	Weatherproof IP 55 with membrane Allows operations of switches without opening cover maintaining IP 55 rating ● Grey ○ White
1	6 806 32	
1	0 919 45	<b>Accessories</b> Special tool for adaptor Cat.No 0 695 79
100	0 849 00	Standard claws
50	0 849 01	

# Plexo™

## surface-mounting boxes and support frames IP 55



To be equipped with modular Plexo mechanisms (p. 550-552)

Pack	Cat.Nos	Surface-mounting boxes with membrane glands
		Equipped with removable membrane glands Direct entry of cables (no need to be cut)
		<b>1 gang - 1 entry</b>
10	0 696 89	○ White
10	0 696 51	● Grey
10	0 707 41	○ White antimicrobial
		<b>2 gang - 2 entries</b>
		No separation between compartments, in order to facilitate the cabling operations and to allow the installation of pre-wired socket outlets
5	0 696 90	○ White - horizontal mounting
5	0 696 72	● Grey - horizontal mounting
1	0 707 42	○ White antimicrobial - horizontal mounting
5	0 696 91	○ White - vertical mounting
5	0 696 61	● Grey - vertical mounting
1	0 707 43	○ White antimicrobial - vertical mounting

Pack	Cat.Nos	Surface-mounting boxes for cable glands
		<b>1 gang - 1 entry</b>
5	0 696 56	● Grey
		<b>2 gang - 2 entries (2 top)</b>
5	0 696 78	● Grey - horizontal mounting
5	0 696 68	● Grey - vertical mounting

Pack	Cat.Nos	Flush-mounting support frames
		Used for flush-mounting version for German and French standard boxes only
		<b>1 gang</b>
		Can be equipped with claws Cat.Nos 0 849 00/01
10	0 696 92	○ White
10	0 696 81	● Grey
10	0 707 92	○ White antimicrobial
		<b>2 gang - 2 entries</b>
		71 mm fixing centres
5	0 696 94	○ White - horizontal mounting
5	0 696 83	● Grey - horizontal mounting
1	0 707 94	○ White antimicrobial - horizontal mounting
5	0 696 96	○ White - vertical mounting
5	0 696 85	● Grey - vertical mounting
1	0 707 49	○ White antimicrobial - vertical mounting

Flush-mounting boxes for all ranges and standards, **p. 565**





Absolute **safety,**  
**today**









■ CHARGING SOCKETS AND TERMINALS FOR ELECTRIC VEHICLES

The Green'Up Access 2P+E socket with safety shutters charges your vehicle safely in mode 1 and mode 2 safer than with a conventional socket



Used for safely charging rechargeable electric and hybrid vehicles which take mode 2 cord (compatible with mode 1)  
Connected to the consumer panel via one 3 x 2.5 mm<sup>2</sup> dedicated line (1 line per socket) protected by 30 mA - 20 A C curve, type A or HPI RCBO (or 30 mA type A or HPI RCCB + 20 A C curve circuit breaker)  
Recommended installation height: 1.30 m from the ground  
Suitable for residential and workplace use

Pack	Cat.Nos	Mode 1 and mode 2 sockets - 3.2 kVA
		Heavy-duty mechanisms with silvered contacts Single-phase sockets - screw connection - 230 V Supplied with base Cat.No 0 904 78 for hanging up the vehicle charging cable control box For charging 1 vehicle Conform to IEC 60-884-1
		<b>IP 66 - IK 08 surface-mounting</b> Suitable for installation in private houses Plastic socket with flap cover Supplied complete with surface mounting box fitted with an ISO 20 cable gland Dimensions (H x W x D): 98 x 98 x 70 mm (exc. cable gland)
1	0 904 72	 German standard socket outlet  British standard socket outlet  French standard socket outlet
1	0 904 73	
1	0 904 71	
		<b>IP 55 - IK 10 flush-mounting - metal socket</b> Suitable for installation in private houses, lock-up garages, parking lots, etc Supplied complete with plate and support Mounting in 1-gang Batibox flush-mounting box depth 50 mm Can be surface mounted with box Cat.No 0 778 90 Dimensions (H x W x D): 110 x 110 x 13.5 mm
1	<b>N</b> 0 778 97	 French standard socket outlet  German standard socket outlet
1	0 778 56	
		<b>IP 55 - IK 10 flush-mounting - metal socket with locked flap cover</b> Suitable for installation in private houses, lock-up garages, parking lots, etc Supplied complete with plate and support Mounting in 1-gang Batibox flush-mounting box depth 50 mm Can be surface mounted with box Cat.No 0 778 90 Dimensions (H x W x D): 110 x 110 x 13.5 mm Supplied complete with a unique set of 2 keys in order to restrict access to the socket
1	<b>N</b> 0 778 98	 French standard socket outlet  German standard socket outlet
1	0 778 57	
1	0 904 78	<b>Base</b> For hanging up the vehicle charging cable control box Plastic

## Plexo™ 66 complete flush-mounting

IP 66 - IK 08



White RAL 9010  
 Polypropylene/ABS housing  
 Temperature rating: - 20 to + 40 °C (+ 50 °C for short periods)  
 Supplied without back boxes, can mount directly on to standard metal flush boxes  
 Stainless steel captive terminal screws supplied in backed-off position  
 Supplied with flush-mounting gasket  
 Supplied without lamps

Pack	Cat.Nos	20 A - 250 V~ switches
1	6 845 53	Conform to BS EN 60669-1 Flush-mounting gasket is not required when fitting these mechanisms on to back boxes Cat.Nos 6 845 89/90/91 1 gang 2 way switch - SP
1	6 845 54	2 gang 2 way SP
1	6 845 56	1 gang 1 way DP + indicator
1	6 845 60	<b>6 A - 250 V~ push-button</b> 1 gang 2 way SP retractive switch
1	6 845 70	<b>13 A - 250 V~ socket outlet</b> Conforms to BS 1363 : Part 2 1 gang unswitched
1	6 845 85	<b>Arteor/Mosaic adaptor</b> 2 modules with opaque lid

## Plexo™ 66 complete surface-mounting

IP 66 - IK 08



Grey RAL 7016/TO 29  
 Supplied with ISO 20 membrane glands and caps (for rear cabling)  
 Stainless steel captive terminal screws supplied in backed-off position

Pack	Cat.Nos	20 A - 250 V~ switches
1	6 846 03	Conform to BS EN 60669-1 Fitted with rear gasket with groove to deposit silicone 1 gang
1	6 846 02	Two-way switch - SP 1 gang
1	6 846 04	One way switch - DP 2 gang Two-way switch - SP
1	6 846 11	<b>6 A - 250 V~ push-buttons</b> 1 gang Two-way switch - SP with "Bell"
1	6 846 45	<b>13 A - 250 V~ fused spur unit</b> Conform to BS 1363: Part 4 Fitted with rear gasket with groove to deposit silicone 1 gang - DP switched
1	6 846 22	<b>13 A - 250 V~ socket outlets</b> Conform to BS 1363: Part 2 Fitted with rear gasket with groove to deposit silicone 1 gang Switched socket with opaque lid
1	6 846 20	1 gang Unswitched socket with opaque lid
1	6 846 19	1 gang unswitched Accepts moulded plugs with side outlet
1	6 846 28	2 gang unswitched
1	0 904 67	<b>RJ 45 socket</b> Cat.6 - FTP
1	6 846 36	<b>Arteor/Mosaic adaptors</b> 2 module adaptor - semi-transparent lid
1	6 846 38	3 module adaptor - semi-transparent lid



0 778 11



0 778 25



0 778 74

Suitable for public buildings, unsupervised passageways, car parks, communal areas in buildings

High resistance to IK 10 impacts and humidity

4 fixing points by plugging the plate directly on the wall and 4 blanking plates to be force-mounted on the plate (can only be removed by drilling)

Mechanisms supplied with cover plates, to be equipped with support frames (p. 808) and plates (p. 557)

Pack	Cat.Nos	Switches 10 AX - 250 V~	Pack	Cat.Nos	Time-delayed switch - IK 10 - IP 55
1	0 778 11	2-way switch	1	0 778 23	Without neutral, 2-wire - 1000 W
1	0 778 21	Intermediate switch			For controlling 1000 W incandescent and halogen lighting 230 V~, 400 VA ELV halogen fluo lighting
1	0 778 12	Illuminated 2-way switch Supplied with lamp Cat.No 0 676 66			For controlling a motor (eg: Ventilation) - 250 VA Time delay from 25 s to 15 mins
1	0 778 14	2-way indicator switch Supplied with lamp Cat.No 0 676 68			<b>Keyswitches - IK 10 - IP 54</b>
1	0 778 13	2-way switch with label holder	1	0 778 74	2-position keyswitch 2 NO contacts - 6 A - 230 V Key can be removed in either position
1	0 778 22	Double pole switch 20 A	1	0 778 75	3-position key-operated push-button Changeover switch with off position - 6 A - 230 V Key can be removed in off position
		<b>Automatic switches - IK 10 - IP 55</b>			<b>Outdoor flush-mounting readers - IK 10 - IP 55</b>
		Infrared detection Detection range adjustable from 3 m to 8 m Horizontal detection angle: 130° Light level threshold adjustable from 3 to 1000 lux Time delay adjustable from 1 s to 16 mins with repetition of cycle as long as movement is detected Remote manual control possible with normally closed push-button Integrated self-protection against overloads and short-circuits Should preferably be installed in box depth 50 mm			Power supply 12/24 V <sub>±</sub> / ~
1	0 778 25	<b>With neutral, 3-wire 1000 W</b> For controlling lamps: - Up to 1000 W, incandescent and halogen 230 V~ - Up to 500 VA, ELV halogen via ferromagnetic or electronic transformer - Fluo 500 VA Can control a ventilation appliance (100 VA max.)	1	0 778 72	<b>Stand-alone badge reader</b> 1 relay output for door release or electromagnetic lock 1 push-button input for internal unlocking Up to 500 users
1	0 778 27	<b>Without neutral, 2-wire 400 W</b> Can be installed as a replacement for a conventional switch without additional wiring For controlling lamps: 40 W min. to 400 W max. incandescent, halogen 230 V~ or ELV halogen with ferromagnetic or electronic transformer	1	0 778 76	<b>Backlit coded keypad</b> Consumption: 75 mA at 12 V <sub>±</sub> 1 relay output for door release or electromagnetic lock 1 push-button input for internal unlocking Up to 99 users
		<b>Push-buttons 6 A - 230 V~ - IK 10 - IP 55</b>	1	0 778 78	<b>Backlit coded keypad with push-button</b> Consumption: 75 mA at 12 V <sub>±</sub> 1 relay output for door release or electromagnetic lock 1 push-button input for internal unlocking 1 push-button on the front panel for call, chime or door opening. Up to 99 users
1	0 778 41	Two-way push-button NO-NC contact	1	0 778 68	<b>Illuminated sign 230 V~ - IK 10 - IP 55</b> Mechanism incorporating white LEDs and a pivoting window which can take preprinted labels 2 choices of power rating (0.2 W or 1 W)
1	0 778 42	Illuminated two-way push-button NO contact Supplied with lamp Cat.No 0 676 66			<b>Passage lighting - IK 10 - IP 55</b>
1	0 778 44	Two-way push-button + indicator light NO contact with potential free terminal Supplied with lamp Cat.No 0 676 68	1	0 778 67	For lighting a staircase, etc 250 V~ Supplied complete with: - Soliroc plate 5 modules - 1 set of 4 blanking plates that can be removed by drilling Mechanism: screw fixing in flush-mounting boxes, depth 40 mm Supplied with: - 16 white LEDs (2 W) - 1 x 5 modules Batibox support
1	0 778 43	Two-way push-button with label-holder NO-NC contact			

Support frames, p. 808



# Soliroc™

## sockets and mounting accessories IK 10



0 778 31



0 778 91



0 778 51



0 778 90

Suitable for public buildings, unsupervised passageways, car parks, communal areas in buildings

High resistance to IK 10 impacts and humidity

4 fixing points by plugging the plate directly on the wall and 4 blanking plates to be force-mounted on the plate (can only be removed by drilling)

Mechanisms supplied complete with cover plates

Pack	Cat.Nos	Socket outlets - IK 10	Pack	Cat.Nos	Plates - IK 10
1	0 778 35	<b>German standard 16 A - 250 V</b> 2P+E with safety shutters, screw terminals and cover IP 55	1	0 778 51	1-gang plate 110 x 110 mm
1	0 778 36	2P+E with safety shutters, screw terminals, no cover IP 20	1	0 778 52	2-gang plate 110 x 181 mm Horizontal or vertical mounting 71 mm fixing centres
1	0 778 37	2P+E with safety shutters, screw terminals and locked cover IP 55	1	0 778 53	3-gang plate 110 x 252 mm Horizontal or vertical mounting 71 mm fixing centres
1	0 778 31	<b>French standard 16 A - 250 V</b> 2P+E with automatic terminals and cover IP 55			<b>Surface-mounting boxes</b> Cannot be used for Cat.Nos 0 778 74/75 Supplied with 4 blanking plugs Take ISO 20 protective conductors
1	0 778 33	2P+E with automatic terminals and locked cover IP 55	1	0 778 90	1-gang 110 x 110 x 45 mm
1	0 778 32	2P+E with automatic terminals, no cover IP 20	1	0 778 92	2-gang 110 x 181 x 45 mm Horizontal or vertical mounting 71 mm fixing centres
1	0 778 82	<b>TV socket - IK 10 - IP 20</b> Male TV socket 0-2400 MHz			<b>Accessories</b>
1	0 778 91	<b>RJ 45 socket - IK 10 - IP 20</b> Cat. 6 - FTP	1	0 778 84	<b>Adaptors for Arteor/Mosaic functions</b> Take 2-module Arteor/Mosaic mechanisms (except special surface-mounting type)
1	0 778 50	<b>Cable outlet - IK 10 - IP 55</b> Supplied with cable grip	1	0 778 80	Adaptor with lockable cover - IP 55 - IK 10
			1	0 778 81	Adaptor with cover - IP 55 - IK 10
			1	0 778 81	Adaptor without cover - IP 20
			5	0 778 96	<b>Replacement blanking plugs</b> Can only be removed by drilling Set of 4
			1	0 778 85	<b>Seals for surface correction</b> Made of foam to compensate for unevenness of the wall
			1	0 778 86	For 1-gang plate
			1	0 778 87	For 2-gang plate
			1	0 778 87	For 3-gang plate
			1	0 778 66	<b>Blanking plate</b> 2 modules
			1	0 778 83	<b>Fixing accessory</b> Fits on Batibox boxes for masonry and concrete, for fixing directly in the wall The Soliroc plate can be fixed onto this accessory with no need for drilling or using plugs in the wall 1-gang, can be joined to create 2-gang

Green'Up Access socket outlets for electric vehicles, p. 554



## Plexo™ boxes IP 55 - IK 07

with direct entry membrane glands - 650 °C

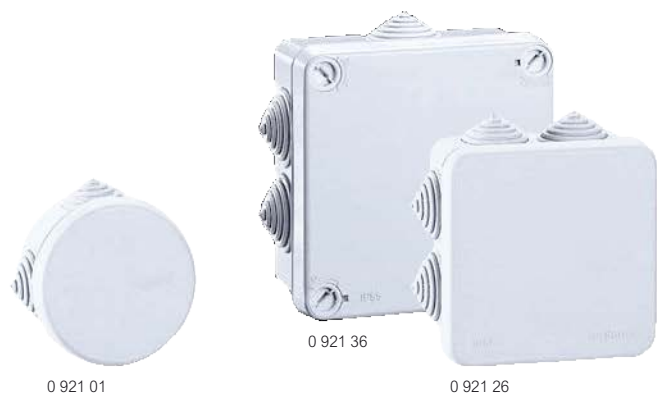

Dimensions p. 560  
 Technical characteristics p. 561

Resistance to glow wire test: 650 °C (EN 60695 2-1)  
 Operating temperature: - 25 °C to + 40 °C  
 Interchangeable membrane glands with direct entry  
 Material: polystyrene box and polypropylene cover  
 Opaque cover  
 Membrane gland or pre-cut knock-out for ISO type cable gland

Pack	Cat.Nos	Standard boxes
		Grey RAL 7035 With fixing slots for easy alignment Use 5 mm Ø screws Alternatively use wall fixing Cat.No 0 319 57 Clip-on cover
5/100	0 921 00	<b>Ø60 mm x 40 mm</b> 4 glands (Cat.No 0 919 10)
5/100	0 921 01	<b>Ø70 mm x 40 mm</b> 4 glands (Cat.No 0 919 10)
5/100	0 921 04	<b>65 x 65 x 40 mm</b> 7 glands (Cat.No 0 919 10)
		<b>Class II boxes</b>
		Grey RAL 7035 Mounting by: - either internal fixing points - use 5 mm Ø screws - or at three corners outside the wiring area - use 4 mm Ø screws Provision for anti-tamper seal Cover with 4 x 1/4 turn fixings, indicated I-O, can be retained open during installation
5/100	0 921 26	<b>80 x 80 x 45 mm</b> 7 glands (Cat.No 0 919 10)
5/50	0 921 27	With pre-cut knock-outs
5/50	0 921 36	<b>105 x 105 x 55 mm</b> 7 glands (Cat.No 0 919 11)
5/30	0 921 37	With pre-cut knock-outs
		<b>Accessories</b>
20	0 312 10	Strip with four 4 mm <sup>2</sup> terminal for junctions For fitting in Plexo boxes Cat.Nos 0 921 00/01, 0 921 04/26/27

## Plexo™ boxes IP 55 - IK 07

with direct entry membrane glands - 750 °C



Dimensions p. 560  
 Technical characteristics p. 561

Resistance to glow wire test: 750 °C (EN 60695 2-1)  
 Operating temperature: - 25 °C to + 40 °C  
 Interchangeable membrane glands with direct entry  
 Captive cover with clippable tie between box and cover except boxes 310 x 240 and 360 x 270  
 Cover opens/closes with a 1/4 turn of a regular screwdriver, marking 0 and I  
 Class II is ensured by protection caps (supplied) for the attachment screws

Pack	Cat.Nos	Square boxes
		Grey RAL 7035
1	0 920 32	<b>130 x 130 x 74 mm</b> 10 glands Ø cables and tubes accepted 4 to 25 mm
		<b>Rectangular boxes</b>
		Grey RAL 7035
20	0 920 42	<b>155 x 155 x 74 mm</b> 10 glands Ø cables and tubes accepted 4 to 25 mm
1/10	0 920 52	<b>180 x 140 x 86 mm</b> 10 glands Ø cables and tubes accepted 4 to 32 mm
1/10	0 920 62	<b>220 x 170 x 86 mm</b> 14 glands Ø cables and tubes accepted 4 to 32 mm
1/2	0 920 82	<b>310 x 240 x 124 mm</b> 24 glands Ø cables and tubes accepted 4 to 40 mm
1	0 920 92	<b>360 x 270 x 124 mm</b> 24 glands Ø cables and tubes accepted 4 to 40 mm



## Plexo™ boxes IP 55 - IK 07

with pre-cut knock-out ISO type cable entries



Dimensions **p. 560**  
 Technical characteristics **p. 561**

Resistance to glow wire test: 750 °C (EN 60695 2-1)

Operating temperature: - 25 °C to + 40 °C

Knock-out entries

Captive cover with clippable tie between box and cover except boxes 310 x 240 and 360 x 270

Cover opens/closes with a 1/4 turn of a regular screwdriver, marking 0 and I

Fixing with level adjustment

- At 2 or 4 internal points (screw Ø5 mm max.)
- At the four corners out of wiring volume (screw Ø4 mm max.)
- With brackets Cat.No 0 358 02

Class II is ensured by protection caps (supplied) for the attachment screws

Pack	Cat.Nos	Square boxes
1/10	0 920 34	Grey RAL 7035 <b>130 x 130 x 74 mm</b> 16 knock-out entries for ISO 12/16 4 knock-out entries for ISO 20/25
1/10	0 920 44	Grey RAL 7035 <b>155 x 110 x 74 mm</b> 16 knock-out entries for ISO 12/16 4 knock-out entries for ISO 20/25
1/5	0 920 54	Grey RAL 7035 <b>180 x 140 x 86 mm</b> 16 knock-out entries for ISO 16/20 4 knock-out entries for ISO 20/25
1/5	0 920 64	Grey RAL 7035 <b>220 x 170 x 86 mm</b> 12 knock-out entries for ISO 16/20 8 knock-out entries for ISO 20/25 4 knock-out entries for ISO 25/32
1/2	0 920 84	Grey RAL 7035 <b>310 x 240 x 124 mm</b> 2 knock-out entries for ISO 16/20 22 knock-out entries for ISO 20/25 6 knock-out entries for ISO 25/32 6 knock-out entries for ISO 32/40
1	0 920 94	Grey RAL 7035 <b>360 x 270 x 124 mm</b> 2 knock-out entries for ISO 16/20 18 knock-out entries for ISO 20/25 10 knock-out entries for ISO 25/32 6 knock-out entries for ISO 32/40

## Plexo™ boxes

accessories



Pack	Cat.Nos	Direct entry membrane glands
50	0 919 14	With marking of Ø for tubes and cables Direct entry for tubes (up to 16 mm) and cables <b>Up to Ø20</b> Grey (RAL 7035)
50	0 919 15	<b>Up to Ø25</b> Grey (RAL 7035)
50	0 919 16	<b>Up to Ø32</b> Grey (RAL 7035)
50	0 919 17	<b>Up to Ø40</b> Grey (RAL 7035)
50	0 919 10	<b>Membrane glands</b> Grey (RAL 7035) With marking of Ø for tubes and cables Up to Ø20
50	0 919 11	Up to Ø25
1	0 358 02	<b>Fixing accessories</b> <b>Set of 4 lugs</b> For wall fixing supplied with screws
1	0 358 00	<b>Equipment accessories</b> <b>Set of 2 hinges (RAL 7016)</b> For boxes 130 x 130 mm up to 220 x 170 mm included
1	0 358 01	For boxes 310 x 240 and 360 x 270 mm

# Plexo™ boxes IP 55 - IK 07

## Dimensions

Cat.Nos 0 921 00/01

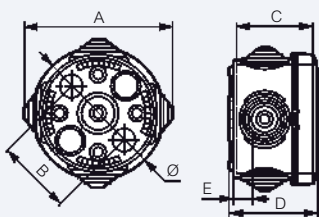

Cat.Nos	Ø	A	B	C	D	E
0 921 00	60	79	40	44.5	40	11
0 921 01	70	86	50	49.5	45	11

Cat.No 0 921 04

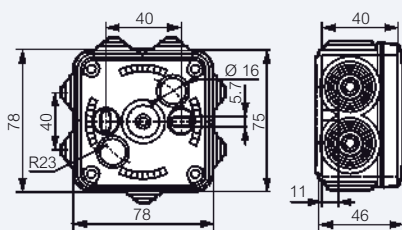

Cat.Nos 0 921 26/27

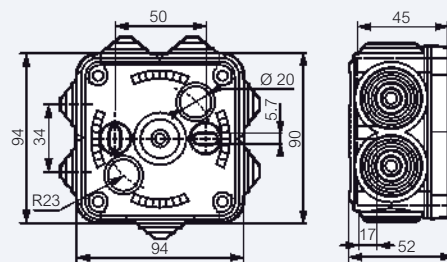

Cat.Nos 0 921 36/37

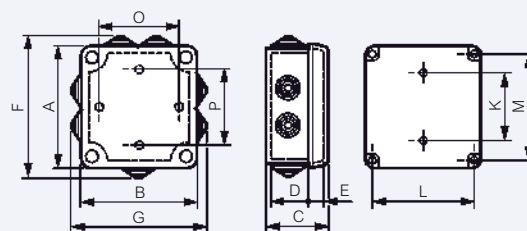

Cat.Nos	A	B	F	G	C	D	E	Fixing of box			S dm <sup>2</sup>	Fixing of accessories (screw Ø4 mm)	
								K	L	M		O	P
0 921 36	116	116	132	132	60	41.8	13.4	50	95	95	1.34	80	80
0 921 37	116	116	121	121	60	41.8	13.4	50	95	95	1.34	80	80

Plexo square boxes 130 x 130 mm Cat.Nos 0 920 32/34

Plexo rectangular boxes Cat.Nos 0 920 42/44/52/54/62/64/82/84/92/94

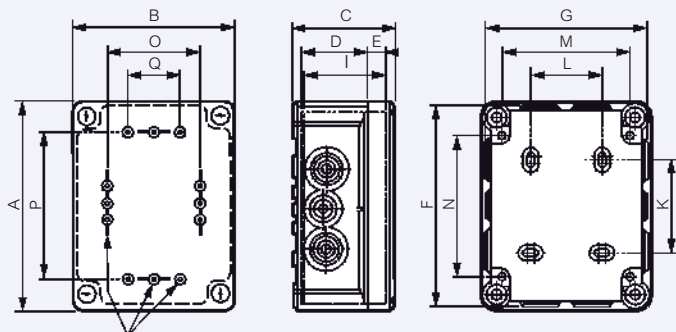

Fixing slots

Cat.Nos	Dimensions (mm)	A	B	F	G	C	D	E	I	Fixing of box				Fixing of accessories (screw Ø4 mm)		
										K	L	M	N	O	P	Q
0 920 32/34	130 x 130 x 74	150	150	149	149	81	56	18	67	54	70	120	103	106	106	84
0 920 42/44	155 x 110 x 74	175	130	173	128	81	56	18	67	79	50	100	128	86	131	64
0 920 52/54	180 x 140 x 86	200	160	205	165	94	69	18	80	104	50	130	153	116	156	94
0 920 62/64	220 x 170 x 86	240	190	245	195	94	69	18	80	144	80	160	193	146	196	124
0 920 82/84	310 x 240 x 124	332	262	340	270	132	97	27	116	220	160	222	276	200	260	150
0 920 92/94	360 x 270 x 124	382	292	390	300	132	97	27	116	270	190	252	326	230	310	150

## Technical characteristics

### Additional regulation

In accordance with European directive RoHS (2002/95/CE modified by decision 2005/618/CE) and with its FAQ "guidance for EEE directives", widened to all halogenated flame retardants, Plexo boxes (Cat.Nos mentioned below) don't contain halogenated flame retardant:

0 920 32/0 920 42/0 920 44/0 920 52/0 920 62/0 920 82/0 921 26/0 921 36

### Equipment with terminal blocks

Boxes (mm)	Bare terminal blocks on support and IP 2X blocks						Max. number of Nylobloc auto terminal support
	4 holes	8 holes	13 holes	17 holes	22 holes	35 holes	
130 x 130 x 74	•	•					4
155 x 110 x 74	•	•	•				4
180 x 140 x 86	•	•	•				6
220 x 170 x 86	•	•	•	•	•		10
310 x 240 x 124	•	•	•	•	•	•	10
360 x 270 x 124	•	•	•	•	•	•	10

### Spare membrane glands for Plexo boxes

• Direct entry

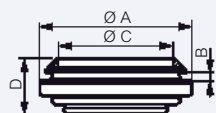

• To be cut

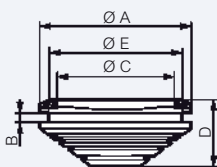

	A (mm)	B (mm)	C (mm)	D (mm)	E (mm)
					
Ø20	Ø27.6	2	Ø20	10	Ø22
Ø25	Ø33.8	2	Ø25	12.8	Ø27.5
Ø32	Ø42	2	Ø32.2	14.5	Ø34.6
Ø40	Ø50	2	Ø40.2	16.2	Ø42.5

	A (mm)	B (mm)	C (mm)	D (mm)	E (mm)
					
Ø20	Ø27.6	2,4	Ø20,2	15,5	Ø22
Ø25	Ø33,8	2,4	Ø25,6	18	Ø27,5

### User of membrane glands per type of boxes

Boxes	Membrane glands			
	Ø20	Ø25	Ø32	Ø40
<b>Round</b>				
Ø60	4			
Ø70	4			
<b>Square</b>				
65 x 65 x 40	7			
80 x 80 x 45	7			
105 x 105 x 55		7		
130 x 130 x 74	2	8		
<b>Rectangular</b>				
155 x 110 x 74	2	8		
180 x 140 x 86		4	6	
220 x 170 x 86		8	6	
310 x 240 x 124			18	6
360 x 270 x 124			16	8

## Plastic industrial boxes

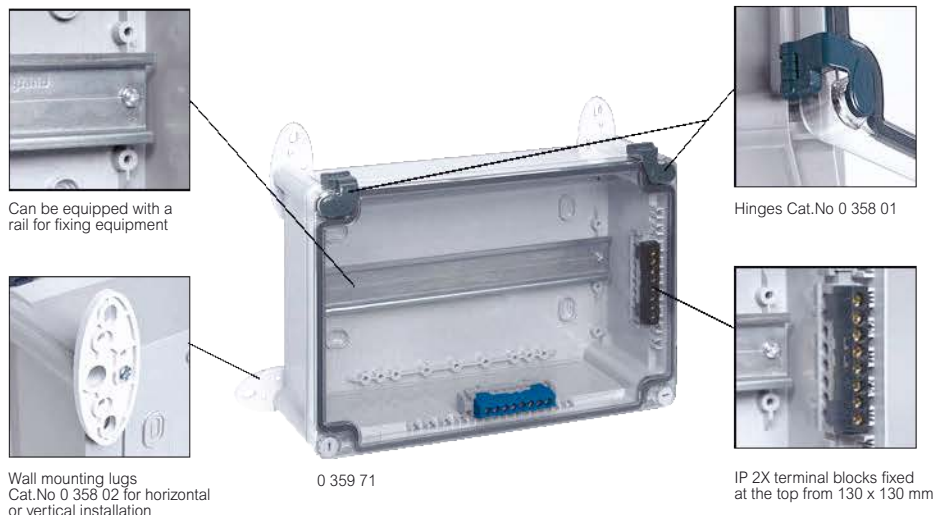

Smooth surfaces

Choice of fixing:

- Internal: 4 oblong holes at back of box
- At the 4 corners outside the wiring space, with Ø4 screws
- Using wall mounting lugs Cat.No 0 358 02 (except boxes 130 x 75 x 74 mm)

Pack	Cat.Nos		IP 55 - IK 07 grey RAL 7035
	Opaque cover	Transparent cover	Class II provided by protective caps for the fixing screws (supplied) Equipment can be fixed on rail or solid plate IP 2X terminal blocks fixed at the top from 130 x 130 mm size (p. 180) Cover opened/closed with 1/4 turn of a flat screwdriver. Indication of closed/open position: I/O Captive covers with ties, except boxes 310 x 240 mm and 360 x 270 mm
			Internal dimensions Height x Width x Depth (mm)
5/50	0 921 28		80 x 80 x 45
5/50	0 921 38		105 x 105 x 55
1	0 359 00		130 x 75 x 74
1	0 359 30		130 x 130 x 74
1	0 359 40		155 x 110 x 74
1	0 359 50		180 x 140 x 86
1	0 359 60	0 359 61	220 x 170 x 86
1	0 359 70	0 359 71	270 x 170 x 86
1	0 359 80		310 x 240 x 124

Pack	Cat.Nos	IP 55 - grey RAL 7035 - increased depth
2	0 921 22	<b>Box depth 140 mm</b> IK 07 220 x 170 x 240 mm with 4 locks
1	0 350 58	<b>Box depth 154 mm</b> IK 08 359 x 265 x 154 mm with hinges and 2 locks
1	0 922 84	<b>Box depth 160 mm</b> IK 08 310 x 240 x 160 mm with 4 locks

Pack	Cat.Nos	Accessories for IP 55 - IK 07 grey RAL 7035
		<b>Hinges</b> RAL 7016 - set of 2
1	0 358 00	For boxes 130 x 130 up to 270 x 170 mm included
1	0 358 01	For boxes 310 x 240 mm and 360 x 270 mm
		<b>Metal mounting plates</b> Galvanized steel 15/10 thick
5	0 358 10	For boxes 130 x 130 mm
5	0 358 11	For boxes 155 x 110 mm
5	0 358 12	For boxes 180 x 140 mm
5	0 358 13	For boxes 220 x 170 mm
5	0 358 14	For boxes 270 x 170 mm
5/10	0 358 15	For boxes 310 x 240 mm
		<b>Wall mounting lugs</b> Set of 4 lugs for boxes from width 110 mm For wall fixing supplied with screws
1	0 358 02	



Weatherproof cabinets, p. 240-253



# Plastic industrial boxes

## Characteristics - IP 55 - IK 07 boxes

Box: - IP 55: polypropylene  
 Cover: - opaque: polypropylene (except 0 359 80: polycarbonate)  
 - transparent: polycarbonate  
 Operating temperature: - 25 °C to + 40 °C  
 Self-extinguishing: 750 °C (EN 60695-2-11)  
 For indoor use

## Dimensions

### Boxes

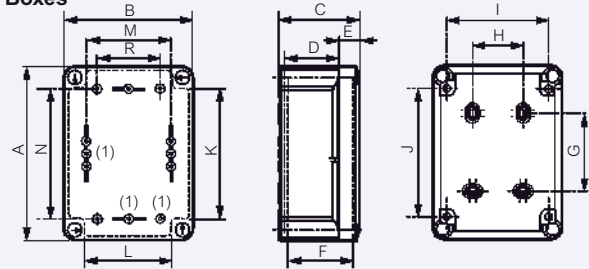

1: Fixing for accessories (rail, mounting plates)

Cat.Nos	Dimensions (mm)																Box fixing (mm)		Accessories fixing (Ø4 mm screw supplied)	
	A	B	C	D	E	F	G	H	I	J	K	L	M	N	R	G	H	I	J	
0 359 00	140	85	81	56	18	67	70	-	65	120	-	-	51	106	-	-	-	-	-	
0 359 30	150	150	81	56	18	67	54	70	120	103	102	87	106	106	84	-	-	-	-	
0 359 40	175	130	81	56	18	67	79	50	100	128	112	88	86	131	64	-	-	-	-	
0 359 50	200	160	94	69	18	80	104	50	130	153	137	112	116	156	94	-	-	-	-	
0 359 60/61	240	190	94	69	18	80	144	80	160	193	175	142	146	196	124	-	-	-	-	
0 359 70/71	290	190	94	69	18	80	194	80	160	243	226	142	146	246	122	-	-	-	-	
0 359 80	332	262	132	97	27	116	220	160	222	276	248	198	200	260	150	-	-	-	-	

### Cat.No 0 921 28

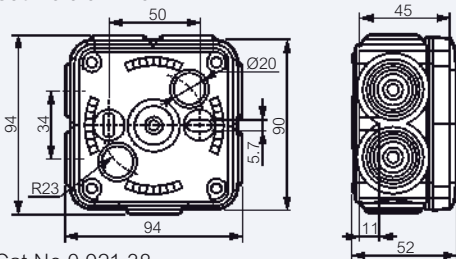

### Cat.No 0 921 38

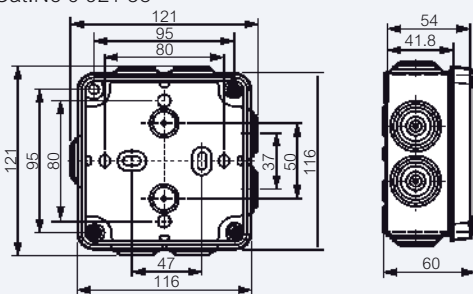

## Metal mounting plates

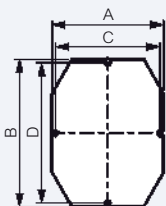

Cat.Nos	A	B	C	D
0 358 10	114	114	106	106
0 358 11	94	139	86	131
0 358 12	124	164	116	156
0 358 13	154	204	146	196
0 358 14	154	254	146	246
0 358 15	211	271	200	260

## Maximum length of terminals

Box dimensions (mm)	Number of holes
130 x 130 x 74	8
155 x 110 x 74	13
180 x 140 x 86	13
220 x 170 x 86	22
310 x 240 x 124	28

## Characteristics - IP 55 - increased depth boxes

Operating temperature: - 20 °C to + 50 °C  
 Self-extinguishing: 750 °C (EN 60695-2-11)  
 For indoor use

## Dimensions

### Boxes

#### Cat.No 0 921 22

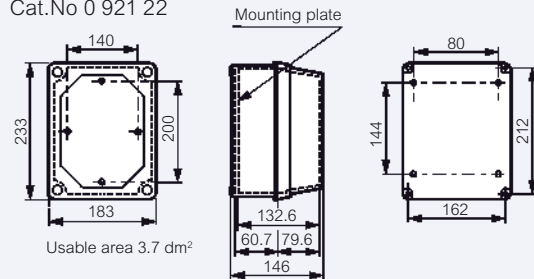

Usable area 3.7 dm<sup>2</sup>

#### Cat.No 0 350 58

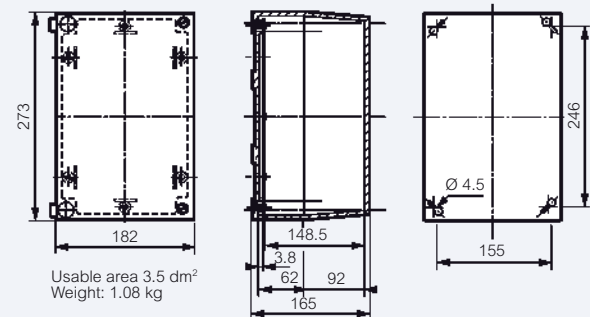

Usable area 3.5 dm<sup>2</sup>  
 Weight: 1.08 kg

#### Cat.No 0 922 84

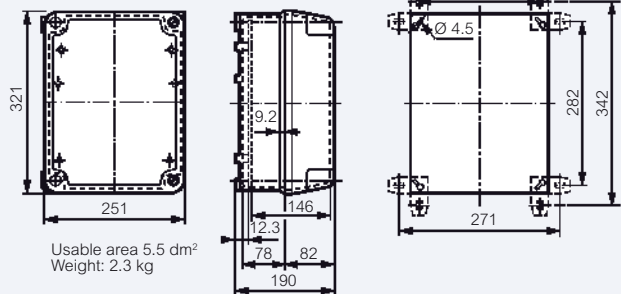

Usable area 5.5 dm<sup>2</sup>  
 Weight: 2.3 kg

## Flexible conduits



6 510 16



6 512 16

Accessories for conduits p. 568

Flame-retardant  
 Conform to standard EN 61386-21 and IEC 61386-2  
 Crush resistance: 750 Newtons  
 Supplied wrapped in film, the coil acts as a pay-out reel  
 The various diameters are identified by coloured ties  
 Surface-mounting or flush-mounting

Pack	Cat. Nos	Medium impact (ICA 3321)		
		Shock resistance: 2 joules at - 5 °C Min operating t°: - 5 °C Max operating t°: + 60 °C Flush-mounted in certain cases before construction of the masonry		
		∅ exterior (mm)	∅ interior (mm)	thickness (mm)
100	6 510 16	16	10.7	2.65
100	6 510 20	20	14.1	2.95
100	6 510 25	25	18.3	3.35
50	6 510 32	32	24.3	3.85
50	6 510 40	40	31.2	4.40
50	6 510 50	50	39.6	5.20

Pack	Cat. Nos	High impact with draw wire (ICTA 3422)		
		Shock resistance: 6 joules at - 5 °C Min operating t°: - 5 °C Max operating t°: + 90 °C IK 08 Surface mounting not recommended outside Suitable for prefabricated concrete		
		∅ exterior (mm)	∅ interior (mm)	thickness (mm)
100	6 512 16	16	10.7	2.65
100	6 512 20	20	14.1	2.95
100	6 512 25	25	18.3	3.35
50	6 512 32	32	24.3	3.85
50	6 512 40	40	31.2	4.40
50	6 512 50	50	39.6	5.20
25	6 512 63	63	52.6	5.20

## Flexible conduits

### Characteristics

Wire cross-section in mm <sup>2</sup>	Occupation cross-section in mm <sup>2</sup>	Number of external ∅ of ducts to be used		
		Conductor*	Flexible*	Rigid*
1.5	8.55	2	16	16
		3	16	16
		4	20	16
		5	20	16
2.5	11.9	2	16	16
		3	20	16
		4	20	20
		5	25	20
4	15.2	2	20	16
		3	20	20
		4	25	20
		5	25	25
6	22.9	2	20	20
		3	25	20
		4	32	25
		5	32	25
10	36.32	2	25	20
		3	32	25
		4	32	32
		5	40	32
16	50.3	2	32	25
		3	32	32
		4	40	32
		5	40	40
25	75.4	2	32	32
		3	40	40
		4	50	40
		5	50	50
35	95.03	2	40	32
		3	50	40
		4	50	50
		5	63	50
50	132.7	2	50	40
		3	50	50
		4	63	63
		5	63	63
70	176.7	2	50	50
		3	63	63
		4	63	63
		5		
95	227	2	63	63
		3	63	63
		4		
		5		
120	283.5	2	63	63
		3		63
		4		
		5		
150	346.3	2	63	63
		3		
		4		
		5		

\* Based on H 07 V - U/R

### Use

#### Surface-mounting or flush-mounting for electrical installations in residential buildings

		Rigid reinforced	Reinforced flexible	Flexible and rigid
Surface-mounting	Exterior	●	●	●
	Interior	●	●	●
Flush-mounting	Before construction	Walls	●	●
		Floors	●	●
	After construction	●	●	●

● Possible    ● Not recommended    ● Prohibited

Reinforced flexible conduit with wire puller: flexible annular, suitable for prefabricated concrete

Annular flexible conduit: flexible, without wire puller

Rigid conduit with integrated sleeves: rigid, smooth, without wire puller

# Batibox™

## flush-mounting boxes for dry partitions



Installation **see e-catalogue**

Pack	Cat.Nos	1-gang boxes	Junction boxes
20	0 800 40	<b>For 1 module</b> Drilling diameter 32 mm Depth 40 mm <b>For 1 gang or 2 modules</b> For wiring accessories using screws or claws Drilling diameter 67 mm Depth 40 mm	Supplied with cover and screws Knockout base Box ext. dim. (mm)   Cover dim. (mm)
50	0 800 41	Depth 40 mm	10   0 893 72   115 x 115 x 40 mm   140 x 140 mm
50	0 800 51	Depth 50 mm	10   0 893 73   160 x 105 x 40 mm   190 x 135 mm
			10   0 893 74   170 x 170 x 50 mm   195 x 195 mm
			10   0 893 75   230 x 170 x 50 mm   225 x 210 mm
		<b>Multi-gang boxes</b> For mounting equipment using screws Drilling diameter 67 mm Supplied with 1 removable divider for accommodating extended functions <b>For 83.5 mm fixing centres</b> Compatible with: Arteur and Mosaic ranges 3 modules horizontal mounting <b>For 60 and 71 mm fixing centres</b> Compatible with: Arteur, Galea Life, Mosaic, Valena, Niloé, Kaptika 2-gang or 4/5 modules Horizontal or vertical use	<b>Batibox multimedia boxes</b> Multi-material flush-mounting boxes for connecting wall-mounted LCD or plasma screens Supplied with 2 Mosaic programme 5-module supports for flush-mounting high/low current functions (e.g.: 2P+E, TV sockets, HDMI, RCA sockets, etc.) Supplied without sockets Can be installed in advance to reserve the future space for a screen Extra-slim cover with cut-out panel for cable outlet Equipped with a site protective cover Storage space for cords Supplied with retaining bar for cords Suitable for solid or cavity walls. Depth: 50 mm
15	Depth 40: 0 800 49   Depth 50: 0 800 52	3 modules horizontal mounting	1   0 801 93   Max. capacity: 1 x 5 modules Dimensions: 142 x 142 mm
30	0 800 42   0 800 52	2-gang or 4/5 modules Horizontal or vertical use	1   0 801 95   Max. capacity: 2 x 5 modules Dimensions: 285 x 142 mm
30	0 800 43   0 800 53	3-gang or 6/8 modules Horizontal or vertical use	
30   15	0 800 44   0 800 54	4-gang or 8/10 modules Horizontal or vertical use	
		<b>Universal covers</b> For converting wiring devices boxes into junction boxes or for closing up an existing box Supplied without fixing screws For one-gang or multi-gang boxes	
20	0 801 80	Round cover, Ø85 mm, for 1-gang box	
20	0 892 81	Square cover, 80 x 80 mm, for 1-gang box	
10	0 801 82	Cover for Batibox 2-gang box	
		<b>Accessory</b> Long screw Ø3 mm length 40 mm	

Installation of flush-mounting boxes for dry partitions **see e-catalogue**



# Universal box and flush-mounting boxes for masonry



0 313 01 (fitted alongside)



0 801 41 + 0 801 99



2 x 0 801 08 (back to back joining)

## Installation p. 567

Pack	Cat.Nos	Universal 1-gang box	Pack	Cat.Nos	Multi-gang boxes for multi-material
250	0 313 01	<p>For screw or claw mounting Supplied without screws Can be used with Arteur, Galea Life, Mosaic, Vela, Valena, Niloé and Kaptika ranges, Horizontal and vertical mounting 1-gang unit Can be fitted alongside one another Can be used as junction box with cover Cat.No 0 892 81</p> 	1	0 801 24	For Arteur, Mosaic Depth 50 mm 2 x 2 gang or 2 x 4/5 modules Dimensions: 142 x 142 mm
10	0 801 40	<p><b>1-gang boxes for masonry</b> <b>For 1 module</b> Depth 40 mm - Width 32 mm <b>Square boxes for joining together</b> For wiring accessories using screws or claws 1-gang boxes can be used to make up multi-gang boxes by joining Can be used horizontally or vertically 71 mm fixing centres Cutting out of internal partitions for mounting extended functions Supplied with screws fitted with protective shield Knockout cable entries, Ø16-20-255</p> 	1	0 801 26	2 x 3 gang or 2 x 6/8 modules Dimensions: 213 x 142 mm
100	0 801 41	<p><b>Round for joining together back to back</b> Upper flange can be cut to obtain a depth of 30 mm (for controls, 2-way switches, push-buttons, etc.) Boxes can be joined back to back by 1/4 of a turn Adjustable dimensions (80, 70 or 60 mm) by cutting the flange With screws Depth 40 mm - Ø67 mm</p> 	1	0 801 28	2 x 10 modules Dimensions: 284 x 142 mm
100	0 801 51		<p><b>Box for 20 A and 32 A sockets</b> <b>1-gang 85 x 85 mm</b> For cable outlets Cat.No 0 314 90, 20 A sockets and 32 A sockets Depth 50 mm Vertical positioning of the screws for fixing 20 A and 32 A sockets</p> 	5	0 801 85
100	0 801 08		5	0 801 55	<p><b>Box for shaver socket</b> For Mosaic shaver socket Cat.No 0 744 86, and Arteur shaver sockets (p. 397) Depth 50 mm</p> 
10	0 801 49	<p><b>Multi-gang boxes for masonry</b> <b>Batibox</b> For 3 module Arteur, Vela, Mosaic ranges Supplied with screws Depth 40 mm Knockout cable entries, Ø16-20-25 <b>Italian type boxes for masonry</b> For screw or claw mounting devices Arteur, Mosaic, Vela ranges Supplied without screws Horizontal mounting Depth 50 mm</p> 	50	0 892 46	<p><b>Luminaire box with cover</b> <b>For striplights</b> Ø40 mm - depth 40 mm</p> 
1	0 892 39	<p>For 3 modules - 106 x 71 mm For 4 modules - 130 x 71 mm For 6 modules - 186 x 71 mm</p>	20	0 801 80	<p><b>Universal covers</b> For converting wiring devices boxes into junction boxes or for closing up an existing box Supplied without fixing screws For one-gang or multi-gang boxes Round cover, Ø85 mm, for 1-gang box</p> 
1	0 892 49		20	0 892 81	Square cover, 80 x 80 mm, for 1-gang box
1	0 892 50		10	0 801 82	Cover for Batibox 2-gang box, 71 mm fixing centres



## Batibox™ - flush-mounting boxes for masonry

## Batibox™ - flush-mounting boxes for masonry



0 819 40



0 819 60

Pack	Cat.Nos	Complete junction boxes												
		<b>Rectangular with knockout cable entries</b>												
		Boxes supplied with cover and screws Supplied with plaster shield (except for Cat.No 0 892 71)												
		<table border="1"> <thead> <tr> <th>Box ext. dim. (mm)</th> <th>Cover dim. (mm)</th> </tr> </thead> <tbody> <tr> <td>85 x 85 x 40</td> <td>100 x 100</td> </tr> <tr> <td>120 x 120 x 40</td> <td>140 x 140</td> </tr> <tr> <td>165 x 115 x 40</td> <td>190 x 135</td> </tr> <tr> <td>175 x 175 x 40</td> <td>195 x 195</td> </tr> <tr> <td>230 x 180 x 50</td> <td>255 x 210</td> </tr> </tbody> </table>	Box ext. dim. (mm)	Cover dim. (mm)	85 x 85 x 40	100 x 100	120 x 120 x 40	140 x 140	165 x 115 x 40	190 x 135	175 x 175 x 40	195 x 195	230 x 180 x 50	255 x 210
Box ext. dim. (mm)	Cover dim. (mm)													
85 x 85 x 40	100 x 100													
120 x 120 x 40	140 x 140													
165 x 115 x 40	190 x 135													
175 x 175 x 40	195 x 195													
230 x 180 x 50	255 x 210													
		<b>Large capacity</b>												
		Accept Ø25 and 32 tubes												
2	0 892 77	400 x 180 x 70 mm												
2	0 892 78	390 x 245 x 70 mm												
		<b>Box for concrete walls</b>												
		<b>One-gang box</b>												
		For mounting												
		- in wooden casing alone,												
		- with blanking cover Cat.No 0 819 72												
		Fixing of screw or claw-mounting wiring accessories with ring Cat.No 0 819 60												
		Can be combined side by side with cover Cat.No 0 819 71 (consult us)												
		<b>Cover for concrete boxes</b>												
		Installation/blanking cover used for installation on wooden casing or for blanking in back to back mounting												
		<b>Ring</b>												
		Ø64 mm ring for 1-gang box												
		Cat.No 0 819 60												
		Supplied with screws												
		<b>Accessory</b>												
		<b>Screw</b>												
		Long screw Ø3 mm length 40 mm for all Batibox boxes												
		<b>Fixing accessory</b>												
		Fits on Batibox boxes for masonry and concrete, for fixing directly in the wall												
		The Soliroc plate can be fixed onto this accessory with no need for drilling or using plugs in the wall												
		1-gang, can be joined to create 2-gang												

Pack

Cat.Nos

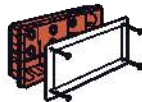
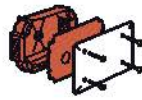

### Installation

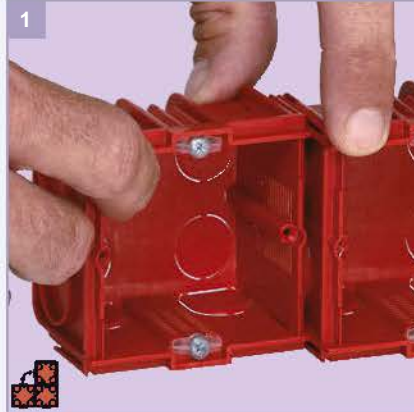

1

Horizontal or vertical joining of 1 gang boxes (Cat.No 0 801 41)



2

The sides can be removed before or after joining

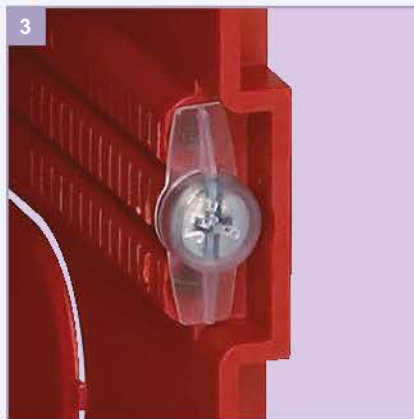

3

The screws are supplied with protection cap (against plaster)

## Rigid conduits



6 514 16



0 319 06



0 319 00



0 313 82



0 313 83



Conduit supports installation p. 569

### Pack Cat.Nos Rigid conduits with integrated coupling

Flame-retardant  
Surface-mounting or flush-mounting  
Suitable for prefabricated concrete  
Conforming to European standard:  
EN 61386-21 and IEC 61386-21  
Crush resistance: 750 Newtons  
Shock resistance: 2 joules at - 5 °C  
Min operating t°: - 5 °C  
Max operating t°: + 60 °C  
IK 07  
Can be used outside  
Supplied wrapped in film. Grey (RAL 7035)  
Length of tubes: 3 m

	Ø exterior (mm)	Ø interior (mm)	thickness (mm)
30	16	13	1.50
30	20	16.9	1.55
30	25	21.4	1.80
15	32	27.8	2.10

### Clipsotubes

Fixing by Ø7 mm thread 150 mm pin, screw-in wall plugs Cat.No 0 319 57, screw Ø5 mm or nail  
For interior use  
Holding of flexible and rigid conduits

	Grey RAL 7035	Ø mini (mm)	Ø maxi (mm)
100	0 319 03	15	16
100	0 319 04	18.4	20.6
100	0 319 06	22.3	25

### Cable ties with base

Adjustable for conduits IRL Ø16 to 32 mm or for cable Ø13 to 38 mm  
Fixing by Ø7 mm thread 150 mm pin, screw in wall plugs Cat.No 0 319 57, screw Ø5 mm  
Can be fixed using Pulsa 700 E staple gun  
For interior and exterior use - U.V. protected  
Black colour

100/1000 0 319 00 For interior use - Grey RAL 7035

### Conduit supports with screw-in wall plug

#### Conduit supports

100	0 313 80	For conduit Ø16
100	0 313 81	For conduit Ø20
50	0 313 82	For conduit Ø25

#### Conduit supports accessory

200 0 313 83 For fixing in plasterboard plate

## Accessories for flexible and rigid conduits



6 516 01



6 516 08



6 516 11



6 516 18



6 516 32

Grey (RAL 7035)

### Pack Cat.Nos Couplings

100	6 516 01	For connecting conduits of the same diameter
100	6 516 02	Ø16 mm
50	6 516 03	Ø20 mm
25	6 516 04	Ø25 mm



### Reducers

100	6 516 08	For connecting conduits of different diameters
50	6 516 09	Ø20 x 20 mm

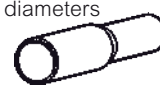

### Elbows

Used to change direction even after the wires have been installed. 2-part assembly to save time and simplify installation

50	6 516 11	Ø16 mm
50	6 516 12	Ø20 mm
25	6 516 13	Ø25 mm



### Tees

Used to join conduits together and to change direction even after the wires have been installed. 2-part assembly to save time and simplify installation

50	6 516 18	Ø16 mm
25	6 516 19	Ø20 mm
25	6 516 20	Ø25 mm



### Bends

20	6 516 26	90° curves
10	6 516 27	Ø20 mm - length: 130 mm
25	6 516 28	Ø25 mm - length: 160 mm
		Ø32 mm - length: 200 mm

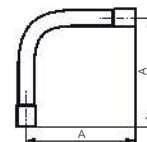

### Bending springs

Used to bend rigid conduits

	Ø (mm)	Length (mm)
1	6 516 32	16   600
1	6 516 33	20   800
1	6 516 34	25   800

### Nylon draw tape

Flexible cable which can be used to guide the wires into an unwired conduit. 2 metal end caps  
End cap diameter: 6 mm at both ends for attaching the wires  
Length: 20 m

1 6 516 36

## Fixing devices for conduits



Cable clips come packaged so as to allow for unit distribution and storage of unused clips

Pack	Cat.Nos	Screw-in wall plugs	
100	Black 0 319 57	For use with cable ties with base, clipsotube, conduit supports For fixing screw-on base and cable ties with base Ø8 mm drilling (Ø7 mm smooth material) Threaded head Ø6.6 mm pitch 150 Supplied with punch for inserting pin	
<b>Cable clips for concrete materials</b>			
<b>Multifix</b>			
Expanding cable clips, accept several sizes of cable			
	Grey	Cable	Pin
		Ø (mm)	Ø (mm)
1000	0 315 77	7 to 10	1.8
100	0 315 78	10 to 14	1.8
100	0 315 79	14 to 20	2.5
30	0 315 81	25 to 32	2.5
		Ø (inches)	Length (mm)
		9/32 to 25/64	25
		25/64 to 9/16	30
		9/16 to 5/8	40
		1 to 5/4	50
<b>Fixfor</b>			
	Grey RAL 7035	White	Cable
			Ø (mm)
2000	0 315 24	0 315 54	5
1000	0 315 25	0 315 55	6
1000	0 315 26	0 315 56	7
1000	0 315 27	0 315 57	8
1000	0 315 28	0 315 58	9
100	0 315 29		10
100		0 315 59	10
100	0 315 30		12
100	0 315 31		14
100	0 315 32		16
80	0 315 33		17
60	0 315 34		19
40	0 315 35		22
20	0 315 36		29
			Ø (inches)
			13/64
			15/64
			9/32
			5/16
			23/64
			25/64
			25/64
			15/32
			9/16
			5/8
			43/64
			3/4
			7/8
			1"9/64
			Ø (mm)
			1.8
			1.8
			1.8
			1.8
			1.8
			1.8
			1.8
			2.5
			2.5
			2.5
			2.5
			2.5
			2.5
			2.5
			2.5
			2.5

## Conduit supports

### Installation Cat.Nos 0 313 80/81/82 (p. 568)



Drill to diam. 8 mm



Strike conduit support



Untie unused elements



Conduit support is fixed



Clip conduit



Lock with flap



 Dimensions [see e-catalogue](#)
**Black Colson U.V. protected cable ties**

Pack	Cat.Nos	Black Colson U.V. protected cable ties			
		Conform to EN 50146 and IEC 62275			
		<b>External teeth</b>			
		Width (mm)	Flat length (mm)	Ø grip capacity (mm) max. min.	Tensile Strength (kg)
100/1000	0 319 10	9	123	22 4	36
100/1000	0 319 13	9	185	42 10	36
100/1000	0 319 16	9	262	62 26	53
100/1000	0 319 19	9	357	92 26	53
100/500	0 319 20	9	498	140 74	53
100	0 319 21	9	750	220 74	53
100	0 319 22	6	119	25 4	22
100/1000	0 319 25	6	180	45 10	22
		<b>Internal teeth</b>			
		Easy manual tightening			
100	0 319 28	7.6	128	22 8	36
100	0 319 29	7.6	194	42 15	45
100	0 319 30	7.6	260	62 15	45
100	0 319 32	7.6	359	92 15	45

Pack	Cat.Nos	Black U.V. protected bases
100/1000	0 319 55	Standard plug base Ø8 mm drilling (Ø7 mm smooth material)
100	0 319 58	Wall spacer plug base Ø8 mm drilling (Ø7 mm smooth material)
100	0 319 50	Screw-on base, can be fixed with plug Cat.No 0 319 57 or metal stud Ø7 mm pitch 150 or countersunk screw Ø5 mm

Pack	Cat.Nos	Black U.V. protected screw-in plug
100	0 319 57	For fixing screw-on base and cable ties with base Ø8 mm drilling (Ø7 mm smooth material) Threaded head Ø6.6 mm pitch 150 Supplied with punch for inserting pin

Pack	Cat.Nos	Black cable tie with U.V. protected base
100	0 319 02	Adjustable for conduits IRL Ø16 to 32 mm or for cable Ø13 to 38 mm Fixing by Ø7 mm thread 150 mm pin, screw in wall plugs Cat.No 0 319 57, screw Ø5 mm Can be fixed using Palsa 700 E staple gun For interior and exterior use - U.V. protected Black colour

Pack	Cat.Nos	Colson tool
1	0 319 96	Facilitates tightening and strip cut the nearest of Colson cable ties head

**Performance**

 Conform to EN 62275 type 1 (NFC 68-146)  
 "cable ties for electrical installations"

Test conditions:

- Temperature: 23 °C
- Relative humidity of air: 50 %
- Traction speed: 25.4 mm/min

**Ratchet force**

Cat.Nos	Ratchet force (daN)
0 319 10	4
0 319 13	4
0 319 16	5
0 319 19	5
0 319 20	5.5
0 319 21	5.5
0 319 22	4
0 319 25	4
0 319 28	1.5
0 319 29	1.5
0 319 30	1.5
0 319 32	1.5

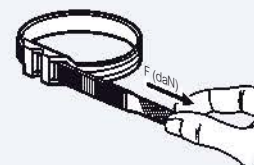
**Tensile strength**

Cat.Nos	Tensile strength	
	Test Ø (mm) according to EN 50146	Min. strength (daN)
0 319 10	20	36
0 319 13	20	36
0 319 16	26	53
0 319 19	26	53
0 319 20	74	53
0 319 21	74	53
0 319 22	20	22
0 319 25	20	22
0 319 28	20	36
0 319 29	20	45
0 319 30	20	45
0 319 32	20	45

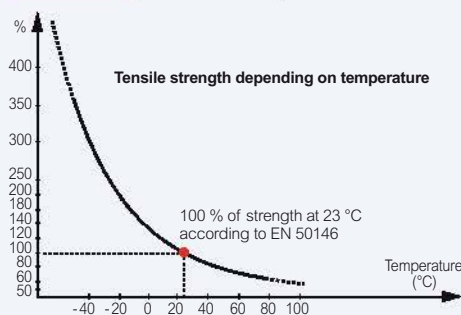
**Temperature resistance**

- operating (permanent use): from - 40 °C to + 85 °C
- operating (minimum): - 30 °C, 0 °C for Cat.Nos 0 319 28/29/30/32

**Resistance to external agents**

 Good resistance to bases, oils, greases, saline mist, oil products.  
 Sensitive to acids

**Fire resistance**

- Flame retardant
- Conform to UL 94 requirements, HB classification
- Needle-flame resistance according to IEC 60695-11-5
- Oxygen index (LOI) according to EN ISO 4589-1/ASTM D 2863-00: 20 %
- Halogen free polyamide

**UV protected according to norm IEC 62275 type 1**

 UV protected black cable ties for outdoor use  
 These black cable ties have successfully undergone UV resistance and climatic ageing tests representing actual conditions of use  
 These cycles combine a 1000 hours radiance under arc or xenon lamp according to ISO 4892-2 method 1

# Duplix™ marking system

for cables



Cat.No 0 384 52 with label and label-holder Cat.No 0 384 98



Cat.No 0 384 56 with marker and protective cover Cat.No 0 384 97



Opened marking system with marker-holders Cat.No 0 384 55

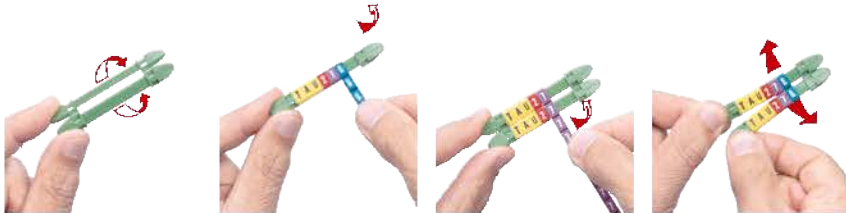

Clip-on marking system

Opened or closed marking system, with markers or labels

Pack	Cat.Nos		Marker-holders
	7 markers	14 markers	Fitted using Colring 2.4 and 3.5 mm cable ties
100	0 384 50	0 384 60	● Black
100	0 384 52	0 384 62	● Red
100	0 384 54	0 384 64	● Yellow
100	0 384 55	0 384 65	● Green
100	0 384 56	0 384 66	● Blue

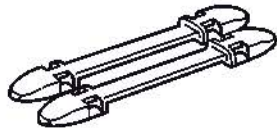

### Markers

Price per marker

#### Numbers:

Black or white marking on colour background (international colour code)

Supplied by packs of 40 x 20 markers

- 0 Black
- 1 Brown
- 2 Red
- 3 Orange
- 4 Yellow
- 5 Green
- 6 Blue
- 7 Purple
- 8 Grey
- 9 White



#### Letters:

Black on yellow background

Supplied by packs of 30 x 20 markers

- A
- B
- C
- D
- E
- F
- G
- H
- I
- J
- K
- L
- M
- N
- O
- P
- Q
- R
- S
- T
- U
- V
- W
- X
- Y
- Z



Pack	Cat.Nos	Markers (continued)
		<b>Conventional symbols:</b>
		Black on a yellow background
600	0 384 40	/
600	0 384 41	.
600	0 384 42	+
600	0 384 43	-
600	0 384 44	~
600	0 384 45	=
600	0 384 46	±
600	0 384 99	Blank
1	0 384 96	<b>Set of Duplix markers</b> 100 pieces of each number from 0 to 9
		<b>Accessories</b>
100	0 384 98	<b>Label-holder for 7 markers</b> Clips onto marker-holders Duplix or on end cap Cat. No 0 375 13 Holds and protects labels 9 mm
100	0 384 97	<b>UV protective cover</b> Enables closed cable marking system Clips onto label-holders for 7 markers

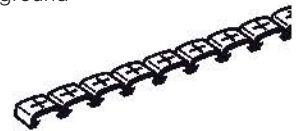

Other marking systems, p. 294



# Nylbloc™ auto

screwless connection terminals

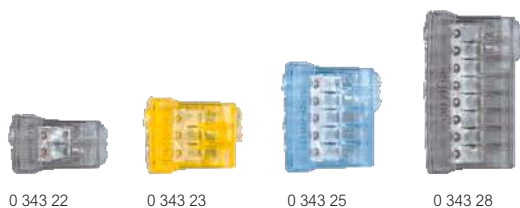

Pack	Cat.Nos	Screwless connection terminals - Nylbloc auto
100	0 343 22	No tool direct connection after simple stripping of copper conductors Test socket for tester screwdriver or test tip Cat.No 0 394 45 (p. 286) for IP 2X test or Ø4 mm tip on Nylbloc auto terminals Conform to EN 60998-2-2 For rigid cable from 0.75 to 2.5 mm <sup>2</sup> Stripping length: 11 mm Connection by separate crimping blades Transparent base providing full visibility of the connections Colour code to identify products Duplex marking possible on 3, 5 and 8-wire terminals Max. intensity: 24 A Insulating voltage: 450 V~ Grey terminal for 2 wires
100	0 343 23	Orange terminal for 3 wires
100	0 343 25	Blue terminal for 5 wires
50	0 343 28	Grey terminal for 8 wires

Pack	Cat.Nos	Accessories
5	0 343 99	<b>Conductor stripping tool</b> For cable desheathing and rapid wire stripping in flush-mounting and junction boxes, in trunking For cable Ø8 mm to 13 mm (from 2 G 1.5 to 5 G 2.5 mm <sup>2</sup> ) and wires 1.5 mm <sup>2</sup> and 2.5 mm <sup>2</sup>
10	0 343 98	<b>Nylbloc auto terminal support</b> For up to 3 screwless connection terminals Nylbloc auto (Cat.Nos 0 343 22/23/25/28) Direct fixing: - in top of Plexo boxes and industrial plastic cabinets ≥ 130 x 130 mm - on flat bar 12 x 2 mm - in bottom of fully assembled, adaptable and aluminium DLP trunkings (from 50 x 80 mm) Screw fixing: - in bottom of Plexo boxes ≥ 105 x 105 mm and industrial plastic cabinets - universal Fixing on rail with accessory Cat.No 0 048 11 (p. 180) Accessible test socket Marking zone with felt tip pen Cat.No 0 395 98 (p. 272)

# Nylbloc™

connection strips and connectors without screws



**Nylbloc connection strips**  
12 elements with captive screws  
Supplied with screws undone  
Flame retardant polypropylene (-25 °C to + 100 °C)  
Ambient temperature from -25 °C to + 55 °C (T 55)  
Conform to EN 60998-2-1 and EN 60664-1  
Self-extinguishing to EN 60695-2-11 at 850°  
Insulation voltage: 250 V according to EN 60 998-2-1  
Use at 400 V integrated in a series of products that comply with the requirements of EN 60664-1, pollution degree 2, overload category III

Pack	Cat.Nos	Rated capacity (mm <sup>2</sup> )	Hole Ø (mm)	Max current (A)
10	0 342 11	2.5	2.5	24
	0 342 13	6	3.5	41
	0 342 15	10	4.5	57
	0 342 17	16	5.5	76
	0 342 19	25	7	101
10	0 342 21	2.5	2.5	24
	0 342 23	6	3.5	41
	0 342 25	10	4.5	57
	0 342 27	16	5.5	76

Pack	Cat.Nos	Nominal capacity (mm <sup>2</sup> )	No of cables and corresponding sections (mm <sup>2</sup> )	Cap colour	Packaging type
1000	0 343 38	1.5	3 to 5 of 0.5 <sup>2</sup> 2 to 4 of 0.75 <sup>2</sup>	blue	box
1000	0 343 44	1.5 to 2.5	2 of 1.5 <sup>2</sup> 3 to 5 of 0.5 <sup>2</sup> 2 to 5 of 0.75 <sup>2</sup> 2 to 3 of 1.5 <sup>2</sup>	orange	box
2000	0 343 51	4	2 of 2.5 <sup>2</sup> 2 to 4 of 1.5 <sup>2</sup> 2 to 3 of 2.5 <sup>2</sup>	yellow	box
100	0 343 57	6	2 of 4 <sup>2</sup> 2 to 5 of 2.5 <sup>2</sup> 2 to 3 of 4 <sup>2</sup>	red	box
2 000	6 340 51	4	2 of 6 <sup>2</sup> 2 to 4 of 1.5 <sup>2</sup> 2 to 3 of 2.5 <sup>2</sup>	yellow	bucket
1 500	6 340 52	6	2 of 4 <sup>2</sup> 2 to 5 of 2.5 <sup>2</sup> 2 to 3 of 4 <sup>2</sup>	red	bucket

## Line taps and equipotential bonding connectors



0 340 03



0 340 33



0 340 42



0 340 45



0 343 85

### Pack Cat.Nos Line taps

#### Strip of 10 separable line taps

Pack	Cat.Nos	Capacity per tap (mm <sup>2</sup> )	Width (mm)
10	0 340 00	2 x 6	15
10	0 340 01	2 x 10	19.5
10	0 340 02	2 x 16	21
10	0 340 03	2 x 25	21.5
10	0 340 04	2 x 35	25

#### Non-shear line taps

##### Hexagonal head

Pack	Cat.Nos	Capacity per tap (mm <sup>2</sup> )	Width of slot (max. cable $\varnothing$ in mm)	Overall height (mm)	Fixing centres (mm)
20	0 340 33	2 x 25	7.4	49	
10	0 340 34	2 x 50	9.5	59	
20	0 340 42	2 x 16	5.8	41	37
20	0 340 43	2 x 25	7.4	49	37
10	0 340 44	2 x 50	9.5	59	44
10	0 340 45	2 x 75	11.7	71	62

#### Equipotential bonding connectors

Used to make equipotential connections on the installation busbar systems

Safe, intuitive 1/4 turn mounting ensuring an excellent, lasting equipotential link

Pack	Cat.Nos	Busbar system		Max. connection cross-section (mm)
		$\varnothing$ min. (mm)	$\varnothing$ max. (mm)	
20	0 343 85	12	16	6
10	0 343 86	18	22	16
10	0 343 87	28	32	16

## Screwless connection terminals and equipotential bonding connectors

### Screwless connection terminals

#### Connection terminals Nylbloc auto Cat.Nos 0 343 22/23/25/28

Ambient temperature: - 25 °C to + 55 °C (T55)  
Self-extinguishing: 960 °C according to EN 60695-2-11  
Halogen free polycarbonate



#### Use



Cat.No 0 343 99 tool for cable desheathing and rapid wire stripping



Test via IP 2X test tip  
Cat.No 0 394 45



Plexo box with support  
Cat.No 0 343 98 directly fixed on top part

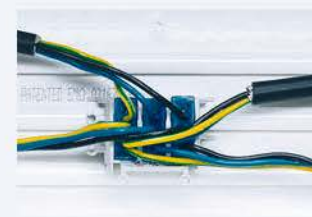

Trunking adaptable DLP with support  
Cat.No 0 343 98 directly fixed

### Equipotential bonding connectors

#### Characteristics

- Resistance to incandescent wire 960°C
- Resistivity  $\leq 0.4 \text{ m}\Omega$
- Polyamide
- Grey

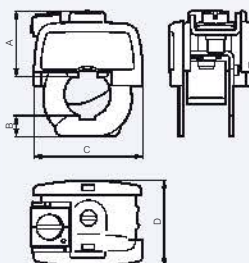

Cat.Nos	Dimensions (mm)			
	A	B	C	D
0 343 85	24	8	40.5	31.5
0 343 86	24	9	49	40
0 343 87	24	11	59	46.5

#### Installation



1 Fixed with a quarter turn



2 Held in place by a stainless steel spring blade



3 Final locking with 5.5 mm screwdriver



4 Connecting the equipotential bonding with a through and/or terminating connection

## Special plugs

double function



## British standard plugs, travel adaptors and TV plugs

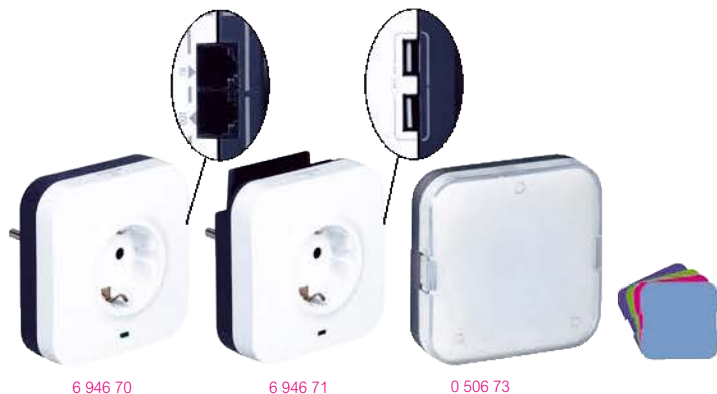

Pack	Cat.Nos	German standard double function plugs 250 V~
5	0 504 62	<b>Plug with 2P+E 16 A socket</b> Wires onto a cord connected to a device, enabling a second device to be connected to the same socket Plug 16 A/250V - 3680 W To be connected to a flexible cord 3G 1.5 mm <sup>2</sup>
5	0 504 09	<b>Plug with switch, 16 A</b> For fitting on a class I domestic appliance or a multi-outlet extension, which does not have an on/off button as standard Plug 16 A/250 V - 3680 W To be connected to a 3G 1.5 m <sup>2</sup> flexible cord
1	6 946 70	<b>German standard protected sockets</b> <b>2P+E + 2 x RJ 45 socket with voltage surge protector</b> Protection of electrical and electronic devices and the telephone circuit against lightning and overvoltages With indicator showing the status of the voltage surge protector ADSL compatible RJ 45/RJ 11 I/O: Uc: 200 V, Uoc: 2 kV and Up: 600 V Supplied with 1.5 m RJ 11 cord
8	6 946 71	<b>Socket: 2P+E + 2 x USB + telephone support with voltage surge protector</b> Protection of electrical and electronic devices against lightning and overvoltages With indicator showing the status of the voltage surge protector 5 V/1000 mA USB charger sockets for charging tablets, MP3 or MP4 players, mobile phones, etc. Telephone support with non-slip coating Supplied with 1 m retractable cable with micro-USB plug
8	0 506 73	<b>Night light with LED with light-sensitive sensor, 230 V</b> With light sensitive sensor for automatic lighting according to the light level threshold LED technology Supplied with 4 solid-coloured labels and 1 customisable paper label

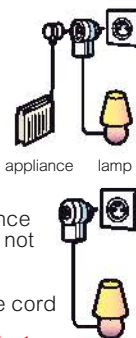

Pack	Cat.Nos	British standard plugs
20	0 503 26	13 A - 250 V~ - 2P+⊕ ASTA certification
20	6 500 13	13 A - 250 V~ - 2P+⊕
20	6 500 15	15 A - 250 V~ - 2P+⊕
		<b>Travel adaptors</b> With safety shutters For connecting a plug onto a different standard socket ○ White/Grey
10	Cardboard 0 503 83	<b>British standard adaptor → French standard adaptor</b> 2P+E - 16 A outlet - 13 A input - 3.000 W at 230 V~ British standard plug on a French or German standard socket
10	0 503 82	<b>German standard adaptor → French standard adaptor</b> 2P+E - 16 A outlet - 3.680 W in 230 V~ German standard plug (countries: Germany, Spain, Austria, Portugal, Greece, Hungary...) on a French socket
10	0 503 85	<b>2P adaptors - Euro/US</b> US standard → European standard US standard plug on a French or German standard socket - 1.380 W max.
10	0 503 86	European standard → US standard French or German standard plug on a US standard socket - 1.875 W max.
50	0 500 09	<b>TV plugs</b> ø9.52 mm Male plug
50	0 500 10	Female plug

Operation of night light sensor  
 Cat.No 0 506 73

Operation of socket with telephone support  
 Cat.No 6 946 71



# German standard plugs and extensions



Pack	Cat.Nos		
			<b>2P plug - 16 A - rubber</b>
	Bulk	Gencod labelling	For the supply of class II devices 2 x 1.5 mm <sup>2</sup> max. cable
25	0 504 51	0 501 81	● Black - straight outlet
			<b>2P+E plugs - 16 A and extensions - rubber</b>
			Screw terminals IK 08 - H07 RNF 3G 2.5 mm <sup>2</sup> max. cable
10	Bulk	Gencod labelling	<b>Plugs</b>
10	0 503 42	0 501 96	● Black - IP 44, screw cable grip
	0 503 40		● Black - IP 44 + cable gland Robust gland-type cable grip which guarantees weatherproofing and tightening without tools. Optimum hold with traction of the cable grip: 30 kg at 2.5 mm <sup>2</sup> max.
10	0 502 52	0 969 29	● Black - Side outlet with ring, screw cable grip
10	0 503 43	0 501 97	● Black, screw cable grip
10	0 503 44	0 501 98	● Black - IP 44 with cap and plug inserted, screw cable grip
10	0 503 41		● Black + cable gland Robust gland-type cable grip which ensures weatherproofing and tightening without tools. Optimum hold with traction of the cable grip: 30 kg at 2.5 mm <sup>2</sup> max.
5	0 513 66		● Black - 3 x 2P+E - IP 44 - with caps
5	0 513 69		● Black - 3 x 2P+E - IP 44 - with caps and plugs inserted
			<b>2P plugs and extensions - plastic - with extraction ring</b>
	Gencod labelling		<b>6 A</b>
30	0 501 62		○ Plug - White
15	0 501 66		○ Extension - White
30	0 501 63		● Plug - Black
30	0 501 64		● Plug - Bronze
30	0 501 65		○ Plug - Aluminium
			<b>10 A</b>
30	0 503 12		○ Plug - White
30	0 503 14		● Plug - Black
30	0 503 13		● Plug - Bronze
15	0 503 05		○ Extension - White
15	0 503 06		● Extension - Black
			<b>2P plugs - 16 A - extra-slim - plastic</b>
	Gencod labelling		Side outlet plugs, ideally behind an item of furniture 2 x 1.5 mm <sup>2</sup> max. cable, screw cable grip
15	0 501 83		○ White
15	0 501 84		● Black
			<b>2P+E plugs - 16 A and extensions - plastic</b>
	Bulk	Gencod labelling	
25	0 503 15	0 501 87	○ Straight outlet plug - White
25	0 503 16	0 501 88	○ Side outlet plug - White
15	0 503 17	0 501 89	○ Straight outlet extension - White
25		0 501 77	● Straight outlet plug - Black
25		0 501 78	● Side outlet plug - Black
15		0 501 79	● Straight outlet extension - Black
			<b>2P+E plugs - 16 A and extensions with rings - plastic</b>
	Bulk	Gencod labelling	3 x 2.5 mm <sup>2</sup> max. cable, screw cable grip
25	0 503 24	0 501 92	● Plug - Grey
10	0 503 25	0 501 93	● Extension - Grey
25	0 503 30	0 501 90	○ Plug - White
10	0 503 31	0 501 91	○ Extension - White
25	0 503 28	0 501 94	● Plug - Black
10	0 503 29	0 501 95	● Extension - Black
			<b>2P+E extension - 16 A - plastic - side outlet</b>
	Sleeve		○ White/Grey Removable accessory packaging enabling attachment
4	0 501 99		
			<b>2P+E plugs - 16 A - easy extraction - plastic</b>
	Gencod labelling		System enabling extraction of sockets thanks to the lever-extractor 3 x 1.5 mm <sup>2</sup> max. cable, screw cable grip, side outlet
5	0 501 75		○ White
5	0 501 76		● Black and Grey
			<b>2P+E plugs - 16 A - cable orientation - plastic</b>
	Gencod labelling		3 x 0.5 mm <sup>2</sup> max. cable, screw cable grip. Enables the cable to be moved to 360°
10	0 501 72		○ White
10	0 501 73		● Black and Grey

## German standard multi-socket plugs and extensions



0 506 56



0 503 77

Pack	Cat.Nos	2P multi-socket plugs - 6 A
10	Cardboard 0 506 50	For connection onto 2P+E socket Max. admissible power: 3.680 W at 230 V~ <b>4 side outlets</b> ○ White ● Black
10	0 506 51	
10	Sleeve 0 506 55	Max. admissible power 3.680 W at 230 V~ <b>2 front outlets</b> ○ White/Grey <b>3 front outlets</b> ○ White/Grey <b>2 side outlets</b> With extraction button for easy disconnection of the plugs ○ White/Grey
10	0 506 56	
5	Cardboard 0 506 65	<b>3 side outlets</b> ○ White ○ Transparent
10	0 506 62	
10	0 506 63	
5	0 503 77	<b>Multi-socket "octopus" extension leads ready to use - rubber</b> ● Black - 2P+E - 16 A - IK 10 With 1 plug and 3 extensions H07 RNF 3G 1.5 and 2.5 mm <sup>2</sup> cable Length: 0.8 m

## German standard multi-outlet extensions without cord



6 946 29



6 950 09

Pack	Cat.Nos	Multi-outlet extensions for comfort without cord
5	6 946 24	Sockets with child protection shutters tested to withstand 10000 operations Orientable socket outlets To be equipped with flexible cable of 3G 1.5 mm <sup>2</sup> or 3G 1mm <sup>2</sup> minimum On/off switch with a light indicator, can be operated by foot or by hand Maximum space between 2 sockets to connect transformers, chargers, etc. Direct wall-mounting possibilities (with screws) Possibility to manage the cable around the feet Supplied with self-gripping tie for grouping the cords of the connected devices 16 A max. power 3500 W at 230 V
5	6 946 29	
5	6 946 34	
5	6 946 39	
5	6 946 39	
10	6 950 04	<b>Standard multi-outlet extensions without cord</b> To connect several devices equipped with plugs with or without earth: appliances class I (simple insulation) or class II (double insulation), lamps, PC, TV, stereo, etc. Ultra-flat: can be slid underneath furniture Wall-mounting possibilities with the packaging accessory 90° socket for connecting a transformer without blocking another socket 16 A max. power 3500 W at 230 V To be equipped with flexible cable of 3G 1.5 mm <sup>2</sup> or 3G 1mm <sup>2</sup> minimum
10	6 950 09	
10	6 950 14	
10	6 950 19	

# MULTI-OUTLET MULTIMEDIA EXTENSIONS

## **N** Effective protection for all electrical and electronic



### ■ Vertical multi-outlet extension with voltage surge protector

- 4 x 2P+E controlled by main switch
  - 2 USB charger sockets on base
  - 1 micro-USB connector on base.
- Ideal on a desk for charging all mobile devices: tablets, MP3 and MP4 players, smartphones, etc.



### ■ Multi-outlet extension with voltage surge protector

- 4 x 2P+E controlled by main switch
- 2 x 2P+E permanently supplied
- 2 x RJ 45
- 2 TV sockets



### ■ Multi-outlet extension with voltage surge protector

- 4 x 2P+E controlled by main switch
- 2 x RJ 45

## German standard multi-outlet extensions - with cord



6 946 64



6 946 66



6 946 14

Pack	Cat.Nos	Multi-outlet extensions for multimedia with voltage surge protector
5	6 946 64	<p>Protection of electrical and electronic devices and the telephone circuit against lightning and overvoltages With indicator showing the status of the voltage surge protector (on: devices protected; off: voltage surge protector not operational, extension needs to be replaced) Sockets with safety shutters tested to withstand 10,000 operations With switch with indicator for controlling up to 3 switching mode power supplies (for example, computing device) Optimum space between 2 sockets for plugging in transformers, chargers, etc. 16 A, max. power 3500 W at 250 V Supplied with self-gripping cable tie for grouping cords together Ideal for total protection of an Internet box RJ 45 connectors compatible with RJ 11 ADSL compatible RJ 45/RJ 11 I/O: Uc: 200 V, Uoc: 2 kV and Up: 600 V</p>
5	6 946 66	<p>White/Grey 4 x 2P+E + 2 x RJ 45 4 x 2P+E controlled by main switch Block of sockets pivoting on its axis Can be screwed onto a wall, an item of furniture, a work surface, etc. Power supply cord 1.5 m (3G 1.5 mm<sup>2</sup>) Supplied with 1.5 m RJ 11 cord for telephone socket</p>
1	6 946 14	<p>Black 6 x 2P+E + 2 x RJ 45 + 2 x TV sockets 4 x 2P+E controlled by main switch 2 x 2P+E permanently supplied Block of sockets pivoting on its axis Can be screwed onto a wall, an item of furniture, a work surface, etc. Power supply cord 1.5 m (3G 1.5 mm<sup>2</sup>) Supplied with 1.5 m RJ 11 cord for telephone socket and with 1.8 m coaxial TV cord (plug Ø 9.52 mm)</p>
		<p>White/Grey 4 x 2P+E + 1 socket with 2 USB charger sockets + 1 micro-USB connector 4 x 2P+E controlled by main switch Vertical block of sockets pivoting on its axis 5 V/1000 mA USB charger sockets for charging tablets, MP3 or MP4 players, mobile phones, etc. Micro-USB connector for charging smartphones directly on the socket Power supply cord 2 m (3G 1.5 mm<sup>2</sup>)</p>



DIN rail mounting voltage surge protectors  
**See p. 64**



## German standard multi-outlet extensions

with cord (continued)



Pack	Cat.Nos	Multi-outlet extensions for comfort and safety
		<p>On/off switch with a light indicator, can be operated by foot or by hand</p> <p>Orientable socket outlets</p> <p>Sockets with child protection shutters tested to withstand 10000 operations</p> <p>Maximum space between 2 sockets to connect transfos, chargers, etc.</p> <p>Direct wall-mounting possibilities (with screws)</p> <p>With power supply cord (3G 1.5 mm<sup>2</sup>)</p> <p>Possibility to manage the cable around the feet</p> <p>Supplied with self-gripping tie for grouping the cords of the connected devices</p> <p>Important: Multi-outlet extensions should always be installed together with modular voltage surge protectors at the main board</p> <p><b>With power consumed indicator (safe control)</b></p> <p>Equipped with:</p> <ul style="list-style-type: none"> <li>- an indicator showing the power consumed by the connected devices (max. 3500 W)</li> <li>- safety circuit-breaker that automatically shuts down the power if maximum power is exceeded</li> </ul> <p>With manual reset</p>
5	6 946 41	4 x 2P + $\perp$ - 1.5 m cord
5	6 946 43	4 x 2P + $\perp$ - 3 m cord
5	6 946 46	6 x 2P + $\perp$ - 1.5 m cord
5	6 946 47	6 x 2P + $\perp$ - 3 m cord
		<p><b>With voltage surge protector</b></p> <p>For protection of electrical and electronic devices (TV, stereo, PC, etc.) against lightning and overvoltages</p> <p>With an indicator showing the protection status (On: devices protected, Off: voltage surge protection inactive, need to replace the extension)</p>
5	6 946 51	4 x 2P + $\perp$ - 1.5 m cord
5	6 946 56	6 x 2P + $\perp$ - 1.5 m cord
		<p><b>With masters slave function</b></p> <p>Equipped with:</p> <ul style="list-style-type: none"> <li>- 1 master socket</li> <li>- 4 slave sockets</li> <li>- 1 uncontrolled socket</li> </ul> <p>- voltage surge protector with thermic protection</p>
5	6 946 48	6 x 2P + $\perp$ - 1.5 m cord
		<p>Plug your TV in the master socket</p> <p>Plug your DVD player, console game, loudspeakers, amplifiers, etc, in the slave sockets</p> <p>When you turn on the TV, all the slave sockets get power and turn on the plugged devices</p> <p>When you turn off the TV (info standby mode or completely off), the multi outlet - extension switches off the power of the slave sockets</p> <p>The uncontrolled socket can be used continuously (for alarm clock, ADSL box, etc.)</p>

Pack	Cat.Nos	Multi-outlet extensions for comfort
		<p>On/off switch with a light indicator, can be operated by foot or by hand</p> <p>Socket with child protection shutters tested to withstand 10000 operations</p> <p>Orientable socket outlets</p> <p>Maximum space between 2 sockets to connect transfos, chargers, etc.</p> <p>Supplied with self-gripping tie for grouping the cords of the connected devices</p> <p>Direct wall-mounting possibilities (with screws)</p> <p>Cable management possible around the wall-mounting fixtures</p> <p>With power supply cord 1.5 m (3G 1.5 mm<sup>2</sup>) or 3 m (3G 1.5 mm<sup>2</sup>)</p> <p>16 A max. power 3500 W at 230 V</p>
5	6 946 21	3 x 2P+ $\perp$ - 1.5 m cord
5	6 946 26	4 x 2P+ $\perp$ - 1.5 m cord
5	6 946 36	6 x 2P+ $\perp$ - 1.5 m cord
		<p><b>3 m cord</b></p>
5	6 946 22	3 x 2P+ $\perp$ - 3 m cord
5	6 946 27	4 x 2P+ $\perp$ - 3 m cord
5	6 946 37	6 x 2P+ $\perp$ - 3 m cord

Pack	Cat.Nos	Standard multi-outlet extensions
		<p>To connect several devices equipped with plugs with or without earth: appliances class I (simple insulation) or class II (double insulation), lamps, PC, TV, stereo, etc.</p> <p>Ultra-flat: can be slid underneath furniture</p> <p>Wall-mounting possibilities with the packaging accessory</p> <p>90° socket for connecting a transformer without blocking another socket</p> <p>Power supply cord 1.5 m (3G 1.5 mm<sup>2</sup>) or 3 m (3G 1.5 mm<sup>2</sup>) or 5 m (3G 1.5 mm<sup>2</sup>)</p> <p>16 A max. power 3 500 W at 230 V</p>
		<p><b>1.5 m cord</b></p>
10	6 950 01	3 x 2P+ $\perp$
10	6 950 06	4 x 2P+ $\perp$
10	6 950 16	6 x 2P+ $\perp$
		<p><b>3 m cord</b></p>
10	6 950 02	3 x 2P+ $\perp$
10	6 950 07	4 x 2P+ $\perp$
10	6 950 17	6 x 2P+ $\perp$
		<p><b>5 m cord</b></p>
10	6 950 03	3 x 2P+ $\perp$
10	6 950 08	4 x 2P+ $\perp$
10	6 950 18	6 x 2P+ $\perp$

## Multi-outlet extensions

### Example of use

Possibilities to orientate socket outlets



Possibilities of direct wall-mounting



Optimum space between 2 sockets to connect transfos, chargers



### Characteristics

#### Safe control

Safe control indicates the power consumed and automatically shuts off the power if maximum power is exceeded



#### Voltage surge protector

an indicator shows the protection status



## German standard cable reels and inspection lamps



0 507 67



0 622 41

Conform to EN 61 242 A 11  
3000 W - 230 V~ (cable entirely unrolled) with thermal switch protection (manually resettable)

Pack	Cat.Nos	Cable reels for on-site use
		Intensive use - IP 44 - IK 08 Plastic structure Suspended from the wall and on a ladder Drum mounted on ball bearing winding for easy cable winding With child protection shutters
1	0 507 67	25 m - 3G 1.5 mm <sup>2</sup>
1	0 507 69	25 m - 3G 2.5 mm <sup>2</sup>
		<b>Fluorescent inspection lamps</b>
		<b>IP 64 - IK 09</b> Supplied with fluorescent tube Class II 5 m cable H05 RNF (2 x 1 mm <sup>2</sup> )
1	0 622 40	8 W - 230 V - with 2P - 10/16 A plug G5 lampholder
1	0 622 41	11 W - 230 V - with 2P - 10/16 A plug
		<b>IP 55</b> With hook - Rubber handle supplied with fluorescent tube, 2G7 lampholder
1	0 622 32	11 W - 230 V with 2P plug - 16 A 10 m cable - Class II
1	0 622 33	11 W - 24 V with Hypra plug 10 m cable - Class III



Pack	Cat.Nos	E 27 lampholder
50	0 601 21	Insulating material - 100 W Screw connection Threaded base - single bushing 10 mm connector With retaining screw 4 A - 250 V~
10	0 601 30	<b>Lampholders for public lighting</b> Porcelain - white Base retaining clip, protective skirt 4 A - 250 V~ E 27 lampholder
10	0 601 80	Base retaining clip - 16 A max. One piece unit 16 A - 750 V~ E 40 lampholder
20	0 401 87	<b>Cord switches</b> <b>Fluorescent</b> Easy connection by cutting the 2 wires Double pole White spotted
20	0 401 92	<b>Coloured</b> Easy connection by cutting the 2 wires Double pole White
20	0 401 93	Old gold, old gold rocker
20	0 401 94	Black
10	0 401 75	<b>Door contact switch</b> Normally closed contactor complete with roller actuator Automatically illuminates cupboards upon opening of the door Single pole 2 A - 250 V



Pack	Cat.Nos	Incandescent shaverlight - British standard
1	6 915 06	Conform to BS EN 60598 and IEE wiring regulations (16th edition) For linear incandescent tube, Ø25 mm, length 284 mm Polycarbonate diffuser Pull cord switch in front + 2P socket protected by a 20 VA transformer Supplied without lamp Incandescent shaverlight IP 24 - IK 04
1	0 606 31	<b>Fluorescent shaverlight - French standard</b> <b>IP 24 - IK 04 - class II</b> Switched 2G7 - 11 W - 900 lm
1	0 606 37	<b>IP 41 - IK 04 - class II</b> Striplight + ECO 1 detection - IR 180° - Detection field 15 m <sup>2</sup> G5 - 24 W - 1750 lm
1	0 606 32	<b>IP 44 - IK 04 - class II</b> With shaver socket with transformer 2G11 - 18 W - 1200 lm
10	0 606 20	<b>Halogen shaverlight - French standard</b> Supplied with halogen tube Replace old striplights easily with their wide sockets Opal diffuser for better distribution of the luminous flux Equipped with an automatic switch-off system when the diffuser is removed, for increased safety IK 04 Glow wire resistance 750°C 30 sec. Base pre-cut for easy combination with the mini-trunking <b>IP 24 - class II</b> Supplied with base Unswitched
10	0 606 21	Switched
10	0 606 28	Switched + 2P socket + transformer 230/20 VA
10	0 606 25	<b>IP 21 - class I</b> Switched with 2P+⊥ socket

## Chimes



## Bells, bell pushes



### Pack Cat.Nos Surface-mounting radio-controlled chimes

1	0 416 13	<b>230 V chime kit</b> Composition: - weatherproof push-button - receiver Choice of 15 melodies 433 MHz - Range 100 m Configuration via switch to avoid interference
1	0 416 10	<b>8 V chime kit with light indicator</b> Composition: - weatherproof push-button - receiver Choice of 36 melodies 3 adjustable sound levels - Range 100 m 2 x 1.5 V AA alkaline batteries (not included) Preset configuration Wall and table mounting Possibility to connect 4 push-buttons
1	0 416 11	<b>8 V chime kit</b> Composition: - weatherproof push-button - receiver Choice of 36 melodies 2 x 1.5 V AA alkaline batteries (not included) Preset configuration Range 100 m Wall mounting
1	0 416 17	<b>Radio controlled push-button</b> Additional push-button for Cat.No 0 416 10
<b>Electromechanical chimes</b> White Dim.: 116 x 116 x 48 mm Tone level: 80 dB at 1 m		
1	0 416 50	<b>8-12 V~ chime</b> Compatible with non-illuminated push-button Cat.No 0 416 46 or illuminated push-buttons Cat.Nos 0 416 45/47 Use a 8 VA transformer Cat.No 0 042 25 or 0 420 25
1	0 416 51	<b>230 V~ chime</b> 2 note chime - 50/60 Hz Compatible with illuminated push-button Cat.No 0 416 45
1	0 416 52	<b>230 V~ chime with transformer</b> 50/60 Hz with built-in 8-12 V transformer Class II Compatible with non-illuminated push-button Cat.No 0 416 46 or illuminated push-buttons Cat.Nos 0 416 45/47

### Pack Cat.Nos Bell pushes

5	0 416 46	Surface-mounting White Supplied without fixing screws <b>24 V - 2 A bell push</b> IP 30 - class III W Dim.: 50 x 25 x 20 mm						
10	0 416 45	<b>230 V - 2 A bell push with illuminated label holder</b> IP 30 - class II Supplied without lamp Dim.: 70 x 35 x 24 mm Use lamps Cat.No 0 898 26 - 12 V and Cat.No 0 898 21 - 220 V						
10	0 416 47	<b>24 V - 2 A universal - bell push with label holder</b> Weatherproof IP 44 (IK 07) - Class III W Dim.: 70 x 70 x 25 mm Illuminated with lamp Cat.No 0 898 26 Can be used with any type of chimes (electronic or electromechanical)						
<b>Lido bells</b> IP 20 - IK 04 Average acoustic output at 1 m: 80 dB at 1 m Surface-mounting with screws with levelling facilities								
<b>Class II</b> (double insulated)								
10	0 412 21	230 V~ - 50/60 Hz Dim.: 95 x 61 x 33 mm						
1	0 412 43	<b>With built-in transformer</b> 230 V~ - 50/60 Hz Dim.: 135 x 88 x 48 mm Warning: take lamps out of the bell pushes						
		<table border="1"> <thead> <tr> <th>Consumption (mA)</th> <th>Average acoustic output at 1 m in dB</th> </tr> </thead> <tbody> <tr> <td>30</td> <td>80</td> </tr> <tr> <td>45</td> <td>80</td> </tr> </tbody> </table>	Consumption (mA)	Average acoustic output at 1 m in dB	30	80	45	80
Consumption (mA)	Average acoustic output at 1 m in dB							
30	80							
45	80							



## Colour video door entry kit

1 apartment - 2-wires



3 693 10 : Complete video kit - black



3 692 00 : Complete video kit - white

2-wires colour video hands free kit with wall mounted surface-mounting street panel (with rainshield included)  
The kit can be expanded with up to 3 dedicated hands free internal units

### Pack Cat.Nos 7" colour touch screen video kits

Pack	Cat.Nos	7" colour touch screen video kits
		<b>Complete video kits</b>
		Composition:
		- 1 metal street panel (entrance) with colour camera and LED for the illumination of the field of view
		- 1 hands free touch screen colour display 7" with audio and picture memory, MP3 melodies and plug in power supply included (Euro plug standard)
1	3 693 00	White
1	3 693 10	Black
		<b>Additional video internal units</b>
1	3 693 05	White
1	3 693 15	Black

Pack	Cat.Nos	7" colour video kits
		<b>Complete video kits</b>
		Composition:
		- 1 metal street panel (entrance) with colour camera and LED for the illumination of the field of view
		- 1 hands free colour display 7" with plug in power supply included (Euro plug standard)
1	3 692 00	White
1	3 692 10	Black
		<b>Additional video internal units</b>
1	3 692 05	White
1	3 692 15	Black

Pack	Cat.Nos	3.5" colour video kits
		<b>Complete video kits</b>
		Composition:
		- 1 metal street panel (entrance) with colour camera and LED for the illumination of the field of view
		- 1 hands free colour display 3.5" with plug in power supply included (Euro plug standard)
1	3 691 00	Grey
		<b>Additional video internal unit</b>
1	3 691 05	Grey

## Colour video door entry kit

wiring diagrams

### 7" colour and 7" colour touch screen video kits

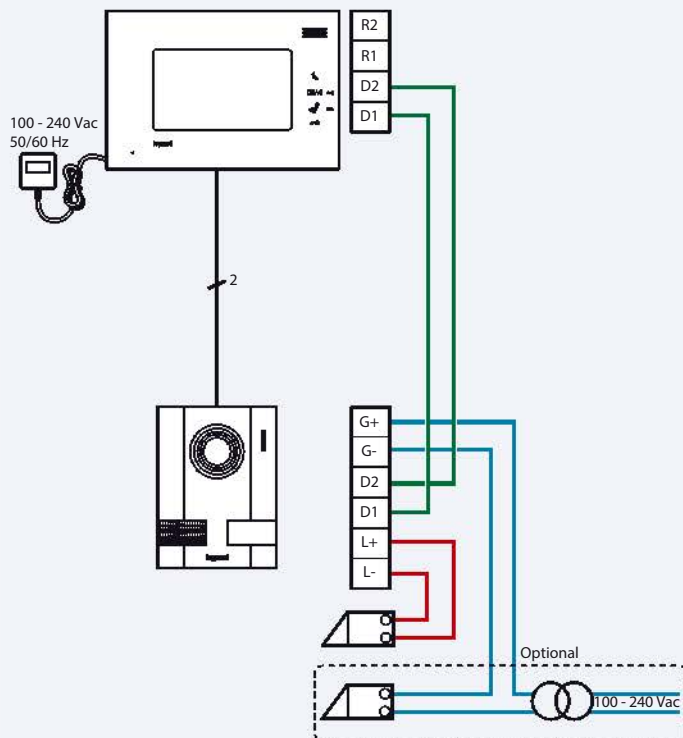

#### Cables specifications

2 x 0.5 mm <sup>2</sup>	2 x 1 mm <sup>2</sup>	2 x 1.5 mm <sup>2</sup>
0 - 50 m	0 - 75 m	0 - 100 m

### 3.5" colour video kits

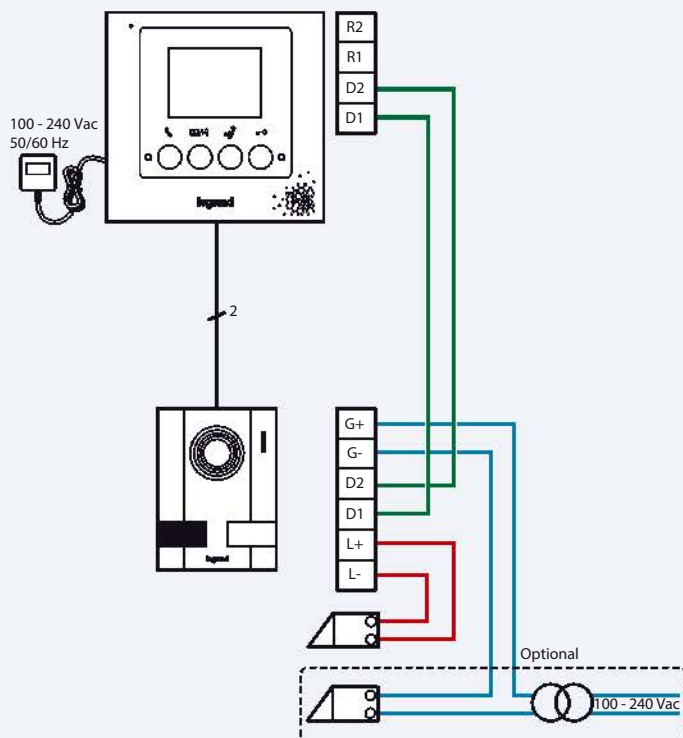

#### Cables specifications

2 x 0.5 mm <sup>2</sup>	2 x 1 mm <sup>2</sup>	2 x 1.5 mm <sup>2</sup>
0 - 50 m	0 - 75 m	0 - 100 m



## Colour video door entry kit

1 apartment - 4-wires



3 690 83 : Complete video kit



3 690 73 : Complete video kit

Surface-mounting street panel  
4 wires (+ 2 to open the gate)  
The monitor allows surveillance and opening of the gate  
The system allows 2 additional monitors, with intercom function

Pack	Cat.Nos	7" colour video kits - hands free
1	3 690 80	<b>German standard</b> Complete video kit Composition: - 1 metal street panel (entrance) with LEDs - 1 colour 7" monitor with integrated power supply and German standard plug and cable - 1 wall-mounting base - 1 set of screws for wall fixing
1	3 690 85	Additional video internal unit
1	3 690 83	<b>British standard</b> Complete video kit Composition: - 1 metal street panel (entrance) with LEDs - 1 colour 7" monitor with integrated power supply and British standard plug and cable - 1 wall-mounting base - 1 set of screws for wall fixing
1	3 690 88	Additional video internal unit
<b>3.5" colour video kits - with handset</b>		
1	3 690 70	<b>German standard</b> Complete video kit Composition: - 1 metal street panel (entrance) with LEDs - 1 colour 3.5" monitor with integrated power supply and German standard plug and cable - 1 wall-mounting base - 1 set of screws for wall fixing
1	3 690 75	Additional video internal unit
1	3 690 73	<b>British standard</b> Complete video kit Composition: - 1 metal street panel (entrance) with LEDs - 1 colour 3.5" monitor with integrated power supply and British standard plug and cable - 1 wall-mounting base - 1 set of screws for wall fixing
1	3 690 78	Additional video internal unit

## Colour video door entry kit

wiring diagrams

### Colour screen analog video kit - Hands free

\* Optional

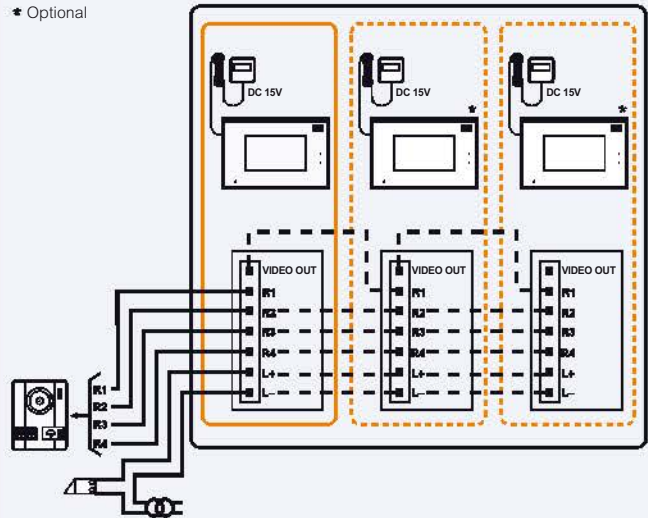

### Colour screen analog video kit - with handset

\* Optional

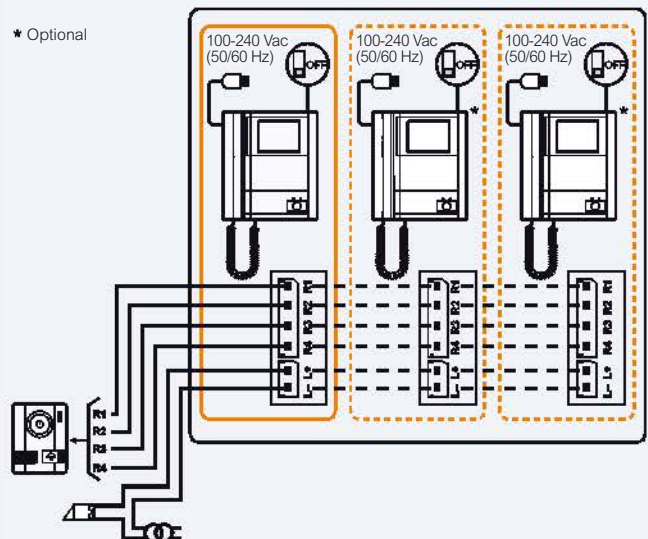

## Audio door entry kit with handset

1 apartment - 4-wires



Surface-mounting street panel  
 2 wires (+ 2 to open the gate)  
 Opening of gate with handset  
 The system allows 2 additional audio internal units  
 Can be used as intercom within the house

Pack	Cat.Nos	German standard
1	3 690 00	Complete audio kit Composition: - 1 slim street panel (entrance) - 1 audio handset with transformer equipped with German standard plug - 1 set of screws for wall fixing
1	3 690 05	Additional audio internal unit with transformer equipped with German standard plug
British standard		
1	3 690 03	Complete audio kit Composition: - 1 slim street panel (entrance) - 1 audio handset with transformer equipped with British standard plug - 1 set of screws for wall fixing
1	3 690 08	Additional audio internal unit with transformer equipped with British standard plug

## Audio door entry kit with handset

wiring diagram

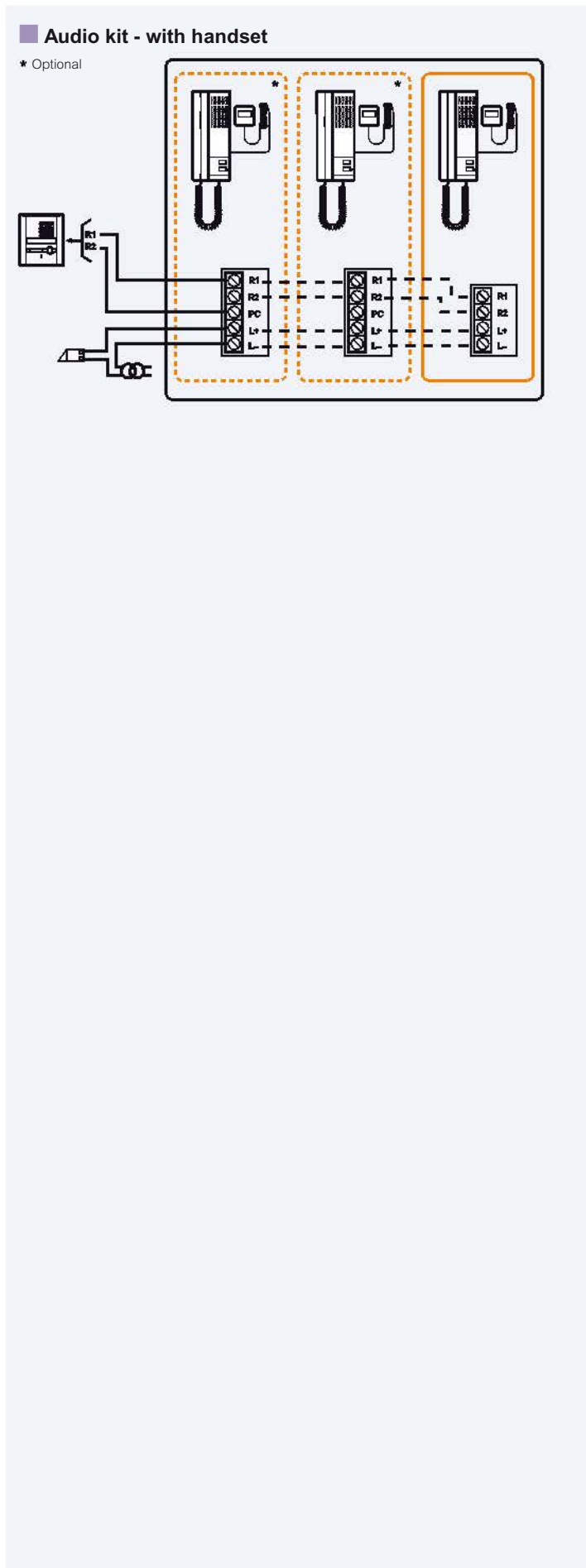



# New Sfera

two personalities

## one electronic heart up to 3900 apartment

From standard and vandal resistant entrance panels and handsets through to home automation control units

### SFERA NEW SLIM PROFILE

- From IP 54 up to IK 08
- Calls from push-buttons to address book

### SFERA ROBUR INCREASED SAFETY

- Vandal resistant IP 54 up to IK 10
- Slim profile



Allwhite

Allmetal

Allstreet

Sfera Robur

### 12 FUNCTIONS MODULES NUMEROUS COMBINATIONS

#### ■ Traditional functions

#### ■ Specialist functions



Basic speaker module



Audio video module



Display module



A/V module with wide angle camera



Night & Day and wide angle camera module



Inductive loop and control speech synthesis module

### 2 WIRE SIMPLICITY WITH MAXIMUM PERFORMANCE



- Ideal for upgrading or refurbishment
- The 2 wire technology gives the possibility of turning an audio system into a colour video system without need for



More information [www.doclegrand.com](http://www.doclegrand.com)



Also available D45 system up to 4000 apartments on [www.doclegrand.com](http://www.doclegrand.com)



0 419 11



0 419 12

Pack	Cat.Nos	Movement detectors
1	0 419 11	<p><b>Infrared detector</b>                      Electrical power 230 V~ - 50/60 Hz - class II                      IP 31 - IK 05                      Possibility to connect one or several detectors with one or several electromechanical chimes (3 maxi) Cat.Nos 0 416 06/26                      Adjustable time between 2 detections: 7 seconds</p>
1	0 419 12	<p><b>Optical barrier</b>                      Electrical power 24 to 230 V~ - 50/60 Hz - class II                      IP 67 - IK 08                      Compatible with all electronic wired chimes and Legrand bell                      Adjustable time between 2 detections: 7 seconds                      Supplied with reflector and fixing brackets</p>
10	0 419 00	<p><b>Door contact</b>                      Class III ⚡                      Recessed contact - normally closed when door open and open when door closed</p>

## Infrared movement detector Cat.No 0 419 11

Horizontal installation

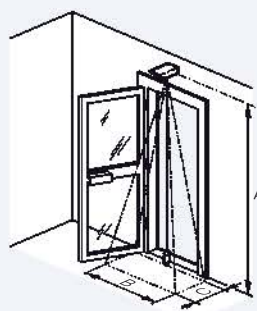

A	2.5 m	3 m	4.5 m
B	1 m	1.2 m	2 m
C	0.4 m	0.5 m	0.7 m

Vertical installation

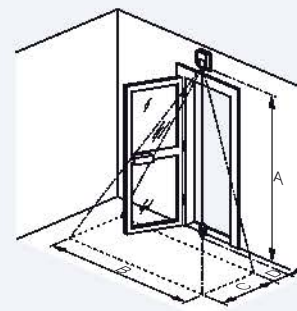

A	2.5 m	3 m	4.5 m
B	2.2 m	2.6 m	3.9 m
C	0.85 m	1 m	1.55 m
D	0.25 m	0.3 m	0.45 m

## Optical barrier detector Cat.No 0 419 12

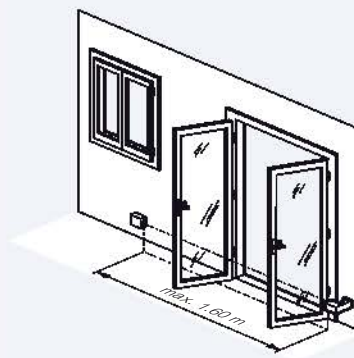

## Door contact Cat.No 0 419 00

Chimes control SELV, bell or light (30 V max)

Recessed contact  
 Cat.No 0 419 00

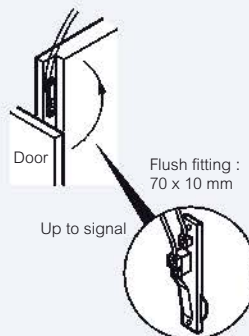

# Technical alarm detectors for domestic premises

smoke alarm detectors, monoxide alarm detector, accessories



0 405 27



0 405 28



0 405 10

Pack	Cat.Nos	Stand alone smoke alarm detector
1	0 405 27	<p>Detects the smoke                      Conform to EN 14604, CE CPR and NF DAAF approved (by AFNOR certification)                      Photoelectric technology guarantee without radioelement                      Gives a loud signal: 85 dB at 3 meters                      Powered by lithium battery (lifetime: 10 years, not replaceable)                      Life cycle of 10 years: Due date indicated on the product                      Fitted with:</p> <ul style="list-style-type: none"> <li>- "hush function" : in case of false alarm permit to stop the alarm sound for 10 minutes</li> <li>- grid insect protection (to avoid false alarm)</li> <li>- "anti-theft function" (suitable for rental housing – a tool is necessary to take off the detector)</li> </ul> <p>Delivered with screws and battery                      Made in France</p>
1	0 405 28	<p><b>Wireless interconnectable smoke alarm detector</b></p> <p>Detects the smoke                      Conform to EN 14604 and CE CPR and NF DAAF approved (by AFNOR certification)                      Photoelectric technology guarantee without radioelement                      Gives a loud signal – 85 dB at 3 meters                      Powered by lithium battery (lifetime: 10 years, not replaceable)                      Life cycle of 10 years: Due date indicated on the product                      Can be interconnectable with 10 devices                      - Cat.No 0 405 28 (smoke alarm detector) or                      - Cat.No 0 405 29 (carbon monoxide alarm detector) or                      - Cat.No 0 405 14 (relay)                      When one device detects, all interconnectable devices go into alarm                      Can be interconnectable with My Home intruder alarm                      Suitable for housing with more one floor or more one device                      Fitted with:</p> <ul style="list-style-type: none"> <li>- "hush function" : in case of false alarm permit to stop the alarm sound for 10 minutes</li> <li>- grid insect protection (to avoid false alarm)</li> <li>- "anti-theft function" (suitable for rental housing – a tool is necessary to take off the detector)</li> </ul> <p>Delivered with screws and battery                      Made in France</p>

Pack	Cat.Nos	Wireless interconnectable carbon monoxide alarm detector
1	0 405 29	<p>Detects a concentration of carbon monoxide above 58 ppm                      Conform to EN 50291-1 and NF DAAF approved (by AFNOR certification)                      Electrochemical sensor                      Gives a loud signal – 85 dB at 1 meter                      Powered by lithium battery (lifetime: 7 years, not replaceable)                      Life cycle of 7 years: Due date indicated on the product                      Can be interconnectable with 10 devices:                      - Cat.No 0 405 28 (smoke alarm detector) or                      - Cat.No 0 405 29 (carbon monoxide alarm detector) or                      - Cat.No 0 405 14 (relay)                      When one device detects, all interconnectable devices go into alarm                      Suitable for housing with more one floor or more one device                      Delivered with screws and battery                      Made in France</p>
1	0 405 14	<p><b>Wireless interconnectable relay</b></p> <p>Change state upon detection of one of the interconnectable devices Cat.No 0 405 28 or Cat.No 0 405 29                      Breaking capacity: 1 A - 30 V                      Voltage range: 6 - 18 Vcc                      External back up power supply (not included)                      Can be interconnectable with 10 devices:                      - Cat.No 0 405 28 (smoke alarm detector) or                      - Cat.No 0 405 29 (carbon monoxide alarm detector)                      When one device detects, all interconnectable devices go into alarm                      Suitable to improve the housing safety                      Can be linked to flash to indicate the alarm condition to a deaf person, can send the alarm information on a telephone transmitter, can switch on the light to exit easier, can be linked to the home automation.                      Made in France</p>
1	0 405 10	<p><b>Self-contained sounder beacon</b></p> <p>2 – 75 cd                      Technology led: white color                      Power supply: 230V – battery rescued 72H                      Sound &lt; 60 dB                      Flash: Dimmable flash from 2 to 150 cd                      Suitable for deaf person                      Supplied with batteries                      Made in France</p>

# LIGHTING MANAGEMENT, EMERGENCY LIGHTING, ACCESS CONTROL & CCTV

## Lighting management & indoor/outdoor lighting



**P. 592**  
Motion sensors  
for 1 circuit



**P. 599**  
Lighting  
Management  
BUS/SCS

## Emergency lighting



**P. 606**  
U34<sup>LED</sup> indoor  
emergency  
lighting  
luminaire



**P. 616**  
Safety portable  
lamp, spare parts  
and labels

## Access control & CCTV



**P. 621**  
Stand-alone  
indoor and  
outdoor access  
control kits



**P. 627**  
Centralised  
controller,  
accessories and  
power supplies



**P. 642**  
IP cameras

## NEW PRODUCTS 2014



**URA ONE,  
U21<sup>LED</sup> units**  
- indoor LED  
maintained and non  
maintained units  
- high power LEDs  
(p. 608 and 609)



**B65<sup>LED</sup> units**  
- weatherproof LED  
maintained and non  
maintained units  
- plug-in base  
(p. 612)



**P. 594**  
Lighting Management sensors for 1 circuit



**P. 596**  
Configuration tools and accessories



**P. 597**  
Controllers



**P. 598**  
Lighting Management sensors for several circuits



**P. 602**  
Weatherproof and vandal-resistant bulkhead lights



**NEW**  
**P. 608**  
URA ONE indoor self-contained emergency lighting luminaire



**NEW**  
**P. 609**  
U21<sup>LED</sup> and U21<sup>NEW</sup> indoor emergency lighting luminaire



**NEW**  
**P. 611**  
INOX<sup>LED</sup>, B66<sup>LED</sup>, B65<sup>LED</sup> and B65<sup>NEW</sup> weatherproof emergency lighting luminaire



**P. 614**  
S8 and B66 BS-compliant indoor standard emergency lighting luminaire



**P. 618**  
LVS2 addressable & monitoring system



**P. 620**  
Power packs



**P. 622**  
Stand-alone keypads and badge readers



**P. 623**  
Stand-alone biometric readers, energy saver units and badges



**P. 625**  
Centralised keypads



**P. 626**  
Centralised badge readers and biometric readers



**NEW**  
**P. 628**  
Smart Security system



**NEW**  
**P. 636**  
7" and 17" CCTV kits



**P. 638**  
Analog cameras



**P. 641**  
Analog DVRs



**P. 645**  
IP Network Video Recorders



**P. 646**  
CCTV video monitors



**P. 649**  
Fire detection, alarm panels, sounders and safety boxes























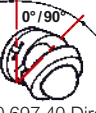































## Smart Security system

solution to manage access control, CCTV, intruder alarm and technical alarm functions  
**(p. 628)**

# Motion and Lighting Management sensors for 1 circuit

## selection chart

MOTION SENSORS				
AREAS WITHOUT NATURAL LIGHT	INSTALLATION			
	Ceiling 	Surface-mounting <sup>(2)</sup>	Wall 	
			Mosaic	Arteor
<b>PASSAGE AREAS</b>				
Hall / lobby Stairways / hallways Storage areas / technical areas	 0 488 03 <sup>(1)</sup> 	 0 489 11 	 8 m With neutral: 0 784 54 Without neutral: 0 784 55 <sup>(4)</sup> Without neutral, for time-lag switch: 0 784 57	 8 m With neutral: 5 740 47 Without neutral: 5 740 34 <sup>(4)</sup>
<b>OUTDOOR AND HUMID AREAS</b>				
Internal/external parking lot Internal entrance areas	IP 55  0 697 40 / 0 697 80 	 0 489 31 Fixed head   0° / 90° 0 697 40 Directional head 		
<b>LIGHTING MANAGEMENT SENSORS</b>				
AREAS WITH NATURAL LIGHT	Automatic On-Off / Checking permanently the presence and day-light level			
<b>WORKING AREAS</b>				
Individual office / small room	 0 488 00 / 0 488 04 <sup>(3)</sup> 	 0 489 14 	 8 m With neutral: 0 784 52 Without neutral: 0 784 53	 8 m With neutral: 5 740 49 Without neutral: 5 740 31
Open space / classroom / meeting room	 0 488 06 <sup>(1)</sup> / 0 488 09 	 0 489 16 <sup>(3)</sup> 	 8 m With neutral: 0 784 52 Without neutral: 0 784 53	 8 m With neutral: 5 740 49 Without neutral: 5 740 31
<b>PASSAGE AREAS</b>				
Hall / lobby Stairways / hallways	 0 488 07 <sup>(1)</sup> / 0 488 08 <sup>(1)</sup> 	 0 489 17 <sup>(3)</sup> 	 8 m With neutral: 0 784 54 Without neutral: 0 784 55 <sup>(4)</sup> Without neutral, for time-lag switch: 0 784 57	 8 m With neutral: 5 740 47 Without neutral: 5 740 34 <sup>(4)</sup>
Hallways Very long areas	 0 488 17 <sup>(1)</sup> 2 x 12 m 	 0 489 17 <sup>(3)</sup> 20 m 	 8 m With neutral: 0 784 54 Without neutral: 0 784 55 <sup>(4)</sup>	 8 m With neutral: 5 740 47 Without neutral: 5 740 34 <sup>(4)</sup>
High ceiling areas (gymnasium, storage areas...)	IP 55  0 489 32 (Flush-mounting) 10 m fixing height Ø 25 m 	 0 489 33 270° 20 m 		
Restrooms, bathrooms Dressing room	 0 488 04 <sup>(3)</sup> 	 0 489 16 <sup>(3)</sup> 8 m 	 8 m With neutral: 0 784 54 Without neutral: 0 784 55 <sup>(4)</sup>	 8 m With neutral: 5 740 47 Without neutral: 5 740 34 <sup>(4)</sup>
<b>OUTSIDE &amp; HUMID AREAS</b>				
Internal/outside parking lot Internal entrance areas	IP 55  0 489 32   270° 20 m 0 489 33 Directional head	 0 489 33 Directional head 270° 20 m 		

1: Surface-mounting box option - 2: angle mounting option - 3: 1 lighting output + 1 fan output - 4: Retro-fit dedicated solution



# Lighting Management sensors and room controllers for multiple circuits control

## selection chart

CHOOSE THE SENSOR...

Automatic On-Off  
Checking permanently the presence and the light level

### INSTALLATION

Ceiling

Wall

Surface-mounting

Flush-mounting<sup>(1)</sup>

Mosaic

Arteor

WORKING AREAS		Ceiling		Surface-mounting		Wall	
		Ø 8 m		5 m		8 m	
Individual office Classroom	0 488 22						
PASSAGE AREAS		Ø 8 m		5 m		8 m	
Restrooms, changing rooms...	0 488 20						
Hallways Very long areas	0 488 20					-	-
High ceiling areas (gymnasium, storage area...)	-	-	-			-	-
OUTSIDE & HUMID AREAS		Ø 8 m		30 m		-	
Parking lot, cellar, laboratory, test room, changing room	IP 55	-	-			-	-

... AND THE OUTPUTS  
TO MANAGE

	ON-OFF	DIMMING		
		DALI	1-10 V	Halogen  - Incandescent  - Dimmable LEDs <sup>(1)</sup>
1 lighting circuit in the same room	0 488 50	0 488 51	0 488 52	0 488 45
1 lighting circuit + fan output in the same room	0 488 50	0 488 51	0 488 52	-
2 lighting circuits in the same room	0 488 50	0 488 51	0 488 52	0 488 45
2 lighting circuits + 1 fan output in the same room	-	0 488 51	-	-
2 lighting circuits (2 inputs, 2 outputs) in 2 rooms	0 488 41	-	0 488 42 (1000 VA)	0 488 45
4 lighting circuits (4 inputs, 4 outputs) in 4 rooms	0 488 43	0 488 44 (max. 32 ballasts)	0 488 43	-
2 lighting circuits + 1 blinds output + 1 fan output (4 inputs, 4 outputs) in the same room	0 488 47	-	0 488 47	-

1: Refer to the load table in the data sheet available online in the e-catalogue (**Note:** some dimmable LEDs available on the market are not compatible)  
N.B.: Manual switch option with 0 770 40/33 for 0 488 50/51/52 and with BUS/SCS controls for 0 488 41/42/43/44/45/47

# Motion sensors for 1 circuit

motion sensors for passage areas without natural light



Selection chart p. 590

Automatic on/off  
Manual adjustment of light level threshold and time delay via potentiometer  
All load 8.5 A - 240 V

Pack	Cat.Nos	Ideal for passage areas	Pack	Cat.Nos	Ideal for outdoor and humid areas
1	0 489 11	<p><b>PIR IP 42 wall/surface-mounting motion sensor, 180°</b> Range 8 m Recommended fixing height: 2.5 m 3-wire with neutral Light level threshold: 1 to 1000 lux Adjustable time delay: 5 s to 30 min Standby consumption: 0.7 W For direct surface-mounting on wall Can be mounted on an angle using accessory Cat.No 0 489 71 (p. 596)</p> <p><b>PIR IP 41 wall/flush-mounting motion sensors, 180°</b> Range 8 m Recommended fixing height: 1.2 m Light level threshold: 5 to 1275 lux Adjustable time delay: 5 s to 30 min Standby consumption: 0.4 W ○ White - with neutral ○ White - without neutral</p> <p><b>PIR IP 41 wall/flush-mounting motion sensor for timer, 180°</b> Range 8 m White - without neutral To be associated with a modular time-lag switch (p. 77) Replaces a push-button Recommended fixing height: 1.2 m Standby consumption: 0.2 W Adjustable time-delay: 30 s. to 12 min The time delay must be the same for the sensors and the time lag switch</p> <p><b>PIR IP 41 ceiling-mounting motion sensor, 360°</b> Range Ø8 m Recommended fixing height: 2.50 m 3-wire with neutral Light level threshold: 1 to 1000 lux Adjustable time delay: 5 s to 30 min Consumption: 0.5 W on standby Optimum distance between 2 sensors: 6 m Fixes directly to a false ceiling with mounting claws (included) or installed in a Batibox box, depth 50 mm Can be surface-mounted on ceiling using accessory Cat.No 0 488 75 (p. 596)</p>	1	0 489 31	<p><b>PIR IP 55 wall/surface-mounting motion sensor, 180°</b> Range 8 m Recommended fixing height: 2.5 m 3-wire with neutral Light level threshold: 5 to 1000 lux Adjustable time delay: 5 s to 30 min Standby consumption: 0.7 W For direct surface-mounting on wall Can be mounted on an angle using accessory Cat.No 0 489 71 (p. 596)</p> <p><b>PIR IP 55 wall or ceiling-mounting motion sensors, 360°</b> With directional head, range Ø8 m Fix directly to ceiling or wall (min. height: 1.70 m) 3-wire with neutral Light level threshold: 1 to 1000 lux Adjustable time delay: 12 s to 16 min Standby consumption: 0.9 W Optimum distance between 2 sensors: 6 m ○ Grey ○ White</p>
1	Mosaic 0 784 55	<p>Arteor 5 740 34 5 740 47</p>	1	0 697 40	
1	0 784 54		1	0 697 80	

# Motion sensors for 1 circuit

## detection zones and load table

### Detection zones

Cat.Nos 5 740 47/34, 0 784 54/55 and 0 792 58/59

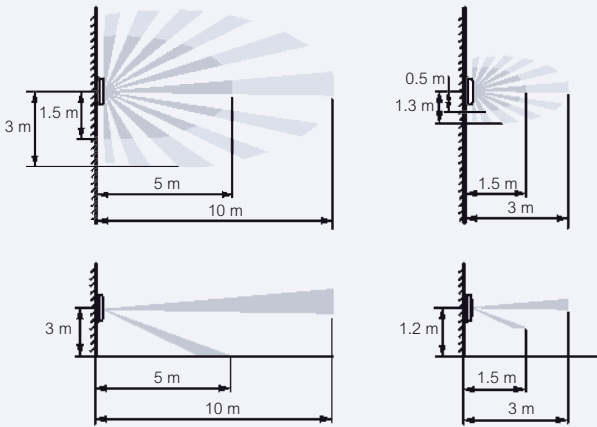

Cat.Nos 0 489 11/31

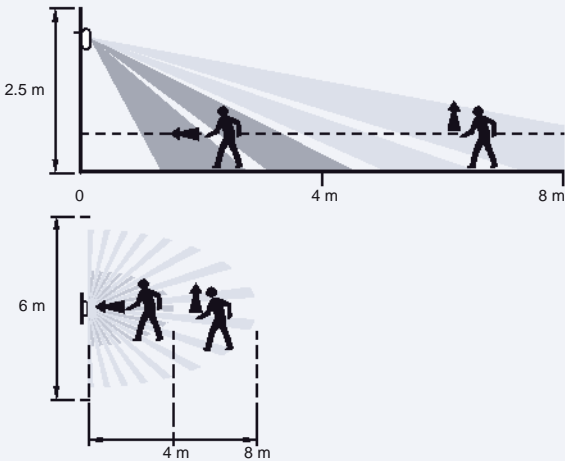

Cat.No 0 488 03

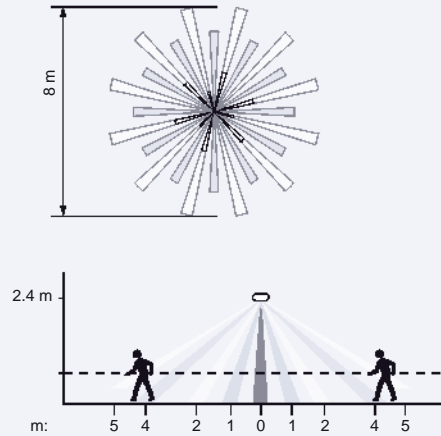

Cat.Nos 0 697 40/80

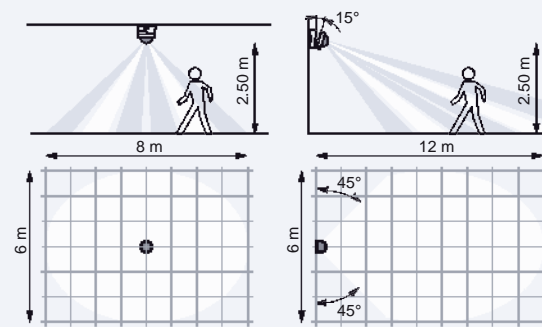

### Load table

Cat.No	Halogen bulb	ELV halogen with ferromagnetic transformer	ELV halogen with electronic transformer	Fluorescent tube	Compact fluorescent bulb	LED
0 784 54 / 5 740 47	2000 W	1000 VA	1000 VA	10 x (2 x 36 W)	250 W	250 W
0 784 55 / 5 740 34	40 x 400 W	40 - 400 VA	40 - 400 VA	-	-	-
0 489 11	2000 W	1000 VA	1000 VA	10 x (2 x 36 W)	250 W	250 W
0 488 03	2000 W	1000 VA	1000 VA	10 x (2 x 36 W)	250 W	250 W
0 489 31	2000 W	1000 VA	1000 VA	10 x (2 x 36 W)	250 W	250 W
0 697 40/80	2000 W	1000 VA	1000 VA	10 x (2 x 36 W)	250 W	250 W

# Lighting Management sensors for 1 circuit

## Lighting Management sensors for passage areas with natural light



Selection chart **p. 590**  
 Technical characteristics **see e-catalogue**

Check presence and natural light level continuously, switch off when there is sufficient natural light  
 Occupancy mode (automatic switch-on/off factory setting)  
 Can be used with push-button Cat.No 0 770 40 (or illuminated push-button Cat.No 0 770 33) for vacancy mode (manual switch-on and manual or automatic switch-off)  
 Precise on-site adjustment using configuration tool Cat.No 0 882 30 (p. 596)  
 Adjustable time delay: 5 s to 59 min. Light level threshold adjustable from 5 to 1275 lux

Pack	Cat.Nos	Ideal for passage areas
1	0 488 17	<b>PIR ceiling-mounting Lighting Management sensors, 360°</b> Fix directly to a false ceiling with mounting claws (included) or installed in a Batibox box, depth 50 mm, Cat.No 0 893 58 3-wire with neutral Standby consumption: 0.4 W Recommended fixing height: 2.5 m Lateral detection 24 m Ideal for hallway, side range 2 x 12 m IP 20 Optimum distance between 2 sensors: 20 m Connection via automatic terminals Surface mounted on ceiling using accessory Cat.No 0 488 75 (p. 596)
1	0 488 07	Range Ø8 m Optimum distance between 2 sensors: 6 m Connection via automatic terminals Surface mounted on ceiling using accessory Cat.No 0 488 75 (p. 596)
1	0 488 08	Range Ø8 m Optimum distance between 2 sensors: 6 m Fast connection
1	0 489 17	<b>PIR IP 42 wall/surface-mounting Lighting Management sensor, 180°</b> Range 15 m Recommended fixing height: 2.5 m 3-wire with neutral Additional 2 A contact for HVAC control based on presence data Standby consumption: 0.4 W Can be mounted on an angle using accessory Cat.No 0 489 71 (p. 596)

Pack	Cat.Nos	Ideal for outdoor and humid areas
1	0 489 33	<b>PIR IP 55 wall or ceiling-mounting Lighting Management sensor, 270°</b> Multi lens sensor with directional head, range 18 m Recommended fixing height: 2.5 m 3-wire with neutral Standby consumption: 0.7 W Can be mounted on an angle using accessory Cat.No 0 489 72 (p. 596)
1	0 489 32	<b>Ideal for high ceiling areas</b> <b>PIR IP 55 ceiling/surface-mounting Lighting Management sensor, 360°</b> Range: Ø20 m at 10 m high, Ø8 m at 2.5 m high 3-wire with neutral IP 66 with cable gland Cat.No 0 980 23 Optimum distance between 2 sensors: 20 m Standby consumption: 0.4 W Compatible with Cablofil cable trays
1	Mosaic 0 784 55   Arteor 5 740 34	<b>Ideal for storage areas and restroom</b> <b>PIR wall, flush-mounting Lighting Management sensors, 180°</b> 180° infrared detection, range 8 m Recommended fixing height: 1.2 m Standby consumption: 0.2 W Optimum distance between 2 sensors: 6 m 2-wire cable (without neutral) For installation in box, depth 40 mm min., or in surface-mounting box Cat.No 0 802 81 2 modules Without neutral ○ White



Examples of solutions for classroom, open-space office and meeting room



# Lighting Management sensors for 1 circuit

## Lighting Management sensors for working areas with natural light



Lighting Management sensor: Integrated push-button

Selection chart **p. 590**  
 Technical characteristics **e-catalogue**

Check presence and light level continuously, switch off when there is sufficient natural light  
 Occupancy mode (automatic switch-on/off factory setting)  
 Can be used with push-button Cat.No 0 770 40 (or illuminated push-button Cat.No 0 770 33) for vacancy mode (manual switch-on and manual or automatic switch-off)  
 Infrared and ultrasonic Lighting Management sensors for workplaces, allowing precise presence detection as soon as the wave transmitted by the sensor is modified (for example, by hand movement on a keyboard)  
 Precise on-site adjustment using configuration tool (p. 596)

Pack	Cat.Nos	Ideal for working areas
		Suitable for meeting room, classroom, open space, etc.
		<b>Dual technology ceiling-mounting Lighting Management sensors, 360°</b>
		Infrared and ultrasonic detection, Ø8 m IP 20 3-wire with neutral Optimum distance between 2 sensors: 6 m Standby consumption: 0.8 W Fix directly to a false ceiling with mounting claws (included) or installed in a Batibox box, depth 50 mm Connection via automatic terminals Can be surface-mounted in ceiling using accessory Cat.No 0 488 75 (p. 596)
1	0 488 06	Fast connection
1	0 488 09	
		<b>PIR technology wall/surface-mounting Lighting Management sensor, 180°</b>
1	0 489 14	With presence output Infrared and ultrasonic detection, range (front) 8 m Recommended fixing height: 2.5 m 3-wire with neutral IP 42 Additional 2 A contact for HVAC control based on presence data Consumption: 0.4 W on standby Optimum distance between 2 sensors: 10 m Can be surface-mounted on ceiling using accessory Cat.No 0 489 71 (p. 596)
		<b>Dual technology wall/surface-mounting Lighting Management sensor, 180°</b>
1	0 489 16	With presence output Infrared and ultrasonic detection, range (front) 8 m Recommended fixing height: 2.5 m 3-wire with neutral IP 42 Additional 2 A contact for HVAC control based on presence data Consumption: 0.4 W on standby Optimum distance between 2 sensors: 10 m Can be surface-mounted in ceiling using accessory Cat.No 0 489 71 (p. 596)

Pack	Cat.Nos	Ideal for offices
		<b>Dual technology wall, flush-mounting Lighting Management sensors, 180°</b>
		Infrared and ultrasonic detection, range 8 m Recommended fixing height: 1.20 m Standby consumption: 0.2 W Optimum distance between 2 sensors: 6 m 3-wire cable IP 41 For installation in box, depth 40 mm min., or in surface-mounting box Cat.No 0 802 81 2 modules
1	Mosaic 0 784 52	With neutral Without neutral
1	Arteor 0 784 53 / 5 740 49 / 5 740 31	
		<b>PIR ceiling-mounting Lighting Management sensors, 360°</b>
		Range Ø8 m 3-wire with neutral Optimum distance between 2 sensors: 6 m Standby consumption: 0.8 W Fix directly to a false ceiling with mounting claws (included) or installed in a Batibox box, depth 50 mm Can be surface-mounted in ceiling using accessory Cat.No 0 488 75 (p. 596)
1	0 488 00	Without 2 A contact for HVAC control
1	0 488 04	With an additional 2 A contact for HVAC control, based on presence data

Examples of solutions for classroom, open-space office and meeting room





Technical characteristics **see e-catalogue**

Pack	Cat.Nos	Configuration tools for Lighting Management sensors
1	0 882 35	<p>All sensors are supplied with factory settings:</p> <ul style="list-style-type: none"> <li>- 500 lux light level threshold for ceiling mount sensors, 300 lux for surface and flush mounting sensors</li> <li>- 15-minute time delay and walkthrough function activated</li> </ul> <p>The configuration tools are used to adjust these presets and the detection sensitivity. Step programming on preset buttons</p> <p>Digital programming to one decimal place on the digital screen</p> <p>Instant programming control</p> <p>Used to display the parameters of each sensor</p> <p>Option to store settings in the memory and to apply them to other sensors</p> <p>Standard preset configurations for each room type (office, hallway, etc.) according to EN 12 464</p>
1	0 882 30	
10	0 488 72	<p><b>RJ 45-BUS/SCS connector</b></p> <p>Used to connect controller(s) and sensor(s) to a BUS/SCS cable via tap-off</p> <p>Male connector</p>
10	0 488 68	<p><b>RJ 45 doubler</b></p> <p>Used to double the number of controller inputs</p>
1	0 488 75	<p><b>Surface-mounting boxes</b></p> <p>For ceiling-mounting sensors</p> <p>Cat.Nos 0 488 00/03/04/06/07/08/09/17/20/22/35</p>
1	0 489 71	<p><b>Fixing accessories for angled installations</b></p> <p>For surface-mounting sensors Cat.Nos 0 489 11/14/16/17/31</p> <p>For surface-mounting sensor Cat.No 0 489 33</p>
1	0 489 72	
1	0 489 75	<p><b>Accessories</b></p> <p>Rotate accessory for surface-mounting boxes, for sensors Cat.Nos 0 489 11/14/16/17/31</p> <p>Protection basket for sensors</p> <p>Cat.Nos 0 489 11/14/16/17/31/32/33</p>
1	0 489 74	

Examples of solutions for classroom, open-space office and meeting room



### ■ Customising settings on-site

All sensors are preset in the factory

- 500 lux light level threshold for ceiling-mounting sensors and 300 lux for surface-mounting sensors
- 15-minute time delay and walkthrough function activated

The configuration tools are used to adjust the preset settings and the detection sensitivity

### ■ Installing surface-mounting boxes Cat.No 0 488 75

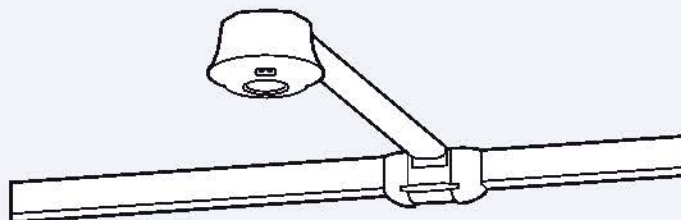

### ■ Installing fixing accessories on an angle (view from above)

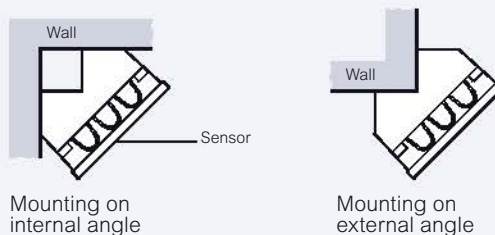

Mounting on internal angle

Mounting on external angle

# Lighting Management sensors for managing several circuits

multi-circuit ceiling-mounting controllers for areas with natural light

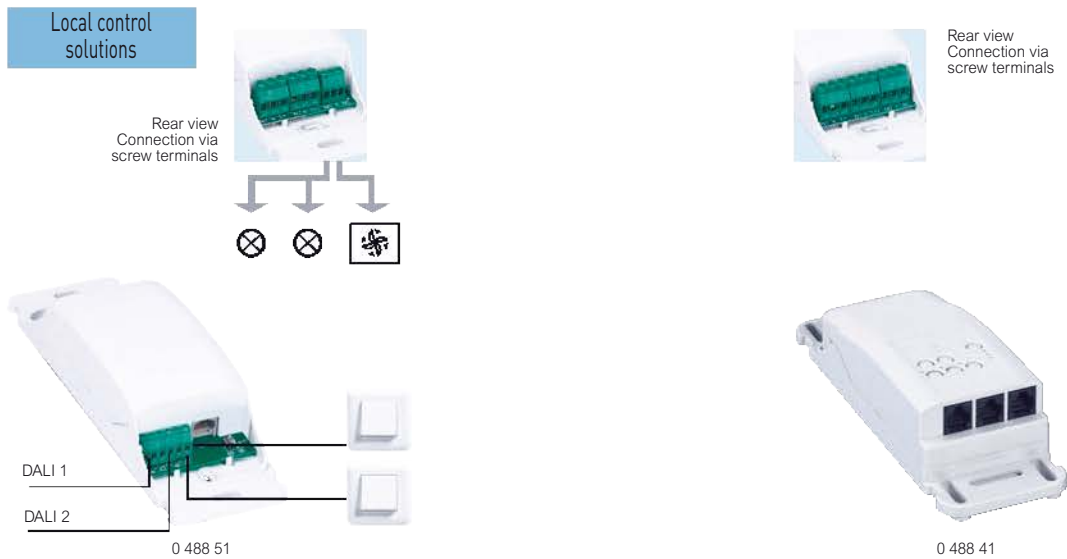

Sensor and controller selection chart **p. 591**  
 Technical characteristics **see e-catalogue**

Ceiling-mounting or installation in Cablofil cable trays (see Legrand Cable Management catalogue)  
 Connection to sensors (Cat.Nos 0 488 20/22/30/24/23/25 and 0 784 85/86, 5 740 46/48) by cord or RJ 45 cable (p. 677) or BUS/SCS cable to be fitted with RJ 45 connector Cat.No 0 488 72 (p. 596)

Pack	Cat.Nos	For controlling 1 or 2 circuits in one room
1	0 488 50	1 sensor input, 2 inputs for auxiliaries 2 outputs Can be used with a push-button, including a push-button with LED indicator, Cat.Nos 0 770 40/33 for manual switch-on and manual or automatic switch-off <b>ON/OFF</b> 2 x 16 A outputs Used to control 2 ON/OFF lighting circuits or 1 lighting circuit + 1 ventilation circuit Connection via screw terminals
1	0 488 51	<b>Dimming - DALI ballast</b> 2 DALI outputs (32 ballasts max.) and 1 ventilation output (volt-free contact) Used to vary the light level on the window side of a room (where there is more natural light) separately from the hallway side Used to control a maximum of 32 DALI ballasts Connection via screw terminals
1	0 488 52	<b>Dimming - 1-10 V ballast</b> 2 x 1000 VA lighting outputs Used to vary the light level on the window side of a room (where there is more natural light) separately from the hallway side Connection via screw terminals
<b>For controlling 2 lighting circuits</b>		
1	0 488 41	Can be controlled for each output by a sensor and/or an individual BUS control unit Addressing methods using sensors and control units: - automatic configuration - custom configuration by pressing the "Learn" button on the product <b>ON/OFF</b> 2 x 16 A outputs
1	0 488 42	<b>Dimming - 1-10 V ballast</b> 2 outputs 1000 VA maximum per output
1	0 488 45	<b>Dimming - LV and ELV halogen</b> 2 outputs 1000 W maximum per output

Pack	Cat.Nos	For controlling 4 lighting circuits
1	0 488 43	Can be controlled for each output by a sensor and/or an individual BUS control unit Addressing methods using sensors and control units: - automatic configuration - custom configuration by pressing the "Learn" button on the product <b>Dimming - ballast 1-10 V or ON/OFF</b> 4 outputs 1000 VA maximum per output
1	0 488 44	<b>Dimming - DALI ballast</b> 4 outputs 32 ballasts maximum per output
<b>For controlling 2 lighting circuits, 1 shutter and 1 HVAC contact</b>		
1	0 488 47	Can be controlled for each output by a sensor and/or an individual BUS control unit Addressing methods using sensors and control units: - automatic configuration - custom configuration by pressing the "Learn" button on the product 2 ON/OFF or 1-10 V dimming lighting outputs 1 output for roller shutters 1 ventilation output (volt-free contact)

Examples of solutions for classroom, open-space office and meeting room



# Lighting Management sensors for managing several circuits

Lighting Management sensors for controllers for passage areas and working areas with natural light



Local control solutions



Connection to controller via cord or RJ 45 cable



0 488 25  
(IR detection)

Integrated push-button



0 784 86 / 5 740 48



0 488 22  
(IR + US detection)



0 488 23  
(IR + US detection)

Sensor and controller selection chart **p. 591**  
Technical characteristics **see e-catalogue**

Check presence and light level continuously, switch off when there is sufficient natural light

Automatic switch-on/off (factory setting)

Precise on-site adjustment using configuration tool (p. 596)

Connect to controllers by cord or RJ 45 cable or BUS/SCS cable to be fitted with RJ 45 connector Cat.No 0 488 72 (p. 596)

Pack	Cat.Nos	Ideal for large areas
1	0 488 20	<b>PIR technology ceiling-mounting Lighting Management sensor, 360°</b> Range Ø8 m IP 20 Optimum distance between 2 sensors: 6 m Consumption: 0.2 W on standby Fixes directly to a false ceiling with mounting claws (included) or installed in a Batibox box, depth 50 mm Can be surface-mounted on ceiling using accessory Cat.No 0 488 75
1	0 488 25	<b>PIR technology wall/surface-mounting Lighting Management sensor, 140°</b> With directional head, range 30 m IP 42 Consumption: 0.2 W on standby Supplied with fixing plate
1	Mosaic 0 784 85   Arteor 5 740 46	<b>PIR technology wall, flush-mounting Lighting Management sensors, 180°</b> Range 8 m Recommended fixing height: 1.2 m IP 41 Consumption: 0.2 W on standby Integrated push-button For installation in box, depth 40 mm min., or in surface-mounting box Cat.No 0 802 81 2 modules 
1	0 488 24	<b>PIR technology wall/surface-mounting Lighting Management sensor, 180°</b> With directional head, range (front) 5 m IP 42 Consumption: 0.2 W on standby Supplied with fixing plate
1	0 488 30	<b>Ideal for outdoor and humid areas</b> <b>PIR technology wall/surface-mounting Lighting Management sensor, 270°</b> Detection: side range 2 x 15 m and front range 10 m IP 55 Consumption: 0.5 W on standby Supplied with fixing plate

Pack	Cat.Nos	Ideal for working areas
1	Mosaic 0 784 86   Arteor 5 740 48	<b>Dual technology wall, flush-mounting Lighting Management sensors, 180°</b> Infrared and ultrasonic detection, range 8 m Recommended fixing height: 1.2 m IP 41 Consumption: 0.2 W on standby Integrated push-button
1	0 488 22	<b>Dual technology ceiling-mounting Lighting Management sensor, 360°</b> Infrared and ultrasonic detection, range Ø8 m Recommended fixing height: 2.50 m IP 20 Optimum distance between 2 sensors: 6 m Consumption: 0.5 W on standby Fixes directly to a false ceiling with mounting claws (included) or installed in a Batibox box, depth 50 mm Can be surface-mounted on ceiling using accessory Cat. No 0 488 75 (p. 596)
1	0 488 23	<b>Dual technology wall/surface-mounting Lighting Management sensor, 180°</b> Infrared and ultrasonic detection with directional head, range (front) 7 m Consumption: 0.5 W on standby Supplied with fixing plate
1	0 488 28	<b>Light level measurement cell</b> For synchronising the light level measurement when used with sensors Use the configuration tool Cat.No 0 882 30 (p. 596) to configure the light level cell Connects to the BUS/SCS cable with connector Cat.No 0 488 72 IP 20
10 10	0 488 72 0 488 73	<b>RJ 45-BUS/SCS connectors</b> Used to connect controller(s) and sensor(s) to a BUS/SCS cable via tap-off Male connector Female connector





# Lighting Management

## BUS/SCS controls



Sensor and controller selection chart **p. 591**  
 Technical characteristics **e-catalogue**

**Connection:**

- to the BUS/SCS controller via cord or RJ 45 cable or BUS/SCS cable to be fitted with RJ 45-BUS/SCS connector Cat.No 0 488 72 (p. 596)
- directly to the BUS/SCS cable (supplied with BUS/SCS connector Cat.No 3515 for connection to the BUS/SCS cable via tap-off)
- To be fitted with Mosaic cover plates and Batibox support frames

Pack	Cat.Nos	ON/OFF lighting controls
1	Mosaic 0 784 75	<b>Push-button control used to control 1 controller</b> <b>1-way</b> Used to control 1 lighting circuit (1 output) <input type="radio"/> White <input type="radio"/> Aluminium
1	0 791 75	
1	0 784 72	<b>2-way</b> Used to control 2 lighting circuits (2 outputs) <input type="radio"/> White <input type="radio"/> Aluminium
1	0 791 72	
1	Arteor 0 675 53	<b>ON/OFF control unit</b> To be equipped with cover plates (p. 410), support frames and plates (p. 386-393 and 408) 
<b>Switch multifunction controls</b>		
1	Mosaic 0 784 71	Used to control several controllers (or several outputs on one or more controllers): ON/OFF, dimming, ventilation, roller shutters <b>1-way</b> <input type="radio"/> White <input type="radio"/> Aluminium
1	0 791 71	
1	0 784 73	<b>2-way</b> <input type="radio"/> White <input type="radio"/> Aluminium
1	0 791 73	
1	Arteor 0 675 52	"Switch type" multifunctional control unit To be equipped with cover plates (p. 410), support frames and plates (p. 386-393 and 408) 
<b>Scenario controls</b>		
Used to control several controllers		
<b>2 scenarios</b> 4 buttons used to manage the start and end of each scenario Example: adjusting lighting levels, controlling lighting with shutters, etc.		
1	Mosaic 0 784 78	<input type="radio"/> White <input type="radio"/> Aluminium
1	0 791 78	
1	Arteor 5 739 02	<input type="radio"/> White <input type="radio"/> Magnesium
1	5 739 03	

# Lighting Management

## KNX control units



Directly connected to the KNX Bus (supplied with KNX connector)  
 Programming through ETS software  
 For lighting control (ON/OFF, dim, scenario, etc.), shutters and slats controls, automation control  
 Equipped with 4 programmable Red Green Blue LEDs (12 colours available) to indicate the status of the loads and provide system and alarm status feedback

Pack	Cat.Nos	KNX control units - Mosaic™ Programme
1	0 784 89	To be equipped with support frames and plates <b>1 pushbutton</b> 1 actuation point 
1	0 784 95	<b>2 pushbuttons</b> 2 actuation points 
1	0 784 94	<b>2 pushbuttons</b> 2 actuation points 
1	0 784 96	<b>4 pushbuttons</b> 4 actuation points 
1	0 784 91	<b>4 pushbuttons</b> 4 actuation points With label-holder 
<b>KNX control units - Arteor</b>		
1	0 675 71	To be equipped with cover plates (p. 410), support frames and plates (p. 386-393 and 408) <b>1 or 2 pushbuttons</b> 4 actuation points 
1	5 742 03	<b>4 pushbuttons - square version</b> 4 actuation points With label-holder <input type="radio"/> White <input type="radio"/> Magnesium
1	5 744 04	
1	5 735 02	<b>4 pushbuttons - round version</b> 4 actuation points With label-holder <input type="radio"/> White <input type="radio"/> Magnesium
1	5 735 03	



# KNX smart control

from **Legrand**



#### ■ KNX manual controls

Multifunction controls with LED colour feedback to meet highest requests of technology and design



#### ■ KNX sensors

For automatic lighting control of open spaces, individual offices, corridors and outdoor areas  
To maximise energy savings



Hotel controller



False-ceiling controller



DALI controller

#### ■ KNX controllers

To control any kind of luminaires:  
DALI - 1-10 V - LEDs  
To provide maximum comfort and flexibility



For detailed information, please refer to the Legrand KNX brochure:  
[www.docexport.legrand.com](http://www.docexport.legrand.com)

# Fully compatible smart infrastructure

Legrand's active building management solutions are based on a smart communication infrastructure compatible with various protocols such as KNX, Modbus, DALI and Bacnet

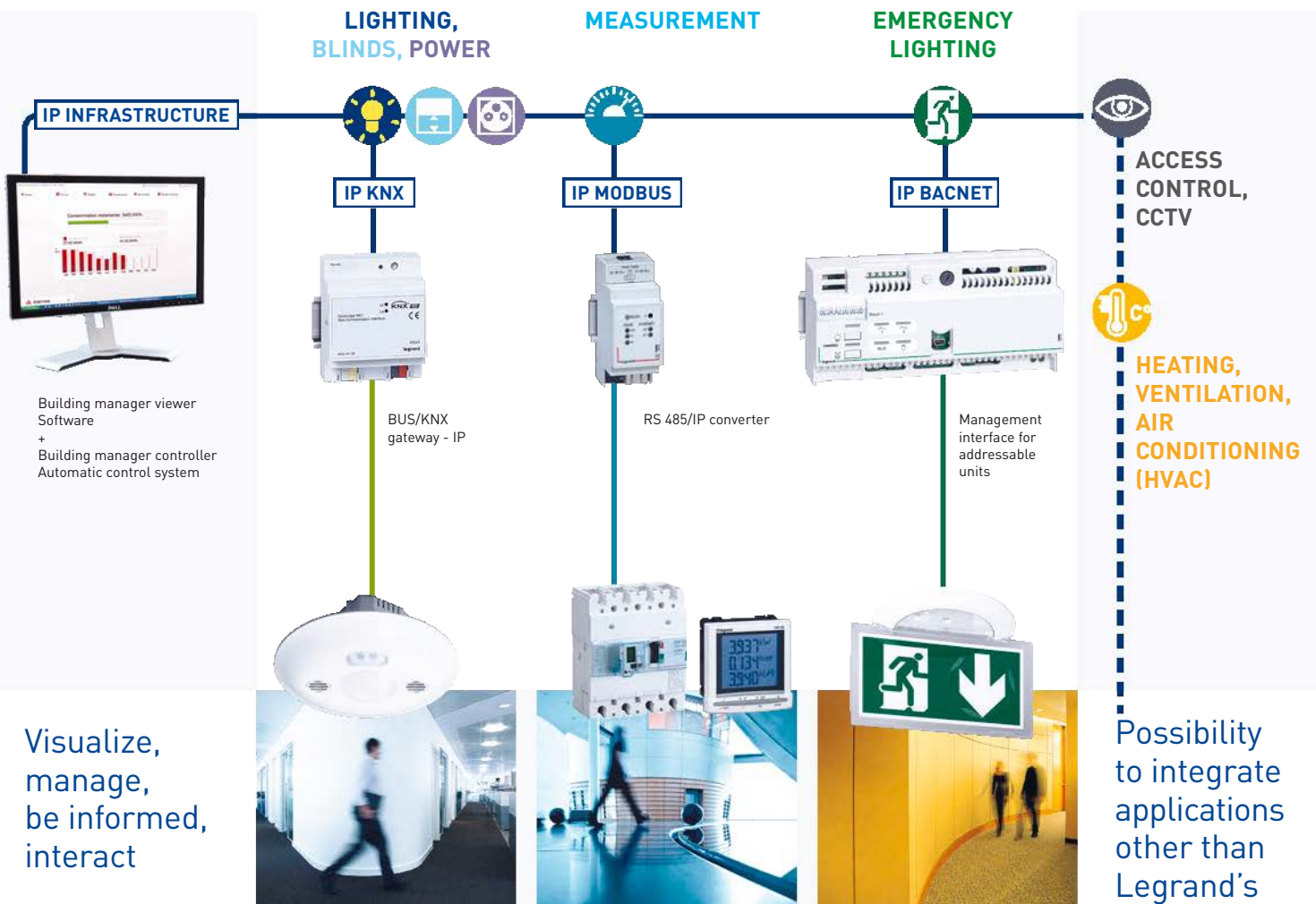

# Weatherproof bulkhead lights IP 44/IP 54



0 604 50



0 604 14



0 604 05



0 624 20



0 620 20

Dimensions **see e-catalogue**

Pack	Cat.Nos	Round - IP 44 - IK 07 - Class II
		Polypropylene base For 15 W compact fluorescent lamps Diffuser is assembled by a 1/4 turn rotation Porcelain lampholder White RAL 9010
5	B 22   E 27 0 604 50   0 604 51	Glass diffuser
10	0 604 58   0 604 59	Polycarbonate diffuser

Pack	Cat.Nos	Oval - IP 44 - IK 06 - Class II
		Polypropylene base Glass diffuser Galvanised steel or plastic Protection wire grid 3 side knockable entries, for Ø16, 20 mm cable - 230 V - 50 Hz Self-extinguishing: 850 °C For compact fluorescent lamps Porcelain lampholder Screw terminals
12	Grey   White 0 604 14   0 604 15	<b>12 W - E 27</b> Metal grid - no tool required
12	0 604 05   0 604 92	Metal grid - screw fixing
12		Plastic grid - screw fixing
10	Grey 0 604 19	<b>20 W - E 27</b> Metal grid - screw fixing

Pack	Cat.Nos	Round - IP 54 - IK 04 - Class II
		Polycarbonate base and trim Diffuser: opal glass Self-extinguishing: 850 C° 30 sec. Compact fluorescent lamp can be used in bulkhead lights with E 27 lampholder High resistance weatherproof seal Captive screws Automatic terminals
1	 White 0 624 20	<b>With integrated sensor - for domestic, commercial areas</b> Ø 310 mm Integrated 4000K 830 lm LED bulkhead light with detection + switch-off warning + adjustable automatic standby On/off by switch or sensor: - ON: progressive to 100% flow in 3 sec. - OFF: initiation of Switch-off warning and Standby functions Switch-off warning: progressive reduction in the light flow to 10% in 12 sec. Adjustable automatic standby: light flow at 10% timed for 30 min. Can monitor bulkhead lights Cat.Nos 0 624 10/11/12 (loads must not be mixed) Possibility to: - implement several bulkhead lights Cat.No 0 624 20 per line - adjust settings (time delay, daylight setpoint and detection range...) with configuration tool Cat.No 0 882 30 (p. 596)
1	0 624 21	53 W 850 lm halogen bulkhead light with detection Halogen lamp supplied Possibility to manually adjust settings: time delay, daylight setpoint and detection range...
1	0 624 10	<b>Standard - for domestic, commercial areas</b> Ø 310 mm 4000K 830 lm LED bulkhead light
1	0 624 12	For E27 - 53 W - 850 lm halogen lamp (supplied)
1	0 624 11	For G24Q2 - 18 W - 1200 lm fluorescent lamp (supplied) With electronic ballast
1	0 620 20	<b>Decorative - for exterior use</b> E27 - 100 W - PL 15 W bulkhead light Plain - size 2 - Ø 340 mm Electrical connection: 1 entry via the rear with membrane gland Supplied without lamp in cardboard box

# Weatherproof and vandal-resistant bulkhead lights IP 54/IP 55

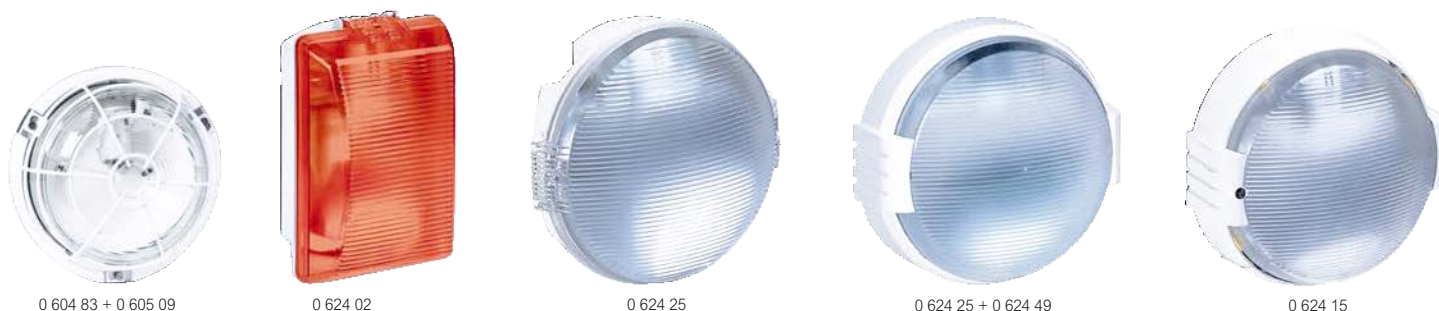

Dimensions **see e-catalogue**

For domestic, commercial areas and tough environments





Pack	Cat.Nos	<b>Weatherproof bulkhead lights for tough environments</b>
1	E 27 0 604 77	Metal/glass bulkhead lights. For exterior/indoor use For industrial use. Earth terminal - 3 entries in T Operating temperature: - min.: - 30 °C, - max.: + 35 °C IP 55 - IK 04 Oval - for 55 W halogen, 17 W compact fluorescent or 8 W LED lamps With colourless glass diffuser
1	0 605 08	Metal protection grid for Cat.No 0 604 77 For IK 07 protection
1	0 604 83	Round - for 70 W halogen, 20 W compact fluorescent or 12 W LED lamps With colourless diffuser
1	0 605 09	Metal protection grid for Cat.No 0 604 83 For IK 07 protection

Pack	Cat.Nos	<b>Plexo rectangular - IP 54 - IK 08 - class II</b>
5	E 27 0 624 00	Polycarbonate diffuser, mounted on hinge Opening can be reversed Top/Base Supplied with one Plexo end cap, not assembled Through wiring or terminal connection (side or rear) Lampholder mounted on reflector (swivel pull-out type) Grey base self-extinguishing: 850 °C For E27 - 55 W halogen, 17 W compact fluorescent or 8 W LED lamps With clear diffuser
5	0 624 02	With red diffuser

Pack	Cat.Nos	<b>Round Koro bulkhead lights and accessory</b>
5	E 27 0 624 25	<b>IP 54 - IK 08 - class II</b> Polycarbonate diffuser, mounted on hinge Opening can be reversed right/left Supplied with 1 Plexo end cap, not assembled Through wiring or terminal connection (side or back) Porcelain lampholder mounted on reflector (swivel pull-out type) Self-extinguishing at 850 °C White For E27 - 70 W halogen, 20 W compact fluorescent or 12 W LED lamps
1	0 624 49	<b>Finishing accessories</b> White clip-on cover plate for round bulkhead lights Polycarbonate







Pack	Cat.Nos	<b>Vandal-resistant Koro bulkhead lights</b>
1	E 27 0 624 15	For risk situation, indoors and outdoors tough environments, internal and external applications <b>IP 55 - IK 09 - class II</b> Security assured by covering trim Locked with 2 special screws which may be locked with key Cat.No 0 919 45 (below) Shock-resistant polycarbonate diffuser Opening can be reversed right / left supplied with 1 Plexo membrane gland Through-wiring or terminal connection (side or rear) White Round for E27 - 70 W halogen or 20 W compact fluorescent lamps
1	0 919 45	<b>Vandal resistant accessory</b> Screwdriver to remove/tighten tamperproof screws

## Select your emergency lighting luminaires

INDOOR SELF-CONTAINED EMERGENCY LIGHTING LUMINAIRES												
	OPERATING MODE			IP	IK	DURATION	LUMEN OUTPUT RANGE	BATTERY TYPE	LIGHTING SOURCE	Cat.Nos		
	NM <sup>1</sup>	M <sup>1</sup>	C/S <sup>1</sup>							Standard	Autotest / Adressable LVS2	
<b>U34<sup>LED</sup> (p. 606)</b>												
	Yes	Yes	-	42	07	1 h	250 Lm	Ni-MH	LED	6 611 60	6 621 60	
	Yes	Yes	-				450 Lm	Ni-MH	LED	6 611 80	6 621 80	
	Yes	Yes	-			3 h	200 Lm	Ni-MH	LED	6 611 90	6 621 90	
<b>URA ONE (p. 608)</b>												
	Yes	-	-	42	07	1 h	70 Lm	Ni-Cd	LED	6 616 20	-	
	Yes	-	-				100 Lm	Ni-Cd	LED	6 616 21	-	
	Yes	Yes	-					Ni-Cd	LED	6 616 31	6 626 31	
	Yes	-	-				160 Lm	Ni-Cd	LED	6 616 22	-	
	Yes	Yes	-					Ni-Cd	LED	6 616 32	-	
	Yes	Yes	-				200 Lm	Ni-Cd	LED	6 616 33	6 626 33	
	Yes	Yes	-				350 Lm	Ni-Cd ; Ni-MH	LED	6 616 34	6 626 34	
	Yes	Yes	-			3 h	100 Lm	Ni-MH	LED	6 616 40	6 626 40	
<b>U21<sup>LED</sup> (p. 609)</b>												
	Yes	-	-	42	04	1 h	70 Lm	Ni-Cd	LED	6 616 01	-	
	Yes	-	-				100 Lm	Ni-Cd	LED	6 616 02	-	
	Yes	Yes	-					Ni-Cd	LED	6 616 03	6 626 03	
	Yes	-	-				160 Lm	Ni-Cd	LED	6 616 05	-	
	Yes	Yes	-				200 Lm	Ni-Cd	LED	6 616 06	6 626 06	
	Yes	Yes	-				350 Lm	Ni-Cd ; Ni-MH	LED	6 616 07	6 626 07	
	Yes	Yes	-			3 h	100 Lm	Ni-MH	LED	6 616 10	6 626 10	
<b>U21<sup>NEW</sup> (p. 609)</b>												
	Yes	-	-	42	04	1 h	50 Lm	Ni-Cd	Fluo 1 x TL 6W	6 617 10	-	
	Yes	-	-				70 Lm	Ni-Cd	Fluo 1 x TL 6W	6 617 01	-	
	Yes	-	-				100 Lm	Ni-Cd	Fluo 1 x TL 6W	-	6 627 02	
	Yes	-	-				110 Lm	Ni-Cd	Fluo 1 x TL 6W	6 617 02	-	
	Yes	-	-				160 Lm	Ni-Cd	Fluo 1 x TL 6W	6 617 05	6 627 05	
	-	-	Yes					Ni-Cd	Fluo 2 x TL 6W	6 617 09	6 627 09	
	Yes	-	-				200 Lm	Ni-Cd	Fluo 1 x TL 6W	-	6 627 06	
	Yes	-	-				240 Lm	Ni-Cd	Fluo 1 x TL 6W	6 617 06	-	
	Yes	-	-				300 Lm	Ni-Cd	Fluo 1 x TL 6W	6 617 07	-	
	Yes	-	-				310 Lm	Ni-Cd	Fluo 1 x TL 6W	-	6 627 07	
	Yes	-	-				3 h	90 Lm	Ni-Cd	Fluo 1 x TL 6W	6 617 11	-
	Yes	-	-					100 Lm	Ni-Cd	Fluo 1 x TL 6W	-	6 627 14
	-	-	Yes			100 Lm		Ni-Cd	Fluo 2 x TL 6W	-	6 627 15	

1: NM: Non Maintained ; N: Maintained ; C/S: combined or sustained

## Select your emergency lighting luminaires (continued)

WEATHERPROOF SELF-CONTAINED EMERGENCY LIGHTING LUMINAIRES												
	OPERATING MODE			IP	IK	DURATION	LUMEN OUTPUT RANGE	BATTERY TYPE	LIGHTING SOURCE	Cat.Nos		
	NM <sup>1</sup>	M <sup>1</sup>	C/S <sup>1</sup>							Standard	Autotest / Adressable LVS2	
<b>B66<sup>LED</sup> IP 66 (p. 611)</b>												
	Yes	Yes	-	66	10	1 h	100 Lm	Ni-MH	LED	6 615 41	-	
	Yes	Yes	-				250 Lm	Ni-MH	LED	6 615 43	6 625 43	
	Yes	Yes	-				450 Lm	Ni-MH	LED	6 615 45	6 625 45	
<b>INOX<sup>LED</sup> IP 67 (p. 611)</b>												
	Yes	Yes	-	67	07	1 h	400 Lm	Ni-MH	LED	-	6 625 60	
	Yes	Yes	-			3 h	200 Lm	Ni-MH	LED	-	6 625 61	
<b>B65<sup>NEW</sup> IP 65 (p. 612)</b>												
	Yes	-	-	65	07	1 h	100 Lm	Ni-Cd	Fluo 1 x TL 6W	6 614 01	6 624 01	
	-	-	Yes					Ni-Cd	Fluo 2 x TL 6W	6 614 23	6 624 23	
	Yes	-	-				250 Lm	Ni-Cd	Fluo 1 x TL 6W	6 614 02	6 624 02	
	-	-	Yes					Ni-Cd	Fluo 2 x TL 6W	6 614 24	6 624 24	
	Yes	-	-				300 Lm	Ni-Cd ; Ni-MH	Fluo 1 x TL 6W	6 614 03	6 624 03	
	Yes	-	-				450 Lm	Ni-Cd ; Ni-MH	Fluo 1 x PL 11W	6 614 04	6 624 04	
<b>B65<sup>LED</sup> IP 65 (p. 612)</b>												
	Yes	Yes	-	65	07	1 h	100 Lm	Ni-Cd	LED	6 614 31	6 624 31	
	Yes	Yes	-				200 Lm	Ni-Cd	LED	6 614 33	6 624 33	
	Yes	Yes	-				350 Lm	Ni-Cd ; Ni-MH	LED	6 614 34	6 624 34	
	Yes	Yes	-			3 h	100 Lm	Ni-Cd ; Ni-MH	LED	6 614 40	6 624 40	
<b>BS COMPLIANCE OFFER (8 W STANDARD)</b>												
	OPERATING MODE			IP	IK	DURATION	LUMEN OUTPUT RANGE	BATTERY TYPE	LIGHTING SOURCE	Cat.Nos		
	NM <sup>1</sup>	M <sup>1</sup>	C/S <sup>1</sup>							Standard	Autotest / Adressable LVS2	
<b>B66 IP 66 (p. 615)</b>												
	Yes	-	-	66	08	1 h	100 Lm	Ni-Cd	Fluo 1 x TL 8W	6 615 21	6 625 21	
	-	Yes	-					Ni-Cd	Fluo 1 x TL 8W	6 615 01	-	
	-	-	Yes					Ni-Cd	Fluo 2 x TL 8W	6 615 02	-	
	Yes	-	-				250 Lm	Ni-Cd	Fluo 1 x TL 8W	6 615 23	6 625 23	
	-	Yes	-					Ni-Cd	Fluo 1 x TL 8W	6 615 11	6 625 01	
	-	-	Yes					Ni-Cd	Fluo 2 x TL 8W	6 615 12	6 625 02	
	-	Yes	-			400 Lm	Ni-Cd	Fluo 1 x TL 8W	-	6 625 06		
	-	-	Yes				Ni-Cd	Fluo 2 x TL 8W	-	6 625 07		
	Yes	-	-				450 Lm	Ni-Cd	Fluo 1 x PL 11W	6 615 25	6 625 25	
	Yes	-	-			3 h	150 Lm	Ni-Cd	Fluo 1 x TL 8W	6 615 35	-	
	-	Yes	-					Ni-Cd	Fluo 1 x TL 8W	6 615 36	-	
	-	-	Yes					Ni-Cd	Fluo 2 x TL 8W	6 615 37	-	
<b>S8 (p. 614)</b>												
	Yes	Yes	-	42	04		1 h	140 Lm	Ni-Cd	Fluo 1 x TL 8W	0 660 00	-
	-	Yes	-						Ni-Cd	Fluo 1 x TL 8W	0 660 01	-
	-	-	Yes			Ni-Cd			Fluo 2 x TL 8W	0 660 02	-	
	Yes	Yes	-			3 h	110 Lm	Ni-Cd	Fluo 1 x TL 8W	0 660 03	-	
	-	Yes	-					Ni-Cd	Fluo 1 x TL 8W	0 660 04	-	
	-	-	Yes					Ni-Cd	Fluo 2 x TL 8W	0 660 05	-	

1: NM: Non Maintained ; N: Maintained ; C/S: combined or sustained

# U34<sup>LED</sup> environment friendly

indoor self-contained emergency lighting luminaires LED



6 621 60



6 621 60 + 6 612 96



6 621 60 + 6 612 92 + 6 612 94 + 6 618 00

Spare batteries selection chart **p. 617**  
Adhesive labels **p. 616**

LED maintained/ non maintained units  
High power LEDs with specially designed lens optimizing the lighting distribution  
IP 42 - IK 07  
Class II   
Power supply: 230 V ± 10% - 50/60 Hz  
Very low consumption switching power supply  
Fully recyclable after removing  
Environment friendly Ni-MH batteries  
Removable plug-in plate to ease installation and maintenance  
Automatic terminals with high capacity: 2 x 2.5 mm<sup>2</sup>  
Charge monitor with a green LED  
Can be equipped with metallic protection grids Cat.Nos 0 626 92/93 (p. 616)

Pack	Cat.Nos	Standard luminaires
		Standard luminaires incorporate an external manual lamp test with testing tool Cat.No 6 612 99
1	6 611 60	<b>1 h duration with transparent diffuser</b> Maintained/Non maintained - 250 lm - 1h (LEDs)
1	6 611 80	Maintained/Non maintained - 450 lm - 1h (LEDs)
		<b>3 h duration with transparent diffuser</b>
1	6 611 90	Maintained/Non maintained - 200 lm - 3h (LEDs)
Autotest/addressable luminaires		
		Autotest/addressable luminaires incorporate an automatic self-testing system Tests result is visible on 2 signalling LEDs (green-OK and yellow-defective) Addressable function is activated by setting an ID on each luminaire with infrared configuration tool (Cat. No. 0 626 10) and wiring a complementary BUS line Operating state of all addressable luminaires can be centralized by the control interface (Cat. No. 0 626 00) and monitored on a local touch screen controller (Cat.No 0 626 01), or with the building's plan on Legrand Vision System (LVS2) PC software Cat.No 0 626 02
1	6 621 60	<b>1 h duration with transparent diffuser</b> Maintained/Non maintained - 250 lm - 1h (LEDs)
1	6 621 80	Maintained/Non maintained - 450 lm - 1h (LEDs)
1	6 621 90	<b>3 h duration with transparent diffuser</b> Maintained/Non maintained - 200 lm - 3h (LEDs)

Pack	Cat.Nos	Accessories
1	6 612 81	Lateral cabling accessory for U33/U34 <sup>LED</sup> plug-in plate
1	6 612 96	Slim flush-mounting frame for dry partitions Must be installed without vertical signalling plate
1	6 612 92	Flush-mounting frame for dry partitions Can be installed with vertical signalling plate Cat.No 6 612 94
1	6 612 93	Flush-mounting box for masonry (to be added with flush-mounting frame)
1	6 612 94	Vertical signalling plate Must be completed with plastic signalling labels (non adhesive) Cat.Nos 6 618 00/01/02/03/40/50/51
1	6 612 99	Testing tool for U34 LED, U33, B66 LED and B66 standard luminaires
Labels for U34 <sup>LED</sup>		
		Plastic signalling labels (non adhesive) to be exclusively integrated into the vertical signalling plate Cat.No 6 612 94
1	6 618 00	127 x 254 mm
1	6 618 01	127 x 254 mm
1	6 618 02	127 x 254 mm
1	6 618 03	127 x 254 mm
1	6 618 40	127 x 254 mm
1	6 618 50	127 x 254 mm
1	6 618 51	127 x 254 mm

LVS2 addressable and monitoring system **p. 618**



To help you locate your emergency lighting units with DIALux lighting calculation software, you can download the Legrand plug-in for DIALux on [www.docexport.legrand.com](http://www.docexport.legrand.com)



# U34<sup>LED</sup> environment friendly

indoor self-contained emergency lighting luminaires LED

## Installation

### Surface-mounting

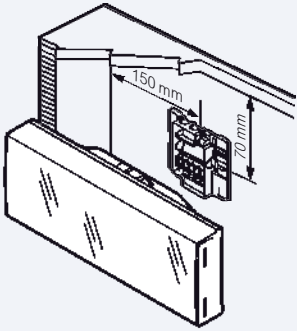

### Slim flush-mounting in dry partitions

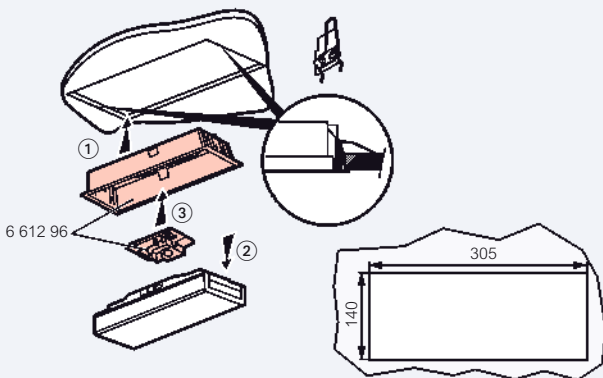

### Flush-mounting with signalling plate in dry partitions

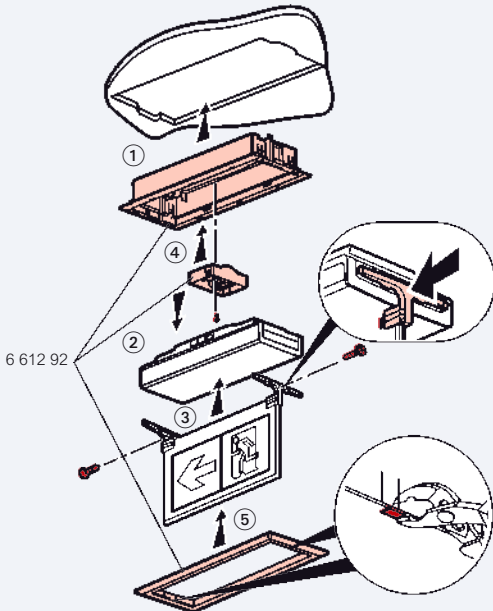

### Flush-mounting in masonry

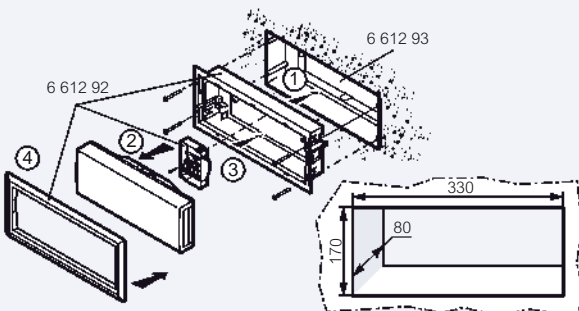

## Dimensions (in mm)

### Surface-mounting

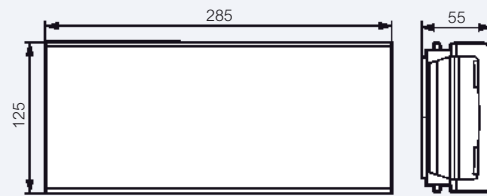

### Plug-in plate

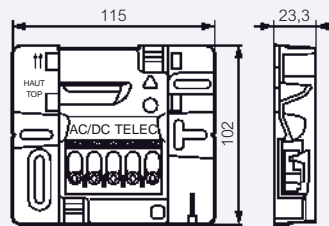

### Lateral cabling accessory

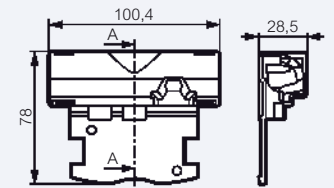

### Slim flush-mounting in dry partitions (Cat.No 6 612 95)

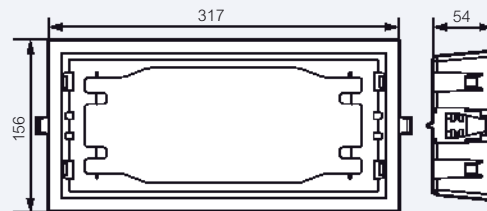

### Flush-mounting in dry partitions (Cat.No 6 612 92)

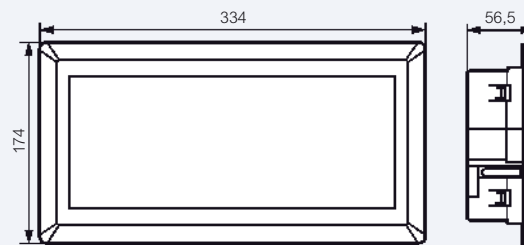

### Flush-mounting in masonry (Cat.No 6 612 92 + 6 612 93)

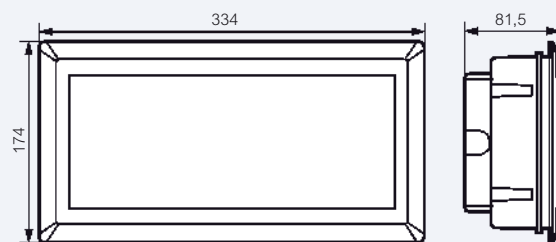

### Signalling plate (Cat.No 6 612 94)

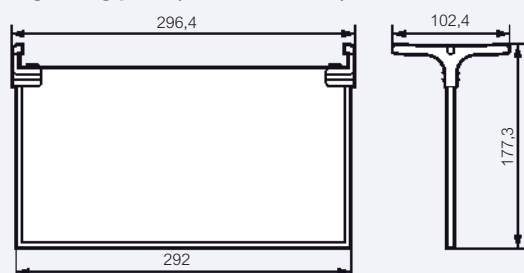



 Spare batteries selection chart **p. 617**  
 Technical characteristics **p. 610**  
 Adhesive labels **p. 616**

LED non-maintained and maintained units  
 Certified to IEC and EN 60598-2-22 standards  
 High power LEDs with optimized lighting distribution  
 Low consumption switching power supply. Fully recyclable  
 Plug-in back with pre-cutted holes grid to ease installation and maintenance  
 Automatic terminals with high capacity: 2 x 2.5 mm<sup>2</sup>. IP 42 - IK 07  
 Duration: 1 and 3 hours. Ni-Cd or Ni-MH batteries. Recharge time: 24 hours  
 Charge monitor with a green LED. Opal diffuser  
 Power supply: 230 V $\sim$   $\pm$  10% - 50/60 Hz. Class II  $\square$   
 Flat flush-mounting integration into ceiling & wall with flush-mounting frame Cat.Nos 6 616 50/51  
 Decorative frame to enhance surface-mounting aesthetic integration Cat.Nos 6 616 54/55

Pack	Cat.Nos	Standard Non maintained luminaires (NM)
1	6 616 20	Standard luminaires require normal lighting manual switching off in order to test emergency lighting Non maintained - 70 lm - 1h (LEDs)
1	6 616 21	Non maintained - 100 lm - 1h (LEDs)
1	6 616 22	Non maintained - 160 lm - 1h (LEDs)
Standard Maintained / Non maintained luminaires (M/NM)		
Standard luminaires require normal lighting manual switching off in order to test emergency lighting These Maintained luminaires can also operate in Non maintained mode according to the wiring of normal lighting		
1	6 616 31	Maintained / Non maintained - 100 lm - 1h (LEDs)
1	6 616 32	Maintained / Non maintained - 160 lm - 1h (LEDs)
1	6 616 33	Maintained / Non maintained - 200 lm - 1h (LEDs)
1	6 616 34	Maintained / Non maintained - 350 lm - 1h (LEDs)
1	6 616 40	Maintained / Non maintained - 100 lm - 3h (LEDs)
Autotest & addressable Maintained luminaires (M)		
Autotest/addressable luminaires incorporate an automatic self-testing system in order to check the emergency mode Tests result is visible on 2 signalling LEDs (green-OK and yellow-defective) Addressable function is activated by setting an ID on each luminaire with infrared configuration tool (Cat.No 0 626 10) and wiring a complementary BUS line. Operating state of all addressable luminaires can be centralized by the control interface (Cat.No 0 626 00) and monitored on a local touch screen controller (Cat.No 0 626 01), or with the building's plan on Legrand Vision System (LVS2) PC software (Cat.No 0 626 02) These Maintained luminaires can also operate in Non maintained mode according to the wiring of normal lighting		
1	6 626 31	Maintained / Non maintained - 100 lm - 1h (LEDs)
1	6 626 33	Maintained / Non maintained - 200 lm - 1h (LEDs)
1	6 626 34	Maintained / Non maintained - 350 lm - 1h (LEDs)
1	6 626 40	Maintained / Non maintained - 100 lm - 3h (LEDs)

Pack	Cat.Nos	Accessories
<b>Decorative frame for surface-mounting installation</b>		
1	6 616 54	White colour
1	6 616 55	Aluminium colour
<b>Slim flush-mounting frame for false ceiling and dry partition</b>		
1	6 616 50	White colour
1	6 616 51	Aluminium colour
<b>Flag-mounting accessory</b>		
1	6 616 58	White colour
1	6 616 59	Aluminium colour
<b>Suspension mounting accessory</b>		
1	6 616 62	White colour
1	6 616 63	Aluminium colour
<b>Signalling plate</b>		
1	6 616 64	Vertical transparent plate for evacuation signalling (must be completed with adhesive evacuation label)
<b>Flush-mounting frame</b>		
1	6 616 65	Special frame with vertical signalling plate

## U21<sup>LED</sup>

indoor self-contained emergency lighting luminaires LED



## U21<sup>NEW</sup> - indoor self-contained emergency lighting

luminaires 6 W fluorescent



6 616 07



6 616 07 + 6 617 20



6 617 02

Spare batteries selection chart **p. 617**  
 Technical characteristics **p. 610**  
 Adhesive labels **p. 616**

LED maintained and non maintained units  
 Certified to IEC and EN 60598-2-22 standards  
 High power LEDs  
 IP 42 - IK 04  
 Duration: 1 and 3 hours  
 Ni-Cd or Ni-MH batteries  
 Recharge time: 24 hours  
 Charge monitor with a green LED  
 Power supply: 230 V $\sim$   $\pm$  10% - 50/60 Hz  
 Class II  $\square$   
 High capacity screw terminals (2 x 2.5 mm<sup>2</sup>)  
 Flush-mounting in dry partitions (ceiling & wall): add flush-mounting frame  
 Cat.No 6 617 20  
 Flush-mounting in masonry (brick or concrete wall): add both flush-mounting  
 box Cat.No 0 617 21 and flush-mounting frame Cat.No 6 617 20  
 To be equipped with labels (p. 608)  
 Can be equipped with metallic protection grids Cat.Nos 0 626 90/92 (p. 616)

Spare batteries selection chart **p. 617**  
 Technical characteristics **p. 610**  
 Adhesive labels **p. 616**

6 W fluorescent non-maintained and combined units  
 Certified to IEC and EN 60598-2-22 standards  
 IP 42 - IK 04  
 Power supply: 230 V $\sim$   $\pm$  10%  
 Plug-in base to ease fixing, cabling and connection  
 Transparent diffuser  
 Duration time: 1, 2 and 3 hours  
 Ni-Cd batteries  
 Recharge time: 24 hours  
 Green LED charge monitor  
 High capacity screw terminals (2 x 2.5 mm<sup>2</sup>)  
 Flush mounting in dry partitions (ceiling): add flush-mounting frame  
 Cat.No 6 617 20  
 Flush mounting in masonry (brick or concrete wall): add both flush-  
 mounting box Cat.No 0 617 21 and flush-mounting frame Cat.No 6 617 20  
 To be equipped with labels (p. 608)  
 Can be equipped with metallic protection grids Cat.Nos 0 626 90/92 (p. 616)

### Pack Cat.Nos **Standard Non maintained luminaires (NM)**

Pack	Cat.Nos	Description
1	6 616 01	Standard luminaires require normal lighting manual switching off in order to test emergency lighting
1	6 616 02	Non maintained - 70 lm - 1h (LEDs)
1	6 616 05	Non maintained - 100 lm - 1h (LEDs)
1	6 616 05	Non maintained - 160 lm - 1h (LEDs)

### **Standard Maintained luminaires (M)**

Pack	Cat.Nos	Description
1	6 616 03	Standard luminaires require normal lighting manual switching off in order to test emergency lighting These Maintained luminaires can also operate in Non maintained mode according to the wiring of normal lighting
1	6 616 06	Maintained / Non maintained - 100 lm - 1h (LEDs)
1	6 616 06	Maintained / Non maintained - 200 lm - 1h (LEDs)
1	6 616 07	Maintained / Non maintained - 350 lm - 1h (LEDs)
1	6 616 10	Maintained / Non maintained - 100 lm - 3h (LEDs)

### **Autotest & addressable Maintained luminaires (M)**

Pack	Cat.Nos	Description
1	6 626 03	Autotest/addressable luminaires incorporate an automatic self-testing system in order to check the emergency mode. Tests result is visible on 2 signalling LEDs (green-OK and yellow-defective) Addressable function is activated by setting an ID on each luminaire with configuration tool (Cat.No 0 626 10) and wiring a complementary BUS line. Operating state of all addressable luminaires can be centralized by the control interface (Cat.No 0 626 00) and monitored on a local touch screen controller (Cat.No 0 626 01), or with the building's plan on Legrand Vision System (LVS2) PC software (Cat.No 0 626 02). These Maintained luminaires can also operate in Non maintained mode according to the wiring of normal lighting
1	6 626 03	Maintained / Non maintained - 100 lm - 1h (LEDs)
1	6 626 06	Maintained / Non maintained - 200 lm - 1h (LEDs)
1	6 626 07	Maintained / Non maintained - 350 lm - 1h (LEDs)
1	6 626 10	Maintained / Non maintained - 100 lm - 3h (LEDs)

### **Accessories**

1	6 617 20	Flush-mounting frame for dry partition
1	0 617 21	Flush-mounting box for masonry partition

To help you locate your emergency lighting units with DIALux lighting calculation software, you can download the Legrand plug-in for DIALux on [www.export.legrand.com/EN](http://www.export.legrand.com/EN)

### Pack Cat.Nos **Standard luminaires**

Pack	Cat.Nos	Description
1	6 617 10	Standard luminaires require normal lighting manual switching off in order to test emergency lighting
1	6 617 01	Non-maintained 6 W fluorescent luminaires
1	6 617 01	Non maintained - 50 lm - 1h (1 x 6 W)
1	6 617 01	Non maintained - 70 lm - 1h (1 x 6 W)
1	6 617 02	Non maintained - 110 lm - 1h (1 x 6 W)
1	6 617 05	Non maintained - 160 lm - 1h (1 x 6 W)
1	6 617 06	Non maintained - 240 lm - 1h (1 x 6 W)
1	6 617 07	Non maintained - 300 lm - 1h (1 x 6 W)
1	6 617 11	Non maintained - 90 lm - 3h (1 x 6 W)
1	6 617 09	<b>Combined 2 x 6 W fluorescent luminaire</b> Combined - 160 lm - 1h (2 x 6 W)

### **Autotest/Addressable luminaires**

10	6 627 02	Autotest/addressable luminaires incorporate an automatic self-testing system in order to check the emergency mode Tests result is visible on 2 signalling LEDs (green-OK and yellow-defective) Addressable function is activated by setting an ID on each luminaire on internal microswitches and wiring a complementary BUS line Operating state of all addressable luminaires can be centralized by the control interface (Cat.No 0 626 00) and monitored on a local touch screen controller (Cat.No 0 626 01), or with the building's plan on Legrand Vision System (LVS2) PC software (Cat.No 0 626 02)
10	6 627 02	Non-maintained 6 W fluorescent luminaires
10	6 627 02	Non maintained - 100 lm - 1h (1 x 6 W)
10	6 627 05	Non maintained - 160 lm - 1h (1 x 6 W)
10	6 627 06	Non maintained - 200 lm - 1h (1 x 6 W)
10	6 627 07	Non maintained - 310 lm - 1h (1 x 6 W)
10	6 627 14	Non maintained - 100 lm - 3h (1 x 6 W)
1	6 627 09	<b>Combined 2 x 6 W fluorescent luminaires</b>
10	6 627 15	Combined - 160 lm - 1h (2 x 6 W) Combined - 100 lm - 3h (2 x 6 W)

### **Accessories**

1	6 617 20	Flush mounting frame for dry partition
1	0 617 21	Flush mounting box for masonry partition

To help you locate your emergency lighting units with DIALux lighting calculation software, you can download the Legrand plug-in for DIALux on [www.export.legrand.com/EN](http://www.export.legrand.com/EN)

**URA ONE, U21<sup>LED</sup> and U21<sup>NEW</sup>**

indoor self-contained emergency lighting luminaires

**URA ONE**

**Installation**

Surface-mounting

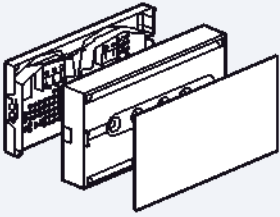

Flush-mounting with slim frame  
Cat.Nos 6 616 50/51



Surface-mounting with  
vertical signalling plate  
Cat.No 6 616 64

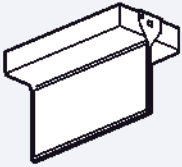

Flush-mounting with vertical  
signalling plate Cat.No 6 616 65

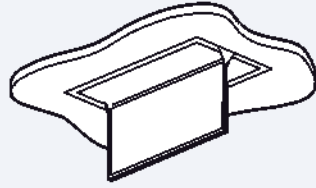

**Dimensions (in mm)**

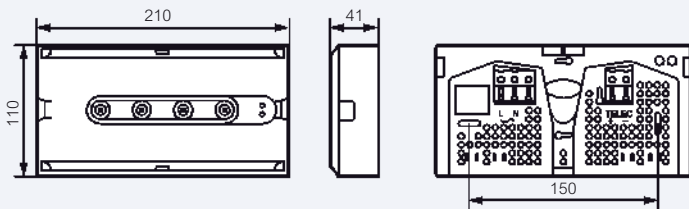

**Accessories**

Flush-mounting with slim frame Cat.No 6 616 50/51

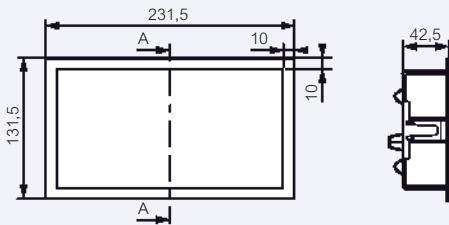

Vertical signalling plate Cat.No 6 616 64



Special flush-mounting with vertical signalling plate Cat.No 6 616 65

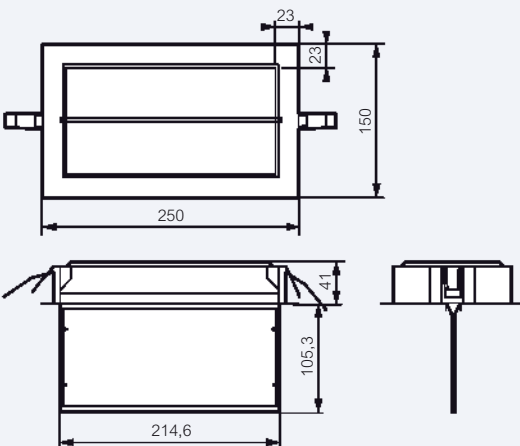

**U21<sup>LED</sup>**

**Surface-mounting installation**

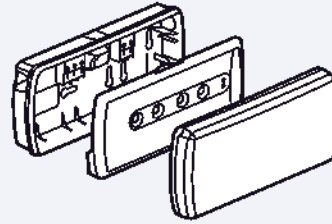

**Dimensions (in mm)**

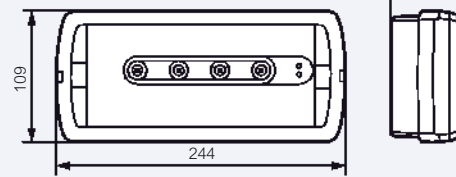

**U21<sup>NEW</sup>**

**Surface-mounting installation**

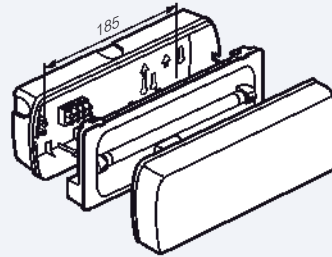

**Dimensions (in mm)**

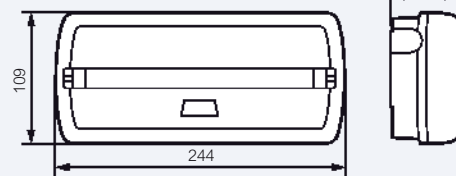

**U21<sup>LED</sup> and U21<sup>NEW</sup> accessories**

**Flush-mounting with Cat.No 6 617 20**

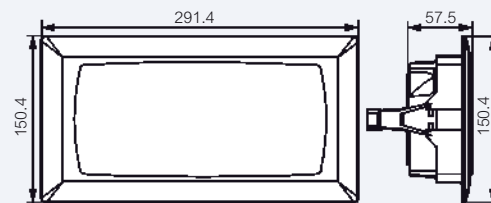

**Flush-mounting cut-out in dry partitions with Cat.No 6 617 20**



**Flush-mounting cut-out in masonry with Cat.Nos 6 617 20 + 0 617 21**

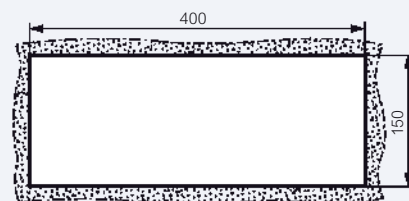

## INOX<sup>LED</sup> - weatherproof self-contained emergency lighting luminaires for special uses



6 625 60

Spare batteries selection chart **p. 617**  
 Technical characteristics **p. 613**

To be equipped with labels (p. 616)

Pack	Cat.Nos	LED maintained/non maintained weatherproof luminaires
		High power LEDs with specially designed lens optimizing the lighting distribution Power supply 230 V +/- 10% 50/60 Hz Very low consumption switching power supply Environment friendly Ni-MH batteries Recharge time: 24 hours
1	6 625 60	<b>IP 67 plastic/stainless steel industrial &amp; architectural luminaires - Autotest/addressable</b> Maintained/non maintained - 400 lm - 1 h (LEDs)
1	6 625 61	Maintained/non maintained - 200 lm - 3 h (LEDs)

## B66<sup>LED</sup> environment friendly weatherproof self-contained emergency lighting luminaires LED



6 615 41

Spare batteries selection chart **p. 617**  
 Technical characteristics **p. 613**  
 Adhesive labels **p. 616**

Pack	Cat.Nos	B66 <sup>LED</sup>
		LED maintained/non maintained weatherproof luminaires High power LEDs with specially designed lens optimizing the lighting distribution IP 66 - High protection level IK 10 - Very high resistance level against mechanical shocks Class II Power supply: 230 V ± 10% - 50/60 Hz Very low consumption switching power supply Environment friendly Ni-MH batteries Recharge time: 24 hours Plug-in back with automatic high capacity terminals: 2 x 2.5 mm <sup>2</sup> Diffuser with tool-less fast mounting Charge monitor with a green LED Can be equipped with metallic protection grids Cat.Nos 0 626 92/93 (p. 616) To be equipped with labels (p. 616)
		<b>Standard luminaires - 1 h duration with transparent diffuser</b> Standard luminaires incorporate an external lamp test with testing tool Cat.No 6 612 99
1	6 615 41	Maintained/Non maintained - 100 lm - 1h (LEDs)
1	6 615 43	Maintained/Non maintained - 250 lm - 1h (LEDs)
1	6 615 45	Maintained/Non maintained - 450 lm - 1h (LEDs)
		<b>Autotest/Addressable luminaires - 1 h duration with transparent diffuser</b> Autotest/addressable luminaires incorporate an automatic self-testing system Tests result is visible on 2 signalling LEDs (green-OK and yellow-defective) Addressable function is activated by setting an ID on each luminaire with infrared configuration tool (Cat.No 0 626 10) and wiring a complementary BUS line Operating state of all addressable luminaires can be centralized by the control interface (Cat.No 0 626 00) and monitored on a local touch screen controller (Cat.No 0 626 01), or with the building's plan on Legrand Vision System (LVS2) PC software Cat.No 0 626 02
1	6 625 43	Maintained/Non maintained - 250 lm - 1h (LEDs)
1	6 625 45	Maintained/Non maintained - 450 lm - 1h (LEDs)
		<b>Accessories</b>
1	6 612 99	<b>Testing tool</b> Testing tool for U34 LED, U33, B66 LED and B66 standard luminaires
1	0 609 10	<b>Screwdriver socket</b> Vandal resistant screwdriver socket compatible with Cat.Nos 0 626 92 and 0 626 99 For vandal resistant screws
1	0 626 99	<b>Vandal resistant screws for emergency lighting luminaires</b> Set of 4 screws making the diffuser's locking clips impregnable (4 screws are necessary per luminaire) Require the use of screwdriver Cat.No 0 609 10 (not supplied)

To help you locate your emergency lighting units with DIALux lighting calculation software, you can download the Legrand plug-in for DIALux on [www.export.legrand.com/EN](http://www.export.legrand.com/EN)

## B65<sup>LED</sup> - weatherproof self-contained emergency lighting luminaire LED



## B65<sup>NEW</sup> - weatherproof self-contained emergency lighting luminaires 6 W / 11 W fluorescent



6 614 33

Spare batteries selection chart **p. 617**

Weatherproof LED maintained and non maintained units  
 Certified to IEC and EN 60598-2-22 standards  
 High power LEDs  
 IP 65 - IK 07  
 Plug-in base to ease fixing, cabling and connection  
 Duration: 1 and 3 hours  
 Ni-Cd or Ni-MH batteries  
 Recharge time: 24 hours  
 Charge monitor with a green LED  
 Power supply: 230 V ± 10% - 50/60 Hz  
 Class II   
 High-capacity screw terminals (2 x 2.5 mm<sup>2</sup>)  
 3 flexible cable entries for Ø16, 20 and 25 mm tubes  
 To be equipped with labels (p. 608)  
 Can be equipped with metallic protection grids Cat.Nos 0 626 90/92 (p. 616)

Pack	Cat.Nos	Standard Maintained luminaires (M)
		Standard luminaires require normal lighting manual switching off in order to test emergency lighting These Maintained luminaires can also operate in Non maintained mode according to the wiring of normal lighting
1	6 614 31	Maintained / Non maintained - 100 lm - 1h (LEDs)
1	6 614 33	Maintained / Non maintained - 200 lm - 1h (LEDs)
1	6 614 34	Maintained / Non maintained - 350 lm - 1h (LEDs)
1	6 614 40	Maintained / Non maintained - 100 lm - 3h (LEDs)

Pack	Cat.Nos	Autotest & addressable Maintained luminaires (M)
		Autotest/addressable luminaires incorporate an automatic self-testing system in order to check emergency lighting Tests result is visible on 2 signalling LEDs (green-OK and yellow-defective) Addressable function is activated by setting an ID on each luminaire with configuration tool (Cat.No 0 626 10) and wiring a complementary BUS line Operating state of all addressable luminaires can be centralized by the control interface (Cat.No 0 626 00) and monitored on a local touch screen controller (Cat.No 0 626 01), or with the building's plan on Legrand Vision System (LVS2) PC software Cat.No 0 626 02 These Maintained luminaires can also operate in Non maintained mode according to the wiring of normal lighting
1	6 624 31	Maintained / Non maintained - 100 lm - 1h (LEDs)
1	6 624 33	Maintained / Non maintained - 200 lm - 1h (LEDs)
1	6 624 34	Maintained / Non maintained - 350 lm - 1h (LEDs)
1	6 624 40	Maintained / Non maintained - 100 lm - 3h (LEDs)



6 614 03

Spare batteries selection chart **p. 617**

6 W and PL 11 W fluorescent non-maintained and combined units  
 Certified to IEC and EN 60598-2-22 standards  
 IP 65 - IK 07  
 Class II  
 Power supply: 230 V ± 10%  
 Plug-in base to ease fixing, cabling and connection  
 Transparent diffuser  
 Duration time: 1 and 2 hours  
 Ni-Cd batteries  
 Recharge time: 24 hours  
 Green LED charge monitor  
 High-capacity screw terminals (2 x 2.5 mm<sup>2</sup>)  
 3 flexible cable entries for Ø16, 20 and 25 mm tubes  
 To be equipped with labels (p. 608)  
 Can be equipped with metallic protection grids Cat.Nos 0 626 90/92 (p. 616)

Pack	Cat.Nos	Standard luminaires
		<b>Non-maintained 6 W and 11 W fluorescent luminaires</b>
1	6 614 01	Non maintained - 100 lm - 1h (1 x 6 W)
1	6 614 02	Non maintained - 170 lm - 1h (1 x 6 W)
1	6 614 03	Non maintained - 300 lm - 1h (1 x 6 W)
1	6 614 04	Non maintained - 450 lm - 1h (1 x 11 W)
		<b>Combined 2 x 6 W fluorescent luminaires</b>
1	6 614 23	Combined - 100 lm - 1h (2 x 6 W)
1	6 614 24	Combined - 250 lm - 1h (2 x 6 W)

Pack	Cat.Nos	Autotest/Addressable luminaires
		Autotest/addressable luminaires incorporate an automatic self-testing system Tests result is visible on 2 signalling LEDs (green-OK and yellow-defective) Addressable function is activated by setting an ID on each luminaire on internal microswitches and wiring a complementary BUS line Operating state of all addressable luminaires can be centralized by the control interface (Cat.No 0 626 00) and monitored on a local touch screen controller (Cat.No 0 626 01), or with the building's plan on Legrand Vision System (LVS2) PC software Cat.No 0 626 02
		<b>Non-maintained 6 W and 11 W fluorescent luminaires</b>
1	6 624 01	Non maintained - 100 lm - 1h (1 x 6 W)
1	6 624 02	Non maintained - 170 lm - 1h (1 x 6 W)
1	6 624 03	Non maintained - 300 lm - 1h (1 x 6 W)
1	6 624 04	Non maintained - 450 lm - 1h (1 x 11 W)
		<b>Combined 2 x 6 W fluorescent luminaires</b>
1	6 624 23	Combined - 100 lm - 1h (2 x 6 W)
1	6 624 24	Combined - 250 lm - 1h (2 x 6 W)

To help you locate your emergency lighting units with DIALux lighting calculation software, you can download the Legrand plug-in for DIALux on [www.export.legrand.com/EN](http://www.export.legrand.com/EN)

# INOX<sup>LED</sup>, B66<sup>LED</sup>, B65<sup>LED</sup> and B65<sup>NEW</sup>

## B66<sup>LED</sup>

### Surface-mounting installation

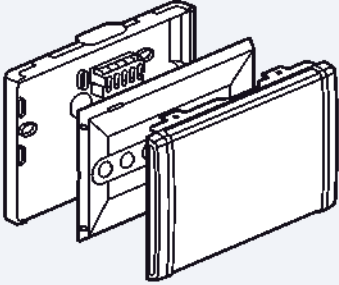

### Dimensions (in mm)

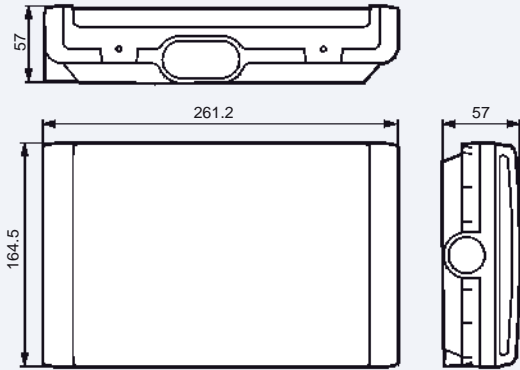

## INOX<sup>LED</sup> - Dimensions (in mm)

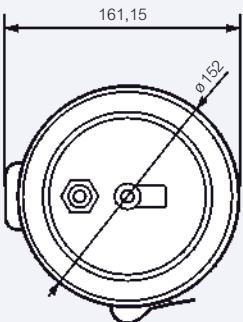
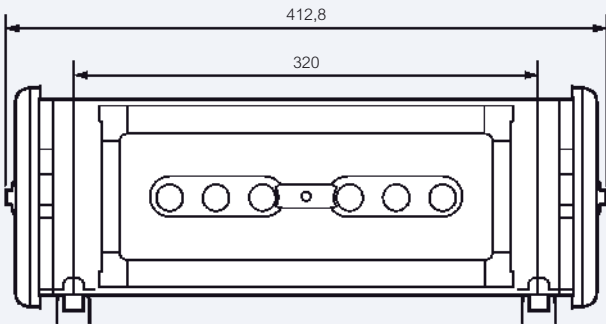

## B65<sup>LED</sup>/B65<sup>NEW</sup>

### Surface-mounting installation

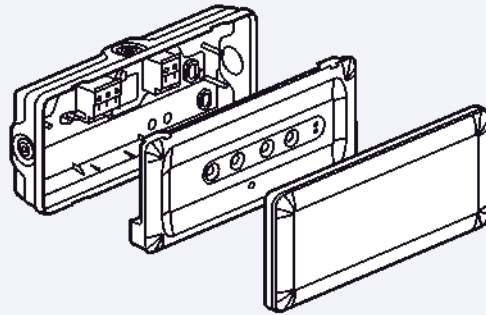

### B65<sup>NEW</sup>

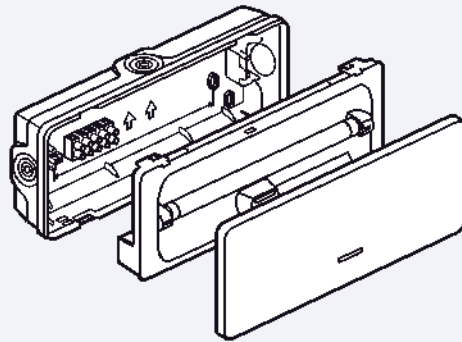

### Dimensions (in mm)

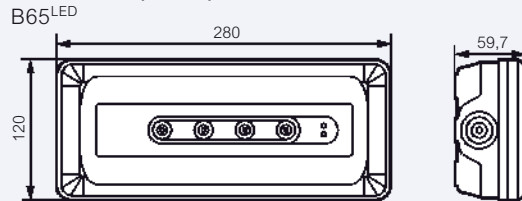

### B65<sup>NEW</sup>

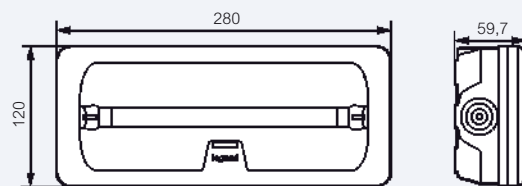

**S8 - indoor standard self-contained emergency lighting**  
**luminaires 8 W fluorescent - BS compliant**



0 660 00



0 660 01 + 6 608 66



0 660 03 + 0 660 90



0 660 01 + 0 660 90 + 0 660 92 +  
0 610 01

Spare batteries selection chart **p. 617**

Can be equipped with metallic protection grid Cat.Nos 0 626 91 (p. 616)

Pack	Cat.Nos	8 W fluorescent non-maintained, maintained and combined units
		Certified to IEC 60598-2-22 and EN 60598-2-22 standards IP 42 Class II Power supply: 230 V +/- 10 % - 50/60 Hz Lamp and emergency operation test with a push-button Ni-Cd batteries Recharge time: 24 hours High capacity screw terminals: 2 x 2.5 mm <sup>2</sup> Charge monitor with a green LED
		<b>1 h duration - 140 lm</b>
1	0 660 00	Non maintained - 140 lm - 1h (1 x 8 W)
1	0 660 01	Maintained - 140 lm - 1h (1 x 8 W)
1	0 660 02	Combined - 140 lm - 1h (2 x 8 W)
		<b>3 h duration - 110 lm</b>
1	0 660 03	Non maintained - 110 lm - 3h (1 x 8 W)
1	0 660 04	Maintained - 110 lm - 3h (1 x 8 W)
1	0 660 05	Combined - 110 lm - 3h (2 x 8 W)
		<b>Accessories</b>
1	0 660 90	Flush-mounting frame
1	0 660 92	Double-sided diffuser

**S8 - indoor standard self-contained emergency lighting**  
**luminaires 8 W fluorescent**

**■ Dimensions (in mm)**

**Surface mounting**

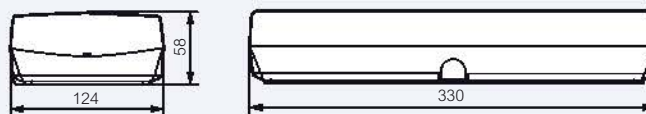

**Ceiling mounting with double-sided diffuser**

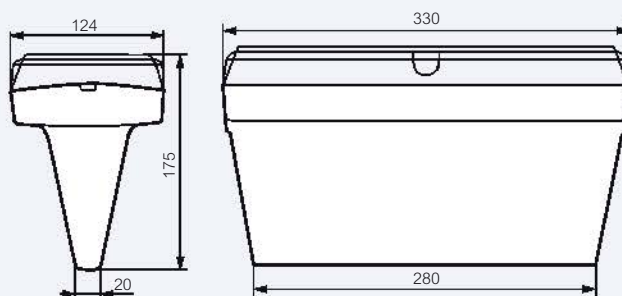

**Flush-mounting**

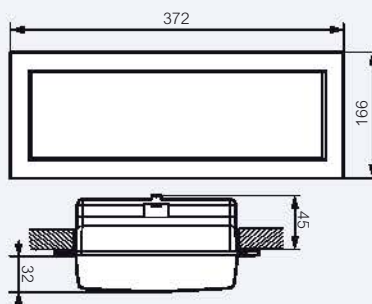

**With double-sided diffuser**

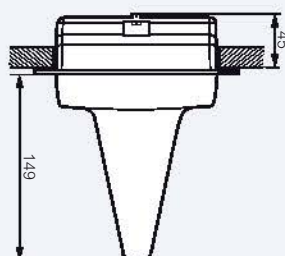

To help you locate your emergency lighting units with DIALux lighting calculation software, you can download the Legrand plug-in for DIALux on [www.export.legrand.com/EN](http://www.export.legrand.com/EN)



## B66 - weatherproof self-contained emergency lighting luminaires 8 W / 11 W fluorescent - BS compliant



6 615 21

Spare batteries selection chart **p. 617**

Pack	Cat.Nos	8 W / 11 W fluorescent luminaires
		8 W and PL11 W fluorescent non maintained, maintained and combined luminaires Certified to IEC 60598-2-22 and EN 60598-2-22 standards. IP 66 - High protection level IK 08 - High resistance level against mechanical shock Class II. Power supply: 230 V ± 10% - 50/60 Hz Low consumption switching power supply Ni-Cd batteries. Recharge time: 24 hours Plug-in back with automatic high capacity terminals: 2 x 2.5 mm <sup>2</sup> . Diffuser with tool-less fast mounting Charge monitor with a green LED Can be equipped with metallic protection grid Cat.No 0 626 91 (p. 616)
		<b>Standard luminaires - 1 h duration with transparent diffuser</b> Luminaires incorporate an external manual lamp test
1	6 615 21	Non maintained - 100 lm - 1h (1 x 8 W)
1	6 615 23	Non maintained - 250 lm - 1h (1 x 8 W)
1	6 615 25	Non maintained - 450 lm - 1h (1 x 11 W)
1	6 615 01	Maintained - 100 lm - 1h (1 x 8 W)
1	6 615 11	Maintained - 250 lm - 1h (1 x 8 W)
1	6 615 02	Combined - 100 lm - 1h (2 x 8 W)
1	6 615 12	Combined - 250 lm - 1h (2 x 8 W)
		<b>Standard luminaires - 3 h duration with transparent diffuser</b> Luminaires incorporate an external manual lamp test
1	6 615 35	Non maintained - 150 lm - 3h (1 x 8 W)
1	6 615 36	Maintained - 150 lm - 3h (1 x 8 W)
1	6 615 37	Combined - 150 lm - 3h (2 x 8 W)
		<b>Autotest/Addressable luminaires - 1 h duration with transparent diffuser</b> Autotest/addressable luminaires incorporate an automatic self-testing system in order to test the emergency mode Tests result is visible on 2 signalling LEDs (green-OK and yellow-defective). Addressable function is activated by setting an ID on each luminaire with infrared configuration tool (Cat.No 0 626 10) and wiring a complementary BUS line. Operating state of all addressable luminaires can be centralized by the control interface (Cat.No 0 626 00) and monitored on a local touch screen controller (Cat.No 0 626 01), or with the building's plan on Legrand Vision System (LVS2) PC software Cat.No 0 626 02
1	6 625 21	Non maintained - 100 lm - 1h (1 x 8 W)
1	6 625 23	Non maintained - 250 lm - 1h (1 x 8 W)
1	6 625 25	Non maintained - 450 lm - 1h (1 x 11 W)
1	6 625 01	Maintained - 250 lm - 1h (1 x 8 W)
1	6 625 06	Maintained - 400 lm - 1h (1 x 8 W)
1	6 625 02	Combined - 250 lm - 1h (2 x 8 W)
1	6 625 07	Combined - 400 lm - 1h (2 x 8 W)
		<b>Accessories</b>
1	6 612 99	<b>Testing tool</b> Testing tool for U34 LED, U33, B66 LED and B66 standard luminaires
1	0 609 10	<b>Screwdriver socket</b> Vandal resistant screwdriver socket compatible with Cat.Nos 0 626 92 and 0 626 99 For vandal resistant screws
1	0 626 99	<b>Vandal resistant screws for emergency lighting luminaires</b> Set of 4 screws making the diffuser's locking clips impregnable (4 screws are necessary per luminaire) Require the use of screwdriver Cat.No 0 609 10 (not supplied)

## B66 - weatherproof self-contained emergency lighting luminaires 8 W / 11 W fluorescent

### ■ Surface-mounting installation

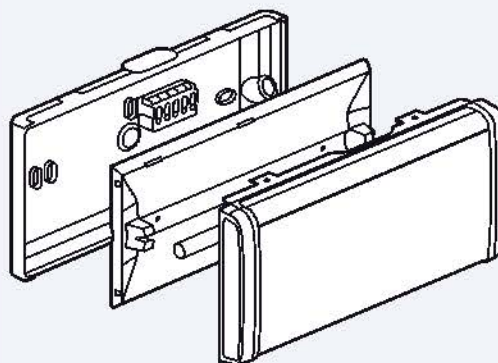

### ■ Dimensions in mm

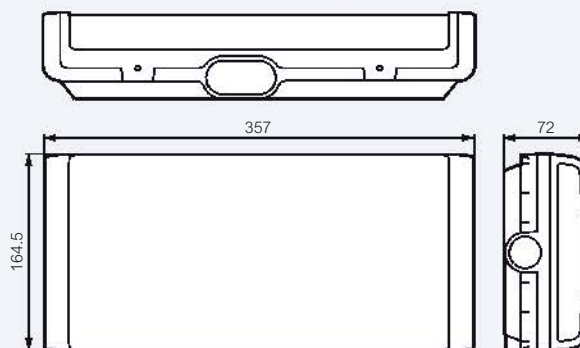

To help you locate your emergency lighting units with DIALux lighting calculation software, you can download the Legrand plug-in for DIALux on [www.export.legrand.com/EN](http://www.export.legrand.com/EN)

## LED portable lamp and spare parts



0 607 97



0 609 41

Pack	Cat.Nos	LED portable lamp
1	0 607 97	Manual switching ON/OFF with 3 lighting levels: - 20 lumen / 3h duration - 40 lumen / 1h30 duration - 60 lumen / 1h duration Ni-MH built-in battery pack Supplied with separate 12 V DC battery charger and mains connector Power supply: 230 V +/- 10% - 50/60 Hz IP 40 - IK 07 Class II

Lamps and tubes		
Lamps - E10		
25	0 609 28	12 V - 0.25 A - 3 W (E 10)
10	0 609 29	6 V - 0.9 A - 5.5 W (E 10)
25	0 609 31	3.6 V - 1 A - 3.6 W (E 10)

Tubes		
1	0 609 40	6 W
1	0 609 41	8 W
1	0 607 53	11 W

Metallic protection grids		
Shock resistance: 20 joules Fastening holes on 4 sides		
1	0 626 90	For IP 43 emergency lighting luminaires LED
1	0 626 91	For IP 43 and IP 66 emergency lighting luminaires 8 W
1	0 626 93	For IP 43 and IP 66 emergency lighting luminaires LED

IK 20 vandal resistant grid		
1	0 626 92	For IP 43 and IP 66 emergency lighting luminaires LED High shock resistance: 50 joules Particularly suitable for protecting lighting luminaires in parking lots and buildings subject to vandalism Double fixing system via: - wall-mounting base, to be mounted on metallic frame with 4 metallic wall plugs - locking of the grid on metallic frame with vandal resistant screws requiring the use of tool Cat.No 0 609 10 (not supplied)

## Labels

for emergency lighting luminaires



0 612 00

Pack	Cat.Nos	Adhesive labels for URA ONE, U21 <sup>LED</sup> , U21 <sup>NEW</sup> , B65 <sup>LED</sup> and B65 <sup>NEW</sup> ranges
5	6 616 70	100 x 200 mm
5	6 616 71	100 x 200 mm
5	6 616 72	100 x 200 mm
5	6 616 80	100 x 200 mm
5	6 616 88	100 x 200 mm
5	6 616 90	100 x 200 mm
5	6 616 91	100 x 200 mm

Adhesive labels for U34 <sup>LED</sup> and B66 <sup>LED</sup> ranges		
5	0 612 00	327 x 109 mm
5	0 612 01	327 x 109 mm
5	0 612 02	327 x 109 mm

Adhesive labels for INOX <sup>LED</sup> , S8 and B66 ranges		
5	6 608 65	310 x 112 mm
5	6 608 66	310 x 112 mm
5	6 608 67	310 x 112 mm
5	6 608 69	310 x 112 mm
5	6 608 74	310 x 112 mm
5	6 608 75	310 x 112 mm
5	6 608 76	310 x 112 mm

# Self-contained emergency lighting luminaires

spare batteries

CURRENT EMERGENCY LIGHTING LUMINAIRES		BS-COMPLIANT	
Emergency lighting luminaire Cat.No	Spare part battery Cat.No	Emergency lighting luminaire Cat.No	Spare part battery Cat.No
<b>U34<sup>LED</sup></b>		<b>B66<sup>LED</sup></b>	
6 611 60	6 609 61	6 615 41	0 610 97
6 611 80	0 610 96	6 615 43	0 610 97+ 6 609 64
6 611 90	0 610 96	6 615 45	0 610 98
6 621 60	6 609 61	6 625 43	0 610 97+ 6 609 64
6 621 80	0 610 96	6 625 45	0 610 98
6 621 90	0 610 96	<b>INOX<sup>LED</sup></b>	
<b>URA ONE</b>		6 625 60	0 610 96
6 616 20	0 610 87	6 625 61	0 610 96
6 616 21	0 610 92	<b>B65<sup>NEW</sup></b>	
6 616 22	6 609 72	6 614 01	0 617 97
6 616 31	0 610 92	6 614 02	0 618 82
6 616 32	6 609 72	6 614 03	0 618 85
6 616 33	6 609 72	6 614 04	0 618 86
6 616 34	6 609 62	6 614 09	0 618 86
6 616 40	6 609 71	6 614 23	0 617 97
6 626 31	6 609 72	6 614 24	0 618 85
6 626 33	6 609 62	6 624 01	0 618 82
6 626 34	6 609 71	6 624 02	6 609 69
6 626 40	6 609 71	6 624 03	6 609 63
<b>U21<sup>LED</sup></b>		6 624 04	6 609 67
6 616 01	0 610 87	6 624 09	6 609 67
6 616 02	0 610 92	6 624 23	0 618 82
6 616 03	0 610 92	6 624 24	6 609 63
6 616 05	6 609 72	<b>B65<sup>LED</sup></b>	
6 616 06	6 609 72	6 614 31	0 610 92
6 616 07	6 609 62	6 614 33	6 609 72
6 616 10	6 609 71	6 614 34	6 609 62
6 626 03	6 609 72	6 614 40	6 609 71
6 626 06	6 609 62	6 624 31	6 609 72
6 626 07	6 609 71	6 624 33	6 609 62
6 626 10	6 609 71	6 624 34	6 609 71
<b>U21<sup>NEW</sup></b>		6 624 40	6 609 71
6 617 01	0 617 97	<b>B66</b>	
6 617 02	0 617 97	6 615 01	0 610 92
6 617 05	0 618 82	6 615 02	0 610 92
6 617 06	0 618 84	6 615 11	6 609 62
6 617 07	0 618 85	6 615 12	6 609 62
6 617 09	0 618 82	6 615 21	0 610 92
6 617 10	0 617 97	6 615 23	6 609 62 + 0 610 92
6 617 11	0 618 85	6 615 25	0 610 93
6 617 12	0 618 85	6 615 35	6 609 62 + 6 609 70
6 617 13	0 618 84	6 615 36	6 609 62 + 6 609 70
6 627 02	0 618 82	6 615 37	6 609 62 + 6 609 70
6 627 05	6 609 69	6 625 01	6 609 62 + 0 610 92
6 627 06	0 618 85	6 625 02	6 609 62 + 0 610 92
6 627 07	6 609 63	6 625 06	0 610 93
6 627 09	6 609 69	6 625 07	0 610 93
6 627 14	6 609 63	6 625 21	6 609 62
6 627 15	6 609 63	6 625 23	6 609 62 + 0 610 92
		6 625 25	2 x 6 609 66
		<b>S8</b>	
		0 660 00	0 618 83
		0 660 01	0 618 83
		0 660 02	0 618 83
		0 660 03	0 618 85
		0 660 04	0 618 85
		0 660 05	0 618 85



Batteries for old ranges U21, U33, B65, L31, NT65 and G5, see e-catalogue



# LVS2 (Legrand Vision System)

addressable & monitoring system



0 626 00



0 626 10



0 626 01 + 0 791 74



0 626 03

Pack	Cat.Nos	Control interface for autotest/addressable luminaires
1	0 626 00	<p>Centralises the operating state of addressable emergency lighting luminaires Communication between the addressable luminaires and the control interface is carried out via a BUS line</p> <ul style="list-style-type: none"> <li>Capacity</li> </ul> <p>Direct connection of 250 addressable luminaires to the control interface (star configuration or series connection) The longest line is limited to 700 m Extension via repeater Cat.No 0 626 03 for more than 250 addressable luminaires or a line longer than 700 m Maximum capacity of the central control panel: 1023 addressable luminaires Configuration software included (control interface settings and ID configuration for addressable luminaires) To be completed with at least one of the following terminals:</p> <ul style="list-style-type: none"> <li>- PC with monitoring software Cat.No 0 626 02</li> <li>- Touch screen controller Cat.No 0 626 01</li> <li>- PC with internet navigator (limited functions)</li> </ul> <ul style="list-style-type: none"> <li>Connections:</li> </ul> <ul style="list-style-type: none"> <li>- RJ 45 socket for IP network</li> <li>- terminals for RS 232 and RS 485</li> <li>- Mini USB for PC local settings</li> </ul> <ul style="list-style-type: none"> <li>Power supply:</li> </ul> <ul style="list-style-type: none"> <li>- 230 V<math>\sim</math> - 50/60 Hz</li> <li>- Ni-Cd battery: 8.4 V - 0.15 Ah</li> </ul>
1	0 626 10	<p><b>Mobile infrared configuration tool</b></p> <p>For assigning an ID to each addressable luminaire in order to control operating state with control interface Cat.No 0 626 00</p>

Pack	Cat.Nos	3.5" touch screen controller
1	0 626 01	<p>For controlling the operating state of a global addressable luminaires installation To be used complementary to the control interface Cat.No 0 626 00 Connected to the control interface through IP infrastructure Display of:</p> <ul style="list-style-type: none"> <li>- defect type</li> <li>- defect units location</li> <li>- alarms and operating mode settings</li> </ul> <p>Power supply voltage: 27 V 600 mA with a separate power supply Cat.No 0 634 42 To be equipped with white plate Cat.No 0 784 70 or aluminium plate Cat.No 0 791 74 (support) To be mounted in flush-mounting box Cat.No 0 801 24</p>
1	0 626 02	<p><b>Monitoring PC software</b></p> <p>For supervising an installation equipped with addressable self-contained emergency lighting luminaires and control interface(s) Cat.No 0 626 00, whatever the installation size Simultaneous monitoring of one or several whole establishments, made of several buildings, according to the construction configuration (tree structure by buildings, levels, floors or zones) Emergency lighting location displayed on background plans of each zone of the building Background plans imported in DWG (AutoCAD) or DXF vector format, or image format (JPEG, GIF, ...) Overview screen of the luminaires installation operating state Functions for maintenance assistance:</p> <ul style="list-style-type: none"> <li>- print-out of the spare parts list</li> <li>- print-out of a maintenance document locating each defect luminaire and detailing the repair operations</li> </ul> <p>Automatic periodic sending of the installation state report Export of background plans with emergency lighting location in PDF or DXF format Multi-user software</p>
1	0 626 03	<p><b>Repeater</b></p> <p>For extending the installation beyond 250 units or for a line &gt; 700 m (on control interface or repeater) up to 250 additional luminaires and on the longest line &lt; 700 m Class II Power supply: 230 VA - 50/60 Hz Ni-Cd battery: 8.4 V - 0.15 Ah Dim.: 6 x 17.5 mm modules</p>
1	0 634 42	<p><b>Additional power supply</b></p> <p>Power supply 220-240 V - 50/60 Hz Output 1-2 27 V<math>\pm</math> - 600 mA Dim.: 2 x 17.5 mm modules New Cat.No 3 460 20</p>

# LVS2 (Legrand Vision System)

addressable & monitoring system

## Addressable and monitoring system

### Installation and configuration

Setting of an ID on each luminaire with infrared configuration tool



### Installation checking

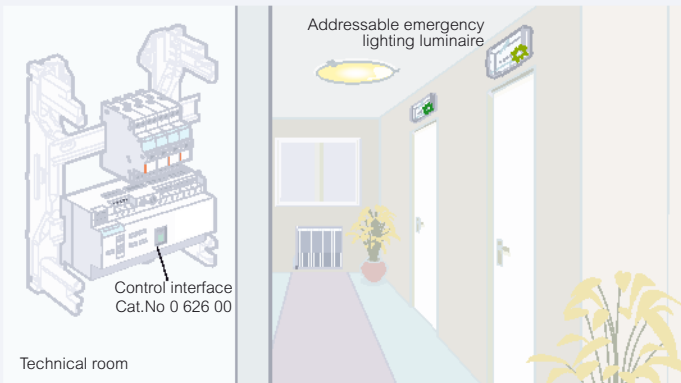

## Monitoring

Centralization operating state

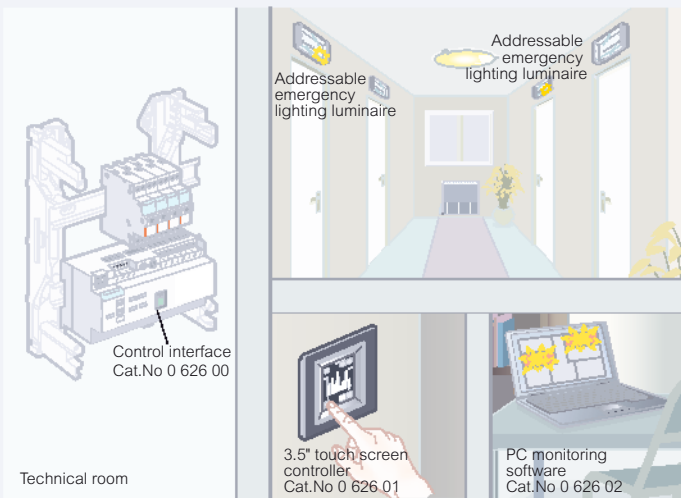

## Control interface dimensions (in mm)

Cat.No 0 626 00

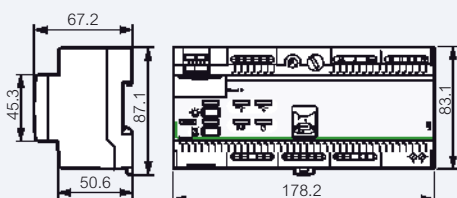

## Wiring

Control interface  
Cat.No 0 626 00

Line: 700 m max.

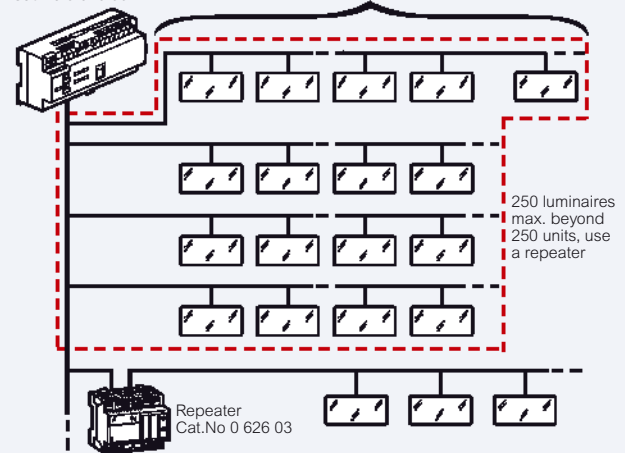

Control interface capacity: 1023 luminaires

## PC connection to control interface(s) through RS 485 serial BUS

Control interface  
Cat.No 0 626 00

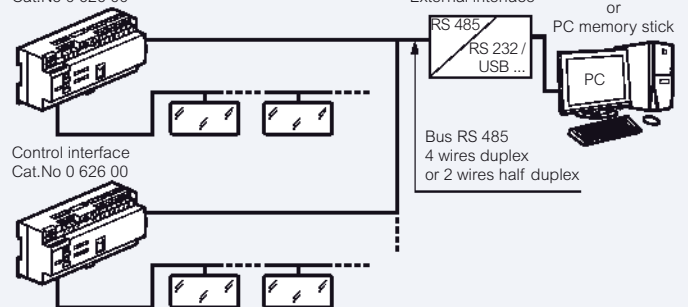

## PC connection to control interface through RS 232 serial line

Control interface  
Cat.No 0 626 00



## PC connection to control interface through Ethernet network

Control interface  
Cat.No 0 626 00

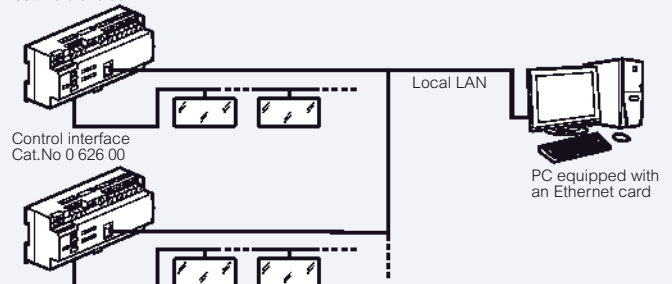

## Power packs

to convert normal lighting source into emergency lighting



0 618 40



0 618 46

To convert one fluorescent normal lighting source into an emergency lighting source  
 Able to operate either on maintained or non-maintained mode  
 Made up with a slim charger/inverter module and a battery pack designed to fit fluorescent luminaires  
 Certified to EN 61347-2-7 standard (☑ Cat.Nos 0 618 40/42/46/48, ☐ other Cat.Nos)  
 Operating ambient temperature: 10 °C to 40 °C  
 Suitable for incorporation into luminaires with internal temperature up to 50 °C  
 To be installed apart in a remote box above 50 °C  
 Ni-Cd batteries  
 Recharge time: 24 h  
 Charge monitor with a green LED

Pack	Cat.Nos	Standard conversion kits
		<b>1 h duration - 230 V - 50/60 Hz - For all lamps</b>
1	0 618 40	For 6 to 36 W lamps
1	0 618 42	For 6 to 58 W lamps (high efficiency)
1	0 618 46	For 6 to 58 W lamps

## Power packs

to convert normal lighting source into emergency lighting

### Dimensions

Cat.Nos 0 618 40/42/46

Module

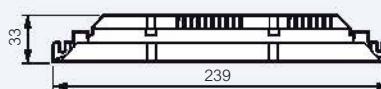

Battery

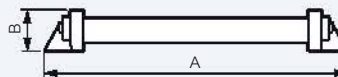

Cat.Nos	A	B	C	D
0 618 40	242	36	36	-
0 618 42	227	36	-	72
0 618 46	227	36	36	-

### Ballast lumen (BLF) selection chart

Lamp	Wattage	BLF (Ballast Lumen Factor)		
		0 618 40	0 618 42	0 618 46
	18 W	0.35	0.95	0.45
	36 W	0.16	0.41	0.18
	58 W	-	0.33	0.15
	14 W	0.29	0.65	0.48
	21 W	0.25	0.56	0.26
	24 W	0.24	0.53	0.24
	28 W	0.22	0.50	0.22
	35 W			
	49 W		0.39	0.18
	54 W		0.38	0.17
	10 W			
	13 W			
	18 W			
	26 W			
	18 W	0.35	0.92	0.44
	24 W	0.21	0.53 <sup>(2)</sup>	0.23 <sup>(2)</sup>
	36 W	0.18	0.43 <sup>(2)</sup>	0.20 <sup>(1)</sup>
	40 W	0.18 <sup>(3)</sup>	0.49	0.22
	55 W	0.13 <sup>(3)</sup>	0.36	0.16
	18 W			
	26 W			
	32 W			
	42 W			
	10 W		0.40 <sup>(1)</sup>	0.88
	16 W	0.48 <sup>(1)</sup>	0.90 <sup>(2)</sup>	0.42 <sup>(2)</sup>
	21 W	0.40	0.76 <sup>(2)</sup>	0.33 <sup>(2)</sup>
	28 W	0.31	0.61 <sup>(2)</sup>	0.28 <sup>(2)</sup>
	38 W	0.26	0.57	0.20
	55 W	-	-	-
	22 W	0.35	0.76	0.35
	32 W	0.24	0.53	0.24
	40 W	0.19	0.42 <sup>(1)</sup>	0.19 <sup>(2)</sup>

1: Autonomy > to 1h30  
 2: Autonomy > to 1h45  
 3: Autonomy > to 45 min



## Access control stand-alone indoor and outdoor kits



0 767 33



0 767 34

Pack	Cat.Nos	Kits
1	0 767 33	<b>Indoor kit</b> Kit comprising: - 1 Mosaic internal coded keypad Cat.No 0 767 41 - 1 Mosaic pushbutton Cat.No 0 770 40 supplied complete - 1 protected power supply Cat.No 0 767 18 and battery Cat.No 0 407 49
1	0 767 34	<b>Outdoor kit</b> Kit comprising: - 1 Soliroc external coded keypad Cat.No 0 778 78 - 1 Mosaic pushbutton Cat.No 0 770 40 supplied complete - 1 protected power supply Cat.No 0 767 18 and battery Cat.No 0 407 49

## Access control stand-alone indoor and outdoor kits

### Installation principle

Indoor kit, Cat.No 0 767 33

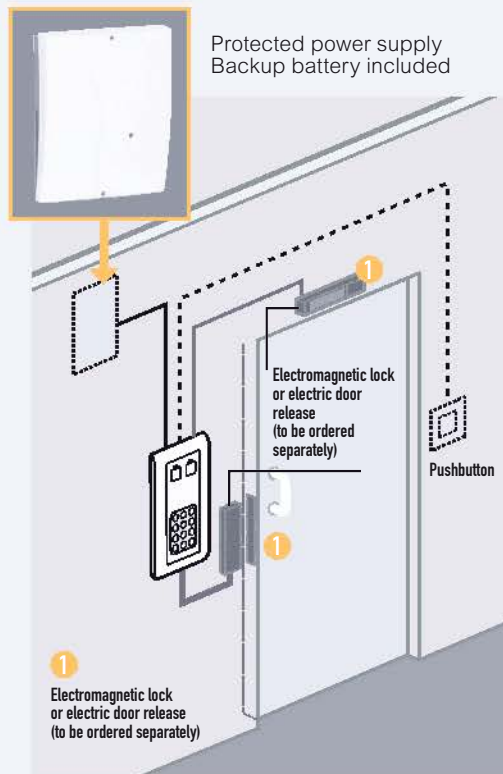

Outdoor kit, Cat.No 0 767 34

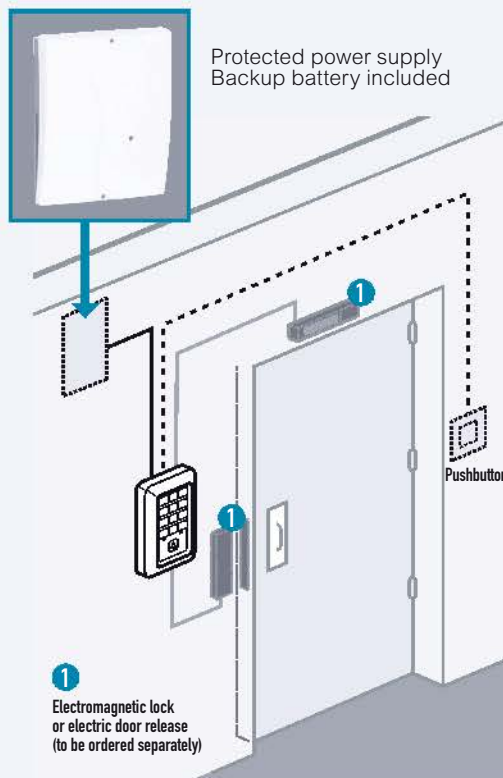

## Access control stand-alone keypads



## Access control stand-alone badge readers



All readers have indicators and a buzzer to indicate the door status

Pack	Cat.Nos	Internal coded keypads
		For mounting in flush or surface-mounting boxes (5 modules) Can be used in stand-alone or centralised mode 100 user codes in stand-alone mode 1 pushbutton input for internal unlocking 1 relay output for door release or electromagnetic lock 10000 codes in centralised mode with door controller Cat.No 0 767 04 (Compatible with Wiegand protocol) Consumption 100 mA - 12 V <sub>DC</sub> IP 40 - IK 04
1	0 767 41	<b>Mosaic</b> Internal coded keypad To be equipped with supports and finishing plates (p. 804)
1	5 722 52	<b>Arteor</b> White internal coded keypad Supplied with support and finishing plate
1	5 727 52	Black Mirror internal coded keypad Supplied with support and finishing plate
		<b>External coded keypads</b>
1	0 778 76	<b>Soliroc</b> External coded keypad Backlit buttons Surface-mounting 100 user codes in stand-alone mode 1 self-protection contact (pull out + opening) 1 pushbutton input for internal unlocking 1 relay output for door release or electromagnetic lock Power supply 12/24 V <sub>AC</sub> /= Consumption 80 mA at 12 V <sub>DC</sub> IP 55 - IK 10
1	0 778 78	External coded keypad with call button Backlit buttons Surface-mounting, cable outlet 100 user codes in stand-alone mode 1 self-protection contact (pull out + opening) 1 pushbutton input for internal unlocking 1 relay output for door release or electromagnetic lock 1 N/O pushbutton on front Power supply 12/24 V <sub>AC</sub> /= Consumption 80 mA at 12 V <sub>DC</sub> IP 55 - IK 10

All readers have indicators and a buzzer to indicate the door status

Pack	Cat.Nos	Internal badge readers
		For mounting in flush or surface-mounting boxes (5 modules) Can be used in stand-alone or centralised mode 500 user badges in stand-alone mode 1 pushbutton input for internal unlocking 1 relay output for door release or electromagnetic lock 10000 badges in centralised mode with door controller Cat.No 0 767 04 (Compatible with Wiegand protocol) Consumption 118 mA - 12 V <sub>DC</sub> - IP 40 - IK 04
1	0 767 42	<b>Mosaic</b> Internal badge reader To be equipped with supports and finishing plates (p. 804)
1	5 722 51	<b>Arteor</b> White internal badge reader Supplied with support and finishing plate
1	5 727 51	Black Mirror internal badge reader Supplied with support and finishing plate
		<b>External badge readers</b>
1	0 778 72	<b>Soliroc</b> Surface-mounting external badge reader Backlit detection area Surface-mounting, cable outlet 500 user badges in stand-alone mode 1 self-protection contact (pull out + opening) 1 pushbutton input for internal unlocking. 1 relay output for door release or electromagnetic lock. Power supply 12/24 V <sub>AC</sub> /= Consumption 80 mA - 12 V <sub>DC</sub> - IP 55 - IK 10



## Access control stand-alone biometric readers, energy saver units and badges



All readers have indicators and a buzzer to indicate the door status

Pack	Cat.Nos	Biometric readers
1	0 767 03	<p>For mounting in flush or surface-mounting boxes (5 modules) Can be used in stand-alone or centralised mode 999 user fingerprints in stand-alone mode 1 pushbutton input for internal unlocking 1 relay output for door release or electromagnetic lock 999 fingerprints in centralised mode with door controller Cat.No 0 767 04 (Compatible with Wiegand protocol) Consumption 145 mA - 12 V IP 40 - IK 04</p> <p><b>Mosaic</b> Biometric fingerprint reader To be equipped with supports and finishing plates (p. 804)</p> <p><b>Arteor</b> White biometric fingerprint reader Supplied with support and finishing plate Black Mirror biometric fingerprint reader Supplied with support and finishing plate</p> <p><b>Vein pattern biometric reader</b> Surface-mounting (protection kit on request) Operates in stand-alone mode with the door opening device connected directly to the reader, or in centralised mode, connected to door controller, Cat.No 0 767 04 1000 vein patterns stored, in both stand-alone and centralised mode Reads vein pattern only, or badge associated with a vein pattern 1 self-protection contact (pull out + opening) Power supply 12 V= Consumption 300 mA IP 43 - IK 04</p>

Pack	Cat.Nos	Energy saver units
1	0 767 28	<p>For switching on a circuit, for example in a meeting room, office, hotel rooms, etc. Only operate with Mifare ISO contactless badges Cat.Nos 0 767 11/12/13 30 s time delay after removal of the badge Low capacity contact: 230 V power 0.25 A Luminous strip on the front so you can see it when you enter the room</p> <p>Mosaic</p>
1	5 722 53	Arteor white
1	5 727 53	Arteor magnesium

Pack	Cat.Nos	Badges
5	0 767 10	<p>MIFARE contactless badge key fob 13.56 MHz With customisable tab included</p>
10	0 767 11	<p>MIFARE contactless badge card ISO format (50 x 80 mm) Chip: 13.56 MHz Standard 1 KB memory</p>
Closing accessories		
1	0 767 07	<p>Electromagnetic lock 300 kg Indicates the position of the door by 2-colour LED and forwarding possible by changeover contact Control of the door position by Hall effect Consumption: 24 V - 300 mA - 7.2 W, 12 V - 600 mA - 7.2 W</p>
1	0 408 95	<p>Undervoltage door release 12 V= - 600 mA For operation in emergency exits</p>
1	0 408 98	<p>Shunt trip door release 12 V= 6 W - 500 mA Dimensions: 158 x 26 x 32 mm</p>
Protected power supply		
1	0 767 18	<p>12 V= - 4 A power supply Backed up by 12 V - 7 Ah battery Cat.No 0 407 49 (not supplied)</p>

## Access control stand-alone

### Installation principle in stand-alone mode

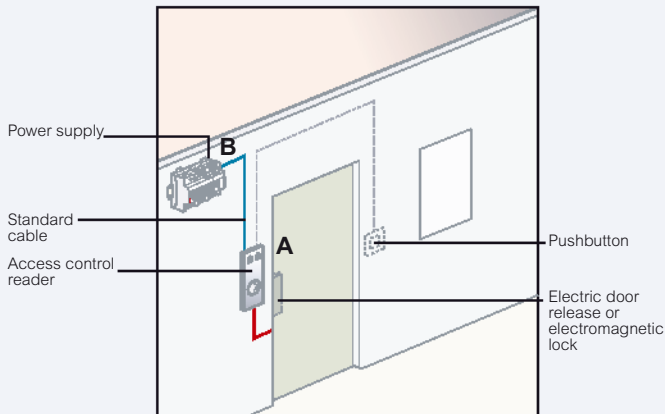

### Wiring principle

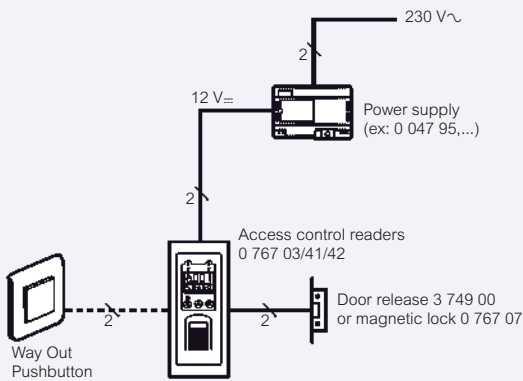

### Selection guide

		Risk level	Door opening to:	
			Inside	Outside
A	Readers	Coded keypad	0 767 00/41 5 722 52/5 727 52	0 778 76/78
		Badge reader	0 767 42 5 722 51/5 727 51	0 778 72
		Fingerprint reader	0 767 03 5 722 50/5 727 50	tailor made 0 767 30
Closing accessories	Door release (flush mounting)	0 408 95/96/98		
	Lock (surface-mounting)	0 767 07/08/09		
B	Power supply	4 131 05 <sup>(1)</sup> 0 047 92 <sup>(1)</sup>	0 767 18 + 0 407 49 <sup>(1)</sup>	

1: The choice of the type of power supply, with or without battery, determines whether the door will open when there is a mains failure

## Access control centralised

### Installation principle in centralised mode

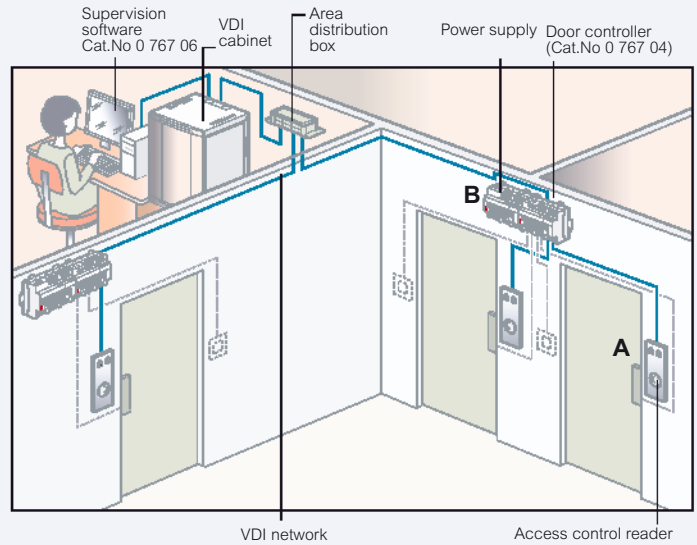

### Wiring principle

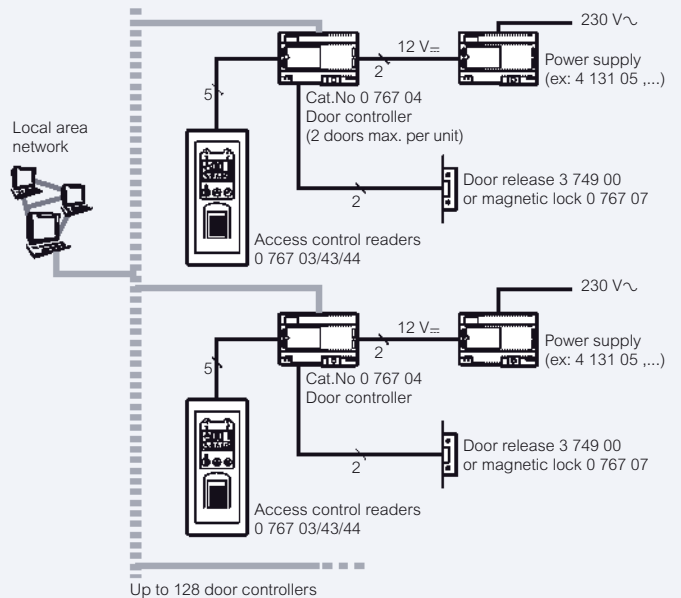

### Selection guide







		Risk level	Door opening to:	
			Inside	Outside
A	Readers	Coded keypad	0 767 43 5 722 52/5 757 52	0 767 17 0 778 73
		Badge reader	0 767 44 5 722 51/5 727 51	0 767 16/32
		Fingerprint reader	0 767 03 5 722 50/5 727 50	tailor made 0 767 30/31
Closing accessories	Door release (flush mounting)	0 408 95/96/98		
	Lock (surface-mounting)	0 767 07/08/09		
B	Power supply	4 131 05 <sup>(1)</sup> 0 047 92 <sup>(1)</sup>	0 767 18 + 0 407 49 <sup>(1)</sup>	

1: The choice of the type of power supply, with or without battery, determines whether the door will open when there is a mains failure

## Access control centralised keypads



All readers have indicators and a buzzer to indicate the door status

Pack	Cat.Nos	Internal coded keypads	Pack	Cat.Nos	External coded keypad
		For mounting in flush or surface-mounting boxes (5 modules) 10,000 codes in centralised mode with door controller Cat.No 0 767 04 (Compatible with Wiegand protocol) Consumption 100 mA - 12 V= IP 40 - IK 04			
1	0 767 00	<b>Centralised internal black coded keypad for door frame</b>  Surface-mounting, slim 10,000 codes in centralised mode with door controller Cat.No 0 767 04 (Compatible with Wiegand protocol) Supplied with dedicated 12 V power supply (enabling operation in stand-alone mode if required) Consumption 100 mA - 12 V IP 54 - IK 07	1	0 767 17	 Backlit buttons Surface-mounting, cable outlet 10,000 codes in centralised mode with door controller Cat.No 0 767 04 (Compatible with Wiegand protocol) 1 self-protection contact (pull out + opening) Power supply 12 V Consumption 80 mA at 12 V= IP 65 - IK 10
1	0 767 43	<b>Mosaic</b>  Internal coded keypad To be equipped with supports and finishing plates (p. 804)	1	0 778 70	<b>Soliroc external coded keypad</b>  Backlit buttons Surface-mounting, cable outlet 10,000 users in centralised mode with door controller Cat.No 0 767 04 (Compatible with Wiegand protocol) Reads code only 1 self-protection contact (pull out + opening) Power supply 12/24 VA/ = Consumption 80 mA at 12 V= IP 55 - IK 10
1	5 722 54	<b>Arteor</b>  White internal coded keypad Supplied with support and finishing plate	1	0 778 73	<b>Coded keypad + badge reader</b>  Soliroc external coded keypad + badge reader Backlit buttons Surface-mounting, cable outlet 10,000 users in centralised mode with door controller Cat.No 0 767 04 (Compatible with Wiegand protocol) Reads code only, badge only, or badge associated with a code 1 self-protection contact (pull out + opening) Power supply 12/24 V~/ = Consumption 80 mA at 12 V= IP 55 - IK 10

## Access control centralised badge readers and biometric readers



0 778 71



0 767 16



0 767 03



Biometric solutions

0 767 30

All readers have indicators and a buzzer to indicate the door status

Pack	Cat.Nos	Internal badge readers	Pack	Cat.Nos	Biometric readers
1	0 767 44	<p>10 000 codes in centralised mode with door controller Cat.No 0 767 04 (compatible with Wiegand protocol) Consumption: 100 mA - 12 V<sub>~</sub> IP 40 - IK 04</p> <p><b>Mosaic</b> Internal badge reader To be equipped with support and finishing plate</p>	1	0 767 03	<p>For mounting in flush-mounting box or surface-mounting (5 modules) Can be used in stand-alone or centralised mode 999 user fingerprints in stand-alone mode 1 pushbutton input for internal unlocking 1 relay output for door release or electromagnetic lock 999 fingerprints in centralised mode with door controller Cat.No 0 767 04 (Compatible with Wiegand protocol) Consumption 145 mA - 12 V IP 40 - IK 04</p> <p><b>Mosaic biometric fingerprint reader</b> To be equipped with supports and finishing plates (p. 804)</p>
1	5 722 55	<p><b>Arteor</b> White internal badge reader Supplied with support and finishing plate</p>	1	5 722 50	<p><b>Arteor white biometric fingerprint reader</b> Supplied with support and finishing plate</p>
1	0 778 71	<p><b>External badge readers</b> <b>Soliroc external badge reader</b> Backlit buttons Surface-mounting, cable outlet 10,000 users in centralised mode with door controller Cat.No 0 767 04 (Compatible with Wiegand protocol) Badge only, or badge associated with a code 1 self-protection contact (pull out + opening) Power supply 12/24 VA/= Consumption 80 mA at 12 V<sub>~</sub> IP 55 - IK 10</p>	1	0 767 30	<p><b>Vein pattern biometric reader</b> Surface-mounting (protection kit on request) Operates in stand-alone mode with the door opening device connected directly to the reader, or in centralised mode, connected to door controller, Cat.No 0 767 04 1000 vein patterns stored, in both stand-alone and centralised mode Reads vein pattern only, or badge associated with a vein pattern 1 self-protection contact (pull out + opening) Power supply 12 V<sub>~</sub> Consumption 300 mA IP 43 - IK 04</p>
1	0 767 16	<p><b>External badge reader</b> Surface-mounting, slim, cable outlet 10,000 user badges in centralised mode with door controller Cat.No 0 767 04 (Compatible with Wiegand protocol) 1 self-protection contact (pull out) Power supply 12 V Consumption 80 mA - 12 V<sub>~</sub> - IP 65 - IK 10</p>	1	0 767 31	<p><b>Biometric fingerprint + badge reader</b> Surface-mounting 10,000 users in centralised mode with door controller Cat.No 0 767 04 (Compatible with Wiegand protocol) Reads fingerprint only (max. 250 fingerprints), or badge associated with a fingerprint 1 self-protection contact (pull out + opening) Power supply 12 V<sub>~</sub> Consumption 300 mA IP 44 - IK 04</p>
1	0 767 32	<p><b>Badge reader for car park</b> Long distance external badge reader Surface mounted, cable outlet 10,000 user badges in centralised mode with door controller Cat.No 0 767 04 (Compatible with Wiegand protocol) Only operates with dual technology badge Cat.No 0 767 12 1 self-protection contact (pull out) Power supply 12 V Consumption 350 mA - 12 V<sub>~</sub> - IP 54 - IK 08</p>			

# Access control centralised controller, accessories and power supplies



Pack	Cat.Nos	Door controller
1	0 767 04	<p><b>DIN rail mounting (6 modules)</b> For centralised management of access control readers from a PC (IP protocol) Up to 2 readers can be connected per controller, and up to 128 controllers per installation (1000 users) Power supply: 12 V<sub>DC</sub> - 175 mA max. 1 x RJ 45 input for connection to VDI network Can control 2 complete door assemblies For more than one controller, use management software Cat.No 0 767 06</p>
1	0 767 06	<p><b>Software</b> LAS (Legrand Access System) management software Required for more than one door controller, for supervision of the following from a PC: - Access (integration of CAD drawings): 256 doors - Readers, badges: 64 user groups - Events (entries, exits): 10000 most recent events - Time periods: 64</p>
1	0 767 05	<p><b>Accessories</b> <b>Badge encoder</b> For easy management of badges (creation, loss, cancellation, theft, etc.) Operates either with stand-alone badge readers, with software which is included, or together with the management software Cat.No 0 767 06 for encoding badges (eg: receptionist, etc.) Connects directly to a PC via USB connection LAS Badge Manager software included for managing stand-alone readers</p>
5	0 767 10	<p><b>Badges</b> <b>MIFARE contactless badge key fob</b> 13.56 MHz With customisable tab included</p>
10	0 767 11	<p><b>MIFARE contactless badge card</b> ISO format (50 x 80 mm) Chip: 13.56 MHz Standard 1 KB memory</p>
10	0 767 12	<p><b>MIFARE contactless dual technology badge card</b> ISO format (50 x 80 mm) Chip: 125 KHz Required for operating an installation with car park reader (customized) Cat.No 0 767 32</p>
10	0 767 13	<p><b>MIFARE contactless badge card with extended memory</b> ISO format (50 x 80 mm) Chip: 13.56 MHz 4 KB extended memory</p>

Pack	Cat.Nos	Closing accessories										
1	0 767 08	<p><b>Electromagnetic lock</b> 500 kg Indicates the position of the door by 2-colour LED and forwarding possible by changeover contact Control of the door position by Hall effect Consumption: 24 V - 250 mA - 7.2 W, 12 V - 500 mA - 7.2 W</p>										
1	0 767 09	<p><b>Motorised bolt</b> With manual internal unlocking Built-in position contact 12 V<sub>DC</sub> - 470 mA For surface-mounting installation</p>										
1	0 408 96	<p><b>2-stage door release</b> Very short shunt-trip door release (2-stage) 12 V<sub>DC</sub> - 200 mA For operation in double-entrance security doors Dimensions: 158 x 26 x 32 mm</p>										
1	0 047 92	<p><b>Power supplies</b> <b>Stabilised 12 V power supply</b> Equipped with: - Electronic protection (against overloads and short-circuits) - Integral fuse protection on input - A green voltage present indicator on output Power supply 115 - 230 V<sub>AC</sub> 12 V<sub>DC</sub></p> <table border="1"> <thead> <tr> <th>Power (W)</th> <th>Current (A)</th> <th>Number of 17.5 mm</th> </tr> </thead> <tbody> <tr> <td>30</td> <td>2.5</td> <td>6</td> </tr> </tbody> </table>	Power (W)	Current (A)	Number of 17.5 mm	30	2.5	6				
Power (W)	Current (A)	Number of 17.5 mm										
30	2.5	6										
1	4 131 05	<p><b>Filtered rectified power supply</b> Comprising: - A safety transformer with interference filtering - A filter capacitor - Protection by PTC integrated in the primary - Double operating terminals PTC: Positive temperature coefficient. In the event of an automatic cut-off due to an overload or short circuit, switches off the power supply and allows it to cool down before switching on again 12 V<sub>DC</sub></p> <table border="1"> <thead> <tr> <th>Power (W)</th> <th>Current (A)</th> <th>Terminal capacity flexible cables (mm<sup>2</sup>) input</th> <th>Terminal capacity flexible cables (mm<sup>2</sup>) output</th> <th>No. of modules</th> </tr> </thead> <tbody> <tr> <td>15</td> <td>1.3</td> <td>6</td> <td>6</td> <td>5</td> </tr> </tbody> </table>	Power (W)	Current (A)	Terminal capacity flexible cables (mm <sup>2</sup> ) input	Terminal capacity flexible cables (mm <sup>2</sup> ) output	No. of modules	15	1.3	6	6	5
Power (W)	Current (A)	Terminal capacity flexible cables (mm <sup>2</sup> ) input	Terminal capacity flexible cables (mm <sup>2</sup> ) output	No. of modules								
15	1.3	6	6	5								
1	0 767 18	<p><b>Protected power supply</b> 12 V<sub>DC</sub> - 4 A power supply Backed up by 12 V - 7 AH battery Cat.No 0 407 49 (not supplied)</p>										

see e-catalogue for detailed information





# Discover our solutions

Ideal solution to manage access control, intruder and technical alarm and CCTV for small to medium commercial premises and offices.

■ **The Smart Security system can manage up to:**

- 20 cameras\*
- 60 access control readers\*
- 40 area boxes
- 160 intruder alarm sensors\*

■ **Capacity: 160 video recordings, more than 1000 events**



Intermediate area box



Terminal area box

■ **The control panel**

At the heart of the system, the control panel holds 2 RJ 45 sockets:

- one dedicated to an intermediate area box in which devices or terminal area boxes can be plugged, hence allowing the connection of many devices.
- one used to connect the Smart Security system to the network or LAN.

Possibility to manage the Smart Security system from a computer or directly through the control panel with a touch screen



Control panel 19"



Touch screen control



0 433 02



0 433 01

Central units able to manage primary and terminal area boxes equipped with either access control, intruder alarm, technical alarm and cameras equipment for small and medium businesses

They are equipped with tamper protection, 2 USB slots, internal GSM transmitter (SIM not supplied)

The central units have embedded webservice software which can be accessible through browsers (mozilla Firefox) on computers, tablets or smartphones

Central units can be managed both locally and remotely through 2 RJ 45 on board

Access control key functions:

- Users / Groups management
- Events / Time schedule management
- Doors equipped with keypad or badge readers

Intruder / Technical alarm key functions:

- Detectors / Zone management / Mode management
- Events / Time schedule management

CCTV key functions:

- IP cameras / live viewing
- Recordings manually and automatically

Common functions:

- Notification email / SMS
- Log export
- System auto surveillance

Pack	Cat.Nos	19" central unit
1	0 433 02	Delivered with all accessories for rack mounting Powered by PoE delivered by a primary area box IP 30- IK 04 1 U - depth 250 mm
1	0 433 01	<b>Touch screen control</b> Wall-mounting or table-mounting (accessories included) Powered by PoE delivered by a primary area box IP 31 - IK 04 322 x 242 x 44 mm

\* Please refer to manuals

# Smart Security system area boxes

## devices capacity



Cat.No	0 433 14	0 433 17	0 433 18	0 433 11	0 433 13	0 433 15	0 433 16
Type	C	AIC	IC	I	T	AI	A
IP IK			= IP 40	= IP 42			IK 06
	PoE 802.3 at 25 W max.						
		: 13.8 V 400 mA max.				: 13.8 V 400 mA max.	: 13.8 V 522 mA max.
			: 13.8 V 2 x 400 mA max.				
		: 13.8 V 640 mA max. : 48 V max. ~ 62.5 VA = 60 W				: 13.8 V 640 mA max.	: 13.8 V 522 mA max. : 48 V max. ~ 62.5 VA = 60 W
					: 13.8 V 400 mA max. : 48 V max. ~ 62.5 VA = 60 W		
				: 13.8 V 640 mA max. : 48 V max. ~ 62.5 VA = 60 W			

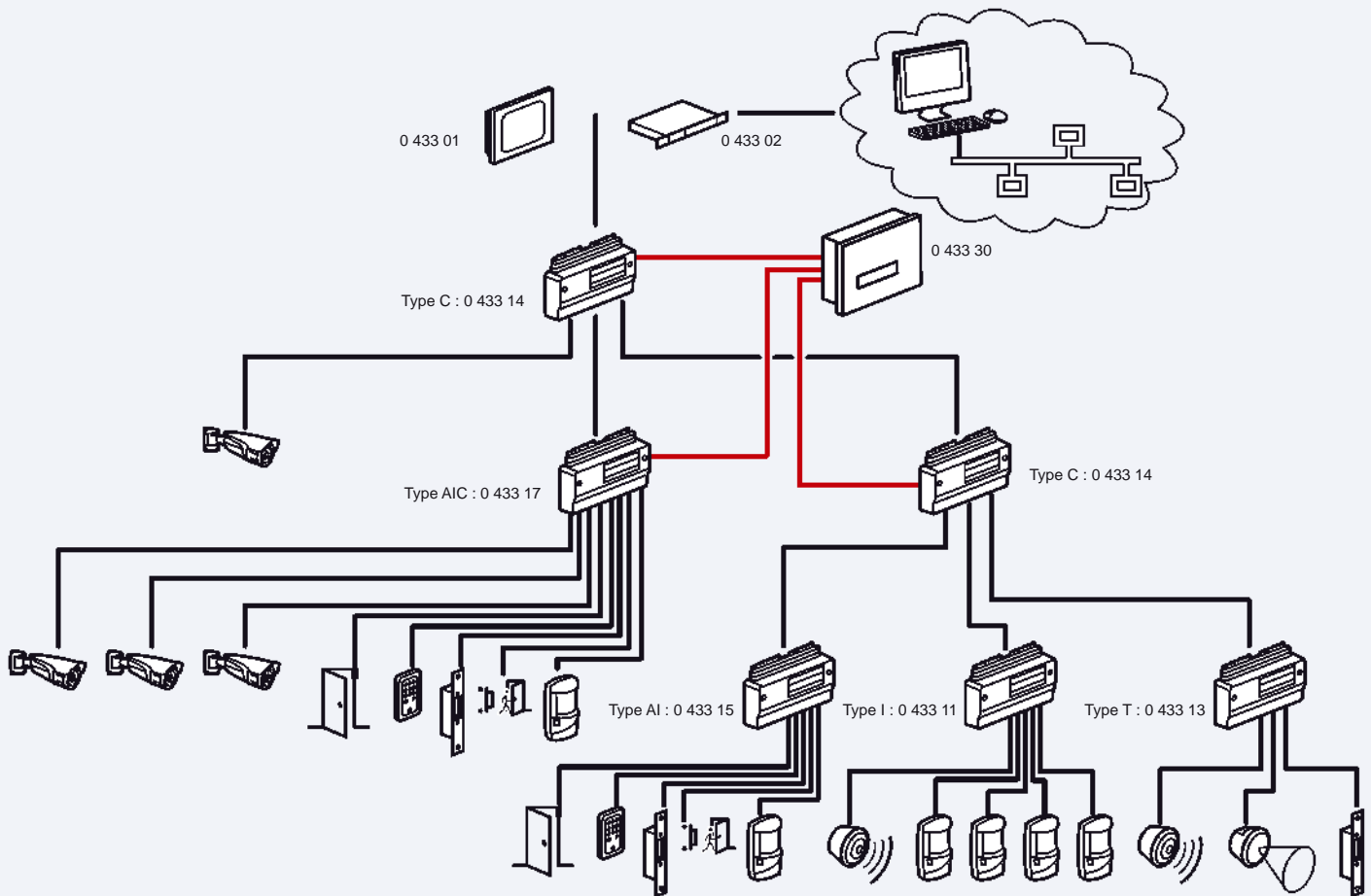

Technical characteristics,  
see e-catalogue



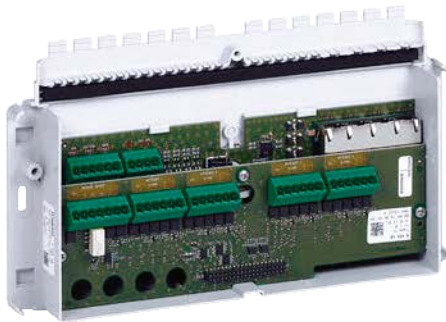

0 433 18

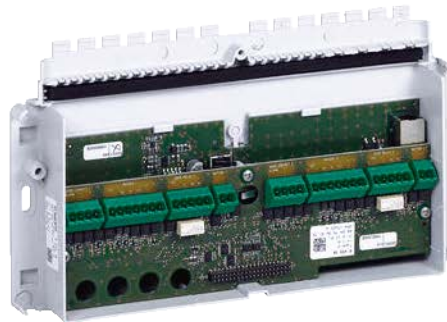

0 433 16

Primary area boxes are plugged together in order to establish the dedicated IP network for Smart Security system  
 From these primary area boxes you can connect primary or terminal area boxes, IP cameras, and one central unit  
 Each area box is also able to connect different devices such as access control readers, intruder sensors, technical sensors or IP cameras  
 Installation: on wall, on cable trays (Cablofil wire mesh trays, perforated metal cable trays) or on DIN rails (accessories supplied)  
 Equipped with 2 LEDs for status, and tamper protection to detect opening and stripping  
 IP 42 - IK 06  
 Dim.: 290 x 162 x 60 mm

Pack	Cat.Nos	Primary area boxes	Pack	Cat.Nos	Terminal area boxes
1	0 433 14	Equipped with 4 RJ 45 plugs (4 x 25 W PoE) Possibility to connect up to 3 cameras per box or 3 terminal area boxes	1	0 433 11	Each terminal box is connected to one primary area box 4 intruder sensor line terminal area box
1	0 433 17	1 input for regulated power supply (Cat.No 0 433 30) 1 access control and 1 intruder sensor line primary area box	1	0 433 12	Possibility to connect 4 intruder sensor line (4 detection contact inputs, 4 position contact inputs, 4 tamper protection inputs)
		Equipped with 4 RJ 45 plugs (4 x 25 W PoE) Possibility to connect up to 3 cameras per box or 3 terminal area boxes	1	0 433 13	1 warning devices output (Cat.Nos 0 432 60/61/63) 4 x 12 V power supply outputs
		Possibility to connect 1 access control (1 Wiegand reader 26/30/34 bits input, 1 door contact input, 1 power relay output, 1 pushbutton input) Possibility to connect 1 intruder sensor line (1 detection contact input, 1 position contact input, 1 tamper protection input)	1	0 433 15	4 relays terminal area box Possibility to connect 4 automatisms through 4 power relays 1 warning devices output (Cat.Nos 0 432 60/61/63) 4 x 12 V power supply outputs
1	0 433 18	3 x 12 V power supply outputs 1 input for regulated power supply (Cat.No 0 433 30) 4 intruder sensor lines primary area box Equipped with 4 RJ 45 plugs (4 x 25 W PoE) Possibility to connect up to 3 cameras per box or 3 terminal area boxes	1	0 433 16	1 access control and 1 intruder sensor line terminal area box Possibility to connect 1 access control (1 Wiegand reader 26/30/34 bits input, 1 door contact input, 1 power relay output, 1 pushbutton input) Possibility to connect 1 intruder sensor line (1 detection contact input, 1 position contact input, 1 tamper protection input)
		Possibility to connect 4 intruder sensor lines (4 detection contact inputs, 4 position contact inputs, 4 tamper protection inputs) 1 warning devices output (Cat.Nos 0 432 60/61/63) 5 x 12 V power supply outputs 1 input for regulated power supply (Cat.No 0 433 30)			3 x 12 V power supply outputs 2 access control terminal area box Possibility to connect 2 access controls (2 Wiegand reader 26/30/34 bits inputs, 2 door contact inputs, 2 power relay outputs, 2 pushbutton inputs) 3 x 12 V power supply outputs



# Smart Security system sensors and alarms

indoor



Table of consumption **see e-catalogue**

To be plugged into primary or terminal area boxes  
Refer to EN 50131 certification (see manuals)

Pack	Cat.Nos	Indoor intruder alarm sensors	Pack	Cat.Nos	Warning devices
		All sensors equipped with tamper protection have to be wired with 6 x 6/10° wires (Cat.No 0 433 95) Max. loop length: 300 m Installation height: 2.3 m			Certified EN 50131-4 Grade 2
1	0 431 45	<b>Ceiling sensor</b> Infrared ceiling detector 7 meters 360° detection if installed on a 2.3 m ceiling	1	0 432 60	<b>Indoor / Outdoor alarm</b> 113 dB to 1 meter (+/- 2 dB) self-powered Supplied without battery (Cat.No 0 407 47) IP 43 - IK 08 Dim.: 246 x 175 x 76 mm
1	0 431 18	<b>Wall-mounting sensors</b> Detection angle 85° - 11 meters range	1	0 432 63	<b>Outdoor alarm with integrated flash</b> 113 dB to 1 meter (+/- 2 dB) self-powered Supplied without battery (Cat.No 0 407 47) IP 43 - IK 08 Flash time: 5 minutes Dim.: 246 x 175 x 76 mm
1	0 431 17	Detection angle 85° - 18 meters range			
1	0 431 19	Detection angle 9,5° - 25 meters range			
1	0 431 42	<b>Double technology wall-mounting sensors</b> Detection angle 85° - 11 meters range			
1	0 431 43	Detection angle 90° - 15 meters range	1	0 432 61	<b>Indoor alarm</b> 113 dB to 1 meter (+/- 2 dB) non self-powered (12 V) Dim.: 143 x 121 x 62 mm
1	0 433 92	<b>Mounting accessory</b> For wall-mounting sensors			
		<b>Perimetric sensors</b>			
1	0 431 00	<b>Magnetic door open sensors</b> Surface-mounting sensor (1 flexible blade / 1 movable magnet)			
1	0 431 01	Flush-mounting (for non-magnetic doors)			
1	0 431 08	For metal door / entrance gate (supplied with cable and steel sheath)			
1	0 431 10	<b>Glass break and contact mat sensors</b> Glass break sensor Detection range: 1.5 m radius			
1	0 431 12	Ultrasonic detection (glass-cutting detection) Contact mat sensor Dim.: 700 x 400 mm			



# Smart Security system badges and accessories

indoor & outdoor



These products have to be plugged into area boxes

Pack	Cat.Nos	Accessories
1	0 433 30	4 A - 56 V power supply Equipped with: - four battery slots for 4 x 12 V/7 Ah or 4 x 12 V/12 Ah batteries - a tamper protection against forced opening and tear - a battery charge control - a system monitoring the overall condition of the charger
1	0 433 95	6-core alarm cable 6/10 <sup>3</sup> (cores are of different colours) for connecting alarm devices Length: 50 m
1	0 433 16	Junction box Dim.: 75 x 75 x 35 mm
1	0 407 49	12 V - 7 Ah battery for power supply Cat.No 0 433 30
1	0 407 47	12 V - 1.2 Ah battery for warning devices Cat.Nos 0 432 60 and 0 432 63
1	0 407 53	12 V - 12 Ah battery for power supply Cat.No 0 433 30

Pack	Cat.Nos	Badges
5	0 767 10	MIFARE contactless badge key fob 13.56 MHz With customisable tab included
10	0 767 11	MIFARE contactless badge card ISO format (50 x 80 mm) Chip: 13.56 MHz Standard 1 KB memory
1	0 767 12	MIFARE contactless dual technology badge card ISO format (50 x 80 mm) Chip: 125 KHz Required for operating an installation with car park reader (customized) Cat.No 0 767 32
1	0 767 13	MIFARE contactless badge card with extended memory ISO format (50 x 80 mm) Chip: 13.56 MHz 4 KB extended memory

Pack	Cat.Nos	Closing accessories
1	0 767 07	<b>Electromagnetic lock</b> Electromagnetic lock 300 kg Indicates the position of the door by 2-colour LED and forwarding possible by changeover contact Control of the door position by Hall effect Consumption: 24 V - 300 mA - 7.2 W, 12 V - 600 mA - 7.2 W
1	0 767 09	<b>Motorised bolt</b> With manual internal unlocking Built-in position contact 12 V <sub>DC</sub> - 470 mA For surface-mounting installation
1	0 408 96	<b>2-stage door release</b> Very short shunt-trip door release (2-stage) 12 V <sub>DC</sub> - 200 mA For operation in double-entrance security doors Dimensions: 158 x 26 x 32 mm



# Simply protect and secure valuable areas

Ideal solutions for retail shops, supermarkets and warehouses

## ■ A WIDE AND GLOBAL RANGE

- Analog solutions
- IP solutions



CCTV kits, [p. 636](#)



Recording solutions, [p. 641, 645](#)



Dome cameras, [p. 638, 642](#)



Video monitors, [p. 646](#)



Speed dome cameras, [p. 639](#)



Management software, [p. 641](#)

## PRODUCT CONFIGURATOR

<http://cctv.legrand.com/>



## TECHNICAL DOCUMENTS



[www.legrandoc.com](http://www.legrandoc.com)



## Select the most suitable cameras

DISTANCE BETWEEN CAMERA AND SCENE (metres)	NARROW SHOTS (Identification)	NARROW SHOTS (Recognition)	
<b>FIXED LENS</b>			
1.2-1.5	Compact cameras: Cat.Nos 4 305 12/40 Dome cameras: Cat.Nos 4 305 00/01/03/05 Special cameras: Cat.Nos 4 305 35/36/39 IP cameras: Cat.Nos 4 306 32/36/37/40/45	-	
2	Compact cameras: Cat.No 4 305 14 IP cameras: Cat.Nos 4 306 30/38	Dome cameras: Cat.No 4 305 00 IP cameras: Cat.Nos 4 306 32/37	
3	-	Dome cameras: Cat.Nos 4 305 00/01/03/05 Compact cameras: Cat.Nos 4 305 12/40 Special cameras: Cat.Nos 4 305 36/35/39 IP cameras: Cat.Nos 4 306 32/36/37/38/40/45	
5	-	Compact cameras: Cat.No 4 305 14	
6	-	-	
10	-	-	
13	-	-	
20	-	-	
<b>VARIFOCAL LENS</b>			
1.5-3	Compact cameras: Cat.Nos 4 305 11/16/15/42/44 Dome cameras: Cat.Nos 4 305 02/04/06/08/20/07/09 Motorised cameras: Cat.Nos 4 305 21/22/23/24/25 Modular cameras: Cat.No 4 305 34	-	
3-4	Compact cameras: Cat.Nos 4 305 11/16/15/42/44 Dome cameras: Cat.Nos 4 305 02/04/06/08/20/07/09 Motorised cameras: Cat.Nos 4 305 21/22/23/24/25 Modular cameras: Cat.No 4 305 34 IP cameras: Cat.Nos 4 306 35/42/44/51/52	Compact cameras: Cat.Nos 4 305 11/16/15/42/44 Dome cameras: Cat.Nos 4 305 02/04/06/08/20/07/09 Motorised cameras: Cat.Nos 4 305 21/22/23/24/25 Modular cameras: Cat.No 4 305 34	
4-7	Motorised cameras: Cat.Nos 4 305 21/22/23/24/25 Modular cameras: Cat.No 4 305 34 IP cameras: Cat.No 4 306 52	Compact cameras: Cat.Nos 4 305 11/16/15/42/44 Dome cameras: Cat.Nos 4 305 02/04/06/08/20/07/09 Motorised cameras: Cat.Nos 4 305 21/22/23/24/25 Modular cameras: Cat.No 4 305 34 IP cameras: Cat.Nos 4 306 35/42/44/52	
7-15	Motorised cameras: Cat.Nos 4 305 21/22/23/24/25 Modular cameras: Cat.No 4 305 34 IP cameras: Cat.No 4 306 52	Motorised cameras: Cat.Nos 4 305 21/22/23/24/25 Modular cameras: Cat.No 4 305 34 IP cameras: Cat.Nos 4 306 51/52	
15-30	Motorised cameras: Cat.Nos 4 305 21/22/23/24/25 Modular cameras: Cat.No 4 305 34 IP cameras: Cat.No 4 306 52	Motorised cameras: Cat.Nos 4 305 21/22/23/24/25 Modular cameras: Cat.No 4 305 34 IP cameras: Cat.No 4 306 52	
30-60	Motorised cameras: Cat.Nos 4 305 25 IP cameras: Cat.No 4 306 52	Motorised cameras: Cat.Nos 4 305 22/23/24/25 Modular cameras: Cat.No 4 305 34 IP cameras: Cat.No 4 306 52	

N.B.: This chart shows the minimum recommended distances and provides a first selection level based on a simple description of the scene to be shot. Greater distances record larger scenes

WIDE SHOTS (Classification)	WIDE SHOTS (Detection)
	
<b>FIXED LENS</b>	
-	-
-	-
-	-
Dome cameras: Cat.No 4 305 00 IP cameras: 4 306 32/37	-
Dome cameras: Cat.Nos 4 305 00/01/03/05 Compact cameras: Cat.Nos 4 305 12/40 Special cameras: Cat.Nos 4 305 36/35/39 IP cameras: Cat.Nos 4 306 32/36/37/40/45	-
Compact cameras: Cat.No 4 305 14 IP cameras: Cat.No 4 306 38	-
-	Dome cameras: Cat.Nos 4 305 00/01/03/05 Compact cameras: Cat.Nos 4 305 12/40 Special cameras: Cat.Nos 4 305 36/35/39 IP cameras: Cat.Nos 4 306 32/36/37/40/45
-	Compact cameras: Cat.No 4 305 14 IP cameras: Cat.No 4 306 38
<b>VARIFOCAL LENS</b>	
-	-
-	-
Compact cameras: Cat.Nos 4 305 11/16/15/42/44 Dome cameras: Cat.Nos 4 305 02/04/06/08/20/07/09 Motorised cameras: Cat.Nos 4 305 21/22/23/24/25 Modular cameras: Cat.No 4 305 34	-
Compact cameras: Cat.Nos 4 305 11/16/15/42/44 Dome cameras: Cat.Nos 4 305 02/04/06/08/20/07/09 Motorised cameras: Cat.Nos 4 305 21/22/23/24/25 Modular cameras: Cat.No 4 305 34 IP cameras: Cat.Nos 4 306 35/42/44/52	-
Motorised cameras: Cat.Nos 4 305 21/22/23/24/25 Modular cameras: Cat.No 4 305 34 IP cameras: Cat.Nos 4 306 51/52	Compact cameras: Cat.Nos 4 305 11/16/15/42/44 Dome cameras: Cat.Nos 4 305 02/04/06/08/20/07/09 Motorised cameras: Cat.Nos 4 305 21/22/23/24/25 Modular cameras: Cat.No 4 305 34 IP cameras: Cat.Nos 4 306 35/42/44/51/52
Motorised cameras: Cat.Nos 4 305 21/22/23/24/25 Modular cameras: Cat.No 4 305 34 IP cameras: Cat.No 4 306 52	Motorised cameras: Cat.Nos 4 305 21/22/23/24/25 Modular cameras: Cat.No 4 305 34 IP cameras: Cat.No 4 306 52

## 7" CCTV kit



## 17" CCTV kit



4 307 50

Effective in small shops thanks to the compact size of the 7" monitor and the DVR

The kit can be expanded with up to 4 cameras

Pack	Cat.Nos	7" CCTV kit
1	4 307 50	CCTV kit consisting of: - 4-input DVR (Cat.No 4 307 53), 7" LCD monitor (Cat.No 4 305 74) - 1 compact outdoor camera with IR capabilities and 3.6 mm fixed lens (Cat.No 4 305 12), stabilised power supply with plastic housing 12 Vdc 2.5 A (Cat.No 4 306 01) - DVR remote control and mouse supplied



4 307 51

Effective in SoHo applications with global solution including a large 17" monitor and DVR

The kit can be expanded with up to 4 cameras

Pack	Cat.Nos	17" CCTV kit
1	4 307 51	CCTV kit consisting of: - 4-input DVR with LAN (Cat.No 4 307 53), 17" LCD monitor (Cat.No 4 305 70) - 1 compact outdoor camera with IR capabilities and 3.6 mm fixed lens (Cat.No 4 305 12), stabilised power supply with plastic housing 12 Vdc 2.5 A (Cat.No 4 306 01) - DVR remote control and mouse supplied



More information in our new CCTV brochure available on [www.docexport.legrand.com](http://www.docexport.legrand.com)



## Example of installation

### ■ CCTV kit expandable up to 4 cameras

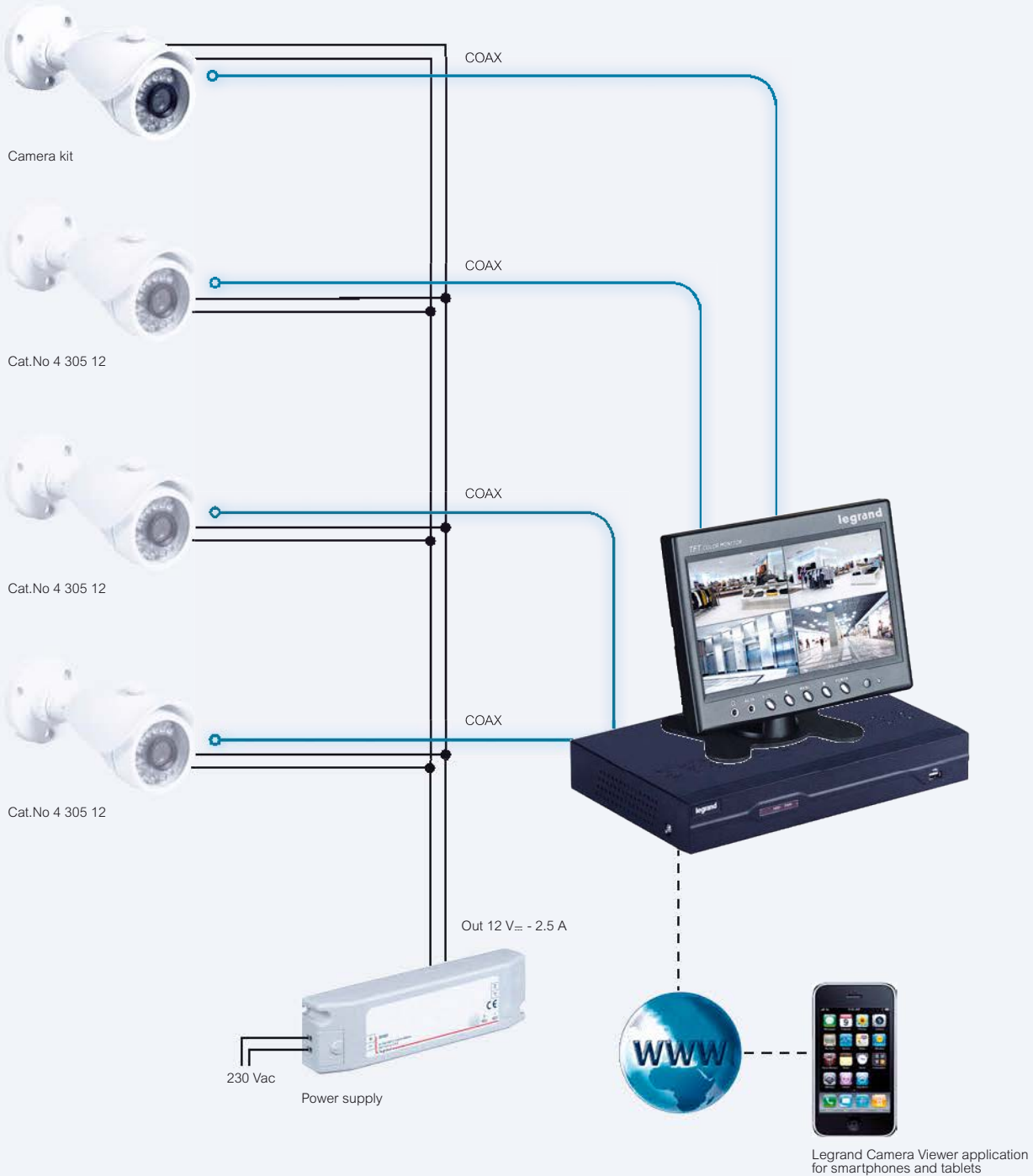

**NOTE:** the power supply cables must be of adequate cross-section in relation to the distance and the corresponding voltage drop

## CCTV analog compact and dome cameras indoor and outdoor



Selection chart p. 634-635

Pack	Cat.Nos	Outdoor compact cameras	Pack	Cat.Nos	Indoor dome cameras
1	4 305 12	<b>Compact fix lenses 3.6 mm</b> Outdoor Night & Day SHARP 1/3", 600 TV lines LED illumination: 20 m White body camera with fixing bracket supplied Max. 210 mA - 12 V <sub>DC</sub> with IR LED ON	1	4 305 00	<b>Dome cameras fix lens</b> Indoor dome, 2.8 mm lens Sony 1/3", 420 TV lines Min. illumination: 0.1 lux White body camera Max. 70 mA - 12 V <sub>DC</sub>
1	4 305 40	Outdoor Day & Night Sony 1/3", 700 TV lines LED illumination: 20 m Grey body camera with fixing bracket supplied Max. 200 mA - 12 V <sub>DC</sub> with IR LED ON	1	4 305 01	Indoor Day & Night dome, 3.6 mm lens Sharp 1/3", 540 TV lines Min. illumination: 0.08 lux White body camera Max. 70 mA - 12 V <sub>DC</sub>
1	4 305 14	<b>Compact lens 6 mm</b> Outdoor Day & Night Sony 1/3", 420 TV lines LED illumination: 25 m Grey body camera Max. 420 mA - 12 V <sub>DC</sub> with IR LED ON	1	4 305 02	<b>Dome varifocal lens</b> Indoor dome, 2.8-12 mm Sony 1/3", 700 TV lines Min. illumination: 0.01 lux White body camera Max. 150 mA - 12 V <sub>DC</sub>
1	4 305 42	<b>Compact varifocal lenses 2.8-12 mm</b> Outdoor Day & Night with ICR Light black body camera with fixing bracket supplied Max. 160-480 mA - 12 V <sub>DC</sub> with IR LED ON	1	4 305 06	Indoor WDR Day & Night with ICR 2.8-12 mm Sony 1/3" sensor, resolution 700 TV lines Min. illumination: 0.03 lux White body camera Max. 210 mA - 12 V <sub>DC</sub>
1	4 305 44	Sony 1/3", 700 TV lines, IR 35m			
1	4 305 15	<b>Compact varifocal lens 9-22 mm</b> Outdoor Day & Night with ICR Sony 1/3" Led illumination: 50 m Light black body camera with fixing bracket supplied Max. 470 mA - 12 V <sub>DC</sub> with IR LED ON			
1	4 305 41	600 TV lines	1	4 305 05	<b>Outdoor dome cameras</b> <b>Dome fix lens</b> Outdoor Day & Night, 3.6 mm lens Sony 1/3" sensor, resolution 600 TV lines LED illumination: 35 m White body camera Max. 336 mA - 12 V <sub>DC</sub> with IR LED ON
1	4 305 43	700 TV lines	1	4 305 07	<b>Dome varifocal 2.8-12 mm</b> Outdoor dome Sony 1/3" CCD, 600 TV lines LED illumination: 25 m White body camera Max. 310 mA - 12 V <sub>DC</sub> with IR LED ON
1	4 305 17	<b>Compact varifocal lens 10-65 mm</b> Outdoor Day & Night Sony 1/3", 540 TV lines LED illumination 100 m Grey body camera with fixing bracket supplied Max. 78 mA - 230 Vac with IR LED ON	1	4 305 20	<b>Dome varifocal 2.8-12 mm</b> Outdoor Day & Night with ICR, Min. illumination: 0 lux with IR LED ON White body camera Max. 320 mA - 12 V <sub>DC</sub> with IR LED ON
			1	4 305 04	CMOS 1/3", 600 TV lines, IR 25 m
			1	4 305 08	Sony 1/3" 700TVL IR 25 m
			1	4 305 09	Sony HAD 1/3" 700TVL IR 25 m WDR Vandal Proof
			1	4 305 09	Sony 1/3" 700TVL IR 35 m



# CCTV analog speed dome motorised cameras and accessories

indoor and outdoor



4 305 21



4 305 23



4 305 24



4 306 03

Selection chart p. 634-635

Pack	Cat.Nos	Speed dome motorised cameras - 12 V <sub>~</sub>
		<p>Auto-IRIS, auto-FOCUS, BLC, AGC S/N ratio = 50 dB (AGC OFF) Motorised cameras on 3 axes: horizontal, vertical and zoom for surveillance of the area Must be combined with the 3-axis keypad Cat.No 4 306 03 Can also be controlled through the DVRs (p. 641)</p> <p><b>Indoor cameras</b> Super HAD 1/4" CCD sensor Sensitivity of 0.4 lux (colour) - 0.02 lux (B/W) Horizontal resolution of 550 TV lines (colour) Effective pixels 752 (H) x 582 (V) Pelco-D/Pelco-P protocols 127 programmable presets 1 A (power supply not supplied)</p>
1	4 305 21	12 x (f = 3.6 - 44.3 mm) optical zoom 500 TVL 4 privacy masking zones
1	4 305 22	27 x (f = 3.5 - 94.5 mm) optical zoom 8 privacy masking zones
		<p><b>Outdoor cameras</b> SAMSUNG 1/4" sensor Effective pixels 752 (H) x 582 (V) 2.5 A (power supply not supplied) Standard wall bracket supplied with the camera</p>
1	4 305 23	12 x (F1.8, f = 3.6 - 44.3 mm) optical zoom Sensitivity of 0.7 lux (colour) - 0.02 lux (B/W) Horizontal resolution of 500 TV lines (colour) Zoom speed of 1.75 sec. (from Wide to Tele) 4 privacy masking zones
1	4 305 24	27 x (f = 3.5 - 94.5 mm) optical zoom Sensitivity of 0.7 lux (colour) - 0.6 lux (B/W) Horizontal resolution of 550 TV lines (colour) Zoom speed of 2.5 sec (from Wide to Tele) 8 privacy masking zones
1	4 305 25	37 x (f = 3.5 - 129.5 mm) optical zoom Sensitivity of 0.4 lux (colour) - 0.02 lux (B/W) Horizontal resolution of 550 TV lines (colour) Zoom speed of 1.8 sec. (from Wide to Tele) 8 privacy masking zones

Pack	Cat.Nos	Accessories for speed dome motorised cameras
		<p><b>Mounting accessories</b></p>
1	4 305 94	Wall bracket for indoor speed dome camera Cat.No 4 305 22
1	4 305 97	Ceiling accessory for indoor speed dome camera Cat.No 4 305 22
1	4 305 96	False ceiling bracket for indoor speed dome camera Cat.No 4 305 22
1	4 305 95	Ceiling bracket for outdoor speed dome cameras Cat.No 4 305 23/24/25
1	4 305 98	Angular bracket for speed dome cameras Cat.No 4 305 22/23/24/25
1	4 305 99	Pole strap for outdoor speed dome cameras Cat.No 4 305 23/24/25
		<p><b>Keypad</b></p>
1	4 306 03	Keypad with 3-axis joystick for controlling the speed dome cameras LCD display, multi-protocol remote control (RS485) up to 1000 m, selectable data transmission speed Power supply: 12 V <sub>~</sub> - 140 mA (power supply supplied)

## CCTV analog modular cameras

indoor



4 305 34



4 305 75

Selection chart p. 634-635

Pack	Cat.Nos	Modular indoor cameras
		<b>Standard</b> SHARP 1/3" sensor, 540TVL Day & Night cameras Min. illumination of 0.1 lux For difficult light conditions Wall & ceiling mounting not supplied To be equipped with lenses & housings Grey color
1	4 305 30	Max. 100 mA 12 V=
1	4 305 32	Max. 110-230 Vac
1	4 305 34	<b>High resolution</b> Day & Night camera 36 x (3.4-122.4 mm) optical zoom Sony 1/4" sensor, resolution 550 TV lines ICR filter, 0.05 (day) & 0.008 (night) lux sensitivity Max. 380 mA 12 V=
		<b>Day &amp; Night high sensitivity</b> Night vision for infrared light sensitivity SONY 1/3" sensor, resolution 700 TV lines ICR filter, 0.8 (day) & 0.05 (night) lux sensitivity Wall & ceiling mounting not supplied To be equipped with lenses & housings
1	4 305 31	12 V 90 mA, not supplied
1	4 305 33	110-230 Vac, not supplied
1	4 305 75	WDR Day & Night camera with ICR Sony 1/3" sensor, resolution 700 TV lines Grey body camera, ceiling or wall mounting Max. 300 mA 12 V=

## CCTV analog special cameras and accessories



4 305 36



4 305 88



4 305 87



4 305 92

Selection chart p. 634-635

Pack	Cat.Nos	Special and dummy indoor cameras
1	4 305 35	Day & Night mini camera, 3.6 mm lens SONY 1/3" sensor, 420 TV lines Min. illumination of 0.2 lux Cupboard mounting supplied Max. 120 mA 12V=
1	4 305 39	Day & Night camera with spot light look 3.7 mm conical lens SONY 1/3" sensor, 420 TV lines Min. illumination of 0.05 lux Max. 120 mA 12V=
1	4 305 36	Camera with smoke detector look 3.7 mm conical lens Sony 1/3" sensor, 700 TV lines Min. illumination of 0.01 lux Max. 120 mA 12V=
1	4 305 37	Dummy dome camera, with housing of real camera and with a real lens Shape is identical to Cat.No 4 305 01
1	4 305 38	Dummy compact camera, with housing of real camera and with a real lens Shape is identical to Cat.No 4 305 13
		<b>Infrared LED illuminators</b> Provide night vision for cameras White casing with wall-mounting (supplied) Distance of 50 m. IP66 / IK10 Power supply: 230 VA Can be combined with outdoor camera housing Cat.No 4 305 89
1	4 305 88	
1	4 305 87	Distance of 30 m. IP55 / IK06 Power supply: 12 V=
		<b>Mounting accessories and housings</b>
1	4 305 89	Metal housing for modular cameras Cat.Nos 4 305 30/31/32/33 Tempered housing for outdoor use White housing in metal, open on top, IP 68 / IK10 12 V= power supply integrated - 2.5 A Heating 20 W and air cooling integrated Wall-mounting and accessory included
1	4 305 91	Pole mounting for metal housing Cat.No 4 305 89
1	4 305 92	Wall bracket for indoor or modular camera - 11 cm
1	4 305 93	Wall bracket for indoor or modular camera - 18 cm
		<b>Power supplies</b>
1	4 306 01	Stabilised power supply Input: 230 VA, output: 2.5 A, IP30 / IK05
1	4 306 02	DIN stabilised power supply Input: 230 VA - 50 Hz, output: 4.5 A 4 modules
1	4 306 00	Plug-in power supply: 0.5 A
		<b>Varifocal auto-iris lenses</b>
1	4 305 80	2.8 - 11.5 mm
1	4 305 81	3.5 - 8 mm
1	4 305 82	5 - 50 mm
		<b>CCTV tester</b>
1	4 305 86	Tester

# CCTV analog standard and high resolution DVR, VMS software



Pack	Cat.Nos	Standard DVR	Pack	Cat.Nos	VMS management software
1	4 307 53	<p>H.264 compression format, resolution of 720 x 576 (PAL)                      Motion detector and USB port for connection to the back-up device                      Integrated 500 Gb SATA hard disk (1 Tb for Cat.No 4 307 55)                      Equipped with an RJ 45 for LAN connection                      Full D1 compatible on each video input                      In - out alarm contacts                      Watermarking                      IR remote control supplied                      Allows remote viewing of images on PDA devices with compatible operating systems (iPhone, Android) via the Legrand Camera Viewer application for smartphones and tablets (Data usage is at the user's expenses)                      12 V<sub>DC</sub> (supplied)</p>	1	4 306 21	<p>PC software allowing:</p> <ul style="list-style-type: none"> <li>views from cameras to be centralised:                             <ul style="list-style-type: none"> <li>- IP cameras connected directly to the network or recorded using an NVR</li> <li>- analog cameras connected to a DVR LAN recorder or a video encoder</li> </ul> </li> <li>recordings stored on DVR LAN and NVR recorders to be accessed</li> <li>one or more cameras to be recorded locally via the management PC</li> <li>local or remote recordings to be searched for and exported</li> <li>cameras to be managed in accordance with the plan</li> <li>mobile cameras to be controlled</li> <li>remotely configuring IP cameras, NVRs, DVRs and encoders</li> <li>automatical searching for IP cameras, NVRs, DVRs and encoders connected to the network</li> </ul> <p>Capacity 1000 cameras, 36 maximum simultaneously                      Graphic interface: up to 8 displays                      The use of this software requires all the products (IP cameras, DVR, NVR) to be connected to the Ethernet network                      Minimum configuration:</p> <ul style="list-style-type: none"> <li>operating system: Windows XP, Windows Vista, Windows 7</li> <li>processor: Intel Core i5-760</li> <li>RAM: 4 Gb</li> <li>sound card: standard</li> <li>graphics card: NVIDIA GeForce 9400GT or above</li> <li>network card: 10/100/1000 Ethernet</li> </ul>
1	4 307 54	8-input Digital Video Recorder (DVR), 50 fps @960h			
1	4 307 55	16-input 1TB hard disk size 400 fps @960h			
		<b>High resolution DVR</b>			
		<p>Fully compatible with VMS Management Software                      H.264 compression format                      Real-time display                      DVD-RW and USB ports for back-up on external devices                      Allow remote viewing of images on PDA devices with compatible operating systems (iPhone, Android) via the Legrand Camera Viewer application for smartphones and tablets (Data usage is at the user's expenses)                      19" rack compatibility                      Protocols supported: DHCP, PPPOE, STATIC                      230 Vac - 50 Hz</p>			
1	4 307 57	4-input Digital Video Recorder (DVR) 1 Tb hard disk supplied Video resolution of 100 fps @960h			
1	4 307 58	8-input Digital Video Recorder (DVR) 2 Tb hard disks supplied Video resolution of 200 fps @960h			
1	4 307 59	16-input Digital Video Recorder (DVR) 4 Tb hard disks supplied Video resolution of 400 fps @960h			



4 306 36



4 306 37



4 306 38



4 306 40

Selection chart p. 634-635

Pack	Cat.Nos	Dome cameras	Pack	Cat.Nos	Compact cameras
		Compression format: H264 ONVIF 2 / Profile S compliant			
1	4 306 32	<b>Indoor dome camera 1.3 megapixels (720p) 2.8 mm</b> Day & Night HD camera Sensor: 1/3" CMOS Aptina Main stream: 15 fps @ 1,3 MP or 25 fps @ 720p Secondary stream: 25 fps @ D1 Ceiling or wall mounting, White plastic housing Power supply: PoE (802.3af class 3) or 12 Vcc Power consumption: 1.5 W / 0.125 A			<b>Indoor DWDR 1.3 megapixels (720p) cameras 3.6 mm</b> Day & Night HD camera White LED lighting range 10 metres Sensor: 1/3" CMOS Aptina Main stream: 15 fps @ 1.3MP or 25 fps @ HD 720p Secondary stream: 25 fps @ D1 White plastic housing Power consumption: 4 W / 0.5 A Power supply: PoE (802.3af class 3) or 12 Vcc Wi-Fi
1	4 306 36	<b>Outdoor camera 1.3 megapixels (720p) 2.8 mm</b> Day & Night camera HD with IR 15 metres Sensor: 1/3" CMOS Aptina Main stream: 15 fps @ 1,3 MP or 25 fps @ HD 720p Secondary stream: 25 fps @ D1 Wall mounting, White metal /plastic housing Power supply: PoE (802.3af class 3) or 12 Vcc Power consumption: 6 W / 0.5 A	1	4 306 38 4 306 30	<b>Outdoor camera 1.3 megapixels (720p) 3.6 mm</b> Day & Night HD camera with IR 15 metres Sensor: 1/3" CMOS Aptina Main stream: 15 fps @ 1.3 MP or 25 fps @ HD 720p Secondary stream: 25 fps @ D1 Wall mounting, White metal housing Power supply: PoE (802.3af class 3) or 12 Vcc Power consumption: 6 W / 0.5 A
1	4 306 37	<b>Outdoor DWDR dome camera 2 megapixels (1080p) 2.8 mm</b> Day & Night camera Full HD Sensor: 1/2.8" CMOS Sony Exmor Main stream: 25 fps @ full HD 1080p Secondary stream: 25 fps @ D1 White metal housing Power supply: PoE (802.3af class 3) or 12 Vcc (not supplied) Power consumption: 1.5 W / 125 mA	1	4 306 45	<b>Outdoor camera 2 megapixels (1080p) 3.6 mm</b> Day & Night HD camera with IR 15 metres Sensor: 1/3" CMOS Aptina Main stream: 25 fps @ full HD 1080p Secondary stream: 25 fps @ D1 Wall-mounting, white metal housing Power supply: PoE (802.3af class 3) or 12 Vcc Power consumption: 6 W / 0.5 A
1	4 306 35	<b>Outdoor DWDR dome camera 3 megapixels (1080p) 3.3-12 mm varifocal lens</b> Day & Night camera Full HD with IR 20 metres Sensor: 1/2.8" CMOS Sony Exmor Main stream: 15 fps @ 3MP or 25 fps @ Full HD 1080p Secondary stream: 25 fps @ D1 Power supply: PoE (802.3af class 3) or 12 Vcc/24 Vac Ceiling or wall mounting, White metal housing Power consumption: 10 W	1	4 306 44	<b>Outdoor camera 2 megapixels (1080p) 3.3-12 mm</b> Day & Night HD camera with IR 20 metres Sensor: 1/3" Sony Exmor CMOS Main stream: 25 fps @ HD 1080p or 25 fps @ HD 720p Secondary stream: 25 fps @ D1 Wall-mounting, white metal housing Power supply: PoE (802.3af class 3) or 12 Vcc Power consumption: 10 W / 0.9 A
			1	4 306 42	<b>Outdoor camera 3 megapixels (1080p) 3.3-12 mm</b> Day & Night HD camera with IR 20 metres Sensor: 1/3" Sony Exmor CMOS Main stream: 15 fps @ 3 MP or 25 fps @ HD 1080p Secondary stream: 25 fps @ D1 Wall-mounting, white metal housing Power supply: PoE (802.3af class 3) or 12 Vcc Power consumption: 10 W / 0.9 A

## CCTV IP motorised and modular cameras



4 306 52



4 306 51



4 306 61



4 306 62



Selection chart p. 634-635

Pack	Cat.Nos	Motorised cameras	Pack	Cat.Nos	Modular cameras
1	4 306 52	<p>Compression format: H264 ONVIF 2 / Profile S compliant</p> <p><b>Outdoor WDR speed dome 1.3 megapixels (720p) - 18x optical zoom</b> Day &amp; Night HD speed dome Sensitivity: color: 0.5 Lux/F1.6, B/W: 0.02 Lux/F1.6 Sensor: 1/3" CMOS Aptina Lens: 18x optical zoom (4.7-84.6 mm), 16x digital zoom Main stream: 15 fps @ 1.3 MP or 25 fps @ 720p Secondary stream: 25 fps @ D1 Wall-mounting (bracket supplied) Power supply: 24 VAC (supplied) Power consumption: 15 W / 0.65 A (normal), 50 W / 2.1 A (heating active)</p>	1	4 306 60	<p><b>Indoor DWDR camera 1.3 megapixels (720p)</b> Compression format: H264 ONVIF 2 / Profile S compliant Main stream: 15 fps @ 1.3 MP or 25 fps @ HD 720 p Secondary stream: 25 fps @ D1 Day /Night function Sensitivity: 0.1 lux F1.2 Sensor: 1/2.7" CMOS, 540L (colour) / 600L (black and white), with progressive scanning Compatible lenses: C/CS-mounting Compression format: H264 Power supply: PoE (802.3af class 3) or 12 V= (not supplied) - 5 W Internal memory: micro SD card (not supplied) 1 audio input/1 audio output (bidirectional) 1 event input/1 event output (potential-free NO-NC contact) Ceiling or wall mounting White metal housing</p>
1	4 306 51	<p><b>Outdoor speed dome 2 megapixels (1080p) - 3x optical zoom</b> Day &amp; Night HD speed dome Sensitivity: color: 0.05 Lux/F1.2, B/W: 0.0005 Lux/F1.6 Sensor: 1/2.8" Sony Exmor CMOS Lens: 3x optical zoom (3-9 mm) Main stream: 25 fps @ Full HD 1080p or 25 fps @ HD 720p Secondary stream: 25 fps @ D1 Wall-mounting (bracket supplied) Power supply: 24 VAC (supplied) Power consumption: 15 W / 1.3 A</p>	1	4 306 61	<p><b>Indoor DWDR camera 3 megapixels (1080p)</b> Day &amp; Night Full HD camera with ICR Sensor: 1/2.8" Sony Exmor Compatible lenses: C/CS-mounts / auto iris supported Main stream: 15 fps @ 3 MP or 25 fps @ Full HD 1080p Secondary stream: 25 fps @ D1 Ceiling or wall-mounting White metal housing Power consumption: 5 W</p>
			1	4 306 62	<p><b>Indoor DWDR camera 5 megapixels (1080p)</b> Day &amp; Night Full HD camera Sensor: 1/3" Aptina CMOS Compatible lenses: C/CS-mounts / auto iris supported Main stream: 8 fps @ 5 MP or 25 fps @ Full HD 1080p Secondary stream: 25 fps @ D1 Ceiling or wall-mounting White metal housing Power consumption: 6 W</p>



4 306 91



4 305 84



4 305 85

Pack	Cat.Nos	Outdoor housings for IP cameras - IP 68 - IK 10
1	4 306 92	<p><b>PoE outdoor metal housing - Ivory</b>                      Thermostatically controlled housing for outdoor installation                      Cable ducting built into the housing (cable glands and wall mounting included)                      Opened from the top                      Adjustable internal stand for precise adjustment of the camera's position                      20 W heating                      Hi-PoE power supply (injector supplied) or 12 V<sub>DC</sub> (power consumption 2,500 mA)                      For pole-mounting, add Cat.No 4 306 91                      Operating temperature: - 30 °C to + 60 °C                      Advanced function: 4 outputs 12V<sub>DC</sub> and 1 port RJ 45 PoE available inside</p>
1	4 306 93	<p><b>PoE outdoor metal housing with IR - Ivory</b>                      Thermostatically controlled and ventilated housing for outdoor installation                      Cable ducting built into the housing (cable glands and wall mounting included)                      Infrared lighting using built-in LEDs                      Adjustable LED range: 50 - 70m                      Light sensor for triggering the infrared lighting                      20 W heating, heat dissipated by a built-in fan                      Automatic demisting                      Hi-PoE power supply (injector supplied) or 230 V<sub>AC</sub> (power consumption 5,000 mA)                      Operating temperature: - 30 °C to + 60 °C                      Opened from the top                      For pole-mounting, add Cat.No 4 306 91                      Advanced functions:                      - Infrared lighting automatically triggered by a light sensor                      - NO-NC output contact triggered by the light sensor (to control day/night switching by a camera, for example)                      - 4 outputs 12V<sub>DC</sub> and 1 port RJ 45 PoE available inside                      Pole mounting for outdoor metal housing                      Pole mounting system (diameter 83 - 177 mm)</p>

Pack	Cat.Nos	Mounting accessories
1	4 306 91	Pole mounting accessory for outdoor housing Adjustable size: 83 - 117 mm diameter
1	4 305 78	Corner adaptor for IP speed dome camera
		<b>Lenses for IP modular cameras</b>
		Varifocal lenses for D1 and Megapixel cameras Lens mount ring: CS-mounting DC powered Compatible with infrared lighting
1	4 305 84	<b>1/2.7" 3.3 - 12 mm lens</b> Adjustable between 3.3 and 12 mm
1	4 305 85	<b>1/2" 10 - 40 mm lens</b> Adjustable between 5 and 50 mm

# CCTV IP Network Video Recorders



4 306 73



4 306 20

Pack	Cat.Nos	Network Video Recorders	Pack	Cat.Nos	IP decoder 28 channels D1
		<p>Pentaplex: simultaneous live, record, playback, extraction and remote access                      Front, mouse or remotely operated                      Video compression format: H264                      Recordings viewable on Smartphone or PC                      Compatible with VMS management software (Cat.No 4 306 21)                      Automatic search for cameras connected to the network                      Recording stored on the recorder viewable directly via the web interface                      Built-in motion detection/video masking/multi-zone video blanking with the option of recording the event on a hard disk and/or triggering the recorder's event output contacts and/or sending an email                      PC software for automatic detection on the network and for automatic addressing supplied                      ONVIF compliant (please contact us to get a list of supported references)                      IR remote control, mouse and power supply included</p>			<p>Allows to broadcast locally on up to 4 screens                      Can decode up to 28 IP cameras or 16 analog cameras connected to High Resolution DVR                      4 HDMI outputs</p>
1	4 306 83	16 channels, 2Tb storage, 200 fps @Full HD 1080p 400 fps @HD 720p and D1			
1	4 306 84	32 channels, 4Tb storage, 200fps @Full HD 1080p, 400 fps @HD 720p and 800 fps @D1			
		<p><b>PoE Network video recorders</b>                      Integrated PoE switch to connect directly IP PoE cameras                      Pentaplex: simultaneous live, record, playback, extraction and remote access                      Front, mouse or remotely operated                      Video compression format: H264                      Cameras plugged on the PoE switch are power supplied                      Auto IP set up and detection when cameras are plugged on the switch                      Recordings viewable on Smartphone or PC                      Compatible with VMS management software (Cat. No 4 306 21)                      Automatic search for cameras connected to the network                      ONVIF compliant (please contact us to get a list of supported references)                      Power supply: 230 VA, power consumption: 120 W                      Dimensions (W x H x D): 375 x 285 x 45 mm                      IR remote control, mouse and power supply included</p>			<p><b>IP encoder 1 channel D1</b>                      Allows to connect 1 analog camera onto the network, providing the functionalities of IP cameras</p>
1	4 306 73	1Tb, 4 slots PoE, 100 fps @Full HD 1080p			
1	4 306 90	2 Tb, 8 slots PoE, 100 fps @Full HD 1080p			
					<p><b>4 channels IP encoder D1</b>                      Allows to connect up to 4 analog cameras onto the network, providing the functionalities of IP cameras</p>
					<p><b>Micro-SD card 4 Go</b>                      4 Go memory card for IP camera                      Supplied with SD adaptor</p>
					<p><b>Video surveillance signage</b>                      CCTV sign for installation at the entrance of the building, to identify the presence of a video surveillance system                      Mounting: using screws or double sided tape (supplied)                      Language: English                      Other languages available on demand</p>



## CCTV video monitors



4 305 74



4 305 70



4 305 73

Pack	Cat.Nos	Video monitors
1	4 305 74	<b>7" monitor</b> Colour monitor Screen size 7" (18 cm) Display 16/9 Resolution: 480 x 234 Video input: 2 x BNC Advanced functions: option for connecting 2 recorders or 2 cameras directly
1	4 305 70	<b>17" monitor</b> Colour monitor with TFT active matrix Screen size 17" (43 cm) Display 4/3 Maximum resolution: 1280 x 1024 Brightness: 300 cd/m <sup>2</sup> Video input: BN C / VGA / S Video
1	4 305 71	<b>19" monitor</b> Colour monitor with TFT active matrix Screen size 19" (48 cm) Display 4/3 Maximum resolution: 1280 x 1024 Brightness: 300 cd/m <sup>2</sup> Video input: BNC / VGA / S Video

Pack	Cat.Nos	Video monitors (continued)
1	4 305 72	<b>22" monitor</b> Colour monitor Screen size 22" (56 cm) Display 16/9 Maximum resolution: 1680 X 1050 Brightness: 300 cd/m <sup>2</sup> Video input: HDMI / BNC / VGA / S Video
1	4 305 73	<b>32" monitor</b> Full HD colour monitor Screen size 32" (81 cm) Display 16/9 Maximum resolution: 1920 x 1080 Brightness: 450 cd/m <sup>2</sup> Video input: HDMI / BNC / VGA / S Video
1	4 306 04	<b>Wall mounting support for monitors</b> For 17, 19 and 22" monitors Adjustable mounting (horizontally and vertically)



# Example of installation: analog cameras

## How to connect different types of cameras

### Plug-in power supply

Cat.No 4 305 12



Power supply:  
12 V<sub>DC</sub>

Cat.No 4 305 02



Power supply:  
12 V<sub>DC</sub>

### 230 V power supply



SPEED DOME ID = 1  
Cat.No 4 305 24



SPEED DOME ID = 2  
Cat.No 4 305 21

COAX

COAX

COAX

RS 485

COAX

RS 485



Cat.No 4 305 71

Cat.No 4 307 55



Cat.No 4 306 03



**NOTE:** ensure that the power supply is suitable for the type of camera. The power supply cables must be of adequate cross-section in relation to the distance and the corresponding voltage drop

## Example of installation: IP cameras

### ■ Visualization

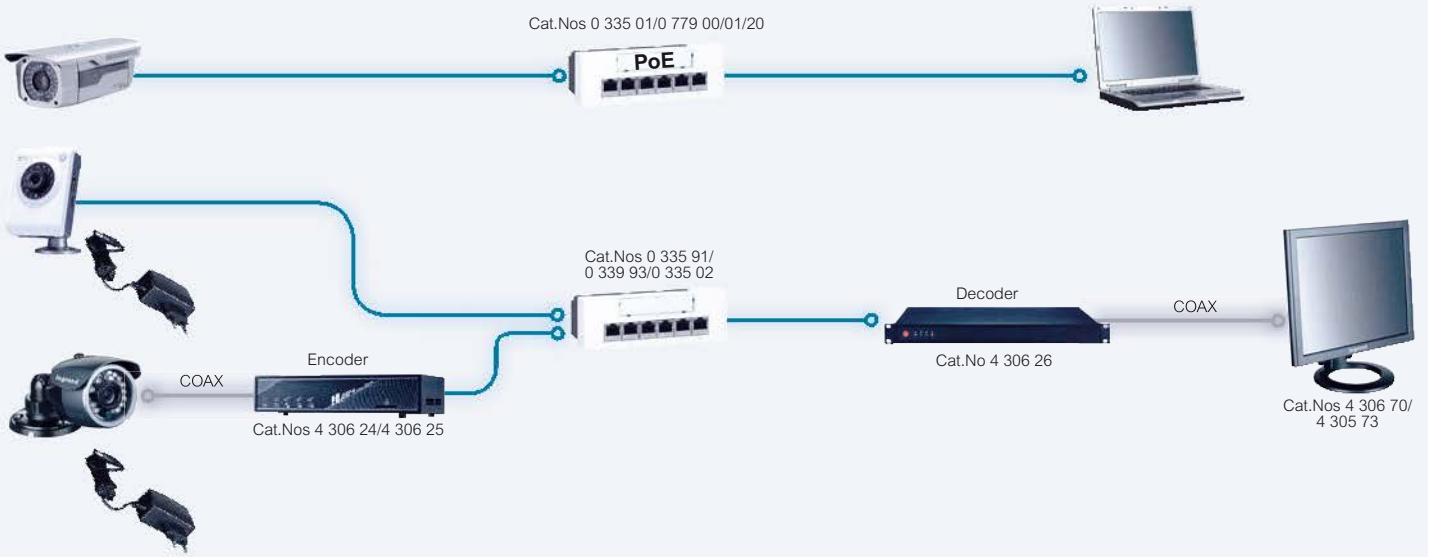

### ■ Recording on dedicated network

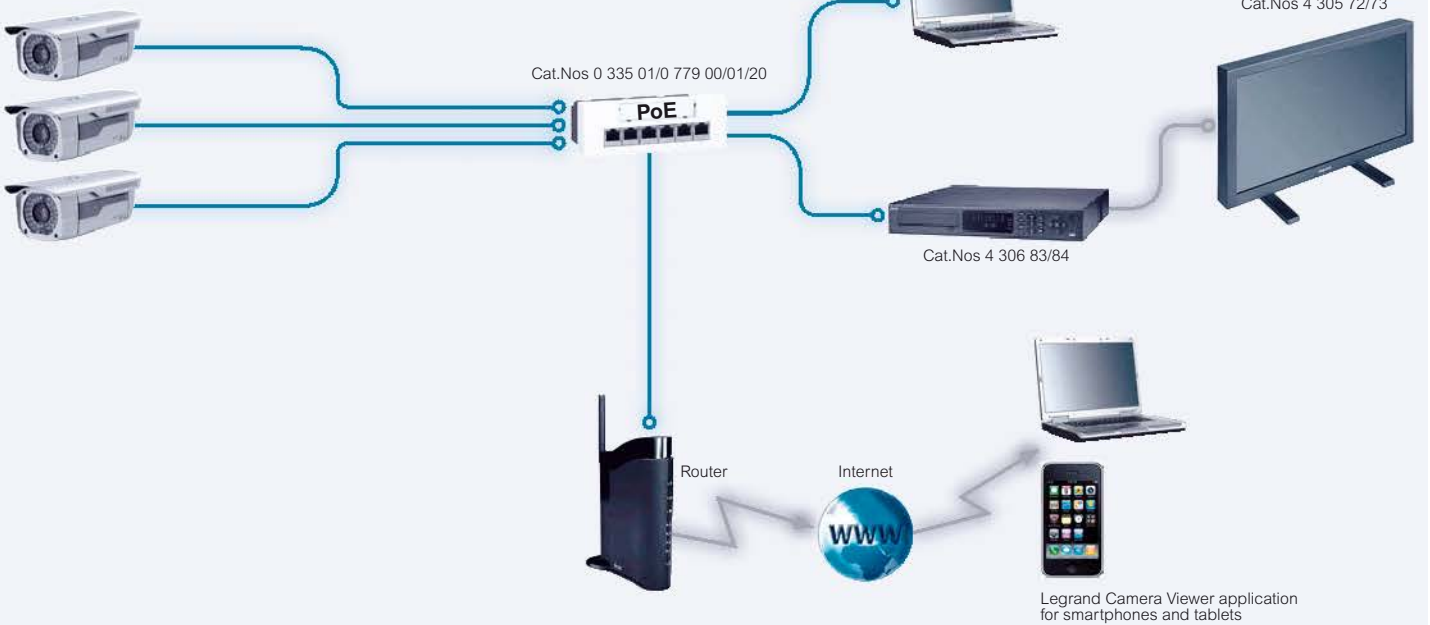

# Fire detection and alarm panels, automatic sensors, manual call points and visual alarm devices



6 430 23



6 430 72



0 380 69



0 405 96

Pack	Cat.Nos	Fire detection and alarm panels
1	6 430 21	<p>Conform to EN54-2, EN54-4, EN 54-13 standards CE CPR approved</p> <p><b>2-zone Salvema panel</b> 2 detection loops 2 sounders or beacons outputs (450 mA) 1 general fire volt free changeover contact (1 A - 24 V<sub>cc</sub>) 1 general fault volt free changeover contact (1 A - 24 V<sub>cc</sub>) Autonomy: 72 hours standby + 30 minutes alarm Battery not supplied (Cat.No 0 407 49)</p>
1	6 430 23	<p><b>8-zone Salvema panel</b> 8 detection loops 2 sounders or beacons outputs (1.2 A) 1 general fire volt free changeover contact (1 A - 24 V<sub>cc</sub>) 1 general fault volt free changeover contact (1 A - 24 V<sub>cc</sub>) 4 auxiliary changeover contacts 24 V - 1 A Programming of auxiliary contacts with detection zones 1 continuous or resettable output 24 V - 200 mA Autonomy: 72 hours standby + 30 minutes alarm Battery not supplied (Cat.No 0 407 53)</p>
1	6 430 65	<p><b>Repeater panel</b> Report of information supplied by the panel (fire, fault, out of order, test) on liquid chrystal display Max. 3 repeater panels by central unit</p>
<p><b>Automatic sensors for fire detection and alarm panels</b></p>		
1	6 430 72	<p><b>Optical smoke sensor</b> Conform to EN 54-7 standard and CE CPR approved For quick detection of fire starting before flames appear Average detection area: 60 m<sup>2</sup> Supplied with its standard base</p>
1	6 430 71	<p><b>Heat sensor</b> Conform to EN 54-5 standard and CE CPR approved Detects temperature rise with threshold of 60°C Average detection area: 30 m<sup>2</sup> Supplied with its standard base</p>
1	6 430 75	<p><b>Relay base</b> For sensors Cat.Nos 6 430 71/72 To act a DVR, a camera or an MCB To send alarm information to a technical panel</p>

Pack	Cat.Nos	Manual call points
1	0 380 69	<p>Surface-mounting: 90 x 90 x 57 mm Flush-mounting: 90 x 90 x 27 mm Call by pressing the membrane (pressure 2.5 kg) with clear display of the call position Reset on front of device, with special key (supplied with the product) Free space dedicated to stick a label to identify the function Can receive a sealable cover Cat.No 0 380 97</p> <p><b>For fire alarm equipment</b> Equipped with NO/NC contact - 0.1 A - 48 V<sub>cc</sub> Red - Resettable Conform to EN 54-11 standard and CE-CPR approved</p> <p><b>For emergency exit</b> Equipped with NO/NC contact - 5 A - 24 V<sub>cc</sub> / 1 A - 48 V<sub>cc</sub></p>
1	0 380 23	1 NO/NC contact - Resettable - Green
1	0 380 48	2 NO/NC contacts - Resettable - Green
1	0 380 25	<p><b>For extinguishing system</b> Equipped with NO/NC contact - 6 A - 250 VA / 1 A - 48 V<sub>cc</sub> / 5 A - 24 V<sub>cc</sub> Equipped with a sealable cover (Cat.No 0 380 97) Resettable - Yellow</p> <p><b>For other applications</b> Equipped with NO/NC contact - 6 A - 250 VA / 1 A - 48 V<sub>cc</sub> / 5 A - 24 V<sub>cc</sub> Can be used to stop air conditioning or other technical applications</p>
1	0 380 71	Resettable - White
1	0 380 06	White - Resettable with 2 long life 230 V <sub>~</sub> LED indicators
1	0 380 97	Sealable cover for manual call points Cat.Nos 0 380 06/23/48/69/71
1	0 380 38	Set of 10 special keys to reset and to test
<p><b>Visual alarm devices</b></p>		
1	0 405 96	<p>Conform to EN 54-23 standard and CE CPR approved</p> <p>Mosaic device - 2 modules Delivered with support frame and dedicated plate IP 40 - IK 04 Red flashing light 2 cd synchronizable with a frequency of 1 Hz Voltage range: 10 - 42 V Average consumption: 12 V<sub>cc</sub> = 14 mA ; 24 V<sub>cc</sub> = 16 mA Surface-mounting IP 45 - IK 07</p>
1	0 405 98	<p>Red flashing light 2/10 cd synchronizable with a frequency of 1 Hz Voltage range: 9 - 58 V Average consumption (2 cd): 12 V<sub>cc</sub> = 14 mA ; 24 V<sub>cc</sub> = 16 mA ; 48 V<sub>cc</sub> = 18 mA Average consumption (10 cd): 12V<sub>cc</sub> = 38 mA ; 24 V<sub>cc</sub> = 40 mA ; 48 V<sub>cc</sub> = 42 mA</p>



Stand-alone smoke alarm sensor  
p. 587



# Sounders, sounder beacons, bells, electromagnetic door holder and safety electrical power supplies



0 405 90



0 405 94



0 406 87

Pack	Cat.Nos	Sounders
1	0 415 07	Conform to EN 54-3 standard and CE CPR approved IP 41 - IK 04 Mosaic device - 2 modules Sound level: 70 dB at 2 meters - NF S 32-001 sound Voltage range: 10 - 42 V Average consumption: 12 Vcc = 5 mA ; 24 Vcc = 9 mA
1	0 405 80	IP 42 - IK 07 Surface-mounting Sound level: 90 dB at 2 meters - NF S 32-001 sound Voltage range: 10 - 58 V Average consumption: 12 Vcc = 5 mA ; 24 Vcc = 9 mA ; 48 Vcc = 13 mA
1	0 405 90	IP 65 - IK 07 Surface-mounting Sound level: 90 dB at 2 meters - NF S 32-001 sound Voltage range: 10 - 42 V Average consumption: 12 Vcc = 5 mA ; 24 Vcc = 9 mA
1	0 405 86	2 cable glands supplied IP 21 - IK 07 Flush-mounting in false ceiling Sound level: 90 dB at 2 meters - NF S 32-001 sound Voltage range: 10 - 58 V Average consumption: 12 Vcc = 5 mA ; 24 Vcc = 9 mA ; 48 Vcc = 13 mA
1	0 405 94	IP 54 - IK 07 Surface-mounting Sound level: 105 dB at 2 meters - Possibility to choose the sound, by dip switch: NF S 32-001 or BS 58391 (alert or alarm) or ISO 8201 or DIN 33404-3 or SS031711 or NEN2575 Voltage range: 14 - 58 V Average consumption: 24 Vcc = 140 mA ; 48 Vcc = 80 mA

Pack	Cat.Nos	Sounder beacons
1	0 405 91	Conform to EN 54-3 standard and CE CPR approved Sound level: 90 dB at 2 meters - NF S 32-001 sound Red flash Voltage range: 10 - 58 V Average consumption: 12 Vcc = 23 mA ; 24 Vcc = 22 mA ; 48Vcc = 23 mA
1	0 405 87	IP 65 - IK 07 Surface-mounting 2 cable glands supplied IP 21 - IK 07 Flush mounting in false ceiling

Pack	Cat.Nos	Bells
1	0 414 62	P 44 - IK 10 Sound level: 90 dB at 2 meters Average consumption: 24 Vcc = 70 mA
1	0 406 87	<b>Electromagnetic door holder</b> Automatically closes fire doors by current breaking White metal connection box with electromagnetic element and local push button Wall surface-mounting Metal washer hinged for door fixing Operating voltage: 24/48 Vcc Average consumption: 24 Vcc = 23 mA ; 48 Vcc = 45 mA Power: 0.6 W / 24 V ; 2.2 W / 48 V Strength: 200 N (or 20 Kg minimum) Conform to EN 11-55 standard IK 07
1	0 405 09	<b>Safety electrical power supplies</b> Conform to EN 54-4, EN 12101-10 CE CPR approved For DC power supply of fire safety installations such as fire doors, smoke removal devices, ... Power supply 3 A - 24 V 2 batteries 12 V 7 Ah (Pb) Cat.No 0 407 49 (not supplied)
1	0 407 49	Battery 12 V 7 Ah (Pb) - V0 (UL 94)

## Safety boxes



0 380 09



0 380 11



0 380 24



0 380 54

Pack	Cat.Nos	Break glass emergency boxes
		<p>Polycarbonate, Class II - IK 07            Equipped with:</p> <ul style="list-style-type: none"> <li>- hinged glass door with locking option by key</li> <li>- 3 cable entries for CG ISO 16/20 (by top or bottom as reversible product)</li> <li>- 2 entries from back of product Ø20</li> <li>- 2 side entries for mini-trunking 20 x 12.5 and 32 x 12.5</li> <li>- 1 NC contact and 1 NO contact</li> </ul> <p>Breaking capacity:</p> <ul style="list-style-type: none"> <li>- 400 VA / 4.5 A</li> <li>- 230 VA / 6 A</li> <li>- 48 V= / 1 A</li> <li>- 24 V= / 1.5 A</li> </ul> <p>Flush-mounting option with boxes Ø85            Dim.: 125 x 125 x 71 mm (surface-mounting) IP 44 -            125 x 125 x 33 mm (flush-mounting) IP 30            Red boxes can be used for fire applications and manipulated by fire fighters            Yellow boxes can be used for emergency applications and manipulated by employees</p> <p><b>Mushroom head button boxes</b>            Direct actuation by smashing glass plate            Equipment:</p> <ul style="list-style-type: none"> <li>- 1 mushroom head button with latching, unlocking by key No 850</li> <li>- 2 long life 230 V± LED indicators (green/red)</li> </ul>
1	0 380 09	Red box with LED
1	0 380 00	Yellow box with LED
1	0 380 02	Yellow box without LED
1	0 380 03	Red box without LED
		<p><b>2-position boxes</b>            Equipment:</p> <ul style="list-style-type: none"> <li>- 1 mushroom head button for pressing</li> <li>- 1 finishing accessory for simple action release (glass break) or double action (glass break followed by pressing on mushroom head)</li> <li>- 2 long life 230 V± LED indicators (green/red)</li> </ul>
1	0 380 11	Red box without LED
1	0 380 01	Yellow box without LED
1	0 380 24	Red box with LED

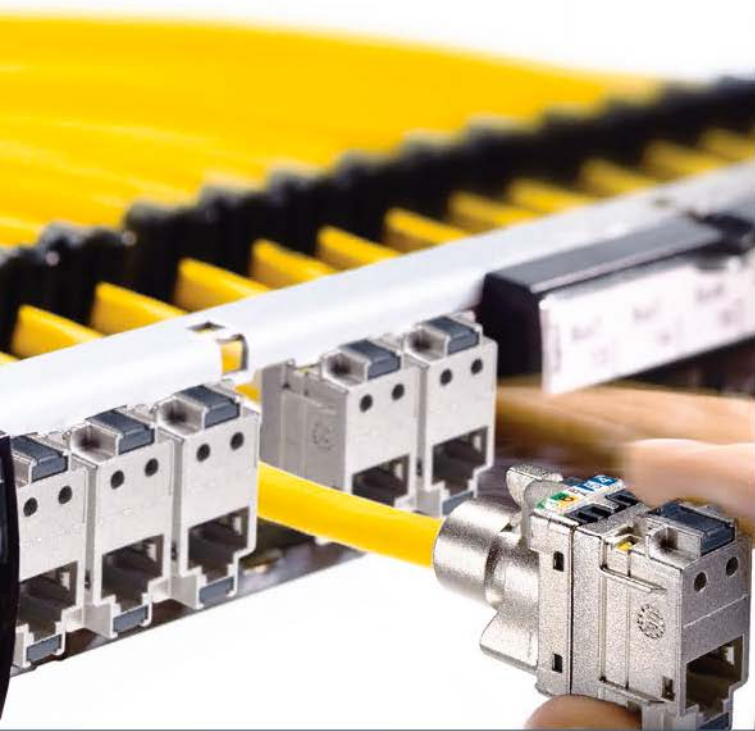

# UPS, LCS<sup>2</sup>, CABLE MANAGEMENT SYSTEMS, EQUIPMENT & ACCESSORIES

## UPS systems (uninterruptible power supplies)



**NEW**  
**P. 654**  
Daker, conventional UPS

## LCS<sup>2</sup> structured cabling



**P. 668**  
Cat. 6A and 6 patch panels, cables, cords and RJ 45 sockets



**P. 688**  
Fibre optic connectors, pigtails, area distribution boxes



**P. 708**  
Linkeo 19" freestanding and wall-mounting cabinets

## DLP cable management



**P. 732**  
DLPlus mini-trunking



**P. 747**  
DLP snap-on trunking

## Workstation systems



**P. 767**  
Aluminium snap-on columns & mini-columns



**P. 776**  
Heavy duty floor boxes

## NEW PRODUCTS 2014



**Keor multiplug**  
stand-by UPS  
(p. 659)



**FTTO - Full IP**  
digital infrastructure  
for all types of  
installation  
(p. 687)



**NEW**  
**P. 657**  
Niky, line  
interactive UPS



**NEW**  
**P. 658**  
Niky S, line  
interactive UPS



**NEW**  
**P. 659**  
Keor multiplug  
stand-by UPS



**P. 676**  
Cat.6A, 6 and 5e  
area distribution  
boxes and cords



**P. 679**  
Cat.5e patch  
panels, cables,  
cords and RJ 45  
sockets



**P. 684**  
Fibre optic cables  
and drawers



**NEW**  
**P. 687**  
FTTO - Full IP



**P. 692**  
Wi-Fi access  
points, switches  
and PoE injectors



**P. 694**  
Audio/video  
system



**P. 698**  
19" freestanding  
and wall-mounting  
cabinets



**P. 706**  
Power Distribution  
Units



**P. 711**  
19" Bati-rack  
and 19" Altis™  
freestanding  
cabinets



**P. 736**  
DLP LED system  
mini-trunking,  
plinth & covers



**P. 737**  
Flush-mounting  
LED lighting  
modules



**P. 740**  
Distribution  
mini-trunking



**P. 745**  
DLP black edition  
snap-on trunking



**P. 750**  
Grey colour  
DLP snap-on  
trunking



**P. 754**  
Universal DLP  
trunking



**P. 762**  
Adaptable  
aluminium  
DLP trunking



**NEW**  
**P. 766**  
Snap-on  
aluminium  
DLP trunking



**P. 768**  
Universal  
columns, mini-  
columns &  
lighting modules



**P. 771**  
Over floor  
trunking



**P. 772**  
Floor boxes for  
carpet



**P. 775**  
Floor boxes for  
tile & marble



**P. 777**  
Pop-up type  
flush-mounting  
boxes



**P. 779**  
Power & data  
desk grommets



**P. 780**  
Desktop & meeting  
room multi-outlet  
extensions



**DLP LED system**  
mini-trunking,  
plinths & covers  
(p. 736)



**Snap-on aluminium**  
**DLP trunking**  
(p. 766)

# Daker Dk

Conventional UPS - On-line double conversion VFI



3 100 50



3 100 54



3 107 71



3 109 53

The main parameters of the UPS, including the battery charge level and faults, are displayed on the LCD screen on the front panel. The integrated communication software not only controls the UPS and its switch-off if there is a malfunction, and enables the user to test the main functions remotely, communicate via SNMP/Internet/network adaptor and access the functions of the UPS via the Internet, but can also send the user an SMS if specific events occur. The internal extension connector enables a WEB/SNMP card or a relay interface to be installed which provides insulated contacts for applications on industrial control panels or remote alarm panels. If there is an electronic fault, overload, overheating or for scheduled maintenance operations, the automatic or manual (optional) bypass ensures continuity of the power supply for critical loads. A bypass switch is available for maintenance.

Pack	Cat.Nos	Convertible UPS with batteries			
		<b>Single phase</b>			
		Nominal power (VA)	Active power (W)	Backup time (min)	Weight (kg)
1	3 100 50	1000	800	10	16
1	3 100 51	2000	1600	10	29.5
1	3 100 52	3000	2400	8	30
1	3 100 53	4500	4050	6	60
1	3 100 54	6000	5400	4	60

Pack	Cat.Nos	Convertible UPS without batteries		
		<b>Single phase</b>		
		Nominal power (VA)	Active power (W)	Weight (kg)
1	3 100 56	4500	4050	25
1	3 100 57	6000	5400	25
1	3 100 58	10000	9000	26
		<b>Three phase</b>		
1	3 100 59	10000	9000	26

Pack	Cat.Nos	Battery cabinet (with batteries)
1	3 107 69	Battery cabinet for 3 100 50 (12 x 12 V, 7.2 Ah batteries)
1	3 107 70	Battery cabinet for 3 100 51 (12 x 12 V, 7.2 Ah batteries)
1	3 107 71	Battery cabinet for 3 100 52 (12 x 12 V, 9 Ah batteries)
1	3 107 72	Battery cabinet for 3 100 56 and 3 100 57 (20 x 12 V, 7.2 Ah batteries)
1	3 107 66	Battery cabinet for 3 100 58 (20 x 12 V, 9 Ah batteries)

Pack	Cat.Nos	Battery cabinet (empty)
1	3 107 50	Battery cabinet for 3 100 50 (for 12 x 12 V, 7.2 Ah batteries)
1	3 107 51	Battery cabinet for 3 100 51 (for 12 x 12 V, 7.2 Ah batteries)
1	3 107 52	Battery cabinet for 3 100 52 (for 12 x 12 V, 9 Ah batteries)
1	3 107 53	Battery cabinet for 3 100 56 and 3 100 57 (for 20 x 12 V, 7.2 Ah batteries)
1	3 107 54	Battery cabinet for 3 100 58 (for 20 x 12 V, 9 Ah batteries)

Pack	Cat.Nos	Miscellaneous accessories
1	3 109 50	Additional 200 W charger (for Daker DK 1000-2000-3000)
1	3 109 54	Additional 1000 W charger (for Daker DK 4500-6000-10000)
1	3 109 52	Rack support bracket kit
1	3 109 53	External manual bypass (for Daker DK 1000-2000-3000)
1	3 109 69	Volt-free contact card

NOTE: The backup times, expressed in minutes, are measured under optimum operating conditions



# Daker Dk

## Conventional UPS - On-line double conversion VFI



Cat.Nos	3 100 50	3 100 51	3 100 52	3 100 53	3 100 56	3 100 54	3 100 57	3 100 58	3 100 59
<b>GENERAL CHARACTERISTICS</b>									
Nominal power (VA)	1000	2000	3000	4500	6000	10000			
Active power (W)	800	1600	2400	4050	5400	9000			
Technology	On-line double conversion VFI-SS-111								
Waveform	Sinusoidal								
Architecture	Convertible tower and 19" rack								
<b>INPUT CHARACTERISTICS</b>									
Input voltage	230 V 1P+N						380 V 3P+N		
Input frequency	50-60 Hz $\pm$ 5% autosensing								
Input voltage range	160 V - 288 V full load						277 V - 485 V		
THD of input current	$<$ 3%								
Input power factor	$>$ 0.99								
Compatibility with gensets	Configurable for synchronism between the input and output frequencies, even for the highest frequency ranges, $\pm$ 14%								
<b>OUTPUT CHARACTERISTICS</b>									
Output voltage	230 V $\pm$ 1%								
Output frequency (nominal)	50/60 Hz (configurable via LCD panel) $\pm$ 0.1%								
Peak factor	1:3								
THD of output voltage	$<$ 3% with linear load								
Output voltage tolerance	$\pm$ 1%								
Bypass	Automatic bypass and optional external manual bypass				Automatic bypass				
<b>BATTERIES</b>									
Backup time extension	Yes								
Number of batteries	3	6	6	20	-	20	-	-	-
Battery range type/voltage	12 V 7.2 Ah	12 V 7.2 Ah	12 V 9 Ah	12 V 5 Ah	-	12 V 5 Ah	-	-	-
Backup time (min)	10	10	8	6	-	4	-	-	-
<b>COMMUNICATION AND MANAGEMENT</b>									
Screen and signalling	Four buttons and four LEDs for real-time control of the status and the main parameters of the UPS								
Communication ports	RS232 and USB serial ports								
Remote control	Available								
Connector for network interface	SNMP								
<b>MECHANICAL CHARACTERISTICS</b>									
Dimensions (H x W x D) (mm)	440 x 88 (2U) x 405	440 x 88 (2U) x 650	440 x 88 (2U) x 650	440 x 176 (4U) x 680	440 x 88 (2U) x 680	440 x 176 (4U) x 680	440 x 88 (2U) x 680	440 x 132 (3U) x 680	440 x 132 (3U) x 680
Dimensions of battery cabinet H x W x D (mm)	440 x 176 (4U) x 405	440 x 88 (2U) x 650	440 x 88 (2U) x 650	-	440 x 132 (3U) x 680	-	440 x 132 (3U) x 680	440 x 132 (3U) x 680	440 x 132 (3U) x 680
Net weight (kg)	16	29.5	30	52	25*	52	25*	26*	26*
<b>AMBIENT CONDITIONS</b>									
Operating temperature (°C)	0 $\div$ 40°C								
Protection index	IP 21								
Relative humidity (%)	20 to 80%								
Noise at 1 m (dBA)	$<$ 50								
Heat dissipation (BTU/h)	490	654	818	982	1310	1636			
<b>CERTIFICATIONS</b>									
Reference product standards	EN 62040-1, EN 62040-2, EN 62040-3								

\* Weight without batteries

NOTE: The backup times, expressed in minutes, are measured under optimum operating conditions



MODEL	POWER	BACKUP TIME	DIMENSIONS AND NUMBER OF CABINETS H x W x D (mm)	Cat.Nos	
				Single phase	Three phase
DAKER DK	1000 VA	10'	440 x 88 x 405	3 100 50	-
		1h22'	440 x 88 x 405 + 440 x 176 x 405	3 100 50 + 3 107 69	-
		2h44'	440 x 88 x 405 + 440 x 176 x 405 (x2)	3 100 50 + 3 107 69 (x2)	-
		4h22'	440 x 88 x 405 + 440 x 176 x 405 (x3)	3 100 50 + 3 107 69 (x3)	-
		5h52'	440 x 88 x 405 + 440 x 176 x 405 (x4)	3 100 50 + 3 107 69 (x4)	-
	2000 VA	10'	440 x 88 x 650	3 100 51	-
		39'	440 x 88 x 650 (x2)	3 100 51 + 3 107 70	-
		1h22'	440 x 88 x 650 (x3)	3 100 51 + 3 107 70 (x2)	-
		1h57'	440 x 88 x 650 (x4)	3 100 51 + 3 107 70 (x3)	-
		2h44'	440 x 88 x 650 (x5)	3 100 51 + 3 107 70 (x4)	-
	3000 VA	8'	440 x 88 x 650	3 100 52	-
		34'	440 x 88 x 650 (x2)	3 100 52 + 3 107 71	-
		1h6'	440 x 88 x 650 (x3)	3 100 52 + 3 107 71 (x2)	-
		1h33'	440 x 88 x 650 (x4)	3 100 52 + 3 107 71 (x3)	-
		2h3'	440 x 88 x 650 (x5)	3 100 52 + 3 107 71 (x4)	-
	4500 VA	10'	440 x 88 x 650 + 440 x 132 x 680	3 100 56 + 3 107 72	-
		31'	440 x 88 x 650 + 440 x 132 x 680 (x2)	3 100 56 + 3 107 72 (x2)	-
		56'	440 x 88 x 650 + 440 x 132 x 680 (x3)	3 100 56 + 3 107 72 (x3)	-
		1h30'	440 x 88 x 650 + 440 x 132 x 680 (x4)	3 100 56 + 3 107 72 (x4)	-
	6000 VA	10'	440 x 88 x 650 + 440 x 132 x 680	3 100 57 + 3 107 72	-
		29'	440 x 88 x 650 + 440 x 132 x 680 (x2)	3 100 57 + 3 107 72 (x2)	-
		49'	440 x 88 x 650 + 440 x 132 x 680 (x3)	3 100 57 + 3 107 72 (x3)	-
		1h11'	440 x 88 x 650 + 440 x 132 x 680 (x4)	3 100 57 + 3 107 72 (x4)	-
	10000 VA	7'	440 x 132 x 650 + 440 x 132 x 680	3 100 58 + 3 107 66	3 100 59 + 3 107 66
		18'	440 x 132 x 650 + 440 x 132 x 680 (x2)	3 100 58 + 3 107 66 (x2)	3 100 59 + 3 107 66 (x2)
29'		440 x 132 x 650 + 440 x 132 x 680 (x3)	3 100 58 + 3 107 66 (x3)	3 100 59 + 3 107 66 (x3)	
42'		440 x 132 x 650 + 440 x 132 x 680 (x4)	3 100 58 + 3 107 66 (x4)	3 100 59 + 3 107 66 (x4)	
56'		440 x 132 x 650 + 440 x 132 x 680 (x5)	3 100 58 + 3 107 66 (x5)	3 100 59 + 3 107 66 (x5)	

NOTE: The backup times, expressed in minutes, are measured under optimum operating conditions

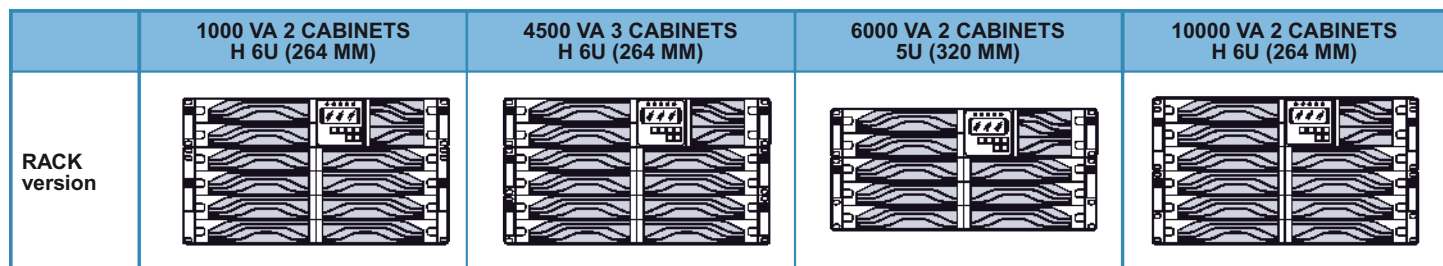
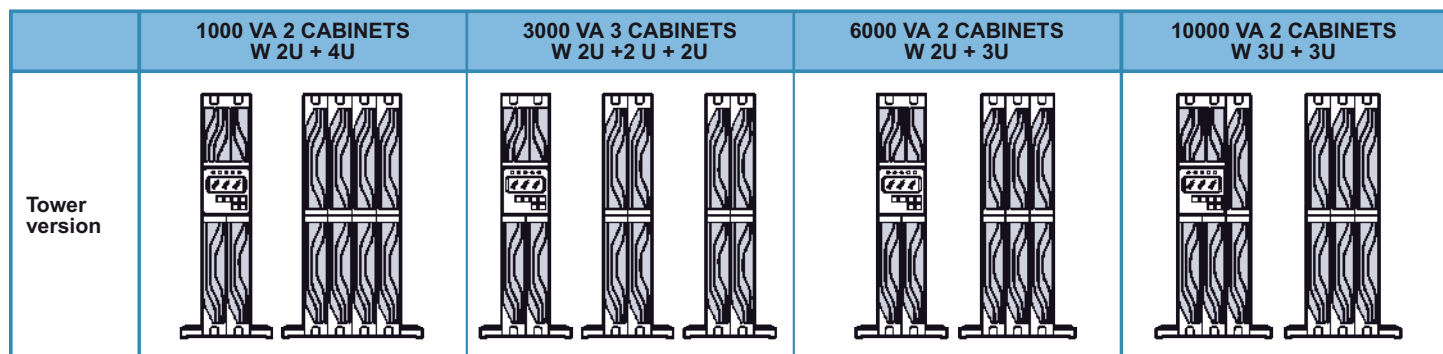

# Niky

## Line Interactive UPS - Single phase VI



# Niky

## Line Interactive UPS - Single phase VI



3 100 00

3 100 13

Pack	Cat.Nos	UPS with German and Italian standard output sockets					
		Nominal power (VA)	Active power (W)	Backup time (min)	No. of German standard sockets	Communic. ports	
1	3 100 00	600	300	3 to 30	1	USB	
1	3 100 01	800	400	3 to 30	1	USB	
		Nominal power (VA)	Active power (W)	Backup time (min)	No. of sockets IEC	No. of German standard sockets	Communic. ports
1	3 100 09	600	300	5 to 30	1	1	USB
1	3 100 10	800	400	5 to 30	1	1	USB
1	3 100 13	1000	600	5 to 30	2	2	RS232
1	3 100 14	1500	900	5 to 30	2	2	RS232
		Nominal power (VA)	Active power (W)	Backup time (min)	No. of sockets IEC	Communic. ports	
1	3 100 02	600	300	5 to 30	3	USB	
1	3 100 03	800	400	5 to 30	3	USB	
1	3 100 04	1000	600	5 to 30	6	USB	
1	3 100 05	1500	900	5 to 30	6	USB	

NOTE: The backup times, expressed in minutes, are measured under optimum operating conditions

Cat.Nos	3 100 00 <sup>1</sup> 3 100 02 3 100 09	3 100 01 <sup>2</sup> 3 100 03 3 100 10	3 100 04 3 100 13	3 100 05 3 100 14
<b>GENERAL CHARACTERISTICS</b>				
Nominal power (VA)	600	800	1000	1500
Active power (W)	300	400	600	900
Technology	Line interactive VI			
Waveform	Pseudo-sinusoidal			
<b>INPUT CHARACTERISTICS</b>				
Input voltage	230 V			
Input frequency	50-60 Hz			
Input voltage range	160 V-290 V			
<b>OUTPUT CHARACTERISTICS</b>				
Output voltage	230 V ± 10%			
Output frequency (nominal)	50/60 Hz +/-1%			
THD of output voltage	< 3% with linear load			
<b>BATTERIES</b>				
Number of batteries	1	1	2	2
Battery range type/voltage	12 V, 7 Ah	12 V, 9 Ah	12 V, 7 Ah	12 V, 9 Ah
<b>COMMUNICATION AND MANAGEMENT</b>				
Screen and signalling	One button and 2 LEDs for real-time control		One button and 4 LEDs for real-time control	
Telephone protection	RJ 11/RJ 45			
Remote control	Available			
<b>MECHANICAL CHARACTERISTICS</b>				
Dimensions H x W x D (MM)	171 x 95 x 349		239 x 147 x 354	
Net weight (kg)	7	7.5	13	16
<b>AMBIENT CONDITIONS</b>				
Ambient operating temperature (°C)	0 to 40°C			
Relative humidity (%)	0 to 95%			
Noise at 1 m (dBA)	< 40			
<b>CERTIFICATIONS</b>				
Reference product standards	EN 62040-1, EN 62040-2, EN 62040-3			

1: Battery range type/voltage: 12 V, 5 Ah  
2: Battery range type/voltage: 12 V, 7 Ah

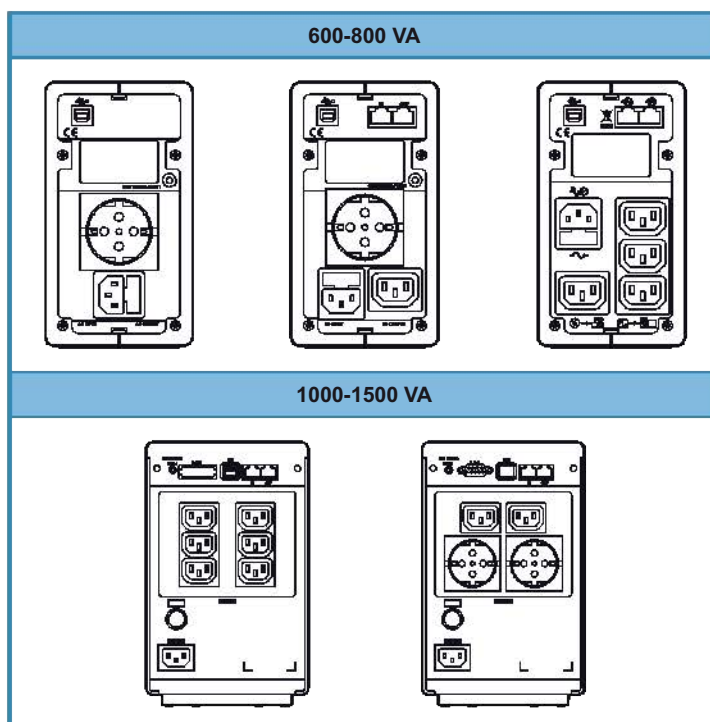

# Niky S

Line Interactive UPS - Single phase VI-SS



3 100 06

Pack	Cat.Nos	UPS	Nominal power (VA)	Active power (W)	Backup time (min)	No. of sockets IEC	Communic. ports
1	3 100 06		1000	600	9	6	USB-RS 232
1	3 100 20		1500	900	8	6	USB-RS 232
1	3 100 07		2000	1200	9	6	USB-RS 232
1	3 100 08		3000	1800	8	6	USB-RS 232

NOTE: The backup times, expressed in minutes, are measured under optimum operating conditions



# Niky S

Line Interactive UPS - Single phase VI-SS



Cat.Nos	3 100 06	3 100 20	3 100 07	3 100 08
<b>GENERAL CHARACTERISTICS</b>				
Nominal power (VA)	1000	1500	2000	3000
Active power (W)	600	900	1200	1800
Technology	Line interactive VI-SS			
Waveform	Sinusoidal			
<b>INPUT CHARACTERISTICS</b>				
Input voltage	230 V ± 12% via mains ± 5% via battery			
Input frequency	50-60 Hz			
Input voltage range	160 V-290 V			
<b>OUTPUT CHARACTERISTICS</b>				
Output voltage	230 V ± 10%			
Output frequency (nominal)	50/60 Hz +/- 0.2%			
THD of output voltage	< 3% with linear load			
<b>BATTERIES</b>				
Number of batteries	2	2	4	4
Battery range type/voltage	12 V, 7 Ah	12 V, 9 Ah	12 V, 7 Ah	12 V, 9 Ah
<b>COMMUNICATION AND MANAGEMENT</b>				
Screen and signalling	Three buttons and three LEDs for real-time control of the status of the UPS			
Telephone protection	RJ 11/RJ 45			
Remote control	Available			
<b>MECHANICAL CHARACTERISTICS</b>				
Dimensions H x W x D (mm)	247 x 173 x 369		247 x 173 x 465	
Net weight (kg)	13	15	22	24
<b>AMBIENT CONDITIONS</b>				
Ambient operating temperature (°C)	0 to 40°C			
Relative humidity (%)	0 to 95% non-condensing			
Noise at 1 m (dBA)	< 40			
<b>CERTIFICATIONS</b>				
Reference product standards	EN 62040-1, EN 62040-2, EN 62040-3			

### 1000-1500-2000 VA

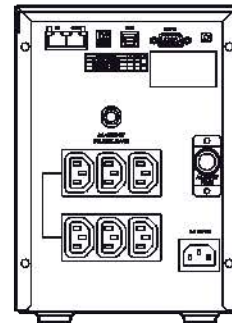

### 3000 VA

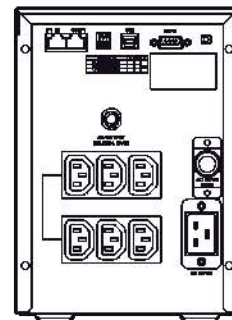

# Keor multiplug

Stand by UPS 600 and 800 VA



# Keor multiplug

Stand by UPS 600 and 800 VA



3 100 38

Pack	Cat.Nos	UPS
		Stand by UPS German and Italian standard output sockets 6 UPS protected sockets 2 spike protected sockets RJ 45/RJ 11 telephone protection
1	3 100 38	Nominal power (VA) 600 Active power (W) 360 Backup time (min) 10 to 15 No. of sockets IEC 6 + 2 Communic. ports USB
1	3 100 39	Nominal power (VA) 800 Active power (W) 480 Backup time (min) 10 to 15 No. of sockets IEC 6 + 2 Communic. ports USB

NOTE: The backup times, expressed in minutes, are measured under optimum operating conditions

Cat.Nos	3 100 38	3 100 39
<b>GENERAL CHARACTERISTICS</b>		
Nominal power (VA)	600	800
Active power (W)	360	480
Technology	Stand by	
Waveform	Sine, step wave (43%-80% duty) or generator input	
<b>INPUT CHARACTERISTICS</b>		
Nominal voltage	230 V	
Line low detect	180 V ± 5%	
Line low come back	190 V ± 5%	
Line high detect	270 V ± 5%	
Line high come detect	260 V ± 5%	
Nominal frequency	50 Hz	
<b>OUTPUT CHARACTERISTICS</b>		
Battery mode voltage	230 V ± 10%	
Battery mode frequency (nominal)	50/60 Hz ± 1 Hz	
Pure Xll capacitance load	1.2 µF	
Battery mode peak voltage	230 V < Vp < 400 V	
Transfer time	2 to 6 ms typical	
<b>BATTERIES</b>		
Battery range type/voltage	12 V, 7 Ah	12 V, 9 Ah
Recharge time	8 hours max. (to 90% capacity)	
<b>COMMUNICATION AND MANAGEMENT</b>		
USB	YES	
Telephone protection	RJ 11/RJ 45	
<b>MECHANICAL CHARACTERISTICS</b>		
Dimensions H x W x D (mm)	229 x 250 x 97.5	
Net weight (kg)	4	4
<b>AMBIENT CONDITIONS</b>		
Ambient operating temperature (°C)	0 to 40°C	
Relative humidity (%)	0 to 90% RH	
Noise at 1 m (dBA)	Line mode	< 40
	Battery mode	< 45
<b>CERTIFICATIONS</b>		
Reference product standards	EN 62040-1, EN 62040-2, EN 62040-3	

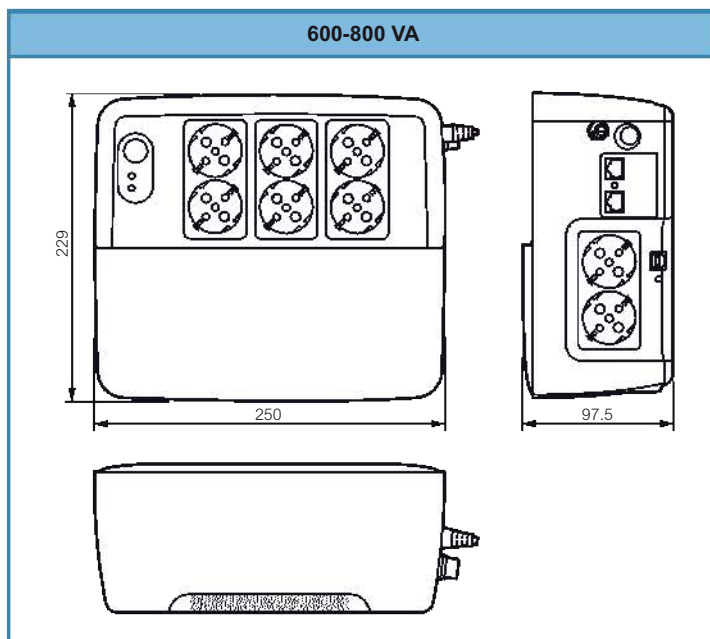

## Selection chart for equipment and cabinets

configure your LCS<sup>2</sup> system

LCS <sup>2</sup> PANELS AND CONNECTOR UNITS (p. 668, 672, 679)			LCS <sup>2</sup> cat. 6 <sub>A</sub>	LCS <sup>2</sup> cat. 6	LCS <sup>2</sup> cat.5e
	Patch panels 1U Fitted with 24 connectors	STP	Quick-fixing 0 335 73	Quick-fixing 0 335 63	-
		FTP	-	Quick-fixing 0 335 62	Quick-fixing 0 335 52
	High density patch panels	STP	Quick-fixing 0 335 86	-	-
		FTP	-	Quick-fixing 0 335 68	-
		UTP	-	Quick-fixing 0 335 67	-
	Units of 6 x RJ 45 connectors	STP	0 335 76	0 335 66	-
FTP		-	0 335 65	0 335 55	
Blanking plate		0 335 91	0 335 91	0 335 91	
Patch panel 1 U To be fitted with 4 units		Quick-fixing 0 335 90	Quick-fixing 0 335 90	0 335 90	
ADDITIONAL LCS <sup>2</sup> PANELS AND UNITS (p. 681 to 683)					
			LCS <sup>2</sup>		
	Telephone panels 1 U Fitted with 4 units of 12 ports	3-6/4-5 contacts (digital)	Quick-fixing	0 335 31	
		4-5/7-8 contacts (analogue)		0 335 30	
	Telephone units Fitted with 12 ports	3-6/4-5 contacts (digital)		0 335 33	
		4-5/7-8 contacts (analogue)		0 335 32	
	Doublers units	Ethernet/Ethernet FTP		0 335 39	
		Telephone/Ethernet FTP		0 335 37	
		Telephone/telephone		0 335 35	
	Video streaming unit	6 x "F" connectors		0 335 34	
	Switch units	7 x RJ 45 ports		0 335 02	
		6 x RJ 45 ports + 1 LC type optic port		0 335 05	
Power over Ethernet (PoE) injector	4 ports		0 335 01		
Controlled access units			0 334 71/72/73/74/75		
LCS <sup>2</sup> 19" FEEDTHROUGH PANELS AND BLANKING PLATES (p. 702)					
	Metal, 2 axes	1 U	Quick-fixing	0 465 22	
		2 U		0 465 23	
	Plastic with brushes, snap on	1 U		0 465 28	
		2 U		0 465 29	
	Metal with brushes	1 U	Quick-fixing	0 465 30	
		2 U		0 465 31	
	Plastic blanking plate, snap on	1 U		0 465 32	
		2 U		0 465 33	
	Metal blanking plate	1 U	Quick-fixing	0 465 38	
		2 U		0 465 39	
		3 U		0 465 40	
	LCS <sup>2</sup> ZONE DISTRIBUTION BOXES (p. 668, 672, 676, 679)			LCS <sup>2</sup> cat. 6 <sub>A</sub>	LCS <sup>2</sup> cat. 6
	Zone distribution box Equipped with 12 x RJ 45 connectors	STP	0 335 49	0 335 46	-
		FTP	-	0 335 45	-
		UTP	-	0 335 44	-
	Units of 6 x RJ 45 connectors	STP	-	0 335 66	-
		FTP	-	0 335 65	0 335 55
		UTP	0 335 77	0 335 64	0 335 54
Fibre optic accessory		-	0 335 20	0 335 20	
Zone distribution box - To be fitted with 4 units		-	0 335 40	0 335 40	

Cords specifically for zone distribution boxes  
p. 676-677



## Selection chart for equipment and cabinets

configure your LCS<sup>2</sup> system (continued)

RJ 45 PATCH CORDS AND USER CORDS (p. 669, 673, 679)				LCS <sup>2</sup> cat. 6 <sub>A</sub>	LCS <sup>2</sup> cat. 6	LCS <sup>2</sup> cat. 5e			
	PVC	S/FTP	Impedance 100 ohms	1 m	0 517 80	0 517 52	-		
				2 m	0 517 81	0 517 53	-		
				3 m	0 517 82	0 517 54	-		
		F/UTP	Impedance 100 ohms	1 m	-	0 517 62	0 516 40		
				2 m	-	0 517 63	0 516 41		
				3 m	-	0 517 64	0 516 42		
	U/UTP	Impedance 100 ohms	1 m	0 518 82	0 517 72	-			
			2 m	0 518 83	0 517 73	-			
			3 m	0 518 84	0 517 74	-			
		LSOH	S/FTP	Impedance 100 ohms	1 m	RAL 3020	0 518 70	-	-
						RAL 6026	0 518 66	-	-
					2 m	RAL 3020	0 518 71	-	-
RAL 6026						0 518 67	-	-	
3 m					RAL 3020	0 518 72	-	-	
					RAL 6026	0 518 68	-	-	
5 m			RAL 3020	0 518 73	-	-			
			RAL 6026	0 518 69	-	-			
F/UTP			Impedance 100 ohms	1 m	RAL 3020	-	0 518 54	-	
					RAL 6026	-	0 518 50	-	
				2 m	RAL 3020	-	0 518 55	-	
					RAL 6026	-	0 518 51	-	
		3 m		RAL 3020	-	0 518 56	-		
				RAL 6026	-	0 518 52	-		
5 m		RAL 3020	-	0 518 57	-				
		RAL 6026	-	0 518 53	-				
U/UTP		Impedance 100 ohms	1 m	RAL 3020	0 518 78	0 518 62	-		
				RAL 6026	0 518 74	0 518 58	-		
			2 m	RAL 3020	0 518 79	0 518 63	-		
				RAL 6026	0 518 75	0 518 59	-		
			3 m	RAL 3020	0 518 80	0 518 64	-		
				RAL 6026	0 518 76	0 518 60	-		
5 m		RAL 3020	0 518 81	0 518 65	-				
		RAL 6026	0 518 77	0 518 61	-				
<b>COPPER CABLES (305 OR 500 M REELS) (p. 669, 673, 679)</b>									
	S/FTP	4 pairs	500 m	0 327 77	-	-			
	SF/UTP	4 pairs	500 m	-	0 327 57	-			
		2 x 4 pairs	500 m	-	0 328 59	-			
	F/UTP	4 pairs	305 m	-	0 328 56	0 327 52			
			500 m	0 327 78	0 327 56	0 328 50			
		2 x 4 pairs	500 m	0 328 78	0 327 76	0 327 74			
			305 m	-	0 327 54	0 327 50			
	U/UTP	4 pairs	500 m	0 327 87	0 328 61	0 328 53			
2 x 4 pairs		500 m	-	0 328 63	0 327 73				
<b>FIBRE OPTIC PATCH CORDS (p. 691)</b>				<b>OS1/OS2 (UPC) singlemode 9/125 µm</b>	<b>OM4 multimode 50/125 µm</b>	<b>OM3 multimode 50/125 µm</b>			
	SC/SC duplex cords	1 m	0 326 00	0 326 30	0 326 09				
		2 m	0 326 01	0 326 31	0 326 10				
		3 m	0 326 02	0 326 32	0 326 11				
	SC/LC duplex cords	1 m	0 326 03	-	0 326 12				
		2 m	0 326 04	-	0 326 13				
		3 m	0 326 05	-	0 326 14				
	LC/LC duplex cords	0.5 m	0 326 28	0 326 33	-				
		1 m	0 326 06	0 326 34	0 326 15				
		2 m	0 326 07	0 326 35	0 326 16				
		3 m	0 326 08	0 326 36	0 326 17				
		5 m	0 326 29	0 326 37	-				
	<b>OPTICAL CABLES (REEL) (p. 684)</b>								
	Indoor/Outdoor	6 fibres	Loose tube	0 325 12	0 326 65/66	0 325 10			
			Tight buffer	0 325 14	-	-			
		12 fibres	Tight buffer	0 325 50	0 326 67	0 325 11			
			Loose tube	0 325 51	-	0 325 53			
	24 fibres	Tight buffer	-	0 326 68	0 325 52				
		Loose tube	-	-	-				
Outdoor, reinforced steel, anti-rodent	6 fibres	0 325 13	-	-					
	12 fibres	0 325 15	-	-					

## Selection chart for equipment and cabinets





configure your LCS<sup>2</sup> system (continued)

PLAIN MOSAIC RJ 45 SOCKETS (p. 670, 674, 677, 680)			LCS <sup>2</sup> cat. 6 <sub>A</sub>	LCS <sup>2</sup> cat. 6	LCS <sup>2</sup> cat.5e
	1 module	STP	0 765 73	0 765 63	-
		FTP	-	0 765 62	-
		UTP	0 765 71	0 765 61	0 765 51
	2 modules	STP	0 765 76	0 765 66	-
		FTP	-	0 765 65	-
		UTP	0 765 74	0 765 64	0 765 54
	2 x 45° modules	STP	0 765 08	0 765 07	-
		FTP	-	0 765 05	-
		UTP	0 765 09	0 765 03	0 765 01
	90° sockets	STP	-	0 765 93	-
		FTP	-	0 765 92	-
		UTP	-	0 765 91	-
	Antimicrobial	STP	0 765 84	0 765 83	-
		FTP	-	0 765 82	-
		UTP	-	0 765 81	-
With controlled access	STP	0 765 99	0 765 96	-	
	FTP	-	0 765 95	-	
	UTP	0 765 90	0 765 94	0 765 97	
Green shutter	STP	0 765 24	-	-	
	FTP	-	0 765 22	-	
Orange shutter	STP	0 765 25	-	-	
	FTP	-	0 765 23	-	
2 x RJ 45 sockets	FTP	-	0 765 46	-	
	UTP	-	0 765 44	0 765 41	
Copper feedthroughs	STP	0 786 28	-	-	
	FTP	-	0 786 23	-	
	UTP	-	0 786 22	0 786 20	
Doubler sockets	Ethernet/Ethernet	FTP	0 765 39	0 765 39	-
		UTP	0 765 38	0 765 38	0 765 38
	Telephone/Ethernet	FTP	0 765 37	0 765 37	-
		UTP	0 765 36	0 765 36	0 765 36
	Telephone/telephone	UTP	0 765 35	0 765 35	0 765 35
<b>WI-FI ACCESS POINTS (p. 692-693)</b>					
	Wall-mounted manageable Wi-Fi access points	With RJ 45 socket, dual-band and dual-radio	0 779 14	0 779 14	0 779 14
		Dual-band and dual-radio	0 779 13	0 779 13	0 779 13
	Manageable Wi-Fi access point (false ceiling)		0 335 21	0 335 21	0 335 21
	Manageable Wi-Fi access point (surface-mounted)		0 335 22	0 335 22	0 335 22
	Centralised configuration software		0 335 24	0 335 24	0 335 24
	PoE injector	4 inputs/4 outputs	0 335 01	0 335 01	0 335 01
		1 input/1 output	0 327 37	0 327 37	0 327 37
<b>FIBRE OPTIC EQUIPMENT (p. 685)</b>			<b>Monomode</b>	<b>Multimode</b>	
	LC units	For 6 fibres	0 335 13	0 335 18	
		High density - For 12 fibres	-	0 335 19	
	SC units	For 6 fibres	0 335 12	0 335 17	
	ST unit	For 6 fibres	-	0 335 16	
	Copper/fibre optic converters	10/100 base T to 10/100 base SX	-	-	0 335 06
		1000 base T to 1000 base SX/LX	-	-	0 335 07
	Switch units	6 x RJ 45 ports + 1 LC type optic port	-	0 335 05	
	Fibre optic racks 1 U - For 4 fibre optic units		-	0 335 10	
	Fibre optic cassettes for patch panel		-	0 335 11	

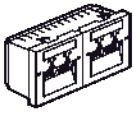

## Selection chart for equipment and cabinets

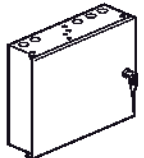
for FTTO infrastructure

		EQUIPMENT FOR INDIVIDUAL WORKSTATIONS		EQUIPMENT FOR SHARED WORKSTATIONS		
  	RJ 45 socket, cat. 6 - FTP - 2 modules		0 765 65	Fibre optic/copper converter switch		0 779 05
	Cat. 6 cords - RJ 45/stripped - F/UTP	Length 8 m	0 517 96	Power supply for fibre optic/copper switch		0 779 06
		Length 15 m	0 517 97	OM3 multimode optical cord 50/125 µm - SC/LC	3 m	0 326 14
	Active zone box		0 326 80		SC/LC > 3 m	consult our customised offer
	False ceiling support for active zone box		0 326 81	Ready-assembled zone distribution box		0 335 43
	Raised access floor support for active zone box		0 326 82			
<b>ZONE BOX &lt;-&gt; FLOOR DISTRIBUTOR LINK</b>						
	Fast-connection connector 50 µm OM3/OM4 900 µm - LC/UPC		0 326 58	Fast-connection connector 50 µm OM3/OM4 900 µm - SC/UPC		0 326 57
	Pigtail 10 Giga - OM3 - 50/125 µm - LC		0 326 23	Pigtail 10 Gb - OM3 - 50/125 µm - SC		0 326 22
	OM3 multimode fibre optic cable 50/125 µm - 6 fibres					0 325 10
<b>EQUIPMENT FOR FLOOR DISTRIBUTOR</b>						
	Modular cabinet					0 462 90
	Fibre optic floor distributor cabinet - ready-assembled					0 462 91
	Fast-connection connector - 50 µm OM3/OM4 900 µm - SC/UPC					0 326 57 x 2
	Pigtail 10 Gb - OM3 - 50/125 µm - SC					0 326 22 x 2
<b>FLOOR DISTRIBUTOR &lt;-&gt; BUILDING DISTRIBUTOR LINK</b>						
	Pigtail 10 Gb - SC (for input) - OM3 - 50/125 µm - SC (incoming)					0 326 22
	OM3 multimode fibre optic cable 50/125 µm - 24 fibres					0 325 52
	Pigtail 10 Gb - SC (for output) - OM3 - 50/125 µm - SC (outgoing)					0 326 22
<b>EQUIPMENT IN THE GENERAL BUILDING DISTRIBUTOR</b>						
	19'' fibre optic drawer - equipped with SC units					0 335 09
	Fast-connection connector - 50 µm OM3/OM4 900 µm - SC/UPC					0 326 57
	Pigtail 10 Gb - OM3 - 50/125 µm - SC					0 326 22

## Selection chart for panels and cords for audio/video applications

ASSEMBLED PANELS, AUDIO/VIDEO APPLICATIONS (p. 696)		
	19" panel equipped with HD 15 units	0 335 98
	19" panel equipped with HDMI units	0 335 97
	19" panel equipped with XLR units	0 335 96
	19" panel equipped with 9-way SUB-D units	0 335 99
CORDS FOR AUDIO/VIDEO APPLICATIONS (p. 696)		
	HD 15 cord - 10 m	0 517 23
	HD 15 cord + 3.5 mm jack - 2 m	0 517 22
	HDMI 1.4 cord - 10 m	0 517 20
	HDMI 1.4 cord - 5 m	0 517 27
	HDMI 1.4 cord - 1.5 m	0 517 26
	XLR cord - 10 m	0 517 24
	9-way SUB-D cord - 10 m	0 517 25
CABLES FOR AUDIO/VIDEO APPLICATIONS (p. 696)		
	VGA cable - 20 m	0 327 81
	HDMI cable - 20 m	0 327 80

# Selection chart for equipment and cabinets



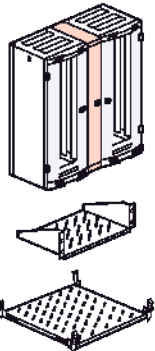
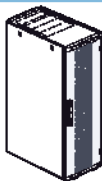
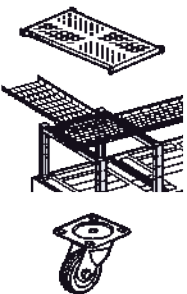
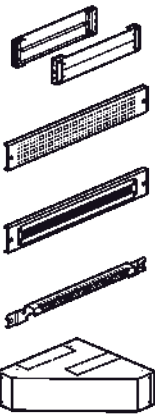



configure your LCS<sup>2</sup> system

LCS <sup>2</sup> 19" CABINETS (p. 698)				Depth 600 mm	Depth 800 mm	Depth 1000 mm
	Single front door	24 U	Width 600 mm	0 463 00	-	-
		29 U	Width 600 mm	0 463 06	-	-
		33 U	Width 600 mm	0 463 12	-	-
		42 U	Width 600 mm	0 463 18	0 463 19	-
			Width 800 mm	0 463 21	0 463 22	0 463 23
		42 U extension <sup>(1)</sup>	Width 600 mm	0 463 30	-	-
	Width 800 mm		-	0 463 33	-	
Double front door	42 U	Width 800 mm	-	0 463 28	0 463 29	
EQUIPMENT FOR LCS <sup>2</sup> 19" CABINETS (p. 698, 702)				For cabinet depth 600 mm	For cabinet depth 800 mm	For cabinet depth 1000 mm
	Cabling unit for 42 U cabinet			0 463 34	0 463 35	-
	Direct baying kit			0 463 37	0 463 38	0 463 39
	Fixed shelf Projecting fixing on 2 x 19" uprights, 2 U	Depth 115 mm		0 465 00	0 465 00	0 465 00
		Depth 200 mm		0 465 01	0 465 01	0 465 01
		Depth 360 mm		0 465 02	0 465 02	0 465 02
	Fixed shelf Fixing on 4 x 19" uprights	50 kg max., 1 U		0 465 05	0 465 06	0 465 07
		100 kg max., 1 U		-	-	0 465 17
Telescopic shelf, fixing on 4 x 19" uprights, 1 U			0 465 08	0 465 09	0 465 10	
Set of 2 fixed runners			0 465 11	0 465 12	0 465 13	
LCS <sup>2</sup> 19" SERVER CABINETS (p. 698)				Depth 1000 mm		
	42 U	Width 600 mm		0 463 85		
		Width 800 mm		0 463 86		
EQUIPMENT FOR LCS <sup>2</sup> 19" SERVER CABINETS (p. 698, 702)				For cabinet depth 1000 mm		
	Baying kit			0 463 39		
	Fixed shelf Projecting fixing on 2 x 19" uprights, 2 U	Depth 115 mm		0 465 00		
		Depth 200 mm		0 465 01		
		Depth 360 mm		0 465 02		
	Fixed shelf Fixing on 4 x 19" uprights	50 kg max., 1 U		0 465 07		
		100 kg max., 1 U		0 465 17		
	Telescopic shelf Fixing on 4 x 19" uprights	50 kg max., 1 U		0 465 10		
		100 kg max., 2 U		0 465 18		
Set of 2 fixed slidders			0 465 13			
Cable guide support			0 464 79 (+ 0 464 78)			
Set of 4 casters, 500 kg max.			0 464 82			
PLINTH FOR LCS <sup>2</sup> 19" CABINETS AND SERVER CABINETS (p. 700)						
	Plinth kit, height 100 mm	For cabinet width 600 mm		0 464 50		
		For cabinet width 800 mm		0 464 51		
	Plinth kit, height 200 mm	For cabinet width 600 mm		0 464 52		
		For cabinet width 800 mm		0 464 53		
	Set of 2 solid side traps	For cabinet depth 600 mm		0 464 54 <sup>(2)</sup>		
		For cabinet depth 800 mm		0 464 56 <sup>(2)</sup>		
		For cabinet depth 1000 mm		0 464 58 <sup>(2)</sup>		
	Ventilated trap, height 100 mm	For cabinet width/depth 600 mm		0 464 60		
		For cabinet width/depth 800 mm		0 464 61		
	Trap with brushes, height 100 mm	For cabinet width/depth 600 mm		0 464 62		
		For cabinet width/depth 800 mm		0 464 63		
	Cross bar	For cabinet depth 600 mm		0 476 93		
For cabinet depth 800 mm		0 476 94				
For cabinet depth 1000 mm		0 476 95				
Linking interface			For cabinet depth 600 mm			
Plinth for cabling unit, trap height 100 mm			0 464 64 <sup>(2)</sup>			

1: Cabinets with no side panels supplied with baying kit - 2: Double the number of traps for a height of 200 mm

## Selection chart for equipment and cabinets

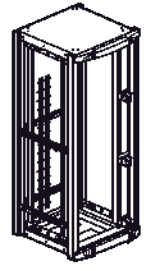
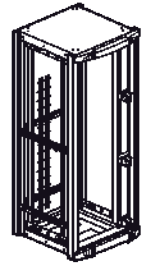
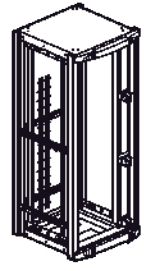
configure your LCS<sup>2</sup> system (continued)

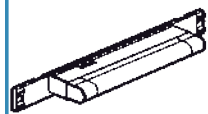
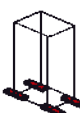
CABLE ENTRIES FOR LCS <sup>2</sup> 19" CABINETS AND SERVER CABINETS (p. 701)			
	Plastic plate with brushes, snap on	1 U	0 465 28
		2 U	0 465 29
	Metal plate with brushes	1 U	0 465 30
		2 U	0 465 31
THERMAL MANAGEMENT FOR LCS <sup>2</sup> 19" CABINETS AND SERVER CABINETS (p. 701)			
	19" 3 U plate with 230 V ~ fans	2 fans	0 464 87
		3 fans	0 464 88
	1 U ventilation drawer	2 fans, depth 150 mm	0 464 89
		4 fans, depth 300 mm	0 464 90
	Thermostat	Adjustable from 5 to 60°C	0 348 48
CABLE MANAGEMENT FOR LCS <sup>2</sup> 19" CABINETS AND SERVER CABINETS (p. 701-702)			
	Set of 3 cable management supports	For cabinet width/depth 600 mm	0 464 72
		For cabinet width/depth 800 mm	0 464 73
		For cabinet depth 1000 mm	0 464 74
	Flat cable guide	For 33 U cabinet	0 464 76
		For 42 U cabinet	0 464 77
	U-shaped cable guide, 3 m	Width 200 mm	0 464 69
		Width 400 mm	0 464 70
	Vertical cable management grille	For 42 U cabinet, width 800 mm	0 331 35
	Vertical cable manager	For 42 U cabinet, width 800 mm	0 464 80
	Patch extension	For 42 U cabinet, width 800 mm	0 464 81
	19" management panels, 2 axes	1 U	0 465 22
		2 U	0 465 23
ACCESSORIES FOR LCS <sup>2</sup> 19" CABINETS AND SERVER CABINETS (p. 701-702)			
	Accessories	230 V~ lighting kit, 1 U	0 464 85
		Anti-tilt kit	0 464 84
		Floor fixing kit	0 464 86
		Set of 4 casters - 380 kg max.	0 464 83
	Vertical PDU supports	For 42 U cabinets	0 465 75
		For 47 U cabinets	0 465 76

## Selection chart for equipment and cabinets

configure your LCS<sup>2</sup> system (continued)

LCS <sup>2</sup> 19" FREESTANDING CABINETS AND EQUIPMENT (p. 704)			FIXED		PIVOTING	
			Depth 400 mm	Depth 580 mm	Depth 600 mm	
	6 U	Height 350 mm x width 600 mm	0 462 00	-	-	
	9 U	Height 500 mm x width 600 mm	0 462 01	0 462 06	0 462 11	
	12 U	Height 600 mm x width 600 mm	0 462 02	0 462 07	0 462 12	
	16 U	Height 800 mm x width 600 mm	0 462 03	0 462 08	0 462 13	
	21 U	Height 1000 mm x width 600 mm	-	0 462 09	0 462 14	
	Fixed shelves	Depth 115 mm		0 465 00	0 465 00	0 465 00
		Depth 200 mm		0 465 01	0 465 01	0 465 01
		Depth 360 mm		-	0 465 02	0 465 02
	Equipment	Cable entry plate with brush		-	-	0 462 55
		Cable management ring		0 465 41 <sup>(1)</sup>	0 465 41/42	-
		230 V ~ fan		0 462 60	0 462 60	0 462 60
Thermostat			0 348 48	0 348 48	0 348 48	
Set of 4 casters			-	-	0 462 64	
<b>19" POWER DISTRIBUTION UNITS (PDUs) (p. 706)</b>						
	PDU 2P+E	9 x 2P+E sockets	French standard	0 465 50		
			German standard	0 465 60		
		12 x C13 sockets		0 465 51		
		9 x C19 sockets		0 465 52		
		6 x 2P+E sockets	French standard	0 465 54		
			German standard	0 465 62		
		6 x 2P+E sockets Switch with indicator	French standard	0 332 88		
		6 x 2P+E sockets Circuit breaker	French standard	0 332 37		
			German standard	0 332 38		
		6 x 2P+E sockets Tamperproof (UPS)	French standard	0 332 87		
		5 x 2P+E sockets	British standard	6 339 00		
		6 x 2P+E sockets	British standard	0 465 65		
		PDU with surge protector	6 x 2P+E sockets French standard	0 332 78		
PDU to be equipped	Takes 16 Mosaic modules	0 332 79				
Multiapplication 19" rail DIN kit	Rail DIN kit with front cover	0 465 46				
	Rear cover	0 465 47				
<b>VERTICAL POWER DISTRIBUTION UNITS (PDUs) (p. 706)</b>						
	PDU 2P+E	24 x 2P+E sockets	French standard	0 465 80 <sup>(2)</sup>		
			German standard	0 465 88 <sup>(2)</sup>		
			British standard	0 465 89 <sup>(2)</sup>		
		24 x C13 sockets		0 465 81 <sup>(2)</sup>		
		16 x C13 + 6 x C19 sockets Cord with IEC 60309 plug - 16 A		0 465 84 <sup>(2)</sup>		
24 x C13 + 3 x C19 sockets Cord with IEC 60309 plug - 32 A 3-phase supply		0 465 85 <sup>(2)</sup>				

1: Except for 6 U cabinet

2: Mounting in LCS<sup>2</sup> cabling and server cabinet with mounting bracket Cat.Nos 0 465 75/76

Metered PDUs  
p. 707

LCS<sup>2</sup> 10" wall-mounting cabinets  
p. 705





# Your LCS<sup>2</sup> cabinet in a few clicks

The new LCS Pro<sup>2</sup> software lets you quickly and easily select your products, view your cabinet, and more

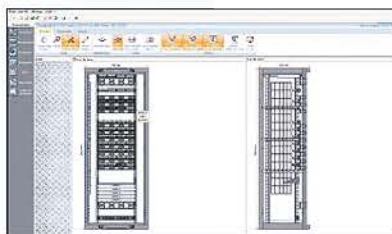
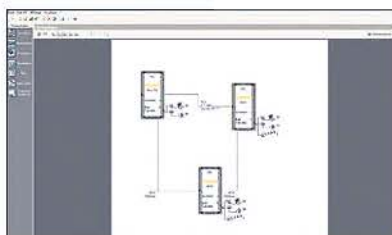

- Make the synoptic of your installation
- Find automatically Cat.Nos by selecting characteristic options
- Visualise the cabinet installation and amend it if required
- Manage your studies: technical summaries, purchase orders, document printing



0 335 86



0 335 90



0 335 76



Connector cat. 6A shielded STP

Pack	Cat.Nos	
		<b>Patch panel cat. 6A 24 x RJ 45 connectors</b>
		Panel supplied with quick-fixing Panel ensures automatic grounding of each connector Fitted with rear cable guide to hold cables during maintenance Fitted with 4 units of 6 LCS <sup>2</sup> RJ 45 connectors cat. 6A with fast connection thanks to integrated crimping, with wiring schemes T 568 A and T 568 B Supplied with numbered colour labels Conform to standards ISO/IEC 11801 Ed. 2.0, amendment 2, EN 50173-2 and TIA/EIA 568C 19" panel - 1 U
1	0 335 84	UTP panel - 8 contacts
1	0 335 85	UTP high density panel - 8 contacts
1	0 335 73	STP - Metal shielding 360°
1	0 335 86	STP high density panel - 360° metal shielding
		<b>Modular panel</b>
		Panel supplied with quick-fixing Panel ensures automatic grounding of each connector Fitted with rear cable guide to hold cables during maintenance Modular empty panel for up to 4 units Take the following equipment: - units of 6 x LCS <sup>2</sup> RJ 45 connectors - telephone inlet units - fibre optic units - PoE injector units - video streaming units - switch units - telephone/Ethernet doubler units - copper/fibre optic converter units - blanking plates
1	0 335 90	19" panel - 1 U
		<b>Units of 6 x RJ 45 connectors cat. 6A</b>
		Fitted with 6 x LCS <sup>2</sup> RJ 45 connectors cat. 6A with fast connection thanks to integrated crimping, with wiring schemes T 568 A and T 568 B Supplied with colour labels Conform to standards ISO/IEC 11801 Ed. 2.0, amendment 2, EN 50173-2 and TIA/EIA 568C
2	0 335 77	UTP unit - 8 contacts
2	0 335 76	STP unit - metal shielding 360°
10	0 335 91	Blanking plate for 19" panel - Black

# Legrand cabling system LCS<sup>2</sup> category 6A

## cables and cords



0 327 77



0 517 82

Pack	Cat.Nos	Cables for local networks cat. 6A
500 <sup>1</sup>	0 327 87	<p>Cables 4 pairs or 2 x 4 twisted pairs 100 ohms                      LSZH sleeve: halogen-free                      Yellow RAL 1018                      Colour code TIA/EIA                      Conform to standards ISO/IEC 11801                      Ed. 2.0, EN 50173-1 and TIA/EIA 568C                      Performance 500 MHz</p> <p><b>U/UTP - 4 pairs</b>                      Performance 500 MHz                      Length 500 m                      Supplied on reel. Weight 25 kg</p>
500 <sup>1</sup>	0 327 78	<p><b>F/UTP - 4 pairs</b>                      Performance 500 MHz                      Length 500 m                      Supplied on reel. Weight 25 kg</p>
500 <sup>1</sup>	0 328 78	<p><b>F/UTP - 2 x 4 pairs</b>                      Performance 500 MHz                      Length 500 m                      Supplied on reel. Weight 65 kg</p>
500 <sup>1</sup>	0 327 77	<p><b>S/FTP - 4 pairs</b>                      Performance 600 MHz                      Length 500 m                      Supplied on reel. Weight 30 kg</p>

1: in metre(s)

Pack	Cat.Nos	RJ 45 patch cords and user cords cat. 6A
1	0 518 82	<p>RJ 45 - RJ 45 right                      Conform to standards ISO/IEC 11801                      Ed. 2.0, EN 50173-1 and TIA/EIA 568C</p> <p><b>U/UTP unscreened impedance 100 Ω</b>                      Length 1 m</p>
1	0 518 83	<p>Length 2 m</p>
1	0 518 84	<p>Length 3 m</p>
1	0 518 85	<p>Length 5 m</p>
1	0 518 78	<p><b>U/UTP unscreened impedance 100 Ω</b>                      Length 1 m</p>
1	0 518 79	<p>Length 2 m</p>
1	0 518 80	<p>Length 3 m</p>
1	0 518 81	<p>Length 5 m</p>
1	0 518 74	<p><b>U/UTP unscreened impedance 100 Ω</b>                      Length 1 m</p>
1	0 518 75	<p>Length 2 m</p>
1	0 518 76	<p>Length 3 m</p>
1	0 518 77	<p>Length 5 m</p>
5	0 517 80	<p><b>S/FTP shielded impedance 100 Ω</b>                      Length 1 m</p>
5	0 517 81	<p>Length 2 m</p>
5	0 517 82	<p>Length 3 m</p>
5	0 517 83	<p>Length 5 m</p>
1	0 518 70	<p><b>S/FTP shielded impedance 100 Ω</b>                      Length 1 m</p>
1	0 518 71	<p>Length 2 m</p>
1	0 518 72	<p>Length 3 m</p>
1	0 518 73	<p>Length 5 m</p>
1	0 518 66	<p><b>S/FTP shielded impedance 100 Ω</b>                      Length 1 m</p>
1	0 518 67	<p>Length 2 m</p>
1	0 518 68	<p>Length 3 m</p>
1	0 518 69	<p>Length 5 m</p>

# Legrand cabling system LCS<sup>2</sup> category 6A

## RJ 45 sockets - Mosaic™ Programme



Can be integrated in all supports (p. 768 to 781)

Mechanisms to be equipped with support frames (p. 808) and plates (p. 806-807)

With LCS<sup>2</sup> connector with fast connection thanks to integrated crimping take AWG 22 single-core cables up to AWG 26 and AWG multicore cables

Contacts marked with dual colour code and wiring schemes T568 A and T 568 B

Conform to standards ISO/IEC 11801 Ed. 2.0, amendment 2, EN 50173-1 and TIA/EIA 568 C

Pack	Cat.Nos	Mosaic Programme RJ 45 sockets cat. 6A	Pack	Cat.Nos	Keystone RJ 45 sockets cat. 6A
		<b>STP - 1 module</b> 360° metal shielding	10	0 331 54	STP socket - metal shielding 360° with fast connection thanks to integrated crimping
10	0 765 73	○ White	10	0 331 55	UTP socket - with fast connection thanks to integrated crimping
10	0 765 84	○ White antimicrobial			
10	0 794 73	○ Aluminium			
		<b>STP - 2 modules</b> 360° metal shielding			<b>Surface-mounting 1 or 2 ports box</b>
10	0 765 76	○ White	20	6 327 79	For keystone connectors
10	0 794 76	○ Aluminium			Provides a solution for the integration of a keystone in surface-mounting installations
					Can be fixed on table or in association with mini-trunking
10	0 765 24	○ White with green shutter			
10	0 765 25	○ White with orange shutter			
10	0 765 08	○ White			
		<b>STP with controlled access - 2 modules</b> 360° metal shielding Supplied with 2 keys for 5 sockets			
5	0 765 99	○ White with red shutter			
		<b>UTP - 1 module</b>			
10	0 765 71	○ White			
10	0 794 71	○ Aluminium			
10	0 765 26	○ White with green shutter			
10	0 765 27	○ White with orange shutter			
		<b>UTP - 2 modules</b>			
10	0 765 74	○ White			
10	0 794 74	○ Aluminium			
		<b>UTP with controlled access - 2 modules</b> Supplied with 2 keys for 5 sockets			
5	0 765 90	○ White with red shutter			
10	0 765 09	○ White			



Area distribution boxes p. 676





# Legrand cabling system LCS<sup>2</sup> category 6A

RJ 45 sockets - Arteor

## AUDIO/VIDEO SOCKETS

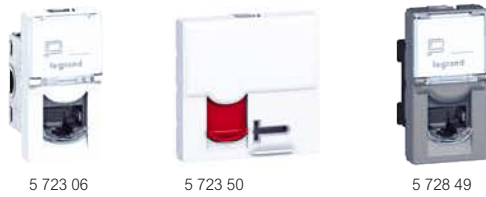

Mechanisms supplied with square rocker plates, to be equipped with support frames (p. 384-385) and plates (p.358-359 and 386 to 391) Can be integrated in all supports (p. 768 to 780)  
 With LCS<sup>2</sup> connector with fast connection thanks to integrated crimping take AWG 22 single-core cables up to AWG 26 and AWG multicore cables  
 Contacts marked with dual colour code and wiring schemes T568 A and T 568 B  
 Conform to standards ISO/IEC 11801 Ed. 2.0, amendment 2, EN 50173-1 and TIA/EIA 568 C

Pack	Cat.Nos	Arteor RJ 45 sockets cat. 6A
		360° metal shielding
		<b>STP - 1 module</b>
10	5 723 06	○ White
10	5 728 06	● Magnesium
10	5 723 51	○ White with orange shutter
10	5 728 51	● Magnesium with orange shutter,
10	5 723 52	○ White with green shutter
10	5 728 52	● Magnesium with green shutter
		<b>STP with controlled access - 2 modules</b>
		Supplied with 2 keys for 5 sockets
5	5 723 50	○ White with red shutter
5	5 728 50	● Magnesium with red shutter
		<b>UTP - 1 module</b>
10	5 723 49	○ White
10	5 728 49	● Magnesium
10	5 723 59	○ White with green shutter
10	5 728 59	● Magnesium with green shutter
10	5 723 58	○ White with orange shutter
10	5 728 58	● Magnesium with orange shutter
		<b>UTP with controlled access - 2 modules</b>
		Supplied with 2 keys for 5 sockets
5	5 723 57	○ White with red shutter
5	5 728 57	● Magnesium with red shutter

The  
**right system**  
 to meet  
 your **needs**

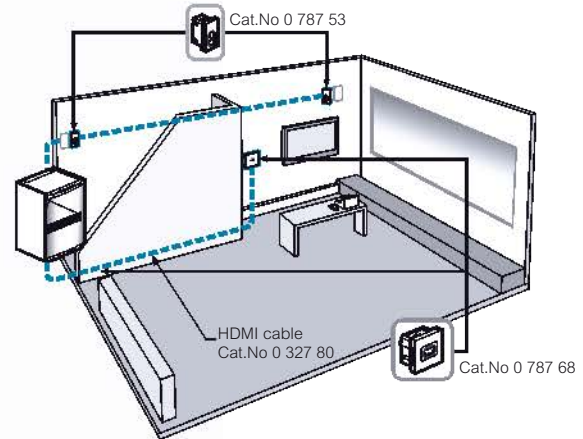

■ Audio/video sockets, p. 694-695

### From the cabinets to the terminal sockets

- 19" LCS<sup>2</sup> cabinets
- 19" patch panels: to distribute the audio/video signal
- cords: for connecting a socket to a terminal
- cables: for connecting 2 sockets a long distance apart
- sockets: choose between 20 technologies

# Legrand cabling system LCS<sup>2</sup> category 6

patch panels, blocks of connectors



0 335 62



0 335 89



0 335 90



0 335 65



Cat. 6 connector  
STP shielded

Pack	Cat.Nos	<b>Patch panels cat. 6 24 x RJ 45 quick-fixing connectors</b>
		<b>Patch panels</b> Panels supplied with quick-fixing Panels ensure automatic grounding of each connector Fitted with rear cable guide to hold cables during maintenance Fitted with 4 units of 6 LCS <sup>2</sup> RJ 45 connectors cat. 6 with fast connection thanks to integrated crimping, with colour code and wiring schemes T 568 A and T 568 B Supplied with numbered colour labels Conform to standards ISO/IEC 11801 Ed. 2.0, amendment 2, EN 50173-2 and TIA/EIA 568C 19" panel - 1 U
1	0 335 61	UTP panel - 8 contacts
1	0 335 67	UTP high density panel - 8 contacts
1	0 335 62	FTP panel - 9 contacts
1	0 335 68	FTP high density panel - 9 contacts
1	0 335 63	STP panel - metal shielding 360°
		<b>UTP through panel</b> 24 x RJ 45 connectors
1	0 335 89	UTP through panel

Pack	Cat.Nos	<b>Modular panels</b>
		Panels supplied with quick-fixing General all-purpose assembly of all enclosures or cabinets Panels ensure automatic earthing of each connector Fitted with rear cable guide to hold cables during maintenance Empty panels to be fitted with 4 units Take the following equipment: - 6 LCS <sup>2</sup> RJ 45 connector units - telephone inlet units - fibre optic units - PoE injector units - video streaming units - switch units - telephone/Ethernet doubler units - copper/fibre optic converter units - blanking plates
1	0 335 90	19" panel - 1 U
		<b>Units of 6 x RJ 45 connectors cat. 6</b> Fitted with 6 x LCS <sup>2</sup> RJ 45 connectors cat. 6 with fast connection thanks to integrated crimping, with colour code and wiring schemes T 568 A and T 568 B Supplied with colour labels Conform to standards ISO/IEC 11801 Ed. 2.0, EN 50173-1 and TIA/EIA 568
2	0 335 64	UTP unit - 8 contacts
2	0 335 65	FTP unit - 9 contacts
2	0 335 66	STP unit - metal shielding 360°
10	0 335 91	Blanking plate for 19" panel - Black

# Legrand cabling system LCS<sup>2</sup> category 6

## cables and cords

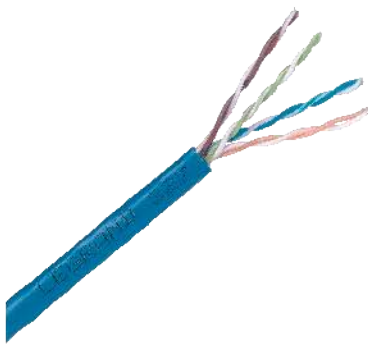

0 327 54

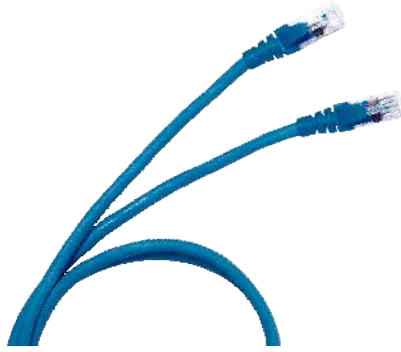

0 517 62

Pack	Cat.Nos	Cables for local networks cat. 6
		Cables 4 pairs or 2 x 4 twisted pairs 100 ohms Blue RAL 5015 Colour code TIA/EIA Conform to standards ISO/IEC 11801 Ed. 2.0, EN 50173-1 and TIA/EIA 568C
305 <sup>1</sup>	0 327 54	<b>U/UTP - 4 pairs</b> Length 305 m Supplied in cardboard box. Weight 16 kg
500 <sup>1</sup>	0 328 61	<b>U/UTP - 4 pairs</b> Length 500 m Supplied on reel. Weight 18 kg
305 <sup>1</sup>	0 327 55	<b>U/UTP - 2 x 4 pairs</b> Length 305m Supplied in cardboard box. Weight 13 kg
500 <sup>1</sup>	0 328 63	<b>U/UTP - 2 x 4 pairs</b> Length 500 m Supplied in cardboard box. Weight 38 kg
305 <sup>1</sup>	0 328 56	<b>F/UTP - 4 pairs</b> Length 305 m Supplied on reel. Weight 17 kg
500 <sup>1</sup>	0 327 56	<b>F/UTP - 4 pairs</b> Length 500 m Supplied on reel. Weight 25 kg
305 <sup>1</sup>	0 328 57	<b>F/UTP - 4 pairs</b> Length 305 m Supplied in cardboard box. Weight 17 kg
500 <sup>1</sup>	0 327 58	<b>F/UTP - 4 pairs</b> Length 500 m Supplied on reel. Weight 25 kg
500 <sup>1</sup>	0 327 76	<b>F/UTP - 2 x 4 pairs</b> Length 500 m Supplied on reel. Weight 48 kg
500 <sup>1</sup>	0 327 57	<b>SF/UTP - 4 pairs</b> Length 500 m Supplied on reel. Weight 29 kg
500 <sup>1</sup>	0 327 59	<b>SF/UTP - 4 pairs</b> Length 500 m Supplied on reel. Weight 30 kg
500 <sup>1</sup>	0 328 59	<b>SF/UTP - 2 x 4 pairs</b> Length 500 m Supplied on reel. Weight 52 kg

1: in meter(s)

Pack	Cat.Nos	RJ 45 patch cords and user cords cat. 6
		RJ 45 - RJ 45 right <b>U/UTP unscreened impedance 100 Ω</b>
1	0 517 72	Length 1 m
1	0 517 73	Length 2 m
1	0 517 74	Length 3 m
1	0 517 75	Length 5 m
		<b>F/UTP screened impedance 100 Ω</b>
1	0 518 62	Length 1 m
1	0 518 63	Length 2 m
1	0 518 64	Length 3 m
1	0 518 65	Length 5 m
		<b>SF/UTP shielded impedance 100 Ω</b>
5	0 517 52	Length 1 m
5	0 517 53	Length 2 m
5	0 517 54	Length 3 m
5	0 517 55	Length 5 m

# Legrand cabling system LCS<sup>2</sup> category 6

## RJ 45 sockets - Mosaic™ Programme



Can be integrated in all supports (p. 768 to 781)  
 Mechanisms to be equipped with support frames (p. 808) and plates (p. 806-807)  
 With LCS<sup>2</sup> connector with fast connection thanks to integrated crimping take AWG 22 single-core cables up to AWG 26 and AWG multicore cables  
 Contacts marked with dual colour code and wiring schemes T568 A and T 568 B  
 Conform to standards ISO/IEC 11801 Ed. 2.0, amendment 2, EN 50173-1 and TIA/EIA 568 C

Pack	Cat.Nos	Mosaic Programme RJ 45 sockets cat. 6	Pack	Cat.Nos	Mosaic Programme RJ 45 sockets cat. 6 (continued)
10	0 765 61	<b>UTP - 1 module</b> ○ White	5	0 765 95	<b>FTP with controlled access - 2 modules</b> Supplied with 2 keys for 5 sockets ○ White with red shutter
10	0 794 61	● Aluminium	10	0 765 05	<b>FTP 45° - 2 modules</b> ○ White
10	0 786 06	○ White, connection with 110 tool	5	0 765 06	<b>FTP 2 x RJ 45 45° - 2 modules</b> ○ White
10	0 794 12	● Aluminium, connection with 110 tool	1	0 765 33	<b>FTP retractable RJ 45 sockets - 4 modules</b> With integrated retractable cord (0.9 m) Winds up automatically with a pushbutton ○ White ● Aluminium
10	0 765 81	○ White antimicrobial	1	0 794 33	
10	0 765 64	<b>UTP - 2 modules</b> ○ White	10	0 765 92	<b>FTP 90° - 2 modules</b> Vertical snap-on socket for column module ○ White
10	0 794 64	● Aluminium	10	0 794 92	
10	0 786 07	○ White, connection with 110 tool	10	0 765 92	<b>Shielded STP - 1 module</b> ○ White ○ White antimicrobial
10	0 794 13	● Aluminium, connection with 110 tool	10	0 794 92	
5	0 765 94	<b>UTP with controlled access - 2 modules</b> Supplied with 2 keys for 5 sockets ○ White with red shutter	10	0 765 63	<b>Shielded STP - 2 modules</b> ○ White
10	0 765 91	<b>UTP 90° - 2 modules</b> Vertical snap-on socket for column module ○ White	10	0 765 83	
10	0 765 03	○ White	10	0 794 86	<b>STP - 2 modules</b> ● Black
10	0 765 14	○ White, connection with 110 tool	5	0 765 96	<b>Shielded STP with controlled access - 2 modules</b> Supplied with 2 keys for 5 sockets ○ White with red shutter
5	0 765 04	<b>UTP 45° - 2 x RJ 45 - 2 modules</b> ○ White	10	0 765 07	<b>STP 45° - 2 modules</b> Vertical snap-on socket for column module ○ White
1	0 765 32	<b>UTP retractable RJ 45 socket - 4 modules</b> With integrated retractable cord (0.9 m) Winds up automatically with a pushbutton ○ White	10	0 765 93	<b>Shielded STP 90° - 2 modules</b> Vertical snap-on socket for column module ○ White
10	0 794 81	<b>UTP - 1 module</b> ● Black			
5	0 765 44	<b>UTP 2 x RJ 45 with Soluclip accessory - 3 modules</b> For snap-on mounting on DLP trunking with 45 mm cover ○ White			
10	0 765 62	○ White			
10	0 794 62	● Aluminium			
10	0 765 82	○ White antimicrobial			
10	0 765 65	○ White			
10	0 794 65	● Aluminium			
10	0 765 22	○ White with green shutter			
10	0 765 23	○ White with orange shutter			
5	0 765 46	<b>FTP - 2 modules</b> For snap-on mounting on trunking with 45 mm cover ○ White			
10	0 794 85	● Black			

Sockets for snap-on trunking  
 Black edition p. 744



# Legrand cabling system LCS<sup>2</sup> category 6

## RJ 45 sockets - Arteur, Soliroc and Plexo



Can be integrated in all supports (p. 768 to 781)  
 With LCS<sup>2</sup> connector with fast connection thanks to integrated crimping take AWG 22 single-core cables up to AWG 26 and AWG multicore cables  
 Contacts marked with dual colour code and wiring schemes T568 A and T 568 B  
 Conform to standards ISO/IEC 11801 Ed. 2.0, amendment 2, EN 50173-1 and TIA/EIA 568 C

Pack	Cat.Nos	Arteur RJ 45 sockets cat. 6
		Mechanisms supplied with square rocker plates, to be equipped with support frames (p. 384-385) and plates (p. 358-359 and 386 to 391)
10	5 723 02	<b>UTP - 1 module</b> ○ White
10	5 728 02	● Magnesium
10	5 723 54	○ White with orange shutter
10	5 728 54	● Magnesium with orange shutter
10	5 723 55	○ White with green shutter
10	5 728 55	● Magnesium with green shutter
10	5 723 14	<b>UTP - 2 modules</b> ○ White - square version
10	5 728 14	● Magnesium - square version
		<b>UTP with controlled access - 2 modules</b> Supplied with 2 keys for 5 sockets
5	5 723 53	○ White with red shutter
5	5 728 53	● Magnesium with red shutter
		<b>UTP retractable RJ 45 sockets - 4 modules</b> With integrated retractable cord (0.9 m) Winds up automatically with a pushbutton
1	5 723 39	○ White
1	5 728 39	● Magnesium
10	5 723 22	<b>FTP - 1 module</b> ○ White
10	5 728 22	● Magnesium
10	5 723 16	<b>FTP - 2 modules</b> ○ White
10	5 728 16	● Magnesium
10	5 723 23	<b>Shielded STP - 1 module</b> ○ White
10	5 728 23	● Magnesium
10	5 723 17	<b>Shielded STP - 2 modules</b> ○ White
10	5 728 17	● Magnesium

Pack	Cat.Nos	Keystone RJ 45 socket cat. 6
10	0 331 81	UTP socket with fast connection
20	6 327 79	<b>Surface-mounting 1 or 2 ports box</b> For keystone connectors Provides a solution for the integration of a keystone in surface-mounting installations Can be fixed on table or in association with mini-trunking
1	0 778 91	<b>Soliroc RJ 45 socket cat. 6 - IK 10</b> <b>FTP - 2 modules</b> IP 20 - IK 10 For at-risk areas or areas with no surveillance
5	0 695 69	<b>Plexo RJ 45 sockets cat. 6 - IP 55 closed flap IK 07</b> <b>RJ 45 sockets</b> Protection against water, dust For industrial sites
1	0 695 61	○ Grey/white FTP socket
1	0 695 81	○ Grey/white UTP socket
1	0 695 81	<b>Adaptor for RJ 45 socket</b> RJ 45 to be ordered separately Weatherproofing ensured (IP 44) plug inserted ○ Grey/white
1	0 904 67	<b>Plexo 66 RJ 45 socket cat. 6 - IP 66 - IK 08</b> <b>FTP socket</b> 9 contacts Weatherproofing ensured (IP 66) with plug inserted Inclined 90° ● Grey RAL 7016/T029

Arteur and Mosaic Programme audio/video sockets p. 694-695



# Legrand cabling system LCS<sup>2</sup> category 6A and 6

## area distribution boxes and cords



0 335 49



0 335 40



0 335 40 fitted with SC fibre optic unit, accessory Cat.No 0 335 20 and a 6 x RJ 45 connector unit

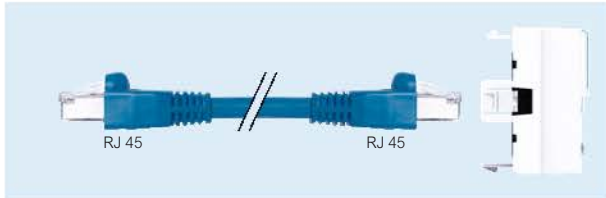

Connection principle



0 517 86



0 517 57



0 515 23

Pack	Cat.Nos	Area distribution boxes
		<p>For distribution of low current in a zone fitted with 1 to 12 RJ 45 sockets                      Centralise connections to guarantee flexibility and adaptability of the installation                      Installed on false ceiling or false floor                      Connect to the patch panel or the floor cabinet                      Connection to an RJ 45 socket with stripped cord or to a Mosaic RJ 45 socket with copper feedthrough with an RJ 45/RJ 45 cord                      IP 21 - IK 07                      Conform to standards UTE C 15-900, NF C 15-100, NF C 20-730, EN 50-174.2, CEI 60950, ISO/IEC 11801 Ed. 2.0, EN 50173-2 and TIA/EIA 568 Colour code TIA/EIA 568 A and C                      Cords and cables: ISO 11801 Ed.2.0, EN 50173-1, TIA/EIA 568                      Technical characteristics:                      - polycarbonate PC hood                      - polypropylene PP base                      - RAL 7035                      - hold connector units in place in the box: 100 N                      - Cables anchored on support using Colring cable ties</p>
1	0 335 49	<p><b>Area distribution boxes cat. 6A</b>                      STP                      Fitted with 2 x 6 LCS<sup>2</sup> RJ 45 cat. 6A connector blocks and RJ 45 blanking plates                      Supplied with Colring cable ties</p> <p><b>Area distribution boxes cat. 6</b>                      Fitted with 2 x 6 LCS<sup>2</sup> connector blocks                      RJ 45 cat. 6 and RJ 45 blanking plates                      Supplied with Colring cable ties</p>
1	0 335 44	UTP
1	0 335 45	FTP
1	0 335 46	STP
1	0 335 40	<p><b>Self-assembly area distribution box for cat. 6A, 6 and 5e</b>                      Used for mounting LCS<sup>2</sup> RJ 45 connector blocks cat. 6A (p. 668), RJ 45 connector blocks cat. 6 (p. 672) or RJ 45 connector blocks cat. 5e (p. 679)</p>
		<p><b>Cords cat. 6A - RJ 45/stripped</b>                      RJ 45 - straight stripped                      Clip on and off in the area distribution boxes and connection via LCS<sup>2</sup> connector of an RJ 45 socket by the stripped side                      Cords prepared in factory, "ready for wiring"                      Conform to standards ISO/IEC 11801 Ed. 2.0, EN 50173-1 and TIA/EIA 568 C2                      Yellow RAL 1018</p> <p><b>S/FTP unscreened impedance 100 Ω</b>                      Length 8 m                      Length 15 m                      Length 20 m</p>
1	0 517 86	Length 8 m
1	0 517 87	Length 15 m
1	0 517 88	Length 20 m

Pack	Cat.Nos	Cords cat. 6 - RJ 45/stripped AWG 24
		<p>RJ 45 - straight stripped                      Clip on and off in the area distribution boxes and connection via LCS<sup>2</sup> connector of an RJ 45 socket by the stripped side                      Cords prepared in factory, "ready for wiring"                      Conform to standards ISO/IEC 11801 Ed. 2.0, EN 50173-1 and TIA/EIA 568                      Blue RAL 5015                      Wiring in T 568 B</p> <p><b>U/UTP unscreened impedance 100 Ω</b>                      Length 8 m                      Length 15 m                      Length 20 m</p> <p><b>F/UTP screened impedance 100 Ω</b>                      Length 8 m                      Length 15 m                      Length 20 m</p>
4	0 517 57	Length 8 m
4	0 517 58	Length 15 m
4	0 517 59	Length 20 m
		<p><b>Cords cat. 6A - RJ 45/RJ 45</b>                      For direct connection via RJ 45 male plug to the area distribution box and to the RJ 45 socket with copper feedthrough to ensure:                      - safe connection                      - speed and reliability of connection                      Yellow RAL 1018</p> <p><b>S/FTP unscreened impedance 100 Ω</b>                      Length 8 m                      Length 15 m                      Length 20 m</p>
4	0 515 23	Length 8 m
4	0 515 24	Length 15 m
4	0 515 25	Length 20 m
		<p><b>Cords cat. 6 - RJ 45/RJ 45</b>                      For direct connection via RJ 45 male plug to the zone distribution box and to the RJ 45 socket with copper feedthrough to ensure:                      - safe connection                      - speed and reliability of connection                      Blue RAL 5015</p> <p><b>U/UTP unscreened impedance 100 Ω</b>                      Length 8 m                      Length 15 m                      Length 20 m</p> <p><b>F/UTP screened impedance 100 Ω</b>                      Length 8 m                      Length 15 m                      Length 20 m</p>
4	0 515 10	Length 8 m
4	0 515 11	Length 15 m
4	0 515 12	Length 20 m
4	0 515 13	Length 8 m
4	0 515 14	Length 15 m
4	0 515 15	Length 20 m

## Legrand cabling system LCS<sup>2</sup> category 5e cords

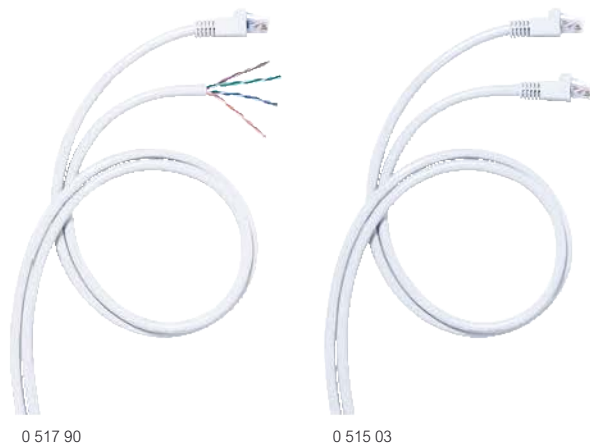

Pack	Cat.Nos	Cords cat. 5e - RJ 45/stripped
		RJ 45 - straight stripped Clip on and off in the area distribution boxes and RJ 45 socket connection via LCS <sup>2</sup> connector via the stripped side Cords prepared in factory, "ready for wiring" Conform to standards ISO/IEC 11801 Ed. 2.0, EN 50173-1 and TIA/EIA 568 Grey RAL 7035 Wiring in T 568 B
4	0 517 90	<b>U/UTP unscreened impedance 100 Ω</b> Length 8 m
4	0 517 91	Length 15 m
4	0 517 92	Length 20 m
4	0 517 93	<b>F/UTP screened impedance 100 Ω</b> Length 8 m
4	0 517 94	Length 15 m
4	0 517 95	Length 20 m
		<b>Cords cat. 5e - RJ 45/RJ 45</b> For direct connection via RJ 45 male plug to the zone distribution box and to the RJ 45 socket with copper feedthrough to ensure: - safe connection - speed and reliability of connection Grey RAL 7035
4	0 515 00	<b>U/UTP unscreened impedance 100 Ω</b> Length 8 m
4	0 515 01	Length 15 m
4	0 515 02	Length 20 m
4	0 515 03	<b>F/UTP unscreened impedance 100 Ω</b> Length 8 m
4	0 515 04	Length 15 m
4	0 515 05	Length 20 m

## Legrand cabling system LCS<sup>2</sup> category 6A, 6 and 5e - feedthrough sockets - Mosaic™ Programme and Arteor



Certified as conforming to standards ISO 11801 ed. 2.0, EN 50173-1 and EIA/TIA 568  
Contacts marked with 568 A and B dual colour code and numbers  
Connectors with self-stripping terminals  
Possibility of re-wiring in the event of error  
Multidirectional cable entry  
For use with area distribution boxes (see opposite), connection to boxes via RJ 45-RJ 45 dedicated cords  
Used to create cat. 6A, cat. 6 and cat. 5e links in accordance with standards  
2 modules

Pack	Cat.Nos	Sockets with copper feedthrough cat. 6A
10	0 786 28	<b>Cat. 6A STP - Mosaic Programme</b> ○ White
10	0 786 29	● Aluminium
10	0 786 22	<b>Sockets with copper feedthrough cat. 6</b> <b>Cat. 6 UTP - Mosaic Programme</b> ○ White
10	0 786 26	● Aluminium
10	0 786 23	<b>Cat. 6 FTP - Mosaic Programme</b> ○ White
10	0 786 27	● Aluminium
10	5 723 31	<b>Cat. 6 UTP - Arteor</b> ○ White
10	5 728 31	● Magnesium
10	5 723 33	<b>Cat. 6 FTP - Arteor</b> ○ White
10	5 728 33	● Magnesium
10	0 786 20	<b>Sockets with copper feedthrough cat. 5e</b> <b>Cat. 5e UTP - Mosaic Programme</b> ○ White
10	0 786 24	● Aluminium
10	0 786 21	<b>Cat. 5e FTP - Mosaic Programme</b> ○ White
10	0 786 25	● Aluminium
10	5 723 30	<b>Cat. 5e UTP - Arteor</b> ○ White
10	5 728 30	● Magnesium
10	5 723 32	<b>Cat. 5e FTP - Arteor</b> ○ White
10	5 728 32	● Magnesium

# Legrand cabling system LCS<sup>2</sup> area distribution boxes

## ■ Dimensions

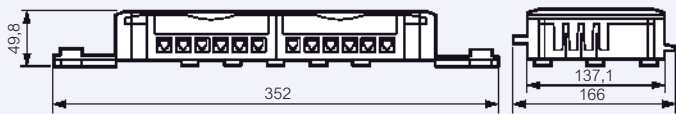

## ■ Performance

Maximum recommended lengths of links to ensure high performance of the systems with the use of RJ 45 sockets with copper feedthroughs and/or RJ 45 sockets

	Length associated lengths (m)		Links
	Cords	Cables	
Cat. 6A	8	70	78
	15	60	75
	20	55	75
Cat. 6	8	70	78
	15	60	75
	20	55	75
Cat. 5e	8	75	83
	15	65	80
	20	60	80

We recommend selecting the shortest wiring lengths for more flexibility regarding cord length in the event of reconfiguration

## ■ Application example



An area distribution box is installed to connect the RJ 45 sockets and meet the future requirements of the installation



Connection to additional RJ 45 sockets is done by adding RJ 45 - RJ 45 cords between the unit and the RJ 45 sockets with copper feedthrough



## Legrand cabling system LCS<sup>2</sup> category 5e patch panels, blocks of connectors



0 335 52

Pack	Cat.Nos	Patch panels cat. 5e 24 x RJ 45 connectors
		<p>Panels supplied with quick-fixing Panels ensure automatic grounding of each connector Fitted with rear cable guide to hold cables during maintenance Fitted with 4 units of 6 LCS<sup>2</sup> RJ 45 connectors cat 5e with fast connection thanks to integrated crimping, with colour code and wiring schemes T 568 A and T 568 B Supplied with colour labels numbered from 1 to 24 Conform to standards ISO/IEC 11801 Ed. 2.0, EN 50173-1 and TIA/EIA 568 19" panel - 1 U</p> <p><b>UTP panel</b></p> <p>1 0 335 51 UTP panel - 8 contacts 1 0 335 82 UTP panel - 8 contacts - connection with 110 tool 1 0 335 83 UTP high density panel - 8 contacts - connection with 110 tool</p> <p><b>FTP panel</b></p> <p>1 0 335 52 FTP panel - 9 contacts</p> <p><b>UTP through panel</b></p> <p>1 0 335 88 24 RJ 45 connectors UTP through panel</p>
		<p><b>Modular panels</b></p> <p>Panels supplied with fast assembly Panels ensure automatic grounding of each connector Fitted with rear cable guide to hold cables during maintenance Modular empty panels for up to 4 units Takes the following equipment: - units of 6 LCS<sup>2</sup> RJ 45 connectors - units for telephone inlets - fibre optic units - PoE injector units - video streaming units - switch units - telephone/Ethernet doubler units - copper/fibre optic converter units - blanking plates 1 0 335 90 19" panel - 1 U</p>
		<p><b>Units of 6 x RJ 45 connectors cat. 5e</b></p> <p>Fitted with 6 x LCS<sup>2</sup> RJ 45 connectors cat. 5e with fast connection thanks to integrated crimping, with colour code and wiring schemes T 568 A and T 568 B Supplied with colour labels Conforms to standards ISO/IEC 11801 Ed. 2.0, EN 50173-1 and TIA/EIA 568</p> <p>2 0 335 54 UTP unit 2 0 335 55 FTP unit 10 0 335 91 Blanking plate for 19" panel - Black</p>

## Legrand cabling system LCS<sup>2</sup> category 5e cables and cords

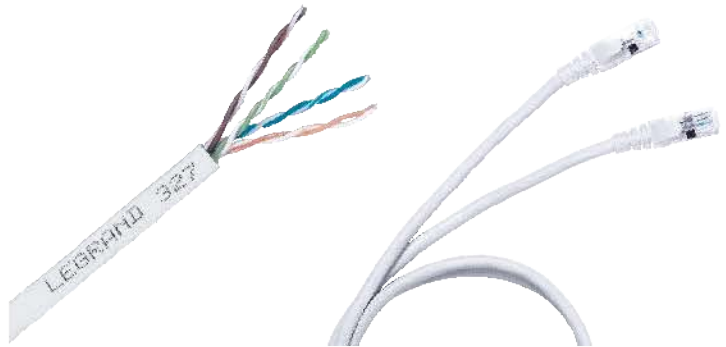

0 328 50

0 516 40

Pack	Cat.Nos	Cables for local networks cat. 5e
		<p>4 twisted pair cables 100 ohms LSZH sleeve: non-halogen Grey RAL 7035 Colour code TIA/EIA</p> <p><b>U/UTP - 4 pairs</b> Length 305m Supplied in cardboard box. Weight 10 kg Length 500 m Supplied on reel. Weight 15 kg</p> <p>305' 0 327 51 Length 305m Supplied in cardboard box. Weight 9 kg</p> <p><b>U/UTP - 2 x 4 pairs</b> Length 500 m Supplied on reel</p> <p><b>F/UTP - 4 pairs</b> Length 305 m Supplied in cardboard box. Weight 12 kg Length 500 m Supplied on reel. Weight 21 kg</p> <p>305' 0 327 53 Length 305 m Supplied by box. Weight 11 kg</p> <p><b>F/UTP - 2x4 pairs</b> Length 500 m Supplied on reel. Weight 38 kg</p>
		<p><b>RJ 45 patch cords and user cords cat. 5e</b></p> <p>RJ 45 - RJ 45 right</p> <p><b>U/UTP unshielded impedance 100 Ω</b> Grey Length 1m Length 2m Length 3m Length 5m</p> <p><b>F/UTP screened impedance 100 Ω</b> Grey Length 1 m Length 2 m Length 3 m Length 5 m</p>

1: in metre(s)

# Legrand cabling system LCS<sup>2</sup> category 5e

## RJ 45 sockets - Mosaic™ Programme, Arteor and Plexo



Can be integrated in all supports (p. 768 to 781)

With LCS<sup>2</sup> connector with fast connection thanks to integrated crimping Take AWG 22 single-core cables up to AWG 26 and AWG multicore cables  
Contacts marked with dual colour code and wiring schemes T568 A and T 568 B  
Conform to standards ISO/IEC 11801 Ed. 2.0, amendment 2, EN 50173-1 and TIA/EIA 568 C

Pack	Cat.Nos	Mosaic Programme RJ 45 sockets cat. 5e	Pack	Cat.Nos	Arteor RJ 45 sockets cat. 5e
		Mechanisms to be equipped with support frames (p. 808) and plates (p. 806-807)			Mechanisms supplied with square rocker plates, to be equipped with support frames (p. 384-385) and plates (p. 358-359 and 386 to 391)
10	0 765 51	<b>UTP - 1 module</b> ○ White	10	5 723 03	<b>UTP - 1 module</b> ○ White
10	0 794 51	● Aluminium	10	5 728 03	● Aluminium
10	0 765 54	<b>UTP - 2 modules</b> ○ White	10	5 723 15	<b>UTP - 2 modules</b> ○ White
10	0 794 54	● Aluminium	10	5 728 15	● Aluminium
10	0 765 18	○ White, connection with 110 tool	10	5 723 04	<b>FTP - 1 module</b> ○ White
5	0 765 97	<b>UTP with controlled access - 2 modules</b> Supplied with 2 keys for 5 sockets ○ White with red shutter	10	5 728 04	● Aluminium
5	0 765 41	<b>UTP - 2 x RJ 45 with Soluclip accessory - 3 modules</b> For snap-on mounting on DLP trunking with 45 mm cover ○ White			<b>Keystone RJ 45 socket cat. 5e</b> <b>UTP socket</b> With fast crimping connection
1	0 765 30	<b>UTP retractable RJ 45 socket - 4 modules</b> With integrated retractable cord (0.9 m) Winds up automatically with a pushbutton ○ White	20	6 327 79	<b>Surface-mounting 1 or 2 ports box</b> For keystone connectors Provides a solution for the integration of a keystone in surface-mounting installations Can be fixed on table or in association with mini-trunking
10	0 765 01	<b>UTP 45° - 2 modules</b> ○ White			<b>Plexo RJ 45 sockets, cat. 5e - IP 55 closed flap IK 07</b> <b>RJ 45 sockets</b> Protection against water, dust For industrial sites
5	0 765 02	<b>2 x RJ 45 UTP 45° - 2 modules</b> ○ White	1	0 695 57	○ Grey/White FTP socket
10	0 765 52	<b>FTP - 1 module</b> ○ White	1	0 695 56	○ Grey/White UTP socket
10	0 794 52	● Aluminium	1	0 695 81	<b>Adaptor for RJ 45 socket</b> RJ 45 to be ordered separately Weatherproofing ensured (IP 44) plug inserted ○ Grey/white
10	0 765 55	<b>FTP - 2 modules</b> ○ White			
10	0 794 55	● Aluminium			
5	0 765 98	<b>FTP with controlled access - 2 modules</b> Supplied with 2 keys for 5 sockets ○ White with red shutter			
5	0 765 42	<b>FTP - 2 x RJ 45 with Soluclip accessory - 3 modules</b> For snap-on mounting on Mosaic trunking with 45 mm cover ○ White			



# Legrand cabling system LCS<sup>2</sup> category 6A, 6 and 5e

## additional products and doublers



0 335 90



0 335 39



0 335 34



0 335 12



0 335 16



0 334 75

Pack	Cat.Nos	Modular panels
1	0 335 90	<p>Panels supplied with captive screws and cage nuts or with quick fixing</p> <p>Universal mounting for all enclosures or cabinets</p> <p>Panels ensure automatic earthing of each connector</p> <p>Fitted with rear cable guide to hold cables in place during maintenance</p> <p>Modular empty panels for up to 4 units</p> <p>Take the following equipment:</p> <ul style="list-style-type: none"> <li>- units of 6 x LCS<sup>2</sup> RJ 45 connectors</li> <li>- units for telephone inlets</li> <li>- fibre optic units</li> <li>- PoE injector units</li> <li>- video streaming units</li> <li>- switch units</li> <li>- telephone/Ethernet doubler units</li> <li>- copper/fibre optic converter units</li> <li>- blanking plates</li> </ul> <p>19" panel - 1 U</p>

Pack	Cat.Nos	Doubler units
2	0 335 54	UTP unit
2	0 335 55	FTP unit
10	0 335 91	Blanking plate for 19" panel - Black
1	0 335 39	<b>Ethernet/Ethernet doublers 100 base T</b>
1	0 335 38	FTP - 9 contacts
		UTP - 8 contacts
1	0 335 37	<b>Telephone/Ethernet doublers 100 base T</b>
1	0 335 36	FTP - 9 contacts
		UTP - 8 contacts
1	0 335 35	<b>Telephone/telephone doubler</b>
		45 contacts

Pack	Cat.Nos	Video streaming unit
1	0 335 34	Block of 6 "F" connectors for video circuits

Pack	Cat.Nos	Fibre optic units
		<p>Clip directly onto fibre optic drawer Cat.No 0 335 10 (p. 685), on the patch panels with fibre optic cassette Cat.No 0 335 11 (p. 685) or in the area distribution boxes with fibre optic accessory Cat.No 0 335 20 (p. 690)</p>
1	0 335 13	<b>Monomode fibre units (9/125 µm)</b>
1	0 335 12	LC unit for 6 monomode fibres
		SC unit for 6 monomode fibres
1	0 335 16	<b>Multimode fibre units (62.5 and 50/125 µm)</b>
1	0 335 17	ST unit for 6 multimode fibres
1	0 335 18	SC unit for 6 multimode fibres
1	0 335 19	LC unit for 6 multimode fibres
1	0 335 19	High-density LC unit for 12 multimode fibres

Pack	Cat.Nos	Access control units
		<p><b>Access control units</b></p> <p>Solution to secure a passive RJ 45 on sensitive networks</p> <p>Possibility to lock / unlock a cord with the unlocking tool Cat.No 0 334 70 (not supplied)</p> <p>Compatible with all Legrand LCS<sup>2</sup> 19" cat. 6A / 6 / 5e patch panels and cords</p>
2	0 334 71	Black shutter
2	0 334 72	Blue shutter
2	0 334 73	Red shutter
2	0 334 74	Orange shutter
2	0 334 75	Green shutter
5	0 334 70	<b>Unlocking tool for access control units</b>
		Unlocking tool

# Legrand cabling system LCS<sup>2</sup> category 6A, 6 and 5e

## additional products and doublers (continued)



0 335 02



0 335 01



0 327 37



0 539 49

Pack	Cat.Nos	Blanking plates
10	0 517 40	<b>Set of 12 blanking plugs for RJ 45 LCS<sup>2</sup> connector</b> White
10	0 517 41	Black
10	0 335 91	<b>Blanking plate for 19" panel</b> Black

Pack	Cat.Nos	Ethernet switches 100 Mbps
1	0 335 02	Mounted in the patch panel Conform with standards IEEE 802-3, EN 500 81-1 and EN 500 82-1 (Conformity with EMC requirements) <b>Switch units for patch panel</b> Clip directly onto the patch panels 7 RJ 45 ports at the front, 1 of which is a cascade port Power supply with transformer provided
1	0 335 05	6 RJ 45 ports + 1 LC type optic port with front-mounted cascade 100 base FX type LC Power supply via transformer provided

Pack	Cat.Nos	Copper/fibre optic converter units
1	0 335 06	Simply and quickly permit copper to fibre conversion and vice versa Clip directly onto the patch panels Fitted with an SC type fibre optic connector 10/100 base T to 10/100 base FX type SC
1	0 335 07	1000 base T to 1000 base SX type SC

Pack	Cat.Nos	Midspan Power over Ethernet (PoE) injectors, 802.3 af
1	0 335 01	4 inlets/outlets Used for supplying 4 Wi-Fi access points Clips directly onto a patch panel
1	0 327 37	1 inlet / outlet Used for supplying a Wi-Fi access point Direct connection to the patch panel

Pack	Cat.Nos	RJ 45 doubler sockets
10	0 765 39	Provide increased security against theft and damage to double connectors Provide a rate of 10/100 Mbps Multidirectionnal cable entry Can be installed in all supports depth min. 35 mm 1 module
10	0 765 38	<b>Ethernet/Ethernet - Mosaic Programme</b> ○ White FTP - 9 contacts UTP - 8 contacts
10	0 765 37	<b>Telephone/Ethernet - Mosaic Programme</b> ○ White FTP - 9 contacts

Pack	Cat.Nos	RJ 45 doubler sockets (continued)
10	5 723 36	<b>Telephone/Ethernet - FTP - Arteor</b> 9 contacts ○ White
10	5 728 36	● Magnesium
10	0 765 36	<b>Telephone/Ethernet - UTP - Mosaic Programme</b> 8 contacts ○ White
10	5 723 35	<b>Telephone/Ethernet - UTP - Arteor</b> 8 contacts ○ White
10	5 728 35	● Magnesium
10	0 765 35	<b>Telephone/telephone - Mosaic Programme</b> 45 contacts ○ White

Pack	Cat.Nos	Mobile doublers
10	0 327 83	Clip into RJ 45 sockets to double applications TV/computer network or telephone double connector
10	0 327 47	Telephone/telephone doubler
10	0 327 45	Computer network/telephone doubler
10	0 327 46	L1/L2 telephone doubler
10	0 327 48	Computer network/computer network double connector

Pack	Cat.Nos	Weatherproof adaptors
10	0 695 80	IP 55 - IK 07 Allow all functions to be adapted 2 Mosaic modules IP 55 operation Adaptor with smoked flap
1	0 695 79	Adaptor with smoked flap lockable by special tool
1	0 695 81	Adaptor for RJ socket ensuring IP 44 weatherproof with cable connected
1	0 919 45	Locking tool (used for changing vandal-proof screws)
1	0 778 80	<b>Soliroc adaptors</b> Used for adapting all functions 2 Mosaic modules IK 10 - IP 55 Adaptor with flap
1	0 778 81	Adaptor without flap
5	0 539 49	<b>Hypra adaptor</b> IP 55 adaptor base

## Legrand cabling system LCS<sup>2</sup> category 6A, 6 and 5e - telephone panels, units and cables



0 335 79

Pack	Cat.Nos	
1	0 335 79	<b>Patch panel telephone 50 ports 110 connect</b> 19" panel - 1 U
		<b>Cables for telephone networks</b> PVC sleeve - cat. 3 Colour white Colour code TIA/EIA
1	0 328 91	<b>U/UTP - 50 pairs</b> Length 500m Supplied on reel
1	0 328 88	<b>U/UTP - 100 pairs</b> Length 500m Supplied on reel
		<b>Panels and units for incoming telephone</b> <b>Assembled panels - 1 U</b> Fitted with 4 LCS <sup>2</sup> RJ 45 units of 12 ports with fast tool-free connection
1	0 335 31	3-6/4-5 contacts for digital telephone
1	0 335 30	4-5/7-8 contacts for analogue telephone
		<b>Incoming telephone units for self-assembly panels</b> Fitted with 12 LCS <sup>2</sup> RJ 45 ports with quick tool-free connection
2	0 335 33	3-6/4-5 contacts for digital telephone
2	0 335 32	4-5/7-8 contacts for analogue telephone
		<b>110 tool</b>
1	0 332 60	110 tool
5	0 332 61	Replacement blade

## Legrand cabling system LCS<sup>2</sup> category 6A, 6 and 5e - accessories



0 517 09

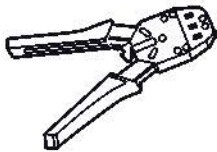

0 327 60

Pack	Cat.Nos	
		<b>Crimping tool for RJ 45 plugs</b> Used for crimping plugs RJ 4/6/8/9 contacts Ratchet control of crimping mechanism Able to cut and strip cables Tool with 3 crimping points High resistance steel material
1	0 517 09	
		<b>RJ plugs for round cables</b> Gold-coated contacts 1.2 µm
50	0 517 01	<b>RJ 11</b> 4 contacts, width 9.65 mm
50	0 517 02	<b>RJ 12</b> 6 contacts, width 9.65 mm
50	0 517 03	<b>RJ 45 cat. 5e</b> 8 contacts, width 11.70 mm
50	0 517 04	9 contacts, width 11.70 mm
50	0 517 06	<b>RJ 45 sleeves</b> Black
50	0 517 07	White
		<b>Cable protection accessories</b> Plastic material IP 66/67 guaranteed connection with the pair 0 533 02 IP 55 with no connection for base with shutter Protection for RJ 45 shielded or unshielded cables ensuring a link of category 5 Conform to standards of the IEC 60603-7 series and to standard IEC 61076-3-106 (version 5) Compatible with products on the market Compatible with products on the market conforming to the standards listed
3	0 533 00	<b>Plug</b> Integrated PE with sealing ring and clamping blades Tool-free assembly Ability to protect cables of category 5e
3	0 533 01	<b>Flush-mounting base</b> Locking base Supplied with RJ 45 female / female coupler cat. 5e
3	0 533 02	<b>Kit</b> Flush-mounting base + plug
3	0 533 03	<b>Protective flap</b> Fits on base Cat.No 0 533 01
		<b>Stripping tool</b> Slits the sheath and releases the conductors by rotation For twisted pair cables Does not damage the conductors
1	0 332 62	<b>Stripper</b> For twisted pair and fibre optic cable
1	0 327 60	<b>Cutting pliers</b> Cut wires cleanly without damaging the copper





0 325 15



0 325 06



0 325 10



0 325 08

Fibre cables:

- fibre colour code: FOTAG
- standard: EN 50173-2, ISO IEC 11801

Pack	Cat.Nos	OS1/OS2 singlemode optical cables (9/125 µm)
2000 <sup>1</sup>	Loose tube 0 325 12	900 µm Tight buffer For 9/125 µm singlemode installations (OS1) Yellow jacket Indoor/outdoor (universal) 6 fibres
2000 <sup>1</sup>	0 325 13	Outdoor, corrugated steel tape 6 fibres
2000 <sup>1</sup>	0 325 14   0 325 50	Indoor/outdoor (universal) 12 fibres
2000 <sup>1</sup>	0 325 15	Outdoor, corrugated steel tape 12 fibres
2000 <sup>1</sup>	0 325 51	Indoor/outdoor (universal) 24 fibres

Pack	Cat.Nos	OM 4 multimode optical cables (50/125 µm)
500 <sup>1</sup>	900 µm Tight buffer 0 326 65	For 50/125 µm multimode installations (OM 4) Blue jacket Compatible with 10 Giga Ethernet network Indoor/outdoor (universal) 6 fibres
1000 <sup>1</sup>	0 326 66	Indoor/outdoor (universal) 6 fibres
1000 <sup>1</sup>	0 326 67	Indoor/outdoor (universal) 12 fibres
1000 <sup>1</sup>	0 326 68	Indoor/outdoor (universal) 24 fibres

Pack	Cat.Nos	OM 3 multimode optical cables (50/125 µm)
2000 <sup>1</sup>	Loose tube 0 325 10	For 50/125 µm multimode installations (OM 3) Green jacket Indoor/outdoor (universal) 6 fibres
2000 <sup>1</sup>	0 325 11	Indoor/outdoor (universal) 12 fibres
2000 <sup>1</sup>	0 325 53   0 325 52	Indoor/outdoor (universal) 24 fibres

Pack	Cat.Nos	OM 2 multimode optical cables (50/125 µm)
2000 <sup>1</sup>	Loose tube 0 325 55	For 50/125 µm multimode installations (OM 2) Orange jacket Indoor/outdoor (universal) 4 fibres
2000 <sup>1</sup>	0 325 04   0 325 08	Indoor/outdoor (universal) 6 fibres
2000 <sup>1</sup>	0 325 05	Outdoor, corrugated steel tape 6 fibres
2000 <sup>1</sup>	0 325 06   0 325 09	Indoor/outdoor (universal) 12 fibres
2000 <sup>1</sup>	0 325 07	Outdoor, corrugated steel tape 12 fibres

1: in meter(s)

## FIBRES PRE-FITTED WITH CONNECTORS

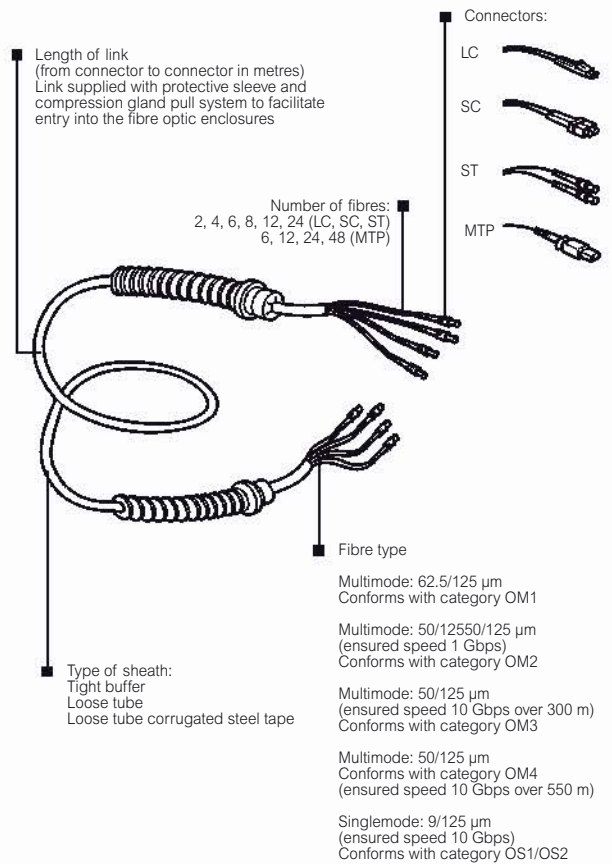

## DOCUMENTS

Each link is supplied with a test report (fibre by fibre) and illustrated operating instructions

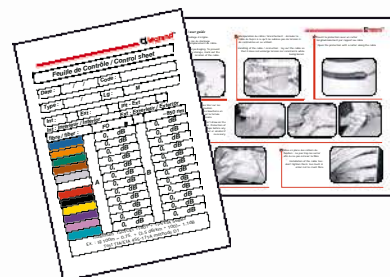

## PACKAGING

According to length of link:  
- packed on a reel  
- packed on a ring  
Connector protection by tube



Reel

# Legrand cabling system LCS<sup>2</sup> fibre optic

## 19" fibre optic drawers and fibre sockets



"Tail-coat" enclosure rear for easier cable entry



0 335 09 fitted with fibre optic units



0 325 20



0 335 13



0 335 12



0 335 11 fitted with fibre optic unit 0 335 17







0 786 17



0 786 18

Pack	Cat.Nos	19" slide-in modular optic drawers
1	0 335 10	Limit switch stop with 45° slope Depth 220 mm, height 1 U Maximum capacity: - 24 x ST and SC connectors ST - 48 x LC connectors Supplied with screws and wiring accessories
1	0 335 09	Takes up to 4 fibre optic units (see below) Supplied with 24 SC connectors
<b>19" Linkeo optic drawers</b>		
1	0 325 20	Fastening kit of 4 cage nuts Depth 200 mm, width 483 mm, height 1 U Incoming cable area at the bottom 1 cable seal for cable from 6 to 12 mm 1 fibre management kit 1 splice bridge (12 splices) Maximum capacity: 24 SC connectors (loaded adaptors)
1	0 325 22	Maximum capacity: 48 LC connectors (loaded adaptors)
<b>Fibre optic units</b>		
		Clip directly onto the fibre optic drawer Cat.No 0 335 10 or on the patch panels with fibre optic cassette Cat.No 0 335 11
<b>Singlemode fibre units (9/125 µm)</b>		
1	0 335 13	LC unit for 6 singlemode fibres
1	0 335 12	SC unit for 6 singlemode fibres
1	0 327 86	SC/APC unit for 4 singlemode fibres
<b>Multimode fibre units (62.5 and 50/125 µm)</b>		
1	0 335 16	ST unit for 6 multimode fibres
1	0 335 17	SC unit for 6 multimode fibres
1	0 335 18	LC unit for 6 multimode fibres
1	0 335 19	High-density LC unit for 12 multimode fibres
<b>Switch/fibre optic unit</b>		
1	0 335 05	Power supply via transformer provided 6 x RJ 45 ports + 1 cascade LC type optic port at the front Clips directly onto the patch panels
<b>Copper/fibre optic converter units</b>		
		For simple and fast copper to fibre conversion and vice versa Clip directly onto the patch panels Fitted with an SC type fibre optic connector
1	0 335 06	10/100 base T to 10/100 base FX type SC
1	0 335 07	1000 base T to 1000 base SX type SC
<b>Fibre optic cassette for patch panel</b>		
1	0 335 11	Ensures fibre coiling (from 2 to 12 fibres) Takes a fibre optic unit Cat.Nos 0 335 12/13/16/17/18/19 Used for linking copper and fibre optic blocks on the same LCS <sup>2</sup> patch panel

Pack	Cat.Nos	Blanking plate for 19" panel
10	0 335 91	Black
<b>Cassette for pigtails</b>		
1	0 329 07	12-fibre capacity
1	0 326 72	24-fibre capacity
<b>Sockets with fibre optic feedthrough</b>		
		Fitted with duplex feedthrough 2 inlets/2 outlets Used for connecting 2 fibres (fitted with their connector) Supplied with protective caps Fitted with transparent marker holder 2 modules
<b>Socket with fibre optic feedthrough 2 x ST</b>		
1	0 786 16	Bayonet connection (STII compatible)  ○ White
<b>Socket with fibre optic feedthrough 2 x SC</b>		
1	0 786 17	Push-pull connection  ○ White
<b>Socket with fibre optic feedthrough 2 x LC</b>		
1	0 786 18	Push-pull connection  ○ White
<b>Socket with fibre optic feedthrough 2 x SC/APC</b>		
1	0 786 14	Push-pull connection With shutters  ○ White

## Legrand cabling system LCS<sup>2</sup> fibre optic

### 19" high density fibre optic drawer



0 325 69 (not equipped)

Pack	Cat.Nos	19" high density fibre optic drawer
1	0 325 69	Modular fibre optic drawer Slide-in and modular drawer Maximum capacity: - 36 ST and SC connectors - 72 LC connectors Depth 220 mm, height 1 U Supplied with screws and wiring accessories Receives up to 3 fibre optic units below
		<b>Fibre optic units</b>
		Clip directly onto the optic drawer Cat.No 0 325 69
		<b>Singlemode fibre units (9/125 µm)</b>
3	0 325 73	LC duplex unit for 12 singlemode fibres - blue
3	0 325 74	LC quadriplex unit for 24 singlemode fibres - blue
3	0 325 70	ST duplex unit for 12 singlemode fibres - blue
3	0 325 71	SC duplex unit for 12 singlemode fibres - blue
3	0 325 72	MPO unit type A for 6 x 12 singlemode fibres - blue
		<b>Multimode fibre units (62.5 and 50/125 µm)</b>
3	0 325 78	LC duplex unit for 12 multimode fibres - beige
3	0 325 79	LC quadriplex unit for 24 multimode fibres - beige
3	0 325 75	ST duplex unit for 12 multimode fibres - beige
3	0 325 76	SC duplex unit for 12 multimode fibres - beige
3	0 325 77	MPO unit type A for 6 x 12 multimode fibres - beige
		<b>Accessory</b>
10	0 335 93	Blanking plate
		<b>Accessories common to 2 fibre optic drawers</b>
		<b>Cassette for pigtails</b>
1	0 329 07	12-fibre capacity
1	0 326 72	24-fibre capacity
		<b>Bend limiting clip</b>
10	0 335 94	Fibre management bend limiting clip

## Legrand cabling system LCS<sup>2</sup> fibre optic

### floor distribution cabinets, equipment



0 462 91

Pack	Cat.Nos	19" fibre optic drawer equipped with SC units
1	0 335 09	Fibre optic drawer equipped with 4 SC fibre optic units for 6 multimode fibres Modular sliding drawer End stop, tilted at 45° Depth 220 mm, height 1 U Supplied with screws and wiring accessories
		<b>OM 3 multimode optical cords (50/125 µm)</b>
		Suitable for 10 Gb Ethernet network Max. optical losses: 0.3 dB For 50/125 µm multimode installations, type OM 3 Purple sheaths
		<b>SC/SC duplex cords</b>
3	0 326 09	Length: 1 m
3	0 326 10	Length: 2 m
3	0 326 11	Length: 3 m
		<b>SC/LC duplex cords</b>
3	0 326 12	Length: 1 m
3	0 326 13	Length: 2 m
3	0 326 14	Length: 3 m
		<b>OM 3 multimode fibre optic cables (50/125 µm)</b>
		For 50/125 µm multimode installations, type OM 3 Green sheaths Suitable for 10 Gb Ethernet network
2000	0 325 10	Tight jacketed 900 µm Internal/external (glass sheath) 6 fibres
2000	0 325 52	Internal/external (glass sheath) 24 fibres
		<b>Fibre optic floor distribution cabinets</b>
		Reversible metal cabinets with key-operated lock IP 20 - IK 08 Maximum capacity: - 24 fibres with ST connectors - 48 fibres with SC connectors - 96 fibres with LC connectors Up to 4 fibre optic units can be fitted Cat.Nos 0 325 71/72/73/74/76/77/78/79, 0 335 12/13/16/17/18/19 4 cable entries (2 at the top and 2 at the bottom) 12 outlets, 22 mm diameter (3 at the top, 3 at the bottom and 6 at the sides) Supplied with 1 black ISO 20 cable gland to hold the incoming cable and 15 feedthrough covers The outgoing cables can be clamped using a clamp at the back of the cabinet Can take 2 cassettes for pigtails Cat.No 0 329 07 (incoming and outgoing) 292 x 323 x 92 mm Black RAL 9005
1	0 462 91	Cabinet equipped with 2 SC fibre optic units for 12 multimode fibres
1	0 462 90	Modular cabinet



# Legrand cabling system LCS<sup>2</sup> fibre optic

FTTO - Full IP



0 779 05



0 326 80



0 335 43

Pack	Cat.Nos	Shared work areas	Pack	Cat.Nos	Individual work areas (continued)
1	0 779 05	<p>Conforming to IEEE 802.3 (Ethernet), POE 802.3af, PoE+ 802.3at, 802.1x (authentication via port), 802.1q VLAN trunking Compatible with SNMP, IPv6, QoS level 2 (802.1p) and level 3 (DiffServ), VLAN, Rapid Spanning Tree, IGMPv3 snooping</p> <p><b>Fibre optic/copper switch</b> Used to convert and distribute the optical signal to four 10/100/1000 RJ 45 ports with auto-MDI/X and PoE/PoE+ auto-negotiation on the front One 10/100/1000 RJ 45 port with auto-MDI/X and auto-negotiation on the side for network extension Fully manageable, without fan One SFP fibre optic port 1000 base SX included, LC connector Labelling of each port with label-holder For integration in all 4-module supports, depth 50 mm minimum Supplied with its own power supply Cat.No 0 779 06, max. power 60 W 4 modules - White</p> <p><b>Power supply for fibre optic/copper switch</b> Power supply for fibre optic/copper switch Cat.No 0 779 05 - 6 modules For installation in trunking only</p>	1	0 326 83	<p><b>Auxiliary contact</b> For active zone box Cat.No 0 326 80 Used to feed back volt-free data to the IP network For integration directly in the active area box (automatic connection)</p> <p><b>Battery</b> For active area box Cat.No 0 326 80 Provides continuity of operation of the active area box in the event of a power cut 52 V - 800 mAh Integrated directly in the active area box (automatic connection)</p>
1	0 779 06	<p><b>Individual work areas</b></p> <p><b>Active area box</b> Used to convert and distribute the optical signal to five 10/100/1000 RJ 45 ports Used to power IP devices via RJ 45 ports in PoE or PoE+ One SFP fibre optic port 1000 base SX included, LC connector Labelling of each port with label-holder For installation in false ceilings or raised access floors using supports Cat.Nos 0 326 81/82 230 V~ power supply Conforming to IEEE 802.3 (Ethernet), POE 802.3af, PoE+ 802.3at, 802.1x (authentication via port), 802.1q VLAN trunking Compatible with SNMP, IPv6, QoS level 2 (802.1p) and level 3 (DiffServ), VLAN, Rapid Spanning Tree, IGMPv3 snooping</p> <p><b>Supports</b> Integral optical fibre coiling cassette with quadriplex LC feedthrough</p> <p>Used to install the active area box Cat.No 0 326 80 in a false ceiling Access to the area box with a pivoting flap Support for spare cords</p> <p>Used to install the active area box Cat.No 0 326 80 in a raised access floor</p>	2000	0 325 10	<p><b>OM 3 multimode fibre optic cables (50/125 µm)</b> For 50/125 µm multimode installations, type OM 3 Green sheaths Suitable for 10 Gb Ethernet network Internal/external (glass sheath) 6 fibres</p>
1	0 326 81		2000	0 325 52	<p>Internal/external (glass sheath) 24 fibres</p>
1	0 326 82		1	0 335 43	<p><b>Ready-assembled area distribution box</b> For extra low voltage distribution Centralises connections to guarantee flexibility and adaptability of the installation Installed in a false ceiling or raised access floor Connects to the floor distribution cabinet Connection to a Mosaic socket with copper feedthrough with an RJ 45/RJ 45 cord IP 21 - IK 07 Conforming to standards UTE C 15-900, NF C 15-100, NF C 20-730, EN 50-174.2, IEC 60950, ISO/IEC 11801 ed. 2.0, EN 50173-2 and IEA/TIA 568 Colour code EIA/TIA 568 A and B Cords and cables: ISO 11801 id.2.0, EN 50173-1, EIA/TIA 568 Technical characteristics: - polycarbonate PC hood - polypropylene PP base - RAL 7035 - Resistance of connector units on the box: 100 N - Cables anchored on support using Colring cable ties</p> <p>Ready-assembled area box with: - a fibre optic accessory for mounting fibre optic modules and coiling the fibre - an SC fibre optic unit for 6 multimode fibres</p>

# Legrand cabling system LCS<sup>2</sup> fibre optic

## optic connectors and pigtails



Pack	Cat.Nos	Tool case for preparing optic fibres for optic connectors
1	0 326 90	Provides the tools required for preparing optic cables, for carrying out initial tests of the connection of fibres to connectors and the accessories for easy connection in all situations Comprises: - Installation instructions and video - Stripping tool (for fibres and cables) - Cleaving tool - Microscope for checking the quality of the cut - Visual fault locator with cord - Accessories (ultra-strong scissors, marker, protective glasses, etc.)
1	0 326 91	<b>Update kit for case Cat.No 0 331 93</b> Comprises: - Visual fault locator with cord - Adaptors for connectors - Connector support for easier connection - Fibre positioning label to be affixed to the cleaver in case Cat.No 0 331 93
		<b>Fast-connection connectors</b> Quick to connect, reliable and can be reused up to 5 times Microswitch for locking the fibre inside the connector and illuminated indicator for checking for faults at the end of the process These connectors do not require any glue, polishing or special tools For installation on tight jacketed fibre (diam. 900 µm) For loose jacketed fibre (diam. 250 µm), use a spreader Cat.No 0 330 48 or 0 330 49
10	0 326 57	<b>Multimode connectors</b> SC/UPC connector 50 µm OM3/OM4 900 µm
10	0 326 58	LC/UPC connector 50 µm OM3/OM4 900 µm
10	0 326 56	ST/UPC connector 50 µm OM3/OM4 900 µm
10	0 326 62	SC connector 62.5 µm OM1 900 µm
10	0 326 61	ST connector 62.5 µm OM1 900 µm
		<b>Singlemode connectors</b>
10	0 326 52	SC/UPC connector 9 µm OS1/OS2 900 µm
10	0 326 53	LC/UPC connector 9 µm OS1/OS2 900 µm
10	0 326 54	SC/APC connector 9 µm OS1/OS2 900 µm

Pack	Cat.Nos	Pigtails
		Supplied with 900 µm sleeve, 1 m
10	0 326 70	<b>10 Gb - 50/125 µm OM4</b>
1	0 326 71	LC connector Kit of 12 LC-connector pigtails
6	0 326 22	<b>10 Gb - 50/125 µm OM3</b>
6	0 326 23	SC connector
1	0 326 27	LC connector
1	0 326 26	6 x LC-PC connectors 12 x LC-PC connectors
		<b>9/125 µm OS1/OS2</b>
4	0 326 19	SC/APC connector
6	0 326 20	SC connector
6	0 326 21	LC connector
1	0 326 25	6 x LC-UPC connectors
1	0 326 24	12 x LC-UPC connectors
		<b>Thermoretractable sleeve for pigtails</b>
1	0 327 44	40 mm - pack of 50 sleeves
		<b>Glue-on connectors 50/125 and 62.5/125 µm</b>
		Supplied with sleeve 900 µm Connectors with ceramic ferrule Typical attenuation: 0.3 dB
10	0 331 27	ST connector
10	0 331 47	SC connector
10	0 331 00	LC connector
		<b>Breakout kits</b>
1	0 330 48	For 900 µm of optical fibres Take 250 µm fibre diameters 6 fibre breakout kit
1	0 330 49	12 fibre breakout kit

# Legrand cabling system LCS<sup>2</sup> fibre optic

## optic connectors

### Technical characteristics

- Connection of connectors on 900 µm fibre
- Maximum attenuation 0.3 dB
- Ideal for high-speed systems: 10 gigabit Ethernet
- Operating temperature: 0 to 65 °C
- Shallow connectors

### Advantages:

- High quality finish
- Can be reused 5 times
- Shallow connector, depth less than 40 mm
- Connector factory pre-polished and does not require any glue
- No special tools, easy to transport
- Speed of installation: simple connection process, quick training  
It takes less than five seconds to fit the connector

### The basic steps

#### Preparation of the fibre:

Stripping



Cleaving



Inspection



#### Connection:

1/ Insert the fibre in the connector



2/ Slide the switch on the connector - the splice is done



3/ Slide the boot onto the connector

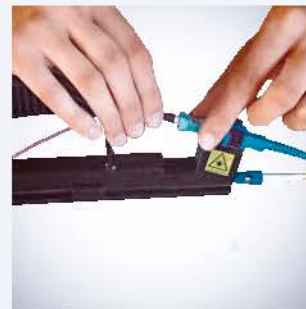

Finally, the visual fault locator is used to check the connection.

### Rapid crimping connectors with tool case Cat.No 0 326 90

#### Types of connector

- ST connector: Helical shape locked by "push and turn" bayonet type connector



- SC connector: Rectangular shape "push-pull" latch type locking  
Suitable for a large number of active devices  
Recommended in the generic standards ISO/IEC 11801 and EN 50173



- LC connector: Rectangular shape tab locking  
Half the size of a conventional connector



### Maximal length of channel by fibre optic application

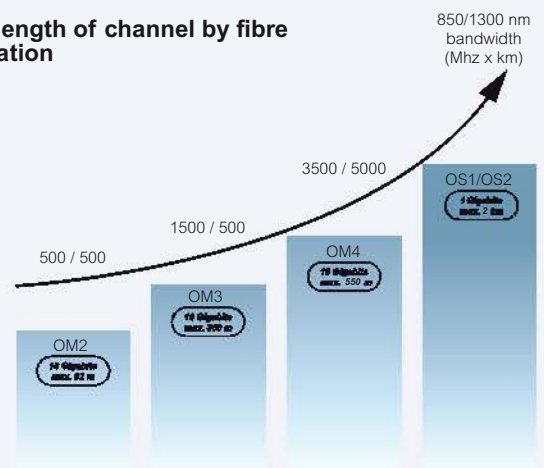

Applications	Multimode			Monomode
	OM2	OM3	OM4	OS1/OS2
10 Gigabits Ethernet (S/R base)	82 m	300 m	550 m <sup>(1)</sup>	NA
Giga Ethernet (LX base)	550 m	550 m	550 m	2 km
Giga Ethernet (SX base)	550 m	550 m	1100 m	NA

■ TIA 568

□ Applications IEEE 802.3

1: Engineered solution using a max. cabled fibre attenuation of 3.0 dB/km. If not distance is of 400 m

# Legrand cabling system LCS<sup>2</sup> fibre optic

## area distribution boxes



0 335 40



0 335 40 fitted with SC fibre optic unit, accessory  
Cat.No 0 335 20 and a 6 x RJ 45 connector unit



0 335 20 fibre optic  
accessory



0 786 16







0 786 17



0 786 18

Pack	Cat.Nos	Area distribution box
1	0 335 40	<p><b>Area distribution box</b></p> <p>For distribution of low current in an area fitted with 1 to 12 RJ 45 sockets Centralise connections to guarantee flexibility and adaptability of the installation Installed on false ceiling or false floor Connect to the patch panel or the floor cabinet Conform to standards UTE C 15-900, NF C 15-100, NF C 20-730, EN 50-174.2, CEI 60950, ISO/IEC 11801 Ed. 2.0, EN 50173-2 and TIA/EIA 568 Colour code and wiring schemes T 568 A and T 568 B Cords and cables: ISO 11801 Ed.2.0, EN 50173-1, TIA/EIA 568</p> <p>Technical characteristics:</p> <ul style="list-style-type: none"> <li>- polycarbonate PC hood</li> <li>- polypropylene PP base</li> <li>- RAL 7035</li> <li>- hold connector units in place in the box: 100 N</li> <li>- Cables anchored on support using Colring cable ties</li> </ul> <p><b>Self-assembly area distribution box</b> Used for fitting fibre optic accessory units</p>
1	0 335 20	<p><b>Fibre optic accessory</b></p> <p>Used for fitting fibre optic units (p. 685) and the fibre coil in the area distribution box</p>

Pack	Cat.Nos	Sockets with fibre optic feedthrough
1	0 786 16	<p><b>Sockets with fibre optic feedthrough</b></p> <p>Fitted with duplex feedthrough 2 inlets/2 outlets Used for connecting 2 fibres (fitted with their connector) Supplied with protective caps Fitted with transparent marker holder 2 modules</p> <p><b>Socket with fibre optic feedthrough 2 x ST</b> Bayonet connection (STII compatible)</p>  <p>○ White</p>
1	0 786 17	<p><b>Socket with fibre optic feedthrough 2 x SC</b> Push-pull connection</p>  <p>○ White</p>
1	0 786 18	<p><b>Socket with fibre optic feedthrough 2 x LC</b> Push-pull connection</p>  <p>○ White</p>
1	0 786 14	<p><b>Socket with fibre optic feedthrough 2 x SC/APC</b> Push-pull connection With shutters</p>  <p>○ White</p>

# Legrand cabling system LCS<sup>2</sup> fibre optic

## Patch cords



Technical characteristics p. 714

Fitted with 2 connectors with ceramic ferrule at either end  
Packed and tested individually (report supplied)  
Zipcord LSZH sleeve

Pack	Cat.Nos	OS1/OS2 (UPC) singlemode optical cords
		Max. optical losses: 0.3 dB For OS1 9/125 µm singlemode installations, OS1 type Yellow sheaths
3	0 326 00	<b>SC/SC duplex cords</b> Length: 1 m
3	0 326 01	Length: 2 m
3	0 326 02	Length: 3 m
3	0 326 03	<b>SC/LC duplex cords</b> Length: 1 m
3	0 326 04	Length: 2 m
3	0 326 05	Length: 3 m
3	0 326 28	<b>LC/LC duplex cords</b> Length: 0.5 m
3	0 326 06	Length: 1 m
3	0 326 07	Length: 2 m
3	0 326 08	Length: 3 m
3	0 326 29	Length: 5 m

Pack	Cat.Nos	OM 4 multimode optical cords (50/125 µm)
		Suitable for 10 Gb Ethernet network Max. optical losses: 0.3 dB For 50/125 µm multimode installations, OM 4 type Blue sheaths
3	0 326 30	<b>SC/SC duplex cords</b> Length: 1 m
3	0 326 31	Length: 2 m
3	0 326 32	Length: 3 m
3	0 326 33	<b>LC/LC duplex cords</b> Length: 0.5 m
3	0 326 34	Length: 1 m
3	0 326 35	Length: 2 m
3	0 326 36	Length: 3 m
3	0 326 37	Length: 5 m

Pack	Cat.Nos	OM 3 (PC) multimode optical cords (50/125 µm)
		Suitable for 10 Gb Ethernet network Max. optical losses: 0.3 dB For 50/125 µm multimode installations, OM 3 type Purple sheaths
3	0 326 09	<b>SC/SC duplex cords</b> Length: 1 m
3	0 326 10	Length: 2 m
3	0 326 11	Length: 3 m
3	0 326 12	<b>SC/LC duplex cords</b> Length: 1 m
3	0 326 13	Length: 2 m
3	0 326 14	Length: 3 m
3	0 326 15	<b>LC/LC duplex cords</b> Length: 1 m
3	0 326 16	Length: 2 m
3	0 326 17	Length: 3 m

Pack	Cat.Nos	OM 2 (UPC) multimode optical cords (50/125 µm)
		Max. optical losses: 0.3 dB For 50/125 µm multimode installations, OM 2 type Orange sheaths
3	0 330 80	<b>ST/ST duplex cords</b> Length: 1 m
3	0 330 81	Length: 2 m
3	0 330 82	Length: 3 m
3	0 330 69	<b>SC/SC duplex cords</b> Length: 1 m
3	0 330 70	Length: 2 m
3	0 330 71	Length: 3 m
3	0 330 72	<b>ST/SC duplex cords</b> Length: 2 m
3	0 330 73	Length: 3 m
3	0 330 61	<b>LC/LC duplex cord</b> Length: 2 m
3	0 330 75	<b>SC/LC duplex cords</b> Length: 1 m
3	0 330 63	Length: 2 m
3	0 330 76	Length: 3 m
3	0 330 65	<b>LC/ST duplex cord</b> Length: 2 m

## Legrand cabling system LCS<sup>2</sup> Wi-Fi access points



0 335 21



0 779 13



0 335 24

### Technical characteristics p. 715

Pack	Cat.Nos	Manageable Wi-Fi access points 802.11n
		<p>Coverage area: 600 m<sup>2</sup>                      Dual band 2.4 GHz or 5 GHz                      Conforms with standard 802.11 a, b, g, n                      Theoretical speed: 300 Mbps gross                      MIMO 2x2, supports up to 4 SSIDs                      False ceiling integration - PoE power supply (Power over Ethernet - standard IEEE 802.3 af)                      Network connection via a tool-free RJ 45 connector                      The installation must include at least:                      - a Wi-Fi access point (false ceiling)                      - a PoE injector Cat.No 0 335 01 conforming with 802.3 af (LCS<sup>2</sup> unit format) to be installed in the patch cabinet                      Can be configured centrally via controller Cat.No 0 332 25 or via configuration software Cat.No 0 335 24 or individually                      The management function allows the network administrator to manage Wi-Fi access points remotely via a web https interface                      Security via WEP, WPA and WPA2 (802.11i) encryption and 802.1x authentication QOS WMM compatible and supports SNMP management                      Guest access:                      independent access to the private Wi-Fi network                      Energy saving with standby management</p>
1	0 335 22	Wi-Fi surface-mounted access point 802.11n
1	0 335 21	Wi-Fi ceiling-mounted access point 802.11n

Pack	Cat.Nos	Manageable Wi-Fi access points 802.11a & b/g
		<p>Dual-band and dual-radio                      Conform with standards 802.11a and 802.11b/g                      Gross speed: 54 Mbps max. on each frequency (802.11a and 802.11g) simultaneously                      Can be integrated into all compatible supports with minimum 40 mm depth                      Tool-free network connection via RJ 45 connector                      PoE power supply (Power over Ethernet - standard 802.3 af)                      The installation must include at least:                      - Wi-Fi access point                      - a PoE injector conforming with 802.3af (LCS<sup>2</sup> unit format) to be installed in the patch panel                      The management function allows the network administrator to manage Wi-Fi access points remotely via a web interface                      Security via WPA2 encryption (802.11i) and 802.1x authentication                      Guest access: allows visitors free access to the Internet (access independent of the main Wi-Fi network)                      4 modules                      Equipped with an RJ 45 socket on the front panel</p>
1	Mosaic 0 779 14	<p>○ White                      Without RJ 45 socket outlet</p>
1	0 779 13	○ White
	Arteor	
1	5 723 76	With RJ 45 socket on front ○ White
1	5 728 76	With RJ 45 socket on front ● Magnesium
1	5 723 77	With no RJ 45 socket ○ White
1	5 728 77	With no RJ 45 socket ● Magnesium
		<b>Centralised configuration software</b>
1	0 335 24	<p>Access point manager                      Allows the installation of a secure Wi-Fi network with centralised management of the Wi-Fi access points                      The installation must include at least:                      - Wi-Fi access points                      - a PoE injector conforming with 802.3 af (LCS<sup>2</sup> unit format) to be installed in the patch cabinet</p>

## Legrand cabling system LCS<sup>2</sup> switches and PoE injectors



0 779 00



0 332 80

Technical characteristics p. 715

Pack	Cat.Nos	Flush-mounting Ethernet 10/100 base T switches
		For networking computer peripherals without a patch panel: computers, printers, servers, etc. Possibility of extending an existing network by simply replacing an RJ 45 socket Tool-free connection Conform with standards IEEE 802.3 (Ethernet) and EN 500 81/82-2 (EMC requirements) Installation in all supports with minimum 40 mm depth 6 ports at the front + 1 side RJ 45 connector for cabling and carrying out link tests Port status display integrated into the RJ 45 connectors Labelling of each port from 1 to 6 and marker holder for switch identification 6 modules
1	0 779 00	<b>Non manageable 230 V supply - Mosaic Programme</b> ○ White
1	0 779 01	<b>Non manageable PoE supply (802-3 af) supply - Mosaic Programme</b> ○ White
1	5 720 83	<b>Non manageable 230 V supply - Arteor</b> ○ White
1	5 728 84	<b>Non manageable PoE supply (802-3 af) supply - Arteor</b> ● Magnesium
		<b>Power over Ethernet (PoE) injectors Midspan</b>
1	0 335 01	4 inputs/outputs Supply 4 Wi-Fi access points Attach directly to the patch panel conform with standard IEEE 802.3 af
1	0 327 37	1 input/1 output
		<b>Mosaic VDI distribution block without connectors</b>
1	0 332 80	16 modules Dimensions: 135 x 223 x 57 mm For small patch panel For mounting a Mosaic switch Cat.Nos 0 779 00/01/20

## AUDIO/VIDEO SYSTEM

# The right system to meet your needs

A wide range of technologies (HD15, HDMI, DISPLAY PORT, RCA, JACK) to suit the location and the user requirements



■ Female HD15 preterminated socket



■ Audio socket



■ HD15 + 3.5 mm jack amplifier



■ Audio/video 19" patch panel

- Quick installation
- Easy connection
- Optimum performance

# Audio/video system

## audio/video sockets



Pack	Cat.Nos		<b>Female HD15 sockets</b>
			Used to transmit analog video streams (VGA, XGA, UXGA depending on graphic card) between a source (computer) and a compatible receiver (video projector, TV,...)
			<b>Preterminated sockets - 1 module</b> Equipped with cord, length 15 cm
1	Mosaic 0 787 77	Arteor 5 720 97	<ul style="list-style-type: none"> <li><input type="radio"/> White</li> <li><input type="radio"/> Alu</li> <li><input type="radio"/> Magnesium</li> </ul>
1	0 793 77		
1		5 725 97	
			<b>Screw-type female HD15 sockets 2 modules</b>
1	0 787 57	5 722 82	<ul style="list-style-type: none"> <li><input type="radio"/> White</li> <li><input type="radio"/> Alu</li> <li><input type="radio"/> Magnesium</li> </ul>
1	0 792 57		
1		5 727 82	
			<b>Screw-type female HD15 sockets 2 modules + 3.5 mm jack</b>
1	0 787 74	5 722 88	<ul style="list-style-type: none"> <li><input type="radio"/> White</li> <li><input type="radio"/> Magnesium</li> </ul>
1		5 727 88	
			<b>Solder-type female HD15 sockets 1 module</b> 15 pin
1	0 787 72	5 722 79	<ul style="list-style-type: none"> <li><input type="radio"/> White</li> <li><input type="radio"/> Magnesium</li> </ul>
1		5 727 79	

			<b>HDMI type A sockets</b>
			Used to transmit high-definition digital audio/video streams between a source (computer, HD-DVD drive,...) and a compatible receiver (TV, videoprojector,...)
			<b>Preterminated sockets HDMI 1.4 - 1 module</b> Equipped with cord, length 15 cm
1	Mosaic 0 787 78	Arteor 5 720 96	<ul style="list-style-type: none"> <li><input type="radio"/> White</li> <li><input type="radio"/> Alu</li> <li><input type="radio"/> Magnesium</li> </ul>
1	0 793 78		
1		5 725 96	
			<b>Screw-type sockets HDMI 1.3 - 2 modules</b>
1	0 787 68	5 722 81	<ul style="list-style-type: none"> <li><input type="radio"/> White</li> <li><input type="radio"/> Alu</li> <li><input type="radio"/> Magnesium</li> </ul>
1	0 792 75		
1		5 727 81	

			<b>Jack sockets 3.5 mm</b>
			3.5 mm jack connectors can be used to create audio/video links
			<b>Preterminated sockets - 1 module</b> Equipped with cord, length 15 cm
1	Mosaic 0 787 79	Arteor 5 720 91	<ul style="list-style-type: none"> <li><input type="radio"/> White</li> <li><input type="radio"/> Alu</li> <li><input type="radio"/> Magnesium</li> </ul>
1	0 793 79		
1		5 725 91	
			<b>4 screw-type female 3.5 mm jack socket - 1 module</b>
1	0 787 64	5 722 74	<ul style="list-style-type: none"> <li><input type="radio"/> White</li> <li><input type="radio"/> Alu</li> <li><input type="radio"/> Magnesium</li> </ul>
1	0 792 64		
1		5 727 74	
			<b>Solder-type female 3.5 mm jack socket - 1 module</b>
1	0 787 73	5 722 78	<ul style="list-style-type: none"> <li><input type="radio"/> White</li> <li><input type="radio"/> Magnesium</li> </ul>
1		5 727 78	

Pack	Cat.Nos		<b>HD15 + 3.5 mm Jack amplifier</b>
			Used to connect audio/video terminals more than 20 m apart up to 100 m The video link is via an HD15 connector (resolution up to UXGA) The stereo audio link is via a 3.5 mm jack The kit includes: - One 4-module transmitter equipped with an HD15 connector and a 3.5 mm jack - One 4-module receiver equipped with an HD15 connector and a 3.5 mm jack - One 4-module power supply to be connected on the mains then linked to the receiver or transmitter The link between the transmitter and receiver is via a network cord RJ 45/RJ 45
1	Mosaic 0 787 70	Arteor 5 723 70	<ul style="list-style-type: none"> <li><input type="radio"/> White</li> </ul>

			<b>Videoprojector switch</b>
			Universal remote switch allowing to turn ON or place in STANDBY mode a video projector Works with all videoprojectors or TV through IR learning process Installed close to the room's lighting switches, it replaces the constructors remote and fosters the ignition and extinction of the video projector therefore reducing energy consumption and extending the bulb's lifetime
1	Mosaic 0 787 99	Arteor 5 720 89	<ul style="list-style-type: none"> <li><input type="radio"/> White</li> </ul>

			<b>Display port sockets</b>
			Used to transmit high-definition digital audio/video streams between a source (laptop, computer, etc) and a compatible receiver (videoprojector, TV,...)
			<b>Preterminated socket - 1 module</b> Equipped with cord, length 15 cm
1	Mosaic 0 787 91	Arteor 5 720 90	<ul style="list-style-type: none"> <li><input type="radio"/> White</li> <li><input type="radio"/> Magnesium</li> </ul>
1		5 725 90	

Patch panels, cables and cords,  
See p. 696





# Audio/video system

## audio/video sockets (continued)



Pack	Cat.Nos	<b>Female 1 RCA socket</b>
1	Mosaic 0 787 52	Provides the composite video link for any peripheral device such as a DVD drive, camera, video recorder, etc 1 module ○ White

Pack	Cat.Nos	<b>Female 2 RCA sockets</b>
1	Mosaic 0 787 47	Provide the stereo audio link for any peripheral device such as a DVD drive, camera, video recorder 1 module <b>Preterminated</b> Equipped with a 15 cm cord ○ White ● Magnesium
1	Arteor 5 720 92 5 725 92	
1	0 787 53	<b>Connection via screw terminals</b> ○ White ● Magnesium
1	5 722 72 5 727 72	

Pack	Cat.Nos	<b>Female 3 RCA sockets</b>
1	Mosaic	Provide the composite video and stereo audio links for any peripheral device such as a DVD drive, camera, video recorder, videoconferencing, etc 1 module <b>Preterminated</b> Equipped with a 15 cm cord ○ White ● Magnesium
1	Arteor 5 720 93 5 725 93	
1	0 787 54	<b>Connection via screw terminals</b> ○ White ● Alu ● Magnesium
1	0 792 54	
1	5 727 73	

Pack	Cat.Nos	<b>Other audio and video sockets</b>
1	Mosaic 0 787 71	<b>DVI-I socket - 2 modules</b> Used to transmit high-definition digital video streams between a source (computer) and a compatible receiver (TV, videoprojector,...) ○ White
1	0 787 58	<b>Female BNC 75 socket - 1 module</b> Provides the composite video link for any peripheral device such as a DVD drive, camera, video recorder, etc ○ White ● Magnesium
1	5 722 76 5 727 76	

Pack	Cat.Nos	<b>Audio sockets</b>
1	Mosaic 0 787 55	<b>XLR 3-pin - 2 modules</b> Provides the stereo link for microphone, amplifier, mixing console, etc. Recommended cable: 1 audio pair 0.14 mm <sup>2</sup> to 0.5 mm <sup>2</sup> shielded Max. cable length: 50 m (without amplifier) ○ White - Fast screw connection female ● Alu - Fast screw connection female ● Magnesium - Fast screw connection female
1	Arteor 5 722 83	
1	0 792 55	○ White - Fast screw connection male ● Magnesium - Fast screw connection male
1	5 727 83	
1	0 787 56	<b>4-pole Speakon - 2 modules</b> Used to connect power enclosures Recommended cable: 2 audio pairs 4 mm <sup>2</sup> Max. cable length: 50 m (without amplifier) ○ White
1	5 722 77 5 727 77	
1	0 787 60	<b>Loudspeakers sockets</b> Terminal 4 mm <sup>2</sup> ○ White - 2 modules ● Magnesium - 2 modules
10	0 787 51	○ White - 1 module ● Alu - 1 module ● Magnesium - 1 module
10	5 722 80 5 727 80	
10	0 787 50	<b>100 V Line Volume Attenuators - 2 modules</b> Allow to adjust power and volume of a 100 V loudspeaker line ○ White - 100 V - 25 W ● Magnesium - 100 V - 25 W
10	0 792 50 5 727 70	
1	0 787 76	○ White - 100 V - 25 W ● Magnesium - 100 V - 25 W
1	5 722 84 5 727 84	

## Audio/video system

### audio/video patch panels, cords and cables



0 335 98



0 335 97



0 335 96



0 335 99



0 517 23



0 517 24

Pack	Cat.Nos	19" patch panels
		Used to distribute the audio/video signal Equipped with marked connectors 19" female 1 U metal panels
1	0 335 98	HD15 19" panel - 12 connectors
1	0 335 97	HDMI 19" panel - 16 connectors
1	0 335 96	XLR 19" panel - 16 connectors
1	0 335 99	SUBD9 19" panel - 12 connectors
		<b>Cords</b>
		For connecting a socket to a terminal
1	0 517 23	<b>HD15 cord</b> Length 10 m For connecting an HD15 socket to a video terminal (PC, video projector, etc.)
1	0 517 22	<b>HD15 cord + 3.5 mm jack</b> Length 2 m For connecting an HD15 video socket and a 3.5 mm audio jack to a terminal (PC, video projector)
		<b>HDMI 1.4 cord</b> For connecting an HDMI socket to an audio/video terminal (plasma screen, DVD player, home cinema, games console, etc.) For use over a distance of more than 10 m, use the HDMI booster Cat.No 0 779 30
1	0 517 26	Length 1.5 m
1	0 517 27	Length 5 m
1	0 517 20	Length 10 m
1	0 779 30	<b>HDMI booster</b> Used to extend an HDMI connection Consists of 2 female connectors and used as an addition to the HDMI cord (for example cord Cat.No 0 517 20) Does not need external power supply
1	0 517 24	<b>XLR cord</b> Length 10 m For connecting an XLR socket to an audio peripheral (microphone, amplifier, etc.)
1	0 517 25	<b>9-way SUB-D cord</b> Length 10 m For RS 232 serial connection (printer, machine screen, etc.)

Pack	Cat.Nos	Cables
		For connecting 2 sockets a long distance apart
1	0 327 81	<b>VGA cables</b> Length 20 m For full pin connection of HD15 sockets over distances of up to 20 m
1	0 327 80	<b>HDMI cables</b> Length 20 m For connecting HDMI sockets over distances of up to 10 m



# Audio/video system

kits



0 787 97



0 789 09



0 789 10

Technical information **see e-catalogue**

Pack	Cat.Nos					
1	<table border="1"> <tr> <td>Mosaic</td> <td>Arteor</td> </tr> <tr> <td>0 787 97</td> <td>5 720 24</td> </tr> </table>	Mosaic	Arteor	0 787 97	5 720 24	<p><b>HD15 video kit</b></p> <p>Up to 15 m Ideal for classrooms and small meeting rooms Used to transmit analogue video streams (VGA, XGA, UXGA depending on graphic card) between a source (computer) and a compatible receiver (video projector, TV) over a length of 15 m The video link is via an HD15 connector. The kit includes: - 2 female HD15 preterminated sockets 1 module - 1 HD15 cord length 15 m - 1 video projector switch (2 modules) and 1 push-button (2 modules) with supports and plates ○ White</p>
Mosaic	Arteor					
0 787 97	5 720 24					
1	<table border="1"> <tr> <td>Mosaic</td> <td>Arteor</td> </tr> <tr> <td>0 789 09</td> <td>5 720 26</td> </tr> </table>	Mosaic	Arteor	0 789 09	5 720 26	<p><b>Audio/video multi-participant transmitter HD15+3.5 mm Jack</b></p> <p>Allows the different participants in a meeting room to broadcast a presentation on their PC by pressing the shutter button control without disconnecting the cable from the projector Must be associated with other transmitters and one receiver Can be installed in pop-up, desktop multi-outlet extensions and DLP trunking The video link is via an HD15 connector and the stereo audio link is via a 3.5 mm Jack HD15+3.5 mm Jack cord length 2 m included for connection to a PC Transmitters are connected by RJ 45 patch cord (not included) ○ White - 4 modules</p>
Mosaic	Arteor					
0 789 09	5 720 26					
1	<table border="1"> <tr> <td>Mosaic</td> <td>Arteor</td> </tr> <tr> <td>0 787 98</td> <td>5 720 25</td> </tr> </table>	Mosaic	Arteor	0 787 98	5 720 25	<p><b>Audio/video HD15+3.5 mm Jack amplifier kit</b></p> <p>Up to 100 m Ideal for large meeting rooms Used to transmit audio and analogue video streams (VGA, XGA, UXGA depending on graphic card) between a source (computer) and a compatible receiver (video projector, TV) over a length (up to 100 m) The video link is via an HD15 connector and the stereo audio link is via a 3.5 mm Jack The link between the transmitter and receiver is via RJ 45 patch cord (not included) The kit includes: - 1 transmitter HD15+3.5 mm Jack - 4 modules - 1 receiver HD15+3.5 mm Jack - 4 modules - 1 power supply- 4 modules - 2 HD15+3.5 mm cord length 2 m - 1 video projector switch (2 modules) and 1 push-button (2 modules) with supports and plates ○ White</p>
Mosaic	Arteor					
0 787 98	5 720 25					
1	<table border="1"> <tr> <td>Mosaic</td> <td>Arteor</td> </tr> <tr> <td>0 789 10</td> <td>5 720 27</td> </tr> </table>	Mosaic	Arteor	0 789 10	5 720 27	<p><b>Audio/video multi-participant receiver HD15+3.5 mm Jack</b></p> <p>Receives commands from the audio/video multi-participant transmitter Can be installed in pop-up, desktop multi-outlet extensions and DLP trunking The video link is via an HD15 connector and the stereo audio link is via 3.5 mm Jack HD15 + 3.5 mm Jack cord length 2 m included for connection to a video projector Must be associated with the first transmitter by a RJ 45 patch cord (not included) ○ White - 2 x 4 modules</p>
Mosaic	Arteor					
0 789 10	5 720 27					

# Legrand cabling system LCS<sup>2</sup> enclosures

## LCS<sup>2</sup> 19" cabling freestanding cabinets



0 463 41

0 463 34 + 1 cabinet 0 463 18  
+ 1 extension cabinet 0 463 30

### Technical characteristics p. 717 to 719

IP 20 - IK 08 baying cabinets with single or double curved front door made of screen-printed safety glass. Side and rear removable panels. Panels with automatic equipotential connection. Lock with 2433 A key for locking of the 4 sides. Top and bottom cable entries (19" cut-out format) receive 19" plates with brushes, fans, etc. Equipped with 4 x 19" uprights with U marking and depth adjusting aid. Option of cable and patch cord management in cabling unit. Cat.Nos 0 463 34/35. Cabinets can be dismantled completely where access is difficult. Levelling feet adjustable from the inside. Loading capacity: 420 Kg. Charcoal grey RAL 7016

Pack	Cat.Nos	LCS <sup>2</sup> 19" cabling cabinets			
		<b>Single front door</b>			
		Reversible door			
		Capacity	Height (mm)	Width (mm)	Depth (mm)
1	0 463 00	24 U	1226	600	600
1	0 463 06	29 U	1448	600	600
1	0 463 12	33 U	1626	600	600
1	0 463 18	42 U	2026	600	600
1	0 463 19	42 U	2026	600	800
1	0 463 21	42 U	2026	800	600
1	0 463 22	42 U	2026	800	800
1	0 463 23	42 U	2026	800	1000
1	0 463 28	47 U	2248	800	800
1	0 463 29	47 U	2248	800	1000
		<b>Double front door</b>			
		Door opening suitable for small spaces			
		Capacity	Height (mm)	Width (mm)	Depth (mm)
1	0 463 41	42 U	2026	800	600
1	0 463 42	42 U	2026	800	800
1	0 463 43	42 U	2026	800	1000

Pack	Cat.Nos	LCS <sup>2</sup> 19" extension cabinet			
		Single front door. No side panels Supplied with baying kit			
		Capacity	Height (mm)	Width (mm)	Depth (mm)
1	0 463 30	42 U	2026	600	600
1	0 463 33	42 U	2026	800	800

Pack	Cat.Nos	LCS <sup>2</sup> baying kits	
		For direct linking 2 LCS <sup>2</sup> cabinets For cabinet depth (mm):	
1	0 463 37	600	
1	0 463 38	800	
1	0 463 39	1000	

Pack	Cat.Nos	LCS <sup>2</sup> cabling units	
		Can be attached between 2 LCS <sup>2</sup> 42 U cabinets Easier cable and patch cord management Width 250 mm Supplied with earthing kit Charcoal grey RAL 7016 For cabinet depth (mm):	
1	0 463 34	600	
1	0 463 35	800	

# Legrand cabling system LCS<sup>2</sup> enclosures

## LCS<sup>2</sup> 19" server freestanding cabinets and accessories

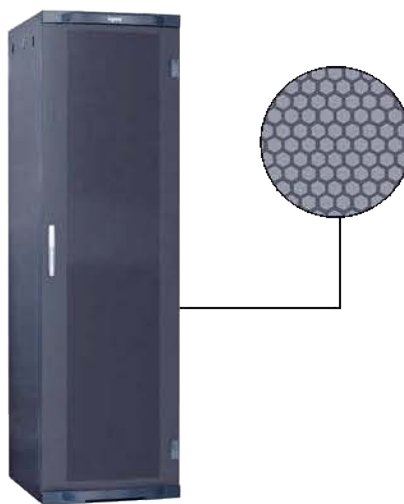

0 463 85

### Technical characteristics p. 717 to 719

IP 20 - IK 08  
Baying cabinets with front and rear metal microperforated door (80 %), reversibles, can be opened without key. Front door can be fitted with a DIN European cylinder (30 + 10 mm), with option of fitting a handle Cat.No 0 347 71/72 (p. 260). Rear door can be fitted with a key barrel Cat.Nos 0 368 22/23/24/25/26/27. Removable side panels. Top cable entries in 19" cut-out format, capable of taking 19" plates with brushes, fans, etc. Open bottom cable entries. Equipped with 4 x 19" uprights with depth adjusting aid. Levelling feet adjustable from the inside. Cabinets can be dismantled completely where access is difficult. Supplied with earthing kit. Loading capacity: 630 Kg. Charcoal grey RAL 7016

Pack	Cat.Nos	LCS <sup>2</sup> 19" server cabinets			
		Capacity	Height (mm)	Width (mm)	Depth (mm)
1	0 463 85	42 U	2026	600	1000
1	0 463 86	42 U	2026	800	1000

Pack	Cat.Nos	LCS <sup>2</sup> baying kit	
		For direct linking 2 LCS <sup>2</sup> cabinets For cabinets depth (mm):	
1	0 463 39	1000	

Pack	Cat.Nos	Accessories for LCS <sup>2</sup> 19" server cabinets	
		<b>Set of 4 castor wheels</b> Set of 4 pivoting castors, 2 of which have brakes Load on the 4 wheels: 500 kg	
1	0 464 82		
		<b>Cable trays</b> Fast screw-free assembly of cable guides (p. 701)	
1	0 464 78	For width 600/800 mm Fitted between 2 supports Cat.No 0 464 79	
1	0 464 79	For depth 1000 mm Pre-cut every 100 mm for height 500 to 200 mm	



Plinths, cable entry plates, thermal management, cable management and other accessories, p. 700-701

LCS<sup>2</sup> 19" equipment p. 702

1200 mm deep LCS<sup>2</sup> server cabinet please consult us

# Customised

## LCS<sup>2</sup> 19" freestanding cabinets



### ↓ LCS<sup>2</sup> 19" FREESTANDING CABINETS

#### 40 SIZES

Capacity	24 U	29 U	33 U	42 U	47 U
Width	600 or 800 mm				
Depth	600, 800, 1000 or 1200 mm				

#### CABINET DEFINITION

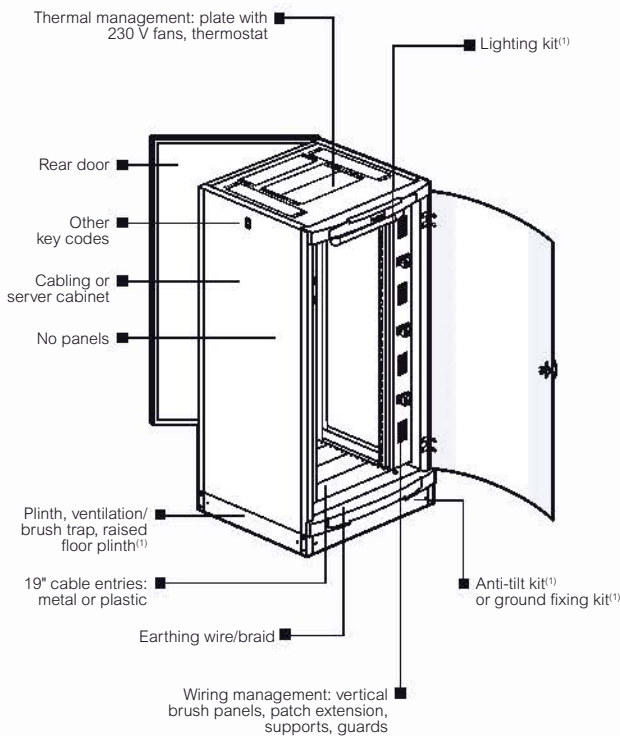

1 : Supplied ready for assembly

Option of solid or microperforated metal doors, screen-printed glass doors, double doors or no doors

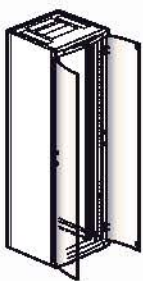

Cabinet fitted with screen-printed glass double door at the front (42 U/47 U; width 800 mm)

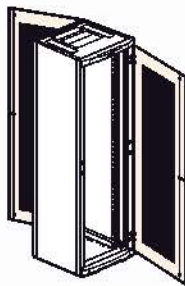

Cabinet fitted with microperforated metal doors at the front and rear (opening to the left)

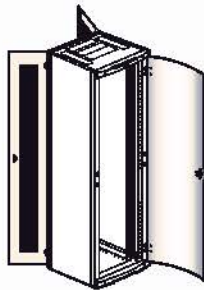

Cabinet fitted with microperforated metal double rear door and screen-printed glass front door

### ↓ LCS<sup>2</sup> 19" FREESTANDING CABINETS (CONTINUED)

#### 19" EQUIPMENT ASSEMBLY

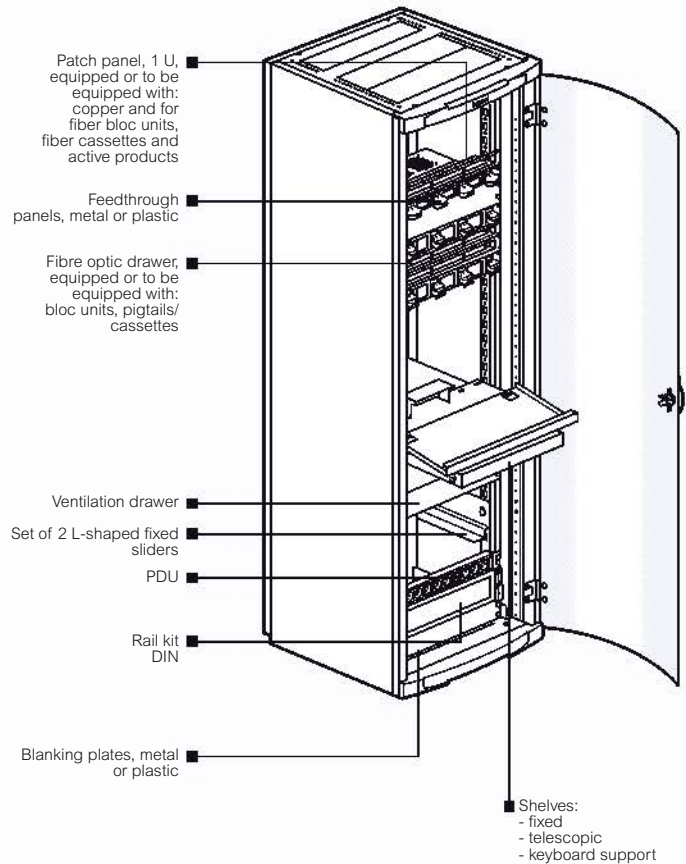

### ↓ COLOURS



180 RAL colours available.  
Optional touch-up brush in the selected RAL

## OUR COMMITMENT

Request a quotation from our technical team

# LCS<sup>2</sup> 19" cabinets and server cabinets

## plinths and adjustable height plinths



Kit 0 464 52 comprising 4 corner blocks and solid traps at front/rear



0 464 61



0 464 63



Cross Bar 0 476 93 with cable guide



0 464 66



For technical floor



0 464 32

### Technical characteristics p. 718-719

Pack	Cat.Nos	Plinths for cabinets
		Metal. Open on 4 sides Anthracite grey RAL 7016
		<b>Plinth kits</b> Consisting of 4 corner blocks and solid front/rear traps height 100 mm Side traps to be ordered separately For cabinet width (mm):
1	Height 100   0 464 50   0 464 52	600
1	Height 200   0 464 51   0 464 53	800
		<b>Sets of 2 solid side traps</b> Trap height 100 mm Order 2 sets for a plinth height of 200 mm (Cat.No 0 464 52/53) For cabinet depth (mm):
1	0 464 54	600
1	0 464 56	800
1	0 464 58	1000
		<b>Ventilated traps</b> 1 trap height 100 mm For cabinet width/depth (mm):
1	0 464 60	600
1	0 464 61	800
		<b>Traps with brushes</b> 1 trap height 100 mm For cabinet width/depth (mm):
1	0 464 62	600
1	0 464 63	800
		<b>Plinth for cabling units</b>
1	0 464 64	For mounting between the plinths of the associated cabinets Trap height 100 mm Double the number of traps for a height of 200 mm Anthracite grey RAL 7016
		<b>Cross bars</b>
		Fixed between 2 cabinet plinth corner blocks For clamping cables between associated cabinets and fixing a cable guide (p. 701) For cabinet depth (mm):
1	0 476 93	600
1	0 476 94	800
1	0 476 95	1000

Pack	Cat.Nos	Linking interface
		Make junction between cabinet plinth and cable tray to protect cables Supplied with weatherproof brush Reversible cover with cut-outs providing a high-quality finish Height 200 mm. Anthracite grey RAL 7016 For cabinet depth 600 mm
1	0 464 66	
		<b>Adjustable height plinths for raised access floors</b>
		Transfer the load of the cabinet directly to the ground Height adjustable from 200 to 350 mm in 25 mm steps to adapt to different floor heights Levelling feet for fine adjustment For floor tiles 30 or 38 mm thick Permissible load: 1000 kg
		<b>Adjustable height plinths</b>
		Front and rear floor tile supports included For cabinet width/depth (mm):
1	<b>N</b> 0 464 30	600 x 600
1	0 464 31	600 x 800
1	0 464 32	600 x 1000
1	0 464 34	800 x 600
1	0 464 35	800 x 800
1	0 464 36	800 x 1000
		<b>Set of 2 tile support brackets</b>
		Fix onto adjustable height plinths to support the side tiles For plinths depth (mm):
1	0 464 38	600
1	0 464 39	800
1	0 464 40	1000

## LCS<sup>2</sup> 19" cabinets and server cabinets

cable entries, thermal management and PDU supports

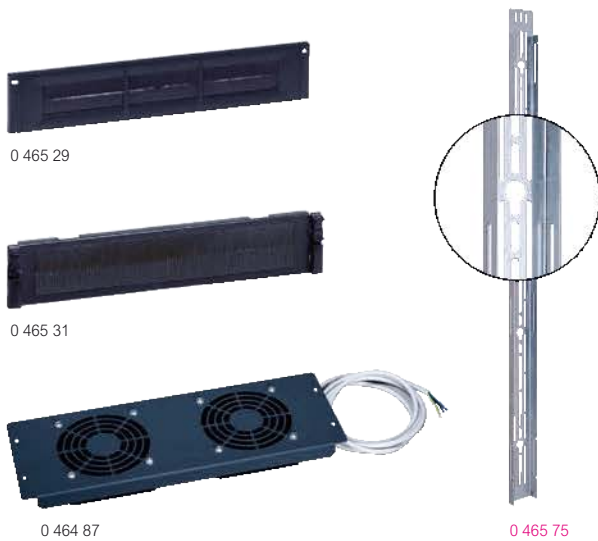

## LCS<sup>2</sup> 19" cabinets and server cabinets

cable management, patch extension

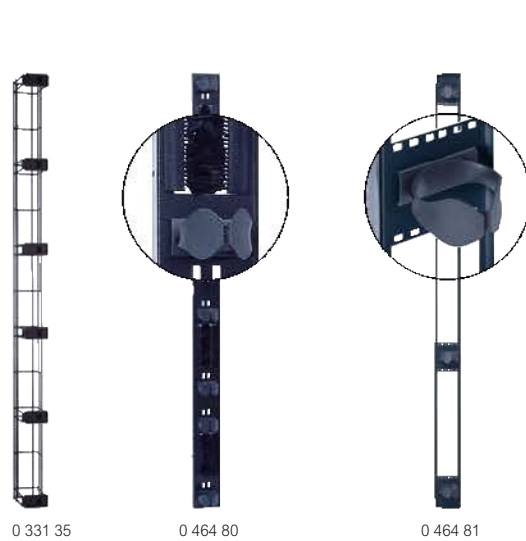

Technical characteristics p. 719-720

Pack	Cat.Nos	19" cable entry plates
		Black RAL 9005
1	0 465 28	<b>Plastic plates with brushes, snap on</b>
1	0 465 29	1 U
		2 U
1	0 465 30	<b>Metal plates with brush</b>
1	0 465 31	1 U
		2 U
		<b>Thermal management</b>
		<b>Plates with fans 3 U</b>
		Fix onto the 19" cable entries
		2.5 m power supply cable. 230 V~
		Anthracite grey RAL 7016
1	0 464 87	2 fans
1	0 464 88	3 fans
		<b>1 U ventilation drawers</b>
		For internal air circulation. Fix on 2 x 19" uprights
		ON/OFF switch. Supplied with power supply cord
		230 V~. Black RAL 9005
1	0 464 89	Drawer with 2 fans
		Depth 150 mm
1	0 464 90	Drawer with 4 fans
		Depth 300 mm
		<b>Thermostat</b>
1	0 348 48	Adjustable from 5 to 60°C, 230 V~, 50/60 Hz
		NC contact (5 A) and NO contact (10 A)
		Magnetic mounting
		<b>PDU supports</b>
		Vertical support for fixing to the rear of 19" LCS <sup>2</sup>
		cabinets and server cabinets (see p. 725). For
		mounting 19" PDU vertically and vertical PDU
1	0 465 75	For 42 U cabinets
1	0 465 76	For 47 U cabinets
		<b>Accessories</b>
1	0 464 84	<b>Anti-tilt kit</b>
		Stabilises a cabinet when heavy items
		installed on telescopic equipment are
		being removed
1	0 464 86	<b>Floor fixing kit</b>
		Used for permanently fixing
		a cabinet to the ground by locking the
		levelling feet
1	0 464 83	<b>Casters</b>
		Set of 4 pivoting casters
		Total permissible load on the 4 casters: 380 kg

Pack	Cat.Nos	Cable and cord management
		<b>Set of 3 cable management supports</b>
		Fix on structure
		Quick, screw-free mounting of cable guides
1	0 464 72	For cabinets width/depth 600 mm
1	0 464 73	For cabinets width/depth 800 mm
1	0 464 74	For cabinets depth 1000 mm
		<b>Flat cable guides</b>
		Quick, screw-free mounting on cable
		management supports
		Width 250 mm
1	0 464 76	For 33 U cabinet
1	0 464 77	For 42 U cabinets
		<b>U-shaped cable guides</b>
		For creating a cable tray
		Used with cross bars
		Cat. No 0 476 93/94/95 in a 200 mm high plinth on
		associated cabinets, and 0 464 78/79
		supports on server cabinets
		Height 54 mm - Length 3 m
1	0 464 69	Width 200 mm
1	0 464 70	Width 400 mm
		<b>Vertical cable management grille</b>
		For 42 U cabinets - width 800 mm
		Fixes onto 19" uprights
1	0 331 35	Grille with articulated bolts
		1560 x 100 x 150 mm
		<b>Vertical cable manager</b>
		For 42 U cabinets - width 800 mm
		Fixes onto 19" uprights
1	0 464 80	Set of 2 vertical panels with brush feedthroughs
		Supplied with 10 cable guide rings Cat.No 0 465 42,
		3 cable ties Cat.No 0 331 94, 3 cable ties
		Cat.No 0 331 95 and 3 cable ties Cat.No 0 331 96
		Black RAL 9005
		<b>Patch extension</b>
		For 42 U cabinets - width 800 mm
		Fixes onto 19" uprights
1	0 464 81	Set of 2 uprights for increasing the capacity of
		the cabinet by 12 U, for mounting 19" equipment
		vertically (feedthrough panels, 19" PDU, etc.)
		Supplied with 8 cable guide rings Cat.No 0 465 42
		Black RAL 9005

Cable ties, document holders  
p. 713



0 465 01



0 465 22



0 465 23



0 465 06



465 29



0 465 32

**Technical characteristics p. 719**

Pack	Cat.Nos	Fixed shelves
		For cabinets and server cabinets Quick, screw-free mounting. Black RAL 9005
		<b>Projecting mounting on 2 x 19" uprights</b> Height 2 U. Max. load: 15 kg
1	0 465 00	Depth 115 mm
1	0 465 01	Depth 200 mm
1	0 465 02	Depth 360 mm
		<b>Fixing on 4 x 19" uprights</b> Height 1 U. Max. load: 50 kg
1	0 465 05	Shelf depth 425 mm For depth 600 mm
1	0 465 06	Shelf depth 625 mm For depth 800 mm
1	0 465 07	Shelf depth 825 mm For depth 1000 mm
		<b>Telescopic shelves</b> For cabinets and server cabinets Quick fixing on 4 x 19" uprights Height 1 U. Max. load: 50 kg. Black RAL 9005
1	0 465 08	Shelf depth 425 mm For depth 600 mm
1	0 465 09	Shelf depth 625 mm For depth 800 mm
1	0 465 10	Shelf depth 625 mm For depth 1000 mm
		<b>Shelves for heavy items</b> Max. load: 100 kg For cabinets depth 1000 mm (server cabinet only for telescopic shelf) Screw fixing on 4 x 19" uprights. Black RAL 9005
1	0 465 17	Fixed shelf depth 820 mm, 1 U
1	0 465 18	Telescopic shelf depth 820 mm, 2 U
		<b>Keyboard support shelf</b> For cabinets and server cabinets For depth 800 mm and 1000 mm Screw fixing on 4 x 19" uprights Max. load: 50 kg. Black RAL 9005
1	0 465 19	Can take: - a computer screen - a keyboard on the retractable support - a mouse on a sliding shelf with integrated mat Area for mouse or CD
		<b>Sets of 2 fixed sliders</b> For cabinets and server cabinets Fixing on 4 x 19" uprights Max. load: 50 kg
1	0 465 11	For depth 600 mm
1	0 465 12	For depth 800 mm
1	0 465 13	For depth 1000 mm

Pack	Cat.Nos	19" management panels
		For organisation and circulation of patch cords Black RAL 9005
		<b>Metal 2 axes, quick-fixing</b> Horizontal and through run. Fitted with plastic cable guide rings radiating out for optimum protection of the cords (compliance with the bending radius) Quick, screw-free fixing
1	0 465 22 <sup>1</sup>	1 U
1	0 465 23 <sup>1</sup>	2 U
		<b>Plastic with brushes, snap on</b>
1	0 465 28 <sup>2</sup>	1 U
1	0 465 29 <sup>2</sup>	2 U
		<b>Metal with brushes, quick-fixing</b> Quick, screw-free fixing
1	0 465 30 <sup>1</sup>	1 U
1	0 465 31 <sup>1</sup>	2 U
		<b>19" blanking plates</b> Black RAL 9005
		<b>Plastic, snap on</b>
1	0 465 32 <sup>2</sup>	1 U
1	0 465 33 <sup>2</sup>	2 U
		<b>Metal, quick-fixing</b> Quick, screw-free fixing
1	0 465 38 <sup>1</sup>	1 U
1	0 465 39 <sup>1</sup>	2 U
1	0 465 40 <sup>1</sup>	3 U
		<b>19" lighting kit</b> 19" metal panel with a lighting kit with switch Quick, screw-free fixing Supplied with 230 V~ - 8 W fluorescent tube
1	0 464 85 <sup>1</sup>	1 U
		<b>Fixing screws</b> Set of 50 cage nuts, 50 plastic washers and 50 x M6 screws
1	0 364 53	With 8.5 mm cage nuts
1	0 364 54	With 9.5 mm cage nuts

<sup>1</sup>: Can be mounted on 19" racks with screws Cat.No 0 464 23 (see opposite)  
<sup>2</sup>: Not for mounting on 19" racks



# Legrand cabling system

## 19" racks and accessories



Technical characteristics p. 720-721

Pack	Cat.Nos	19" racks
1	0 464 06	Racks for high-density cabling (e.g. SANs, main distributors, etc.) Channel type 19" uprights for guiding and fixing cables, with U marking and tapped holes for fixing 19" equipment. Roofing for right-left cord routing that complies with the bending radiuses Receive 19" LCS <sup>2</sup> metal management panels, 19" power distribution units and the LCS <sup>2</sup> 19" DIN rail kit fastened by screws Cat.No 0 464 23 (1 set of 50 supplied with the rack) Supplied with straps with hook and loop type closure Aluminium structure to be assembled Loading capacity: 675 kg Racks joined using grids Cat.Nos 0 464 25/26/27 Black
1	0 464 07	Capacity      Height (mm)      Width (mm)      Depth (mm)      Depth of uprights (mm) 45 U      2185      604      521      267
1	0 464 25	45 U      2185      604      667      413
1	0 464 26	<b>Cord management grids</b> To be mounted between 2 joined racks or on an isolated rack The grid creates a 63 mm space between 2 joined racks for running cables and cords to the front and rear Capacity: 200 cat. 6 cords Black
1	0 464 27	Grid with hinged closing latches 1965 mm x 153 mm x 156 mm
1	0 464 26	<b>Cord management grids with door</b> Easily removable door that opens in both directions To be mounted between 2 joined racks or on an isolated rack (Cat.No 0 464 26 only) The grids create a space between 2 joined racks (63 mm for Cat.No 0 464 26, 165 mm for Cat.No 0 464 27) for running of cables and cords to the front and rear Side cord channels every 1 U Capacity: 200 cat. 6 cords for Cat.No 0 464 26, 580 cords for Cat.No 0 464 27 Supplied with 12 bend limiting clips and 4 coiling supports Black
1	0 464 26	1970 mm x 165 mm x 204 mm
1	0 464 27	1970 mm x 267 mm x 331 mm

Pack	Cat.Nos	Cable tray supports
1	0 464 18	To be fitted in the depth of the rack to support high cable trays Cat.Nos 0 464 69/70 (p. 701)
1	0 464 19	For rack Cat.No 0 464 06 For rack Cat.No 0 464 07
1	0 464 15	<b>Lower finishing plates</b> Metal plates provide the finishing of the lower part of the rack and protection against dust. The sides of the plates can be folded easily for direct insertion of cables in the 19" upright channel.
1	0 464 16	For rack Cat.No 0 464 06 For rack Cat.No 0 464 07
1	0 465 70	<b>19" cord management panels</b> 1 axis closed panels with pivoting cover 172 mm depth Noir
1	0 465 71	1 U 2 U
1	0 464 23	<b>19" equipment screws</b> Set of 50 special screws for 19" racks and 25 earthing claws

# Legrand cabling system LCS<sup>2</sup> enclosures

## LCS<sup>2</sup> 19" wall-mounting cabinets and accessories



0 462 01



0 462 11



Pivoting cabinet 0 462 11



0 465 01

### Technical characteristics p. 722-723

IP 20 - IK 08

With reversible curved print screen glass safety door

Pivoting side panels, tool-free removal from inside

Lock closure with key 2433 A

Equipped with 2 x 19" uprights with depth adjusting aid

Supplied with earthing kit

Top and bottom grilles for natural ventilation, capable of taking a fan in the high part

Charcoal grey RAL 7016

Pack	Cat.Nos	Fixed LCS <sup>2</sup> 19" cabinets			
		Easier cable management: ability to fix cable guide connecting rings Cat.Nos 0 465 41/42 and cable ties (p. 713)			
		DLP format cable entries at the top and bottom, bendable, with ability to attach cables using cable ties			
		Rear pre-cut cable entries			
		<b>Cabinet depth 400 mm</b>			
		Capacity	Width (mm)	Height (mm)	Load capacity (kg)
1	0 462 00	6 U	600	350	18
1	0 462 01	9 U	600	500	27
1	0 462 02	12 U	600	600	36
1	0 462 03	16 U	600	800	48
		<b>Cabinet depth 580 mm</b>			
1	0 462 06	9 U	600	500	27
1	0 462 07	12 U	600	600	36
1	0 462 08	16 U	600	800	48
1	0 462 09	21 U	600	1000	63
		<b>Pivoting LCS<sup>2</sup> 19" cabinets</b>			
		Cabinets composed of:			
		- base (wall-fixing)			
		- pivoting body allowing free access to the rear of the cabinet to facilitate installation and maintenance			
		Reversible pivoting direction			
		Full cable entry plate at top and bottom, a brush plate can be fitted Cat.No 0 462 55			
		<b>Cabinet depth 600 mm</b>			
		Capacity	Width (mm)	Height (mm)	Load capacity (kg)
1	0 462 11	9 U	600	500	27
1	0 462 12	12 U	600	600	36
1	0 462 13	16 U	600	800	48
1	0 462 14	21 U	600	1000	63

Pack	Cat.Nos	Fixed shelves	
		Quick fixing without screws	
		Heigh 2 U	
		Max. load 15 kg	
		Black RAL 9005	
		<b>Quick fixing on 2 x 19" uprights</b>	
1	0 465 00	Depth 115 mm. For cabinets depth 400, 580 and 600 mm	
1	0 465 01	Depth 200 mm. For cabinets depth 400, 580 and 600 mm	
1	0 465 02	Depth 360 mm. For cabinets depth 580 and 600 mm	
		<b>Thermal management</b>	
		<b>Fan</b>	
		2.5 m power supply cable	
1	0 462 60	230 V~ fan	
		<b>Thermostat</b>	
1	0 348 48	Adjustable from 5 to 60 °C, 230 V~, 50/60 Hz	
		NO contact (10A) and NC contact (5 A)	
		Fixed by magnet	
		<b>Cable entry</b>	
1	0 462 55	Cable entry plate with brush	
		For pivoting cabinets	
		<b>Cable management rings</b>	
		Direct clipping on front structural uprights of 9 U to 21 U fixed cabinets (Cat.No 0 465 41 only) and on central upright of 580 mm depth cabinets	
4	0 465 41	1 U, plastic. Useable section 1890 mm <sup>2</sup>	
4	0 465 42	2 U, plastic. Useable section 4070 mm <sup>2</sup>	
		<b>Accessories</b>	
1	0 462 64	Set of 4 caster wheels for assembly on pivoting cabinets	
		Total load permissible on the 4 casters: 120 kg	



# Legrand cabling system LCS<sup>2</sup> enclosures

## LCS<sup>2</sup> 10" wall-mounting cabinet for small business



Technical characteristics p. 722-723

Pack	Cat.Nos	LCS <sup>2</sup> 10" cabinet								
1	0 462 20	<p><b>300 mm depth cabinet</b> Compact cabinet suitable for small business applications up to 36 RJ 45 sockets IP 20 – IK 08 Equipped with:</p> <ul style="list-style-type: none"> <li>- 1 reservible curved door made of safety glass</li> <li>- 2 side panels removable from inside</li> <li>- key locking No 2433A</li> <li>- 2 depth-adjustable uprights</li> <li>- top and bottom cable entries to DLP trunking system format</li> <li>- pre-cut back cable entry</li> <li>- top and bottom perforations for natural ventilation</li> </ul> <p>Charcoal grey RAL 7016</p> <table border="1"> <thead> <tr> <th>Capacity</th> <th>Width (mm)</th> <th>Height (mm)</th> <th>Load capacity (kg)</th> </tr> </thead> <tbody> <tr> <td>6 U</td> <td>314</td> <td>352</td> <td>12</td> </tr> </tbody> </table>	Capacity	Width (mm)	Height (mm)	Load capacity (kg)	6 U	314	352	12
Capacity	Width (mm)	Height (mm)	Load capacity (kg)							
6 U	314	352	12							
1	0 335 92	<p><b>10" equipment</b> Supplied with screws and cage nuts</p> <p><b>Modular empty panel</b> 10" panel - 1 U For up to 2 connector units or 2 fibre optic units (p. 669 and 685)</p>								
1	0 462 23	<p><b>Fixed shelf 1 U</b> Depth 120 mm max. load. 10 kg Black RAL 9005</p>								
1	0 462 24	<p><b>PDU (Power Distribution Units)</b> 230 V~ Need 2 U space Supplied with screws and cage-nuts Black</p>								
1	0 462 26	4 x 2P+E German standard sockets								
1	0 462 25	To be equipped with Mosaic 2P+E sockets Capacity: 8 modules								

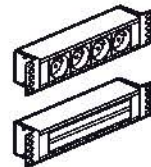

# Customised

## LCS<sup>2</sup> 19" wall-mounting cabinets



### ↓ LCS<sup>2</sup> 19" WALL-MOUNTING CABINETS

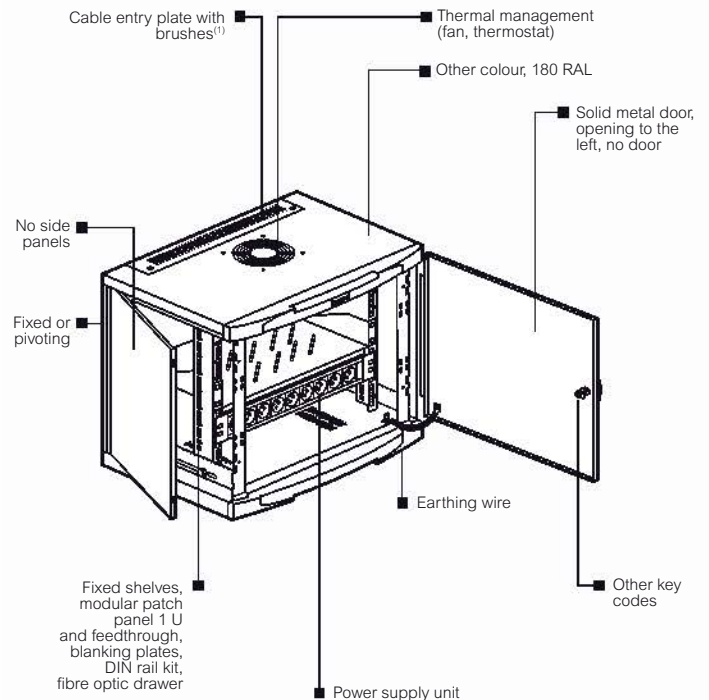

1: Pivoting cabinets

## OUR COMMITMENT

Request a quotation from our technical team

# Energy distribution

## Power Distribution Units (PDU) and DIN rail kit



0 465 88



0 465 50



0 465 65



0 332 78



Kit 0 465 46 + 0 465 47



Technical characteristics p. 724-725

Pack	Cat.Nos	Vertical Power Distribution Units (PDU)	Pack	Cat.Nos	19" Power Distribution Units (PDU) (continued)
		<p>PDU with protection of each circuit by 16 A circuit breaker (equipped with cover for protection against accidental breaks) Mounting in LCS<sup>2</sup> cabling and server cabinet with mounting bracket Cat.Nos 0 465 75/76 (p. 701) Fixing centres: 1697 mm min - 1703 mm max H 1720 x W 55 x D 51/88<sup>(2)</sup> mm Supplied with screws</p> <p><b>Single phase</b> 230 V 50/60 Hz power supply. PDU comprising 2 circuits. The total number of sockets is distributed equally between the 2 circuits Each circuit is identified by colour-coding</p> <p>1 0 465 81 24 x C13 sockets. Connection on 4/6 mm<sup>2</sup> terminal block</p> <p>1 0 465 84 16 x C13 sockets + 6 x C19 sockets</p> <p>1 0 465 80 3 m power supply cord with IEC 60309 2P+E plug 16 A</p> <p>1 0 465 88 24 x 2P+E sockets - French standard Connection on 4/6 mm<sup>2</sup> terminal block</p> <p>1 0 465 88 24 x 2P+E sockets - German standard Connection on 4/6 mm<sup>2</sup> terminal block</p> <p>1 0 465 89 22 x 2P+E sockets - British standard Connection on 4/6 mm<sup>2</sup> terminal block</p> <p><b>3-phase</b> 380 V 50/60 Hz three-phase power supply 1 circuit per phase, each with 8 IEC 60320 C13 sockets and 1 IEC 60320 C19 socket</p> <p>1 0 465 85 24 x C13 sockets + 3 x C19 sockets 3 m power supply cord with IEC 60309 2P+N+E plug 32 A</p>			<p>Power supply 230 V - 50/60 Hz For fixing on 19" fixing centres 180° reversible end piece Connection via 2.5 mm<sup>2</sup> terminal block Provide a 2 U space Supplied with screws</p> <p>1 0 332 78<sup>1</sup> <b>PDU with voltage surge protector unit</b> 6 x 2P+E white sockets - French standard Provides protection against mains overvoltages while keeping sockets energised A red indicator indicates that the protection must be replaced by the surge protector module Cat.No 0 775 41 With switch with indicator</p> <p>1 0 332 79<sup>1</sup> <b>PDU to be equipped</b> Takes 16 Mosaic modules</p>
		<p><b>19" Power Distribution Units (PDU)</b> Power supply 230 V - 50/60 Hz. For fixing on 19" fixing centres. 180° reversible end piece Connection via 2.5 mm<sup>2</sup> terminal block Provide a 2 U space Supplied with screws</p> <p><b>PDU</b></p> <p>1 0 465 51<sup>1</sup> 12 x IEC 60320 C13 sockets</p> <p>1 0 465 52<sup>1</sup> 9 x IEC 60320 C19 sockets</p> <p>1 0 465 50<sup>1</sup> 9 x 2P+E black sockets French standard</p> <p>1 0 465 54<sup>1</sup> 6 x 2P+E black sockets - French standard</p> <p>1 0 332 88<sup>1</sup> 6 x 2P+E white sockets - French standard With switch with indicator</p> <p>1 0 332 37<sup>1</sup> 6 x 2P+E white sockets - French standard With 16 A circuit breaker</p> <p>1 0 332 87<sup>1</sup> 6 x 2P+E tamperproof sockets for uninterruptible power supply (UPS) - French standard</p> <p>1 0 465 60<sup>1</sup> 9 x 2P+E black sockets - German standard</p> <p>1 0 465 62<sup>1</sup> 6 x 2P+E black sockets - German standard</p> <p>1 0 332 38<sup>1</sup> 6 x 2P+E white sockets - German standard With 16 A circuit breaker</p> <p>1 0 465 65<sup>1</sup> 6 x 2P+E black sockets - British standard</p> <p>1 6 339 00<sup>1</sup> 5 x 2P+E white switch sockets - British standard</p>			<p><b>Multi-application DIN rail kit</b> For mounting modular devices (circuit breakers, Legrand multimedia network components, etc) Capacity: 24 modules Height 4 U Screw fixing on 19" uprights DIN profile rail with front panel Supplied with blanking plates 24 modules Black RAL 9005</p> <p>1 0 465 46<sup>1</sup></p> <p>1 0 465 47<sup>1</sup> Rear cover Used with Cat.No 0 465 46 To be used for high current applications (greater than 50 V) Ensures IP XXB Supplied with terminal block (8 + 1 connections)</p>

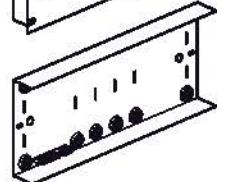
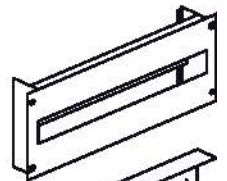
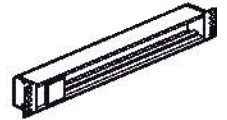
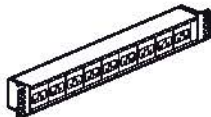

1: Can be mounted on 19" racks with screw Cat.No 0 464 23 (p. 703)  
2: Overall depth at the circuit breaker slot



Metered PDU  
see opposite

# Energy distribution

metered PDU



## DATA CENTER



0 465 95

Technical characteristics p. 724-725

PDU equipped with a digital display ammeter  
 For supplying power to active products in 19" cabinets  
 Measure consumption to provide better installation management:  
 balancing circuits, displaying available capacity, preventing overloads  
 and power failures  
 Measure total PDU current for single-phase version and current per  
 phase for three-phase version

Pack	Cat.Nos	19" PDU
1	0 465 90	For fixing on 19" fixing centres Connection on terminal block Height 1U Supplied with screws 6 x C13 sockets
		<b>Vertical PDU</b>
		Protection of each circuit by circuit breaker with a cover providing protection against accidental breaks Mounting in LCS <sup>2</sup> cabling and server cabinet with mounting bracket Cat.Nos 0 465 75/76 (p. 701) Supplied with screws
		<b>Single phase</b>
		Measurement of the total PDU current 230 V 50/60 Hz power supply PDU comprising 2 circuits with 10 IEC 60320 C13 sockets + 2 IEC 60320 C19 sockets Fixing centre: 1700 mm min. - 1735 mm max. H 1750 x W 62 x D 50/85 <sup>(1)</sup> mm
1	0 465 93	20 x C13 sockets + 4 x C19 sockets
1	0 465 94	Connection on 2.5 - 6 mm <sup>2</sup> terminal block 20 x C13 sockets + 4 x C19 sockets 3 m power supply cord with 32 A IEC 60309 2P+E plug
1	0 465 95	20 x C13 sockets + 4 x C19 sockets 3 m power supply cord with IEC 60320 C20 plug
		<b>Three-phase</b>
		Measurement per phase 380 V 50/60 Hz three-phase power supply 1 circuit per phase, each with 5 IEC 60320 C13 sockets + 1 IEC 60320 C19 socket Fixing centre: 1738 mm min. - 1772 mm max. H 1787 x W 62 x D 45/85 <sup>(1)</sup> mm
1	0 465 96	15 x C13 sockets + 3 x C19 sockets 3 m power supply cord with 32 A IEC 60309 3P+N+E plug

1: Overall depth at the circuit breaker slot

# Performance and reliability at the heart of the server room

Legrand is innovative and offers complete solutions to provide continuity of service and optimise the energy performance of your Data Center and server rooms.

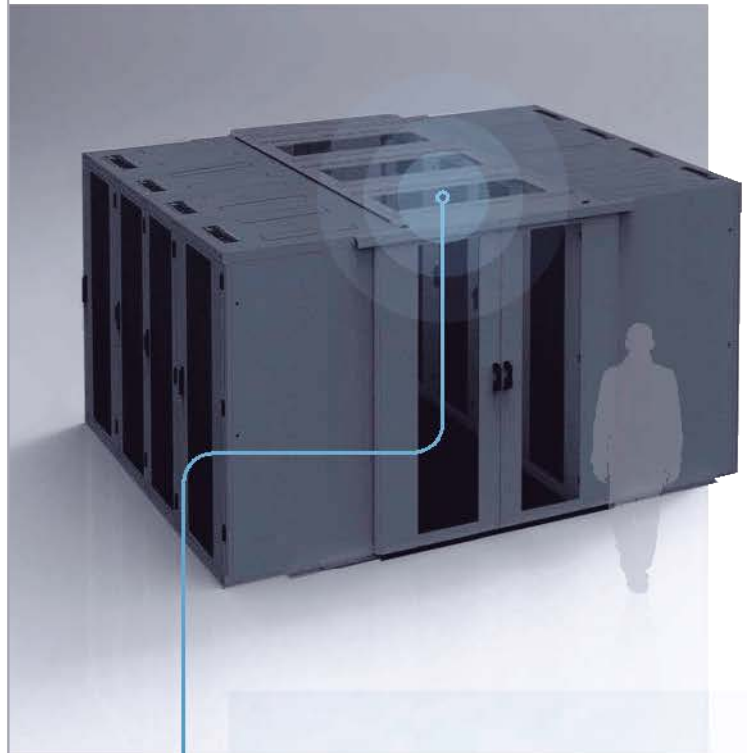

### DEDICATED SOLUTIONS SUCH AS:

- High density fibre optic drawer
- Metered and smart PDU...

For more information, please consult us

**Technical characteristics p. 726-727**

Cabinets supplied in flatpack for compactness. IP 20 - IK 08 baying cabinets. Reversible front door with safety glass window. Removable side and rear panels. 4 sides locked with key lock. 19" uprights adjustable in depth. Pre-cut cable entries that can be fitted with brush cable entry Cat.No 6 464 28 (top and bottom). Cut-out at the top for fan kit. Equipped with levelling feet. Loading capacity: 400 kg. Supplied with earthing kit. Grey RAL 7035

Pack	Cat.Nos	Supplied as 1 part number			
		All the components of the cabinet are supplied in one pack. Stackable wooden case Supplied with 2 x 19" uprights Set of 2 additional 19" uprights Cat.Nos 6 463 40/41/42			
		<b>Cabinets</b>			
		Capacity	Height (mm)	Width (mm)	Depth (mm)
1	6 463 50	24 U	1226	600	600
1	6 463 54	24 U	1226	800	800
1	6 463 62	33 U	1626	600	600
1	6 463 66	33 U	1626	800	800
1	6 463 68	42 U	2026	600	600
1	6 463 69	42 U	2026	600	800
1	6 463 70	42 U	2026	600	1000
1	6 463 71	42 U	2026	800	600
1	6 463 72	42 U	2026	800	800
1	6 463 73	42 U	2026	800	1000
		<b>Extension cabinets</b>			
		No side panels. Supplied with joining kit			
		Capacity	Height (mm)	Width (mm)	Depth (mm)
1	6 463 80	42 U	2026	600	600
1	6 463 83	42 U	2026	800	800

Pack	Cat.Nos	Supplied as 4 part numbers	
		Cabinets supplied in small and light packages for ease of handling. Cabinet split up into 4 part numbers	
		<b>Roof-base</b>	
		Roof and base of the cabinet To mount with structural and 19" uprights	
		Width (mm)	Depth (mm)
1	6 464 50	600	600
1	6 464 51	600	800
1	6 464 52	600	1000
1	6 464 53	800	600
1	6 464 54	800	800
1	6 464 55	800	1000
		<b>Structural and 19" uprights</b>	
		Set of 4 structural uprights and 2 x 19" uprights Set of 2 additional 19" uprights, (if required) Cat.Nos 6 463 40/41/42	
1	6 464 60	Height 24 U	
1	6 464 62	Height 33 U	
1	6 464 63	Height 42 U	

 Wall-mounting cabinets supplied in flatpack  
**p. 710**

 Ready-assembled version available,  
**Please consult us**

Pack	Cat.Nos	Supplied as 4 part numbers (continued)	
		Cabinets supplied in small and light packages for ease of handling Cabinet split up into 4 part numbers	
		<b>Side panels</b>	
		Set of 2 side panels	
		Capacity	Depth (mm)
1	6 464 65	24 U	600
1	6 464 66	24 U	800
1	6 464 71	33 U	600
1	6 464 72	33 U	800
1	6 464 74	42 U	600
1	6 464 75	42 U	800
1	6 464 76	42 U	1000
		<b>Front door and rear panel</b>	
		Capacity	Width (mm)
1	6 464 80	24 U	600
1	6 464 81	24 U	800
1	6 464 84	33 U	600
1	6 464 85	33 U	800
1	6 464 86	42 U	600
1	6 464 87	42 U	800

Pack	Cat.Nos	Baying kits
1	6 463 37	For joining 2 Linkeo 19" cabinets
		<b>19" uprights</b>
		Set of 2 additional 19" uprights
1	6 463 40	24 U
1	6 463 41	33 U
1	6 463 42	42 U
		<b>Plinths</b>
		Metal plinths consisting of 4 corner blocks and 4 removable traps Height 100 mm Grey RAL 7035 For cabinets width x depth (mm):
1	6 464 00	600 x 600
1	6 464 01	600 x 800 or 800 x 600
1	6 464 02	600 x 1000
1	6 464 03	800 x 800
1	6 464 04	800 x 1000

Pack	Cat.Nos	Castors
1	0 464 82	Set of 4 pivoting castors, 2 of which have brakes Total loading capacity on the 4 castors: 500 kg

# Linkeo 19" freestanding cabinets



# Linkeo 19" freestanding cabinets

## flatpack solutions



Pack	Cat.Nos	Fan kits
1	6 464 30	Integrated thermostat, adjustable from - 10 to 80°C 2.5 m cord with 2P+E plug, 230 V~ Grey RAL 7035
1	6 464 31	2 fans 4 fans

Pack	Cat.Nos	Cable management
1	6 464 28	<b>Brush cable entry</b> To fit on top or bottom cabinet pre-cut cable entry Set of brush
1	6 464 20	<b>Vertical cable guides</b> Side or rear mounting on structure For 33 U cabinet
1	6 464 21	For 42 U cabinet

Pack	Cat.Nos	Cable management rings
1	6 464 25	For cabinet width 800 mm. Fix onto 19" uprights Usable dim.: 65 x 145 mm. Black RAL 9005 Set of 6 metal rings

Pack	Cat.Nos	Fixed shelves
1	6 465 01	Black RAL 9005 <b>Screw fixing on 2 x 19" uprights</b> Height 2 U. Max. load: 15 kg Shelf depth 200 mm
1	6 465 02	Shelf depth 360 mm
1	6 465 05	<b>Screw fixing on 4 x 19" uprights</b> Height 1 U. Max. load: 50 kg Shelf depth 425 For depth 600 mm
1	6 465 06	Shelf depth 625 For depth 800 mm
1	6 465 07	Shelf depth 825 For depth 1000 mm

Pack	Cat.Nos	Telescopic shelves
1	6 465 08	Screw fixing on 4 x 19" uprights. Height 1 U Max. load: 30 kg. Black RAL 9005 Shelf depth 425 For depth 600 mm
1	6 465 09	Shelf depth 625 For depth 800 mm
1	6 465 10	Shelf depth 825 For depth 1000 mm

Pack	Cat.Nos	1-axis 19" management panels
1	6 465 20	1 U
1	6 465 21	2 U

Pack	Cat.Nos	2P+E PDU
1	6 465 50	2 m cord with plug
1	6 465 51	9 French-Belgian standard sockets
1	6 465 55	8 French-Belgian standard sockets + switch
1	6 465 56	9 German standard sockets
1	6 465 56	8 German standard sockets + switch
1	6 465 60	8 British standard sockets
1	6 465 61	7 British standard sockets + switch

### Advantages of flatpack solutions

- Easy to carry
- Easy to store
- Easy to handle
- Easy to mount:
  - 16 minutes / 1 person
  - requires only one tool (10 wrench)
  - dedicated installation sheet

### Advantages of delivery in 1 part number

High protection packaging for long distance transportation

- All in one:
- easy to order



### Advantages of delivery in 4 part numbers

- Transportation and storage cost reduction
- Easy handling (small and light package)
- Keep door and panels apart to protect them
- Easy to configure extension cabinet (buying kit to be ordered separately)
- Four additional cabinet sizes

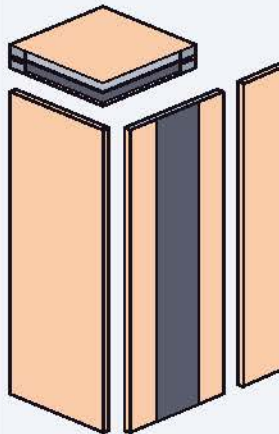

### Selection chart for delivery as 4 part numbers

Cabinet dimensions H x W x D	Roof-base	Structural and 19" uprights	Side panels	Front door and rear panel
24U 600 x 600	6 464 50	6 464 60	6 464 65	6 464 80
24U 600 x 800	6 464 51	6 464 60	6 464 66	6 464 80
24U 800 x 600	6 464 53	6 464 60	6 464 65	6 464 81
24U 800 x 800	6 464 54	6 464 60	6 464 66	6 464 81
33U 600 x 600	6 464 50	6 464 62	6 464 71	6 464 84
33U 600 x 800	6 464 51	6 464 62	6 464 72	6 464 84
33U 800 x 600	6 464 53	6 464 62	6 464 71	6 464 85
33U 800 x 800	6 464 54	6 464 62	6 464 72	6 464 85
42U 600 x 600	6 464 50	6 464 63	6 464 74	6 464 86
42U 600 x 800	6 464 51	6 464 63	6 464 75	6 464 86
42U 600 x 1000	6 464 52	6 464 63	6 464 76	6 464 86
42U 800 x 600	6 464 53	6 464 63	6 464 74	6 464 87
42U 800 x 800	6 464 54	6 464 63	6 464 75	6 464 87
42U 800 x 1000	6 464 55	6 464 63	6 464 76	6 464 87
<b>Extension cabinets</b>	same as above, without side panels			



# Linkeo 19" wall-mounting cabinets

Reliable and easy-to-install solutions

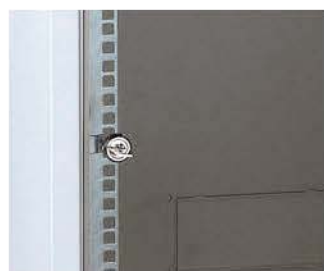

■ Reversible flat safety glass door with integrated lock.



■ Supplied with 2 x 19" uprights adjustable in depth.



■ Adjustable top cable entry with foam seal.  
■ Rear and bottom cable entries equipped with blanking plates.

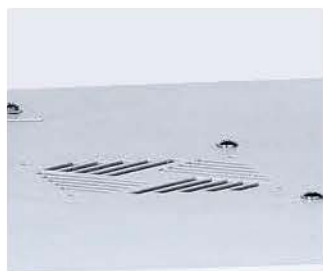

■ Top perforations for natural ventilation.  
■ Can be equipped with fan kit.



Technical characteristics p. 728

IP 20 - IK 08  
Cabinets with reversible flat safety glass door with integrated lock  
Simple two-step wall fixing: base + cabinet  
Equipped with 2 x 19" uprights adjustable in depth  
Adjustable top cable entry with foam seal  
Rear and bottom cable entries equipped with blanking plates  
Top perforations for natural ventilation, capable of taking the fan kit  
Cat.No 0 462 70  
Supplied with earthing kit  
Grey RAL 7035

Pack	Cat.Nos	Linkeo 19" cabinets					
		Supplied in flatpack for compactness					
		Capacity	Height (mm)	Width (mm)	Depth (mm)	Net weight (kg)	Loading capacity (kg)
1	0 462 35	6 U	367	600	400	18	18
1	0 462 36	9 U	500	600	400	20	27
1	0 462 47	12 U	625	600	600	30	36
1	0 462 48	16 U	810	600	600	36	48

Pack	Cat.Nos	Linkeo 19" cabinets
1	0 462 70	<b>Fan kit</b> Kit contains: - 2 fans - 1 thermostat - ON/OFF switch Supplied with 2.3 m cable Power supply 230 V~ - 50/60 Hz

Pack	Cat.Nos	Linkeo 19" cabinets
1	6 465 01	<b>Fixed shelves</b> Screw fixing on 2 x 19" uprights Height 2 U Max. load: 15 kg Shelf depth 200 mm For cabinets depth 400 and 600 mm
1	6 465 02	Shelf depth 360 mm For cabinets depth 600 mm



Pack	Cat.Nos	Linkeo 19" cabinets
1	6 465 20	<b>1-axis 19" management panels</b> 1 U
1	6 465 21	2 U

Pack	Cat.Nos	Linkeo 19" cabinets
1	6 465 50	<b>2P+E PDU</b> 2 m cord with plug 9 French-Belgian standard sockets
1	6 465 51	8 French-Belgian standard sockets + switch
1	6 465 55	9 German standard sockets
1	6 465 56	8 German standard sockets + switch
1	6 465 60	8 British standard sockets
1	6 465 61	7 British standard sockets + switch





# 19" Bati-rack

Easy access and high-quality finish

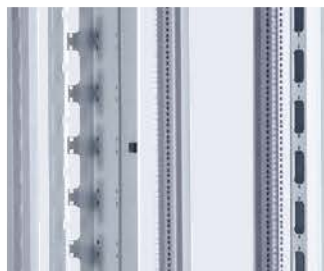

■ Full access to the wiring

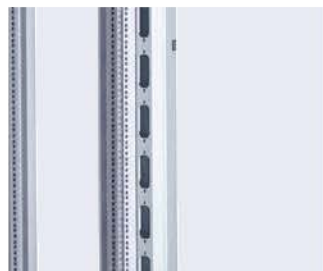

■ Takes cable management sleeves for a perfect finish



Technical characteristics p. 729

Pack	Cat.Nos	19" Bati-rack															
1	0 463 95	For housing 19" equipment in an air conditioned, secure, dust-free environment Comprises 2 or 4 x 19" uprights With levelling feet The 4-upright bati-rack takes shelves for enclosures depth 800 mm Loading capacity: 300 kg Supplied ready for assembly RAL 7035															
1	0 463 96																
		<table border="1"> <thead> <tr> <th>Capacity</th> <th>Height<sup>(1)</sup> (mm)</th> <th>Width (mm)</th> <th>Depth (mm)</th> <th>Number of uprights</th> </tr> </thead> <tbody> <tr> <td>42 U</td> <td>1965</td> <td>540</td> <td>640</td> <td>2</td> </tr> <tr> <td>42 U</td> <td>1965</td> <td>540</td> <td>820</td> <td>4</td> </tr> </tbody> </table>	Capacity	Height <sup>(1)</sup> (mm)	Width (mm)	Depth (mm)	Number of uprights	42 U	1965	540	640	2	42 U	1965	540	820	4
Capacity	Height <sup>(1)</sup> (mm)	Width (mm)	Depth (mm)	Number of uprights													
42 U	1965	540	640	2													
42 U	1965	540	820	4													
1	0 463 97	<b>Cable management sleeve</b> Closed vertical feedthrough Reversible door For fixing on the right or left on the 19" uprights RAL 7035 Sleeve															
1	0 464 98	<b>Roof</b> Roof for 4-upright bati-rack. 535 x 600 mm															
1	0 464 99	<b>Set of 4 castors</b> For bati-rack Loading capacity on the 4 castors: 340 kg															
1	6 465 01	<b>Shelves</b> Black RAL 9005 <b>Screw fixing on 2 x 19" uprights</b> Height 2 U. Max. load: 15 kg Shelf depth 200 mm Shelf depth 360 mm <b>Screw fixing on 4 x 19" uprights</b> Height 1 U Fixed shelf depth 625 mm. Max. load: 50 kg Telescopic shelf depth 625 mm. Max. load: 30 kg															
1	6 465 02																
1	6 465 06	<b>1-axis 19" management panels</b> 1 U 2 U															
1	6 465 09																
1	6 465 50	<b>2P+E PDU</b> 2 m cord with plug 9 French-Belgian standard sockets 8 French-Belgian standard sockets + switch 9 German standard sockets 8 German standard sockets + switch 8 British standard sockets 7 British standard sockets + switch															
1	6 465 51																
1	6 465 55																
1	6 465 56																
1	6 465 60																
1	6 465 61																

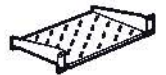

1: Without adjustment levelling feet (+ 27 to 42 mm with feet)

## Wall-mounting rack for weatherproof cabinets

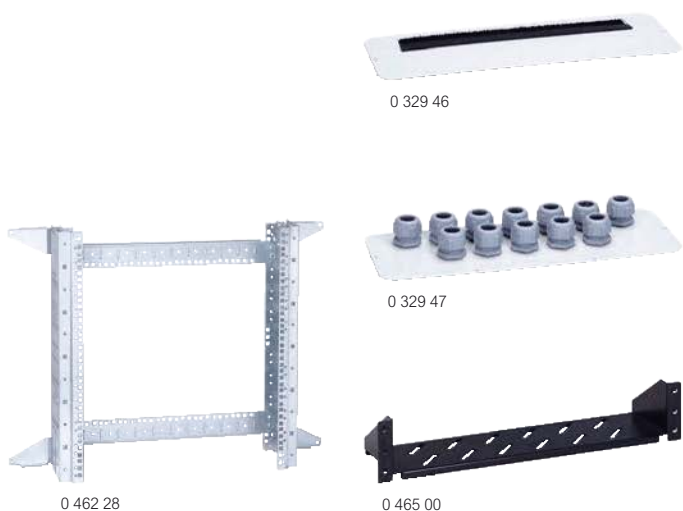

### Technical characteristics p. 729

Pack	Cat.Nos	Wall-mounting VDI rack for Atlantic and Marina cabinets
		For integrating 19" VDI equipment in Atlantic cabinets (Cat.Nos 0 355 xx) and Marina cabinets, width 600 or 800 mm and depth 250 mm min. In cabinets width 400 mm, the rack enables 10" VDI equipment to be incorporated (p. 705) Can be fixed directly on the wall to create a wall-mounted rack (without cabinet) Self-locking cable ties and cable ties with tightening indicator (see opposite) can be fitted
1	0 462 27	6 U rack
1	0 462 28	12 U rack
1	0 462 29	16 U rack

Pack	Cat.Nos	Cable entry for Atlantic cabinets width 600 or 800 mm and 19" equipment
		<b>Cable entry</b> IP 43 cable entry plate with brush (cable feedthrough 385 x 30 mm) IP 55 cable entry plate with multi-entry cable glands Supplied with 12 ISO 32 cable glands Each cable gland allows the insertion of 4 UTP/FTP/SFTP cables (Ø6.5 to 9.5 mm) Cords with connectors can be fed through without having to dismantle the cable gland Supplied with blanking plates for unused entries
1	0 329 46	IP 43 cable entry plate with brush (cable feedthrough 385 x 30 mm)
1	0 329 47	IP 55 cable entry plate with multi-entry cable glands Supplied with 12 ISO 32 cable glands Each cable gland allows the insertion of 4 UTP/FTP/SFTP cables (Ø6.5 to 9.5 mm) Cords with connectors can be fed through without having to dismantle the cable gland Supplied with blanking plates for unused entries
		<b>Fixed shelf</b> Projecting mounting on 2 x 19" uprights Fast screw-free assembly Max. load 15 kg Height 2 U Black RAL 9005 Depth 115 mm
1	0 465 00	Fixed shelf



## Altis™ 19" freestanding cabinets IP 55 - IK 10



Pack	Cat.Nos	Altis 19" 42 U cabinets																																											
		<b>Cabinets with framed glass door</b> Protection against dust, water, knocks in demanding environments - IP55 - IK10 For loads up to 720 kg on four 19" uprights Reversible door with toughened glass window 4-point locking with double bar (key barrels Cat.No 0 347 XX) Removable rear panel Cable entries at bottom (plates Cat.No 0 481 XX) Can be equipped with plinth (Cat.No 0 476 XX) 19" uprights and side panels to be ordered separately Compatible with 19" LCS <sup>2</sup> equipment (p. 702) Cat.Nos 0 331 35 and 0 464 80 can be mounted in width 800 mm cabinets (p. 701) Grey RAL 7035																																											
		<table border="1"> <thead> <tr> <th rowspan="2">Height (mm)</th> <th colspan="3">Dimensions</th> <th colspan="2">Window dim.</th> <th rowspan="2">Weight (kg)</th> </tr> <tr> <th>Width (mm)</th> <th>Depth (mm)</th> <th>Height (mm)</th> <th>Width (mm)</th> </tr> </thead> <tbody> <tr> <td>1</td> <td>0 473 62</td> <td>2000</td> <td>600</td> <td>600</td> <td>1775</td> <td>375</td> <td>91.7</td> </tr> <tr> <td>1</td> <td>0 473 63</td> <td>2000</td> <td>800</td> <td>600</td> <td>1775</td> <td>575</td> <td>110.4</td> </tr> <tr> <td>1</td> <td>0 473 91</td> <td>2000</td> <td>600</td> <td>800</td> <td>1775</td> <td>375</td> <td>95.2</td> </tr> <tr> <td>1</td> <td>0 473 92</td> <td>2000</td> <td>800</td> <td>800</td> <td>1775</td> <td>575</td> <td>114.6</td> </tr> </tbody> </table>	Height (mm)	Dimensions			Window dim.		Weight (kg)	Width (mm)	Depth (mm)	Height (mm)	Width (mm)	1	0 473 62	2000	600	600	1775	375	91.7	1	0 473 63	2000	800	600	1775	575	110.4	1	0 473 91	2000	600	800	1775	375	95.2	1	0 473 92	2000	800	800	1775	575	114.6
Height (mm)	Dimensions			Window dim.		Weight (kg)																																							
	Width (mm)	Depth (mm)	Height (mm)	Width (mm)																																									
1	0 473 62	2000	600	600	1775	375	91.7																																						
1	0 473 63	2000	800	600	1775	575	110.4																																						
1	0 473 91	2000	600	800	1775	375	95.2																																						
1	0 473 92	2000	800	800	1775	575	114.6																																						
		<b>Set of 2 side panels</b> For cabinets <table border="1"> <thead> <tr> <th>Height (mm)</th> <th>Depth (mm)</th> </tr> </thead> <tbody> <tr> <td>1</td> <td>0 472 72</td> <td>2000</td> <td>600</td> </tr> <tr> <td>1</td> <td>0 472 75</td> <td>2000</td> <td>800</td> </tr> </tbody> </table>	Height (mm)	Depth (mm)	1	0 472 72	2000	600	1	0 472 75	2000	800																																	
Height (mm)	Depth (mm)																																												
1	0 472 72	2000	600																																										
1	0 472 75	2000	800																																										
		<b>19" uprights</b> Set of 2 42 U uprights (perforations 9.5 x 9.5 mm) Supplied with mounting lugs and screws Mounting in cabinets possible width 600 or 800 mm																																											
		<b>Interior assembly kit - IP 55 for a 1000 kg/m<sup>3</sup> load</b> Set consisting of - 4 brackets - 2 joining feet - 1 gasket																																											
		<b>M 14 lifting rings</b> Set of 4 rings For a load of 1000 kg/m <sup>3</sup>																																											

## Cable ties and document holders



For grouping together and organising audio, computer, VDI, etc., cables  
Re-usable (cables can be added)

Pack	Cat.Nos	Cable ties with tightening indicator			
		Wide cable ties with patented warning system to prevent overtightening cables Release by pinching the head of the cable tie Strap held in place after tightening			
				Tightening $\varnothing$	
50	0 331 94	Width (mm)	Length (mm)	max.	min.
50	0 331 95	15	180	35	15
50	0 331 96	15	225	50	35
50	0 331 96	15	320	80	50

		Self-locking cable ties			
		Repositionable cable ties Double-sided textile with "loops" on one side and "hooks" on the other Do not damage cables Can be fixed using screws or rivets Cat.Nos 0 366 44/46 (p. 300)			
		Colour	Width (mm)	Length (mm)	Tightening $\varnothing$ max. (mm)
10	0 331 84	Black	16	150	35
10	0 331 85	Red	16	150	35
10	0 331 86	Green	16	150	35
10	0 331 87	Black	16	300	80
10	0 331 88	Red	16	300	80
10	0 331 89	Green	16	300	80

		Self adhesive base	
50	0 320 68	For cable ties max. width 20 mm Black - 38 x 38 x 9.4 mm Possible central fixing with screw $\varnothing$ 4 mm	

		Self-adhesive document holders				
		<b>Open - RAL 7035</b>				
		Ext. dimensions		Int. dimensions		
		Height (mm)	Width (mm)	Height (mm)	Width (mm)	Depth (mm)
20	0 365 80	235	340	200	310	18
20	0 365 81	165	260	130	230	18
		<b>Closed - RAL 7035</b>				
		Rigid plastic - IP 50 Int. dimensions: 324 x 120 x 18 mm				
1	0 365 82					
		<b>Transparent</b>				
10	0 097 99	Soft plastic, A4 - 305 x 220 mm				

## LCS<sup>2</sup> ZONE DISTRIBUTION BOXES

# Consolidation and redistribution made easy

Complete flexibility with the LCS<sup>2</sup> zone boxes:  
centralisation of connections close to the workstation,  
copper and fibre optics can be used together.



- Flexible installation with lines in reserve meet future requirements quickly.
- Guaranteed performance across the whole LCS<sup>2</sup> system.
- Fast, reliable connection to the LCS<sup>2</sup> zone box with sockets with copper and fibre optic feedthrough and RJ 45/RJ 45 cords.

**N** Available in cat. 6A



## Compliance of the LCS<sup>2</sup> systems with standards and certifications

LCS<sup>2</sup> systems and components (de-embedded) conform to the following standards:

- TIA/EIA 568C
- EN 50173-1 and EN 50173-2
- ISO/IEC 11801 version 2

The LCS<sup>2</sup> system supports 10G applications Base-T up to 100 m in a transmission channel. Conforms with standards ISO/IEC 24750, TIA TSB 155 and IEEE 802.3 an.

The EA link class of the LCS<sup>2</sup> system also conforms with amendment 1 (04/2008) of standard ISO 11801 and its components conform with amendment 2.

LCS<sup>2</sup> systems are certified by expert independent laboratory 3P



## Main characteristics of the LCS<sup>2</sup> systems

	LCS <sup>2</sup> 6A		LCS <sup>2</sup> 6		LCS <sup>2</sup> 5e
Frequency	500 Mhz		250 Mhz		100 Mhz
Speed	10 Gbit/s		1 Gbit/s		1 Gbit/s
Wiring	Copper	FO	Copper	FO	Copper
Connectors	RJ 45	SC-LC...	RJ 45	SC-LC...	RJ 45
Length cable max.	100 m	variable	100 m	variable	100 m

## New names for LAN cables (according to ISO 11801-2)

They correspond to: "type of cable shield" / "type of twisted pair shield" TP monitoring (for twisted pairs)

Type of cable		Shield of the cable	Shield of pairs twisted
old name	new name		
SSTP	S/FTP	S: screen made up	F: screen formed a metal braid of a ribbon alumin/polyester
SFTP	SF/UTP	SF: combination of ribbon + braid	U: no screen
STP	U/FTP	U: no screen	F: screen formed of a ribbon alumin/polyester
FTP	F/UTP	F: screen formed of a ribbon alumin/polyester	U: no screen
UTP	U/UTP	U: no screen	U: no screen

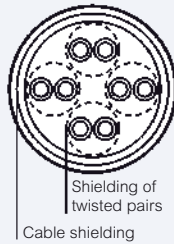

## Area distribution boxes

### Compliance with standards:

Area distribution box: TIA/EIA 568  
UTE C 15-900  
NF C 15-100 - NF C 20-730  
EN 50-174.2  
ISO 11801  
EN 50173  
IEC 60950

Cords and cables: ISO 11801 id.2.0, EN 50173-1, TIA/EIA 568

### General characteristics:

- 6 or 12 incoming ports (depending on Cat.No) RJ 45 wiring
- 4 to 8 or 12 outgoing ports (depending on Cat.No) maximum Connection of mixed cords via RJ 45 connector (RJ 45/stripped)
- UTP, FTP and STP versions
- Cat. 6A, 6 and 5e
- for computer applications; telephone, access control etc.

### Technical characteristics:

- material: Polycarbonate PC hood  
Polypropylene PP base
- colour: RAL 7035
- Weatherproofing protection index: IP 21
- Mechanical shock protection index: IK 07
- hold connector units in place in the box: 100 N
- Cables anchored on support using Colring cable ties

## Fibre optic

### New optical classes ISO 11801 2nd Ed.

#### Parameters of the optical link (ISO 11801/EN 50173)

Parameter	Multimode		Monomode	
	850 nm	1 300 nm	1 310 nm	1 550 nm
Fibre attenuation dB/km	3.5 max.	1.5 max.	1.0	1.0
Bandwidth MHz.km	200 min.	500 min.	n/a	n/a
Connector attenuation dB	0.75 max.	0.75 max.	0.75 max.	0.75 max.
Return loss dB	20 min.	20 min.	26 min.	26 min.

### Typical layout of an optical link between 2 distribution blocks

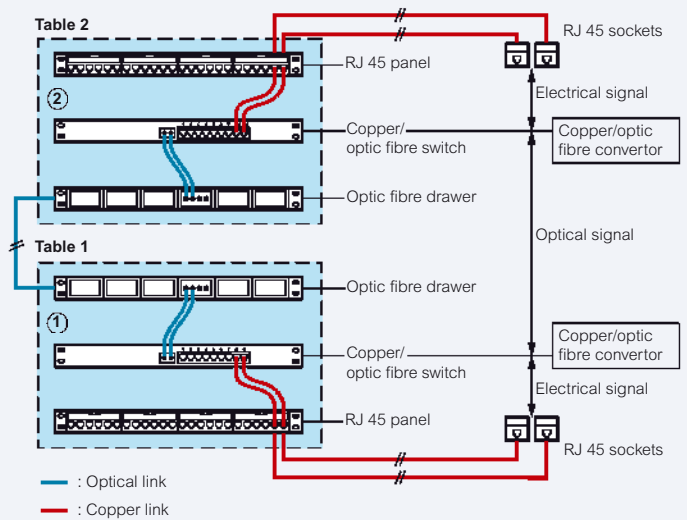

### Maximal length of channel by fibre optic application

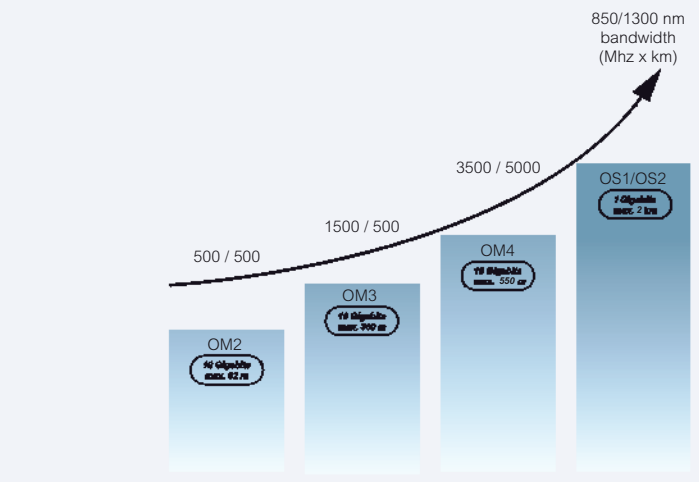

Applications	Multimode			Monomode
	OM2	OM3	OM4	OS1/OS2
10 Gigabits Ethernet (S/R base)	82 m	300 m	550 m <sup>(1)</sup>	NA
Giga Ethernet (LX base)	550 m	550 m	550 m	2 km
Giga Ethernet (SX base)	550 m	550 m	1100 m	NA

■ TIA 568

□ Applications IEEE 802.3

1: Engineered solution using a max. cabled fibre attenuation of 3.0 dB/km. If not distance is of 400 m

### Flush-mounting Ethernet 10/100 base T switches

	779 00	779 01
<b>Power supply</b>	230 V	PoE
<b>Speed</b>	100 Mbps	
<b>Standards</b>	802.3 / 802.3u	802.3u 802.3 af
<b>Common technical characteristics</b>	<ul style="list-style-type: none"> <li>Operating temperature: from 0°C to +40°C</li> <li>Max. humidity level permissible: 95 %</li> <li>Auto MDI-X (takes crossed and straight cords)</li> <li>Orange LED: - on: speed of 100 Mbps - off: speed 10 Mbps</li> <li>Green LED on traffic</li> </ul>	

### Mosaic Wi-Fi access points

#### An 802.11 a and b/g solution

	MOSAIC WiFi Access Point Cat. Nos 77913/14		LCS <sup>2</sup> Cat. Nos 335 21/22
<b>Radio communication standard</b>	802.11 b/g	802.11 a	802.11 b/g/n or 802.11 a/n
<b>Power supply standard</b>	Power over Ethernet 802.3 af		
<b>Frequency band</b>	2.4 GHz	5 GHz	2.4 GHz or 5 GHz
<b>Channel width</b>	20MHz	20MHz	40MHz or 20MHz
<b>Max. gross speed</b>	54 Mbps max	54 Mbps	300 Mbps

### Benefits of a Legrand Wi-Fi access point

- Possibility of simultaneous operation on 2 frequencies, a and b/g
- New products: invited access: used to allocate a network dedicated to visitors
- Provides a max. gross speed of up to 2 x 54 Mbps in simultaneous mode
- Very high security level: WPA2 encryption (802.11i) and authentication (802.1x)
- Possibility of roaming (moving from one access point to another without breaking the link)
- Quality of service (priority automatically given to voice, then video and finally data)
- Easy to configure and make secure: using the CD supplied with the access point

### Installation

In all supports able to take a Mosaic mechanism (trunking, columns, flush-mounting boxes, floor boxes, etc.)  
Do not place access points behind anything that could limit the antenna's range  
Access points are connected tool-free via an RJ 45 connector

### Sizing

- Provide 1 access point for 1 localised requirement (in entrance hall)
- Provide 1 access point per 100 m<sup>2</sup> for overall coverage and a maximum gross speed
- Provide 1 access point with an RJ 45 socket for a desk used by visitors

### Installation principle for a Wi-Fi access point with Power over Ethernet injector

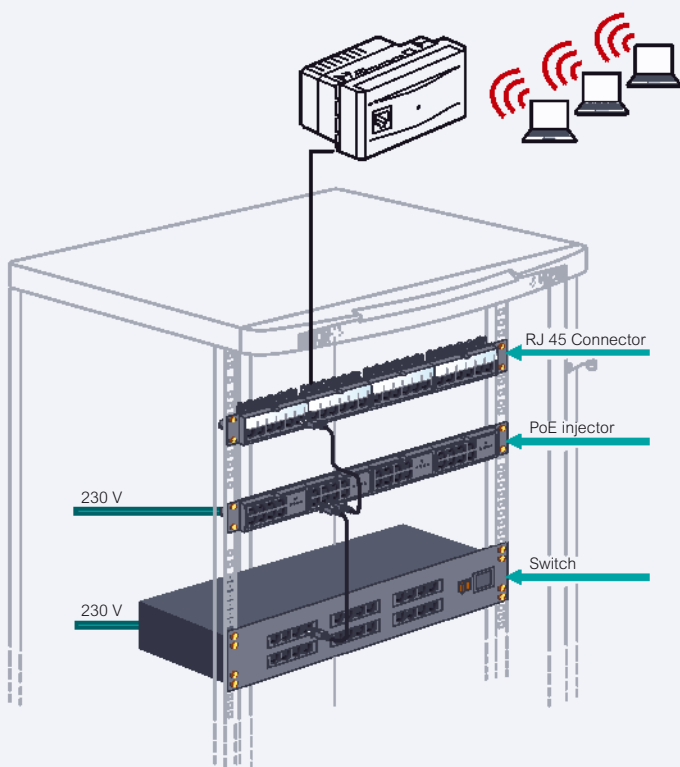

Particular case of the 1 port PoE: Clips directly onto a port on any patch panel  
A single cord is necessary to connect it to a port on the switch

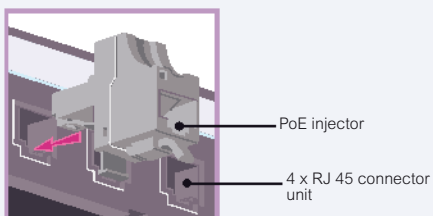

### Operation of PoE injector

A PoE injector has one input and one output per access point to be supplied

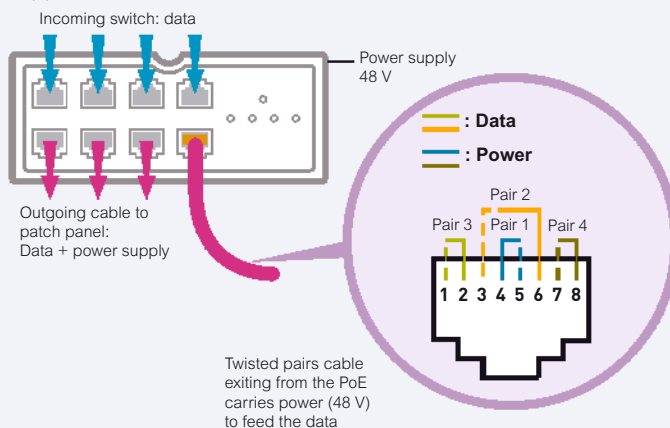

Twisted pairs cable exiting from the PoE carries power (48 V) to feed the data

# Legrand cabling system LCS<sup>2</sup>

standard and certification

## Flush-mounting Ethernet 10/100 base T switches

	0 779 00	0 779 01
Power supply	230 V	PoE
Speed	100 Mbps	
Standards	802.3 / 802.3u	802.3u 802.3 af
Common technical characteristics	<ul style="list-style-type: none"> <li>Operating temperature: from 0°C to +40°C</li> <li>Max. humidity level permissible: 95 %</li> <li>Auto MDI-X (takes crossed and straight cords)</li> <li>Orange LED: - on: speed of 100 Mbps - off: speed 10 Mbps</li> <li>Green LED on traffic</li> </ul>	

## Mosaic Wi-Fi access points

An 802.11 a and b/g/n solution

Radio communication standard	802.11 b/g	802.11 a	802.11 b/g/n or 802.11 a/n
Power supply standard Power over Ethernet	802.3 af		
Frequency band	between 2.40 and 2.48 GHz	5 GHz	2.4 GHz or 5 GHz
Number of available channels	13	8	40 MHz or 20 MHz
Max. gross speed	54 Mbps	54 Mbps	300 Mbps

## Benefits of a Legrand Wi-Fi access point

- Possibility of simultaneous operation on 2 frequencies, a and b/g
- New products: invited access: used to allocate a network dedicated to visitors
- Provides a max. gross speed of up to 2 x 54 Mbps in simultaneous mode
- Very high security level: WPA2 encryption (802.11i) and authentication (802.1x)
- Possibility of roaming (moving from one access point to another without breaking the link)
- Quality of service (priority automatically given to voice, then video and finally data)
- Easy to configure and make secure: using the CD supplied with the access point

## Installation

In all supports able to take a Mosaic mechanism (trunking, columns, flush-mounting boxes, floor boxes, etc.)  
Do not place access points behind anything that could limit the antenna's range  
Access points are connected tool-free via an RJ 45 connector

## Sizing

- provide 1 access point for 1 localised requirement (in entrance hall)
- provide 1 access point per 100 m<sup>2</sup> for overall coverage and a maximum gross speed
- provide 1 access point with an RJ 45 socket for a desk used by visitors

## Installation principle for a Wi-Fi access point with Power over Ethernet injector

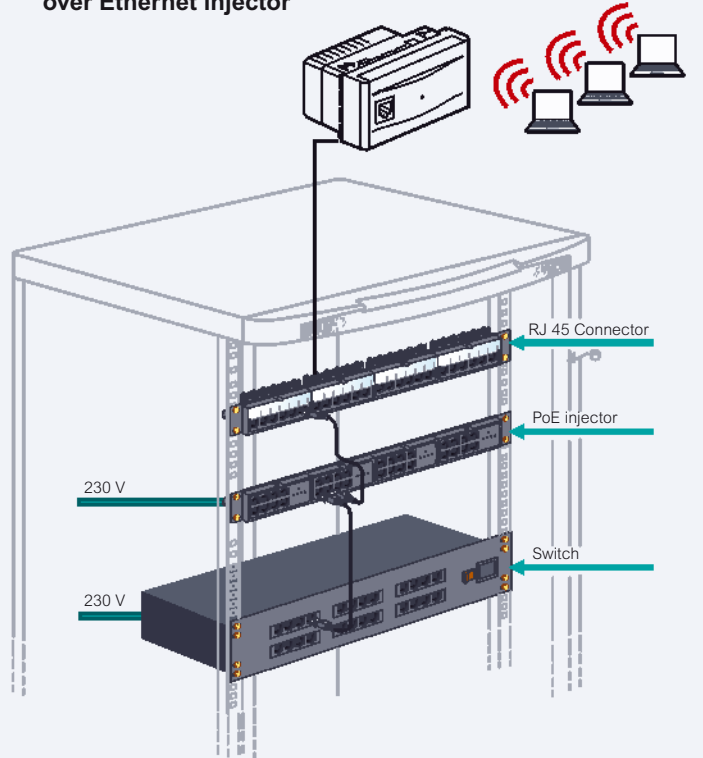

Particular case of the 1 port PoE: Clips directly onto a port on any patch panel  
A single cord is necessary to connect it to a port on the switch

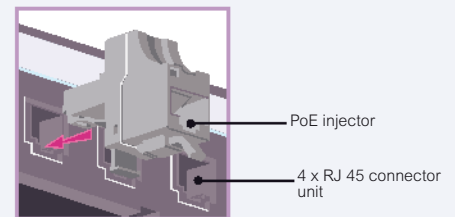

## Operation of PoE injector

A PoE injector has one input and one output per access point to be supplied

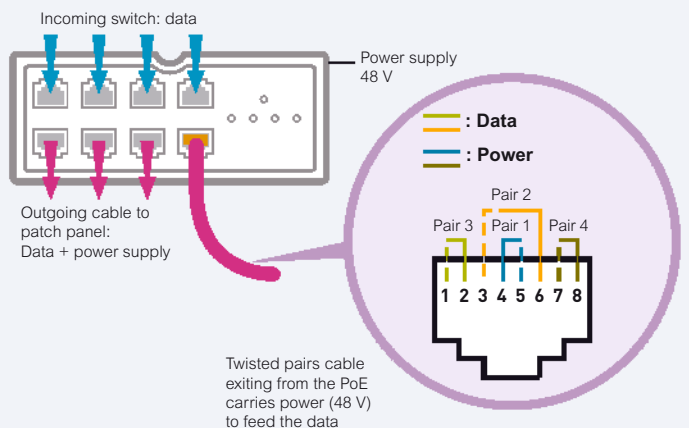

## Legrand services

The Relations Pro<sup>(1)</sup> service will work with you and guide you in setting up your VDI sites:

- help with sizing the installation
- on-site assistance for integrating products and making important installations secure

Advisors are also available to answer all your technical questions

1 : 0810 48 48 48 (local call rate) Monday to Friday 0800 to 1800

# Legrand cabling system LCS<sup>2</sup>

## LCS<sup>2</sup> 19" cabling and server freestanding cabinets

### General characteristics

Metallic extendable cabinets. RAL 7016 textured polyester coating providing excellent resistance to corrosion and scratching  
 Front glass safety door, front and rear microperforated metal doors for server cabinets  
 Protection index (weatherproof) against solid objects and liquids: IP 20. Protection index against mechanical shocks: IK 08  
 Perforations in 19" uprights: 9.5 x 9.5 mm  
 Loading capacity: 420 kg for cabling cabinet  
 630 kg for server cabinet

### Compliance with standards

LCS<sup>2</sup> cabinets comply with the following standards:

<b>IEC 60529</b> <b>EN 60529</b>	(NF C 20-010) Degrees of protection provided by enclosures (IP code)
<b>IEC 62262</b> <b>EN 62262</b>	(NF EN 50102, NF C 20-015) Degree of protection provided by enclosures of electrical equipment against external mechanical impacts (IK code)
<b>IEC 60950-1</b> <b>EN 60950-1</b> <b>C 77-210-1</b>	Safety of data processing equipment
<b>EIA-310-E</b>	Cabinets, enclosures, panels and associated equipment (ANSI/EIA/310-E-2005)
<b>IEC 60297-3-100</b> <b>DIN 41414-7</b>	(NF C 20-150, NF C 20-151) Sizes of mechanical structures of the 482.6 mm (19 in) series

LCS<sup>2</sup> cabinets can be integrated into installations complying with the following standards:

<b>EN 50173-1</b>	Information technology - Generic cabling systems
<b>EN 50174-1 &amp; 2</b> <b>C 90-480-1 &amp; 2</b>	Information technology - Cabling installation
<b>ISO IEC 11801</b>	Information technology - Generic cabling for customer premises
<b>NF C 15-100</b> <b>Part 4-41</b>	Low voltage electrical installations - Recommendations
<b>IEC 60364-4-41</b>	Low voltage electrical installations - Protection for safety - Protection against electric shock

### Overall dimensions (mm)

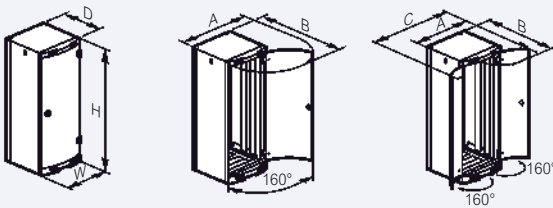

#### Front single door

Cat.Nos	Capacity	H <sup>(1)</sup>	W	D	A	B
0 463 00	24 U	1226	610	659	1138	1208
0 463 06	29 U	1448				
0 463 12	33 U	1626				
0 463 18/30	42 U	2026	810	859	1525	1408
0 463 19				657		
0 463 21				657		
0 463 22/33				857		
0 463 23				1057		
0 463 28	47 U	2248	857	1608	1808	
0 463 29			1057	1608	1808	

#### Front double door

Cat.Nos	Capacity	H <sup>(1)</sup>	W	D	A	B	C
0 463 41	42 U	2026	810	657	1165	815	1535
0 463 42				857		1015	
0 463 43				1057		1215	

#### Server cabinets

Cat.Nos	Capacity	H <sup>(1)</sup>	W	D	A	B
0 463 85	42 U	2026	610	1086	1160	1655
0 463 86	42 U	2026	810	1096	1550	1858

1 : Without adjustment levelling feet (+ 15 to 45 mm with feet)

### Useable dimensions

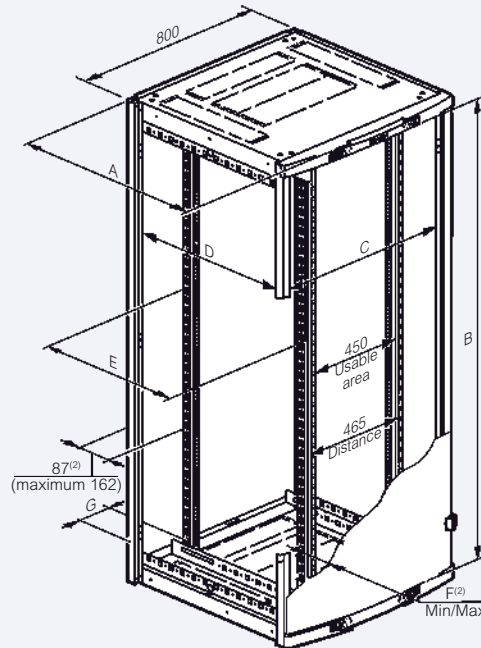
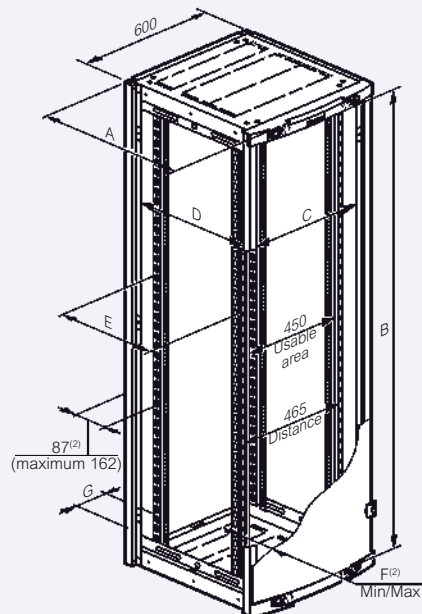

2 : Continuous adjustment with adjustments in widths of 12.5 mm

#### Front single door

Cat.Nos	Capacity	A	Usable area			E	F <sup>(2)</sup>		G
			B	C	D		Min.	Max.	
0 463 00	24 U	659	1086	490	490	425	118	193	41
0 463 06	29 U		1308						
0 463 12	33 U		1486						
0 463 18/30	42 U	859	1886	690	625	122	197	141	
0 463 19		857							
0 463 21		857							
0 463 22/33		1057							
0 463 23		1057							
0 463 28	47 U	857	2108	690	625	122	197	141	
0 463 29		1057							890

#### Front double door

Cat.Nos	Capacity	A	Usable area			E	F <sup>(2)</sup>		G
			B	C	D		Min.	Max.	
0 463 41	42 U	657	1886	690	490	425	122	197	141
0 463 42		857							
0 463 43		1057							

#### Server cabinets

Cat.Nos	Capacity	A	Usable area			E	F <sup>(2)</sup>		G
			B	C	D		Min.	Max.	
0 463 85	42 U	1086	1886	490	890	825	75	150	41
0 463 86		1096							

# Legrand cabling system LCS<sup>2</sup>

## LCS<sup>2</sup> 19" cabling and server freestanding cabinets and accessories

### LCS<sup>2</sup> cabling cabinets cable entries (mm)

Pre-cut at the top and bottom in 19" format (useable area 451 mm)

	Width 600	Width 800
Depth 600		
Depth 800		
Depth 1000		

### LCS<sup>2</sup> server cabinets cable entries (mm)

Pre-cut at the top in 19" format (useable area 451 mm)  
Bottom central cut (805 x 450 mm)

	Top	Bottom
Width 600		
Width 800		

### Weight cabling cabinets (kg)

Weights shown correspond to net weight (without packaging)

Cat.Nos	Weight Cabinet	Weight Extension cabinet
0 463 00	69	-
0 463 06	77	-
0 463 12	84	-
0 463 18/30 (ext)	99	72
0 463 19	110	-
0 463 21	114	-
0 463 22/33 (ext)	127	90
0 463 23	151	-
0 463 28	138	-
0 463 29	163	-
0 463 41	114	-
0 463 42	127	-
0 463 43	151	-

### Weight server cabinets (kg)

Weights shown correspond to net weight (without packaging)

Cat.Nos	Weight Cabinet
0 463 85	155
0 463 86	166

### Cabinet plinths (mm)

Base kit + side traps

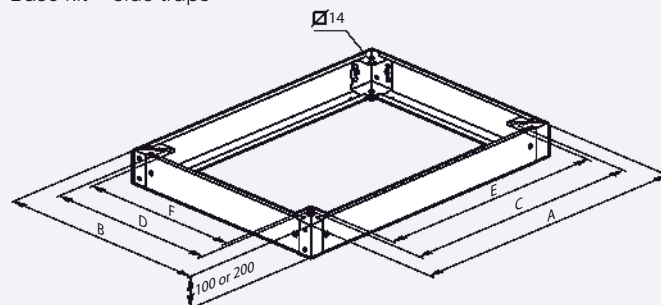

Cabinet dim. Width x Depth	Overall		Mounting		Usable area	
	A	B	C	D	E	F
600 x 600	599	599	478	478	449	449
600 x 800	599	799	478	678	449	649
800 x 600	799	599	678	478	649	449
800 x 800	799	799	678	678	649	649
600 x 1000	599	999	478	878	449	849
800 x 1000	799	999	678	878	649	849

### Linking interface (mm)

Left or right assembly of a cabinet fitted with a 200 mm high base  
Reversible interface cover

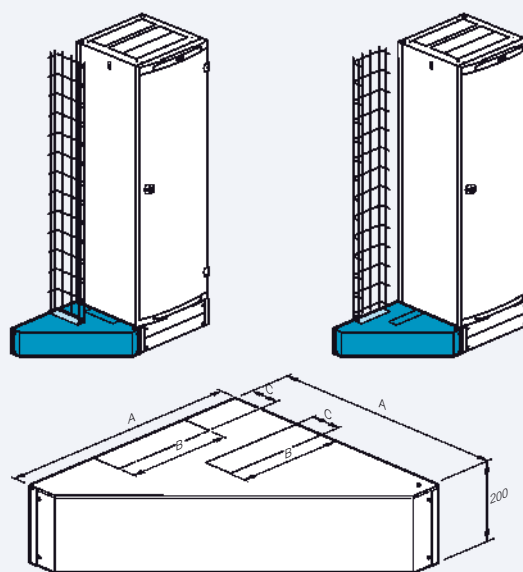

Cabinet dim. Depth	A	B	C
600	595	435	120



# Legrand cabling system LCS<sup>2</sup>

LCS<sup>2</sup> cabling and server cabinets accessories

## Adjustable height plinths

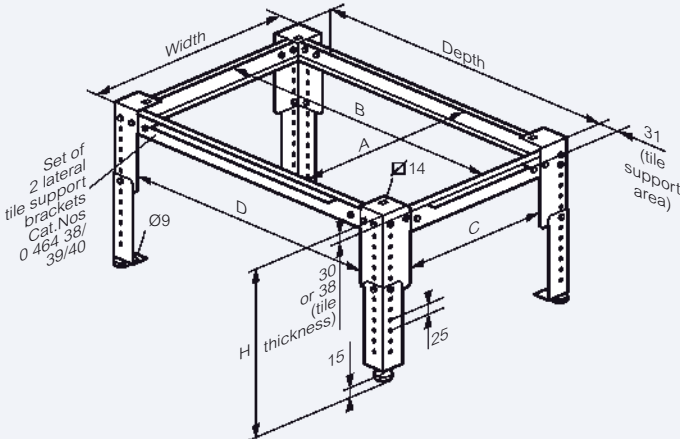
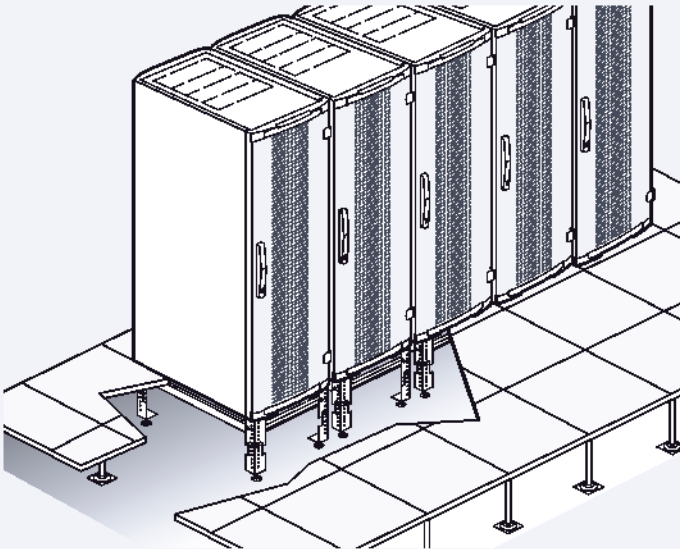

Cat.Nos	Width x Depth	H <sup>(1)</sup>		Usable area				Distance (width x depth)	
		Min.	Max.	A	B	C	D	With cabinet	To the ground
0 464 30	600 x 600	200	350	530	730	435	435	478 x 478	520 x 520
0 464 31	600 x 800			930	635	478 x 678	520 x 720		
0 464 32	600 x 1000			835	478 x 878	520 x 920			
0 464 33	800 x 600			530	435	678 x 478	720 x 520		
0 464 34	800 x 800			730	635	678 x 678	720 x 720		
0 464 35	800 x 1000			930	835	678 x 878	720 x 920		

1: Ajustable au pas de 25 mm + réglage fin

## Supports for cable guides on server cabinets

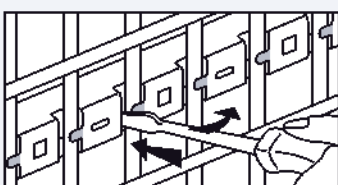
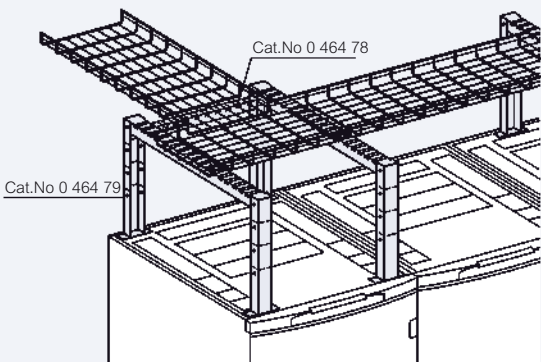

Cable guides can be installed quickly on the supports  
Cat.Nos 0 464 72/73/74/78/79

## 19" plates with fans (mm)

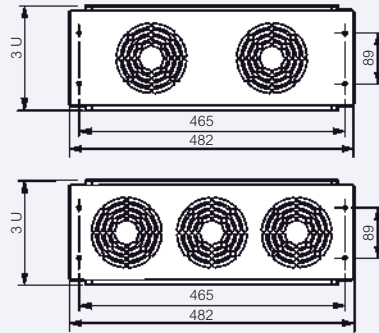

Cat.Nos	Ventilation zone	
	Number of fans	Output (m <sup>3</sup> /h)
0 464 87	2	180
0 464 88	3	270

## Shelves (mm)

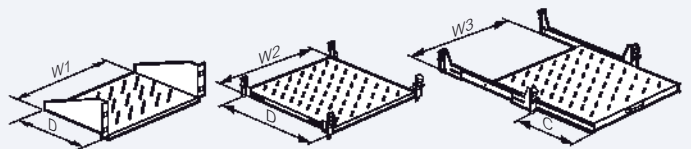

Cat.Nos	D	Useable width			C
		W1	W2	W3	
0 462 23 <sup>(1)</sup>	120	216			
0 465 00	115	435			
0 465 01	200	435			
0 465 02	360	435			
0 465 05	425		440		
0 465 06	625		440		
0 465 07	825		440		
0 465 08	425			425	320
0 465 09	625			425	420
0 465 10	625			425	420
0 465 17	820		425		
0 465 18	820			380	650

1: Fixing centre 236.5 mm

## Keyboard support shelf (mm)

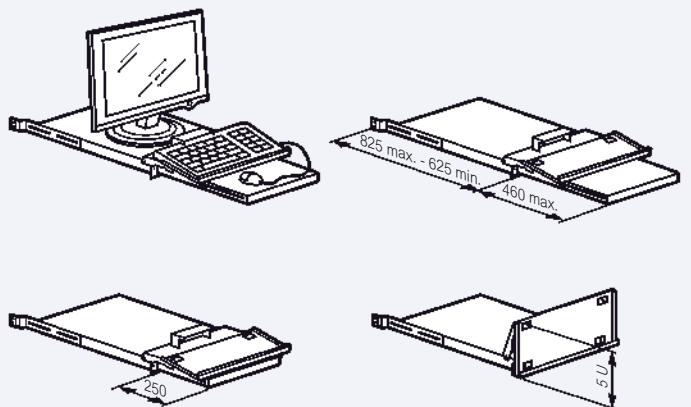

# Legrand cabling system

## 19" racks and accessories

### PDU support

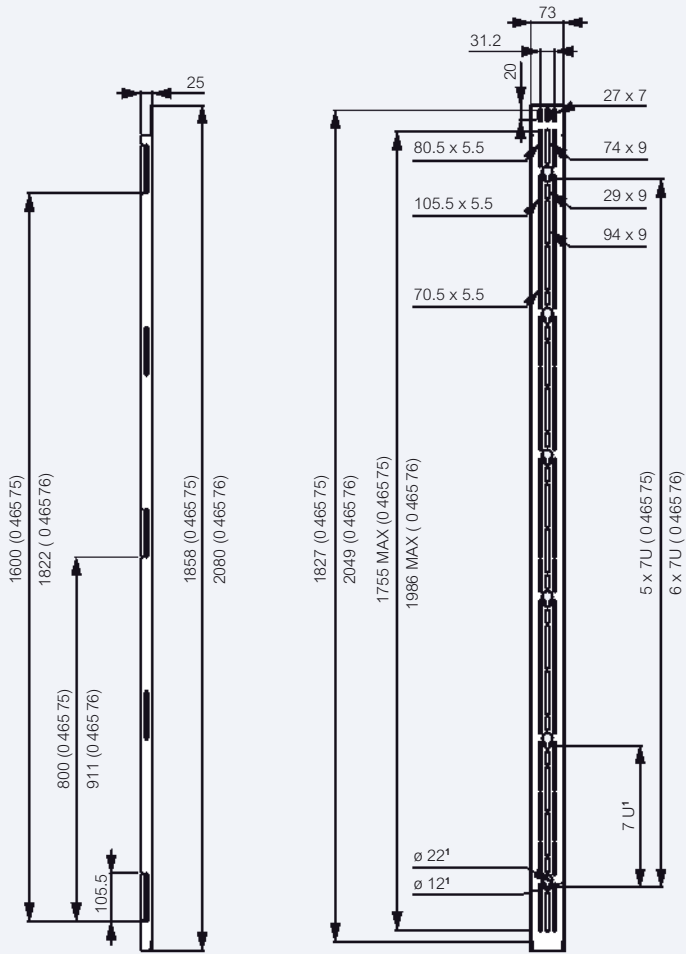

1: For mounting of PDU with button

### 19" Racks

Permissible load: 15 kg/U

0 464 06

0 464 07

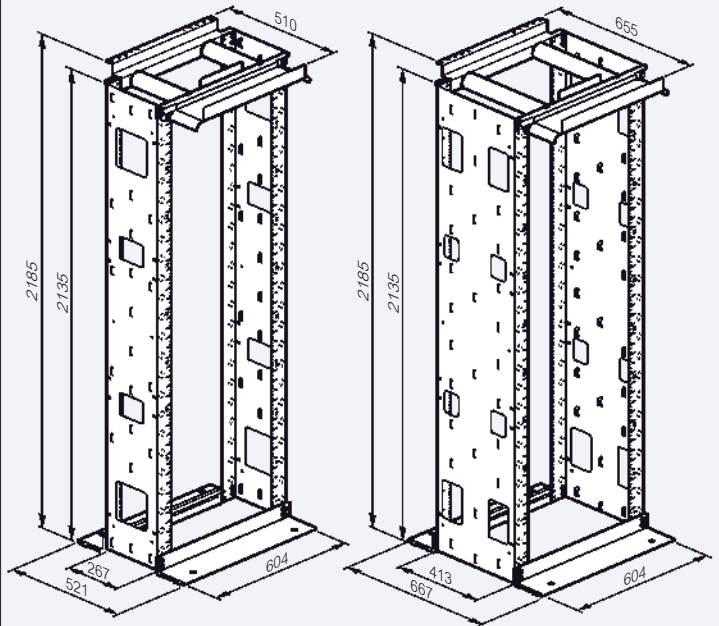

### Cord management grids

0 464 25

0 464 26

0 464 27

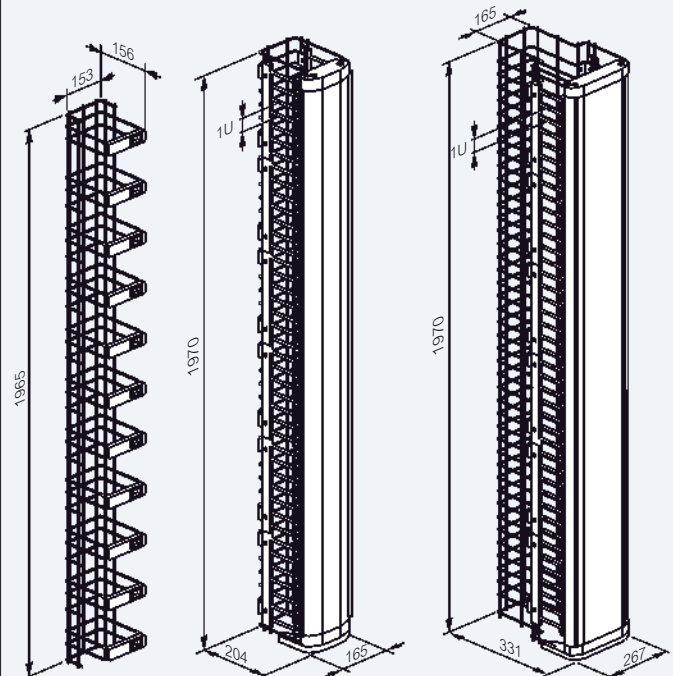

■ 0 464 25

**Swing latch replacement installation**

Installation can be either right or left hand swing out

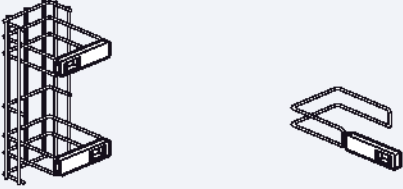

■ 0 464 26/27

**Bend limiting clips**

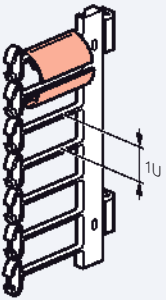

**Cord coiling support**

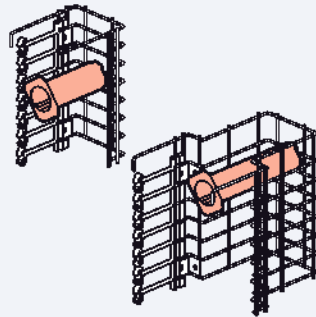

■ **Joining racks with grid**

0 464 25/26

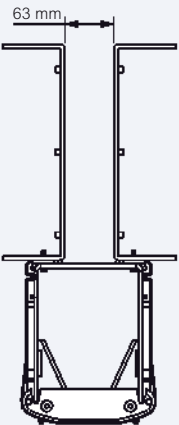

0 464 27

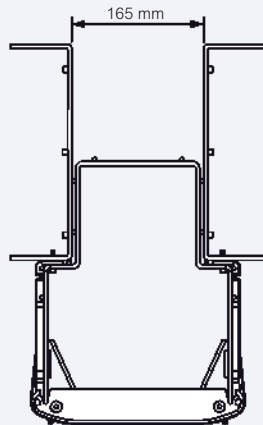

■ **Cable tray support**

0 464 18/19

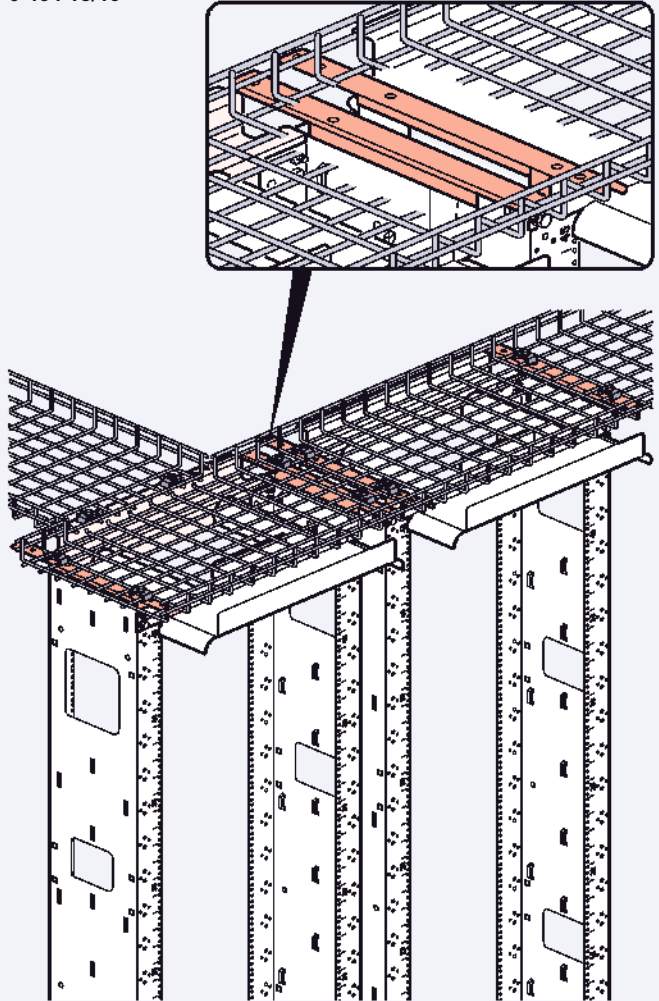

■ **19" cord management panels**

0 465 70/71

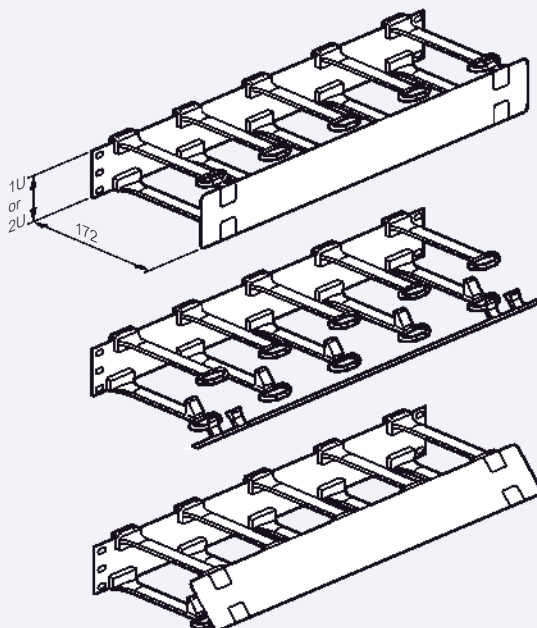

# Legrand cabling system LCS<sup>2</sup>

## 19" and 10" LCS<sup>2</sup> wall-mounting cabinets

### General characteristics

Metallic wall-mounting cabinets  
 RAL 7016 textured polyester coating providing excellent resistance to corrosion and scratching  
 Front safety glass door  
 Protection index (weatherproof) against solid objects and liquids: IP 20  
 Protection index against mechanical shocks: IK 08  
 Perforations in uprights: 9.5 x 9.5 mm  
 Permissible load: 3 kg/U (or 48 kg for a 19" cabinet 16 U)  
 12 kg for the 10" cabinet 6 U

### Compliance with standards

LCS<sup>2</sup> cabinets comply with the following standards:

<b>IEC 60529</b> <b>EN 60529</b>	(NF C 20-010) Degrees of protection provided by enclosures (IP code).
<b>IEC 62262</b> <b>EN 62262</b>	(EN 50102, NF C 20-015) Degrees of protection provided by enclosures of electrical material against external mechanical impacts (IK code).
<b>IEC 60950-1</b> <b>EN 60950-1</b> <b>C 77-210-1</b>	Safety of data processing equipment.
<b>EIA-310-E</b>	Cabinets, enclosures, panels and associated equipment (ANSI / EIA / 310-E-2005).
<b>IEC 60297-3-100</b> <b>DIN 41414-7</b>	(NF C 20-150, NF C 20-151) Sizes of mechanical structures of the 482.6 mm (19 in) series

LCS<sup>2</sup> cabinets can be integrated into installations complying with the following standards:

<b>EN 50173-1</b>	Information technology - Generic cabling systems.
<b>EN 50174-1 &amp; 2</b> <b>C 90-480-1 &amp; 2</b>	Information technology - Cabling installation.
<b>ISO IEC 11801</b>	Information technology - Generic cabling for customer premises
<b>NF C 15-100</b> <b>Part 4-41</b>	Low voltage electrical installations - Recommendations.
<b>UTE C90-483</b>	Residential cabling for communication networks
<b>IEC 60364-4-41</b>	Low voltage electrical installations - Protection for safety - Protection against electric shock

### Overall dimensions (mm)

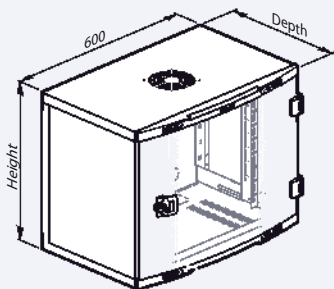

	Cat.Nos	Capacity	Height	Width	Depth
Fixed 19" cabinets	0 462 00	6 U	350	600	400
	0 462 01	9 U	500		
	0 462 02	12 U	600		
	0 462 03	16 U	800		
	0 462 06	9 U	500		580
	0 462 07	12 U	600		
	0 462 08	16 U	800		
	0 462 09	21 U	1000		
19" pivoting cabinets	0 462 11	9 U	500	600	615
	0 462 12	12 U	600		
	0 462 13	16 U	800		
	0 462 14	21 U	1000		
10" cabinet	0 462 20	6 U	352	314	300

### Pivoting bottom opening

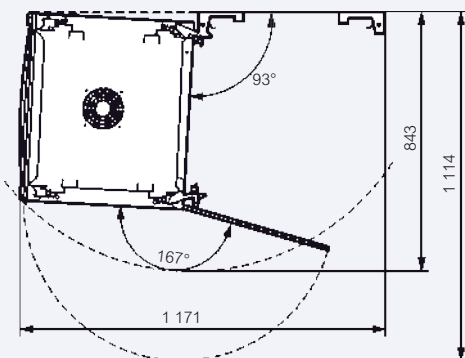

### Front opening door and side panels

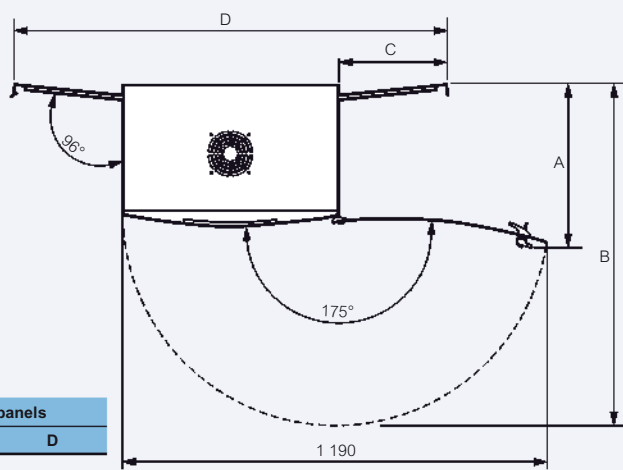

	Cat.Nos	Open doors		Open panels	
		A	B	C	D
Fixed 19" cabinets	0 462 00	400	962	305	1205
	0 462 01				
	0 462 02				
	0 462 03				
	0 462 06	580	1140	482.5	1565
	0 462 07				
	0 462 08				
	0 462 09				
19" pivoting cabinets	0 462 11	600	1179	482.5	1565
	0 462 12				
	0 462 13				
	0 462 14				

### 10" cabinet door opening Cat.No 0 462 20

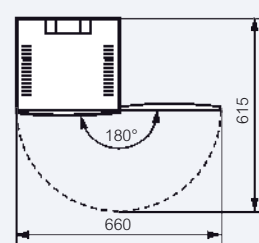

# Legrand cabling system LCS<sup>2</sup>

## 19" and 10" LCS<sup>2</sup> wall-mounting cabinets

### Useable dimensions (mm)

#### Fixed 19" LCS<sup>2</sup> cabinets depth 400 mm

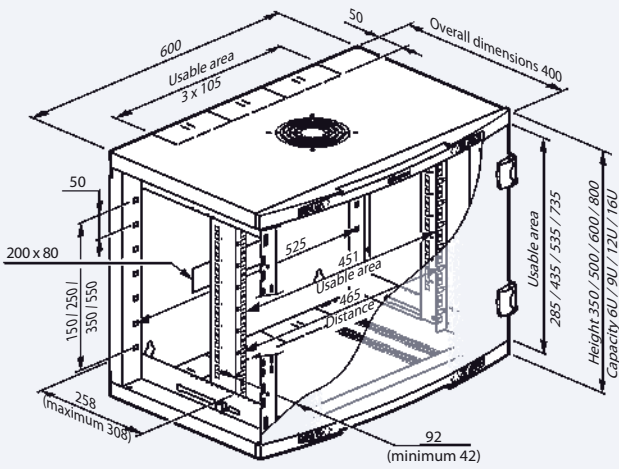

#### Fixed 19" LCS<sup>2</sup> cabinets depth 580 mm

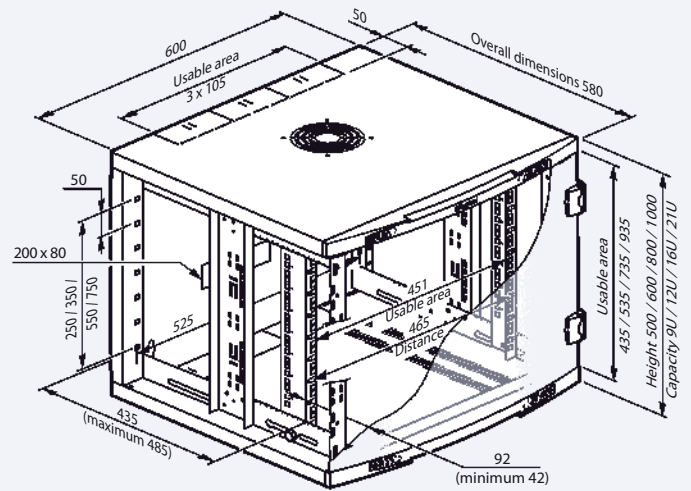

#### Pivoting 19" LCS<sup>2</sup> cabinets depth 600 mm

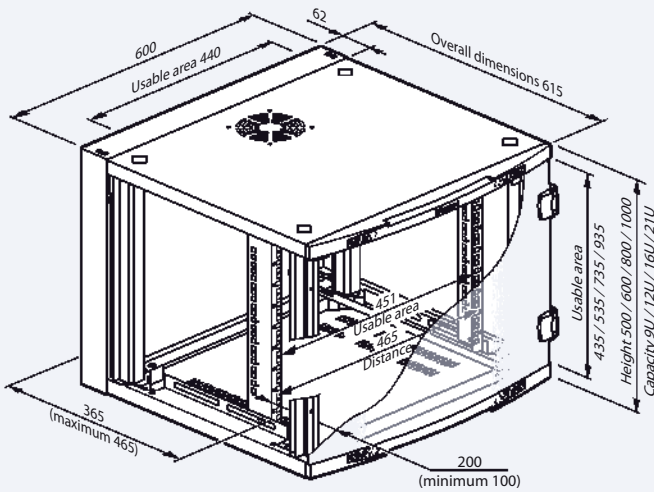

#### 10" LCS<sup>2</sup> cabinet depth 300 mm

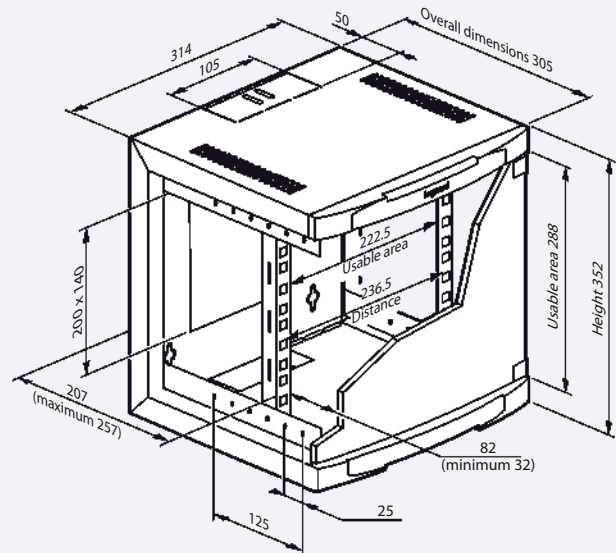

### Fixing of cabinets (mm)

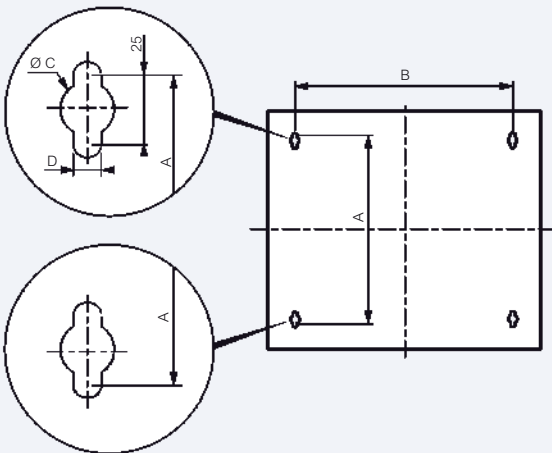

	Capacity	A	B	C	D
Fixed 19" cabinets	6 U	275	408	20	11
	9 U	425			
	12 U	525			
	16 U	725			
	21 U	925			
19" pivoting cabinets	9 U	425	500	18	9
	12 U	525			
	16 U	725			
10" cabinets	6 U	275	250	15	6.5

### Weight (kg)

	Cat.Nos	Weight
Fixed 19" cabinets	0 462 00	16.7
	0 462 01	20.4
	0 462 02	22.8
	0 462 03	26
	0 462 06	25.7
	0 462 07	32.7
	0 462 08	41.5
	0 462 09	52.5
	0 462 11	31.8
19" pivoting cabinets	0 462 12	40
	0 462 13	47.3
	0 462 14	59
10" cabinet	0 462 20	8

# Energy distribution

## vertical Power Distribution Units (PDU)

### Vertical Power Distribution Units configuration

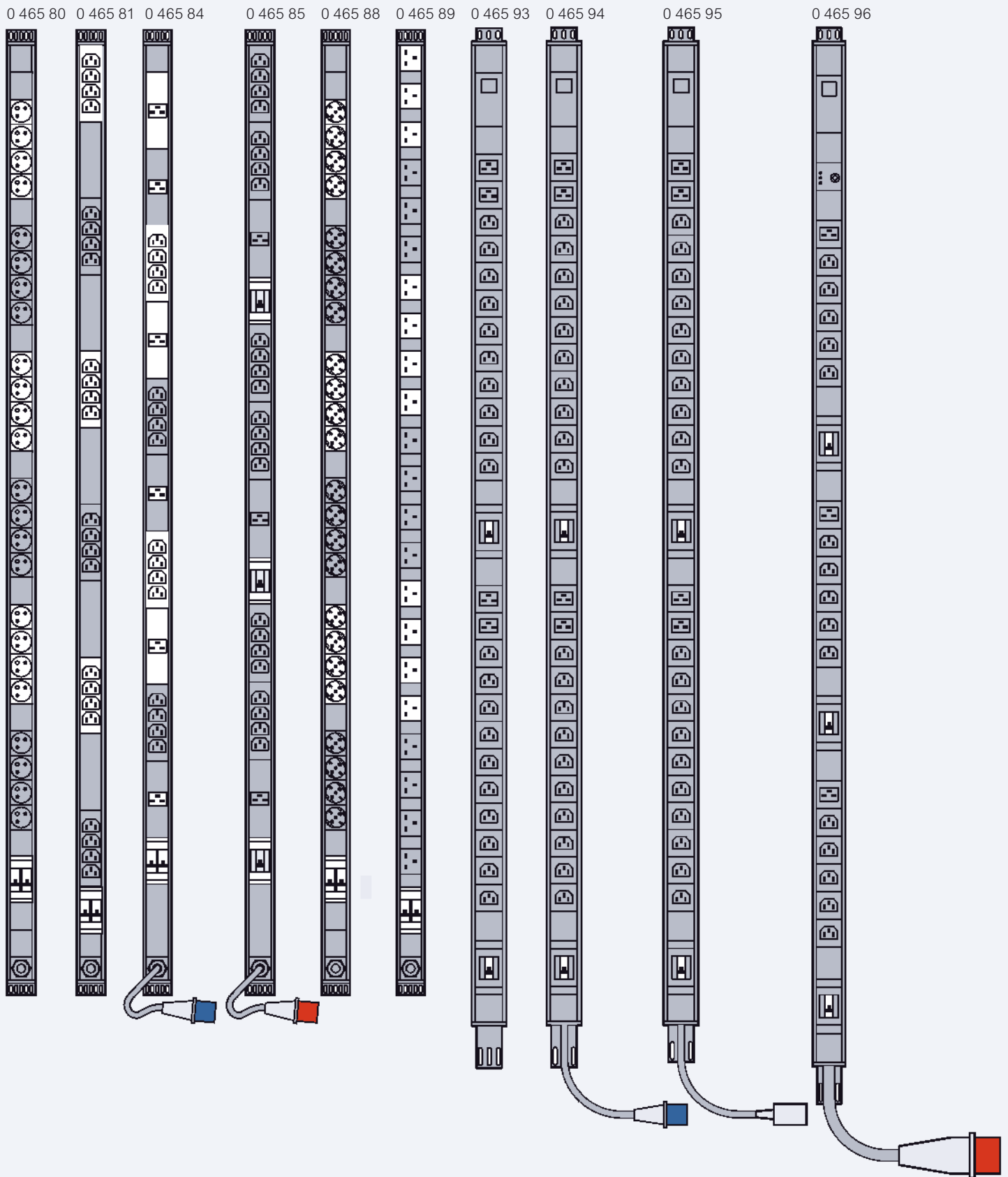

■ Mounting in LCS<sup>2</sup> cabling and server cabinets

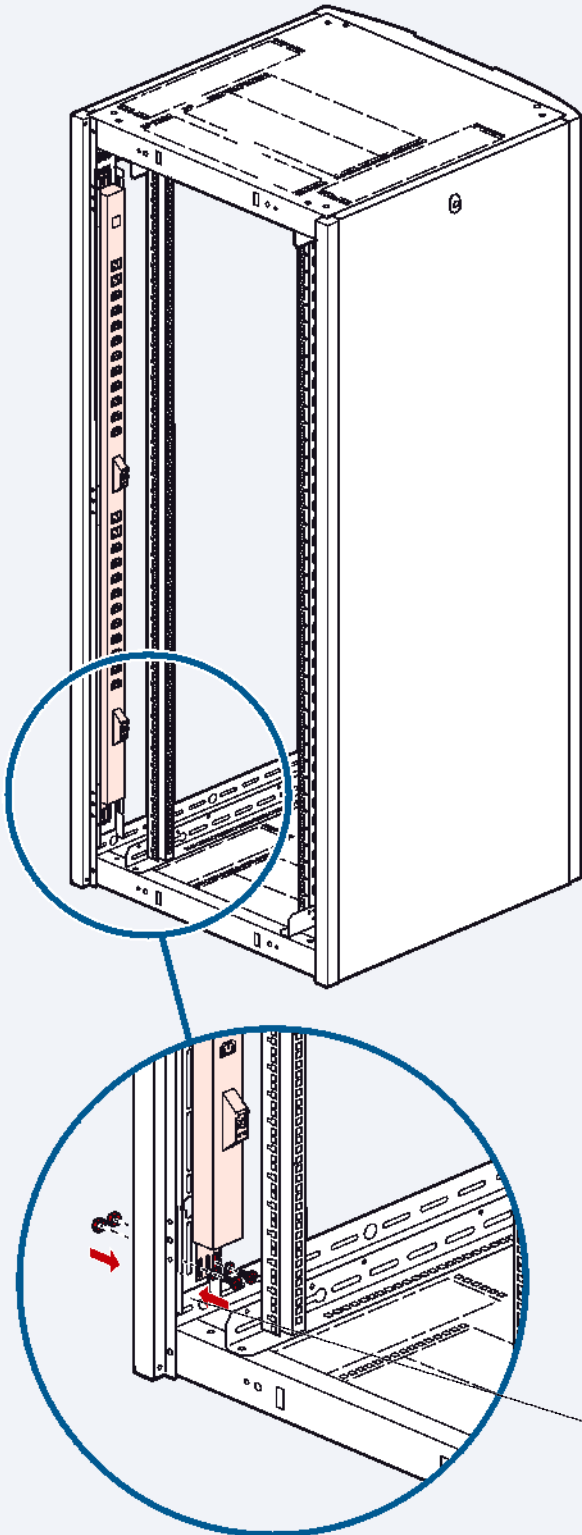

Mounting in cabling and server cabinets with a PDU support  
Cat.No 0 465 75/76 (p. 701)

# Linkeo 19" freestanding cabinets

## General characteristics

Metallic extendable freestanding cabinets  
 RAL 7035 textured polyester coating providing excellent resistance to corrosion and scratching  
 Front door with safety glass window  
 Protection index (weatherproof) against solid objects and liquids: IP 20  
 Protection index against mechanical impacts: IK 08  
 Perforations in 19" uprights: 9.5 x 9.5 mm  
 Permissible load: 400 kg

## Compliance with standards

Linkeo cabinets comply with the following standards:

<b>IEC 60529</b> <b>EN 60529</b>	(NF C 20-010) Degrees of protection provided by enclosures (IP code)
<b>IEC 62262</b> <b>EN 62262</b>	(NF EN 50102, NF C 20-015) Degrees of protection provided by enclosures for electrical equipment against external mechanical impacts (IK code)
<b>IEC 60950-1</b> <b>EN 60950-1</b> <b>C 77-210-1</b>	Safety of data processing equipment
<b>EIA-310-E</b>	Cabinets, racks, panels and associated equipment (ANSI/EIA/310-E-2005)
<b>IEC 60297-3-100</b> <b>DIN 41414-7</b>	(NF C 20-150, NF C 20-151) Dimensions of mechanical structures of the 482.6 mm (19 in) series
<b>IEC 60364-4-41</b>	Low voltage electrical installations - Protection for safety - Protection against electric shock

Linkeo cabinets can be integrated in installations complying with the following standards:

<b>EN 50173-1</b>	Information technology - Generic cabling systems
<b>EN 50174-1 &amp; 2</b> <b>C 90-480-1 &amp; 2</b>	Information technology - Cabling installation
<b>ISO IEC 11801</b>	Information technology - Generic cabling for customer premises
<b>NF C 15-100</b> <b>Part 4-41</b>	Low voltage electrical installations - recommendations
<b>IEC 60364-4-41</b>	Low voltage electrical installations - Protection for safety - Protection against electric shock

## Dimensions (mm)

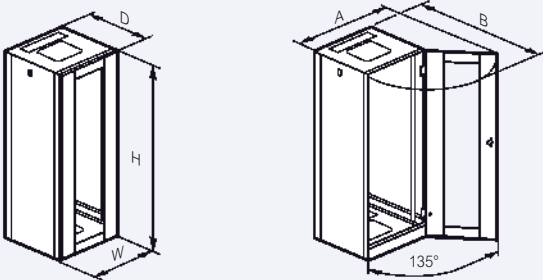

Cabinet dimensions	Overall dimensions				
	H <sup>(1)</sup>	W	D	A	B
<b>24 U 600 x 600</b>	1226	610	630	1015	1210
<b>24 U 600 x 800</b>		610	830	1015	1410
<b>24 U 800 x 600</b>		810	630	1355	1410
<b>24 U 800 x 800</b>		810	830	1355	1610
<b>33 U 600 x 600</b>	1626	610	630	1015	1210
<b>33 U 600 x 800</b>		610	830	1015	1410
<b>33 U 800 x 600</b>		810	630	1355	1410
<b>33 U 800 x 800</b>		810	830	1355	1610
<b>42 U 600 x 600</b>	2026	610	630	1015	1210
<b>42 U 600 x 800</b>		610	830	1015	1410
<b>42 U 600 x 1000</b>		610	1030	1015	1610
<b>42 U 800 x 600</b>		810	630	1355	1410
<b>42 U 800 x 800</b>		810	830	1355	1610
<b>42 U 800 x 1000</b>		810	1030	1355	1810

1: Without adjustment levelling feet (+15 to 45 mm with feet)

## Useable dimensions (mm)

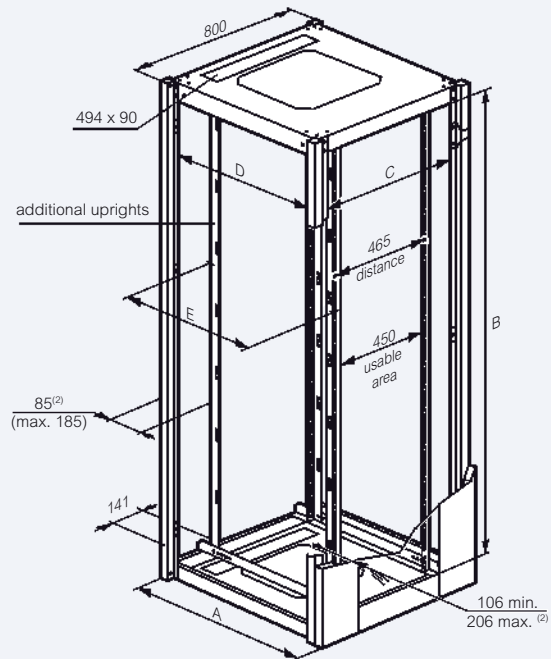
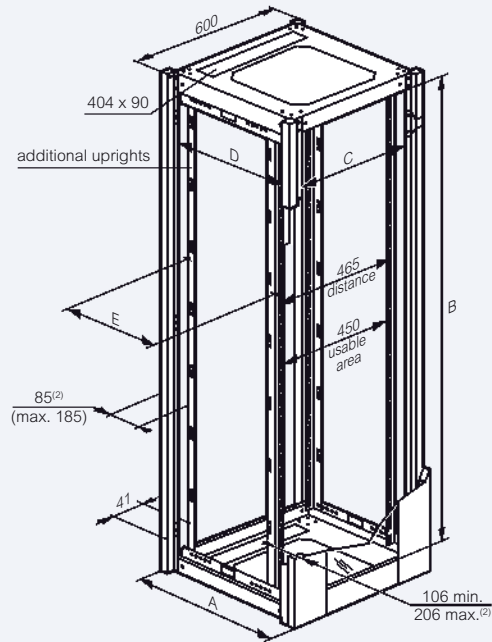

Cabinet dimensions	A <sup>(1)</sup>	Usable area			E	Glass window Door
		B	C	D		
<b>24 U 600 x 600</b>	630	1086	490	490	425	1073 x 360
<b>24 U 600 x 800</b>	830		490	690	625	1073 x 360
<b>24 U 800 x 600</b>	630		690	490	425	1073 x 450
<b>24 U 800 x 800</b>	830		690	690	625	1073 x 450
<b>33 U 600 x 600</b>	630	1486	490	490	425	1473 x 360
<b>33 U 600 x 800</b>	830		490	690	625	1473 x 360
<b>33 U 800 x 600</b>	630		690	490	425	1473 x 450
<b>33 U 800 x 800</b>	830		690	690	625	1473 x 450
<b>42 U 600 x 600</b>	630	1886	490	490	425	1873 x 360
<b>42 U 600 x 800</b>	830			690	625	
<b>42 U 600 x 1000</b>	1030		890	825		
<b>42 U 800 x 600</b>	630		690	490	425	1873 x 450
<b>42 U 800 x 800</b>	830			690	625	
<b>42 U 800 x 1000</b>	1030		890	825		

1: Overall dimensions

2: Can be adjusted in 25 mm steps



### Plinths for Linkeo cabinets (mm)

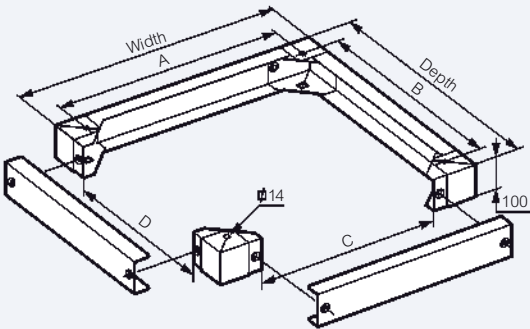

Cab. dimensions Width x Depth	Overall		Fixing		Usable area	
	Width	Depth	A	B	C	D
600 x 600	600	600	478	478	336	336
600 x 800	600	800	478	678	336	536
600 x 1000	600	1000	478	878	336	736
800 x 600	800	600	678	478	536	336
800 x 800	800	800	678	678	536	536
800 x 1000	800	1000	678	878	536	736

### Linkeo fan kits (mm)

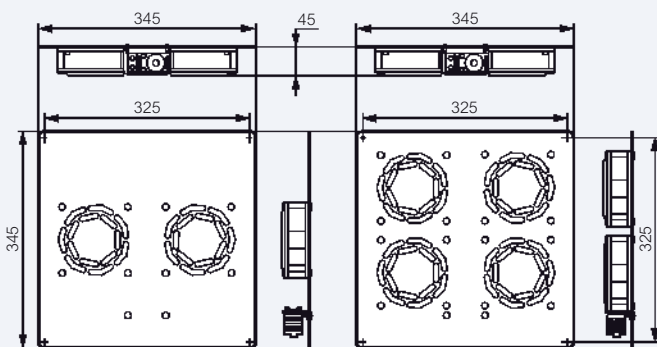

### Linkeo shelves (mm)

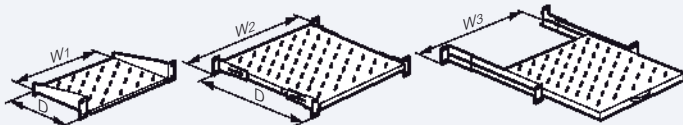

Cat.Nos	D	Useable width		
		W1	W2	W3
6 465 01	200	435		
6 465 02	360	435		
6 465 05	425		440	
6 465 06	625		440	
6 465 07	825		440	
6 465 08	425			410
6 465 09	625			410
6 465 10	825			410

### Linkeo vertical cable guides

33 U guide: 1486 x 300 x 25 mm  
42 U guide: 1886 x 300 x 25 mm

Side mounting

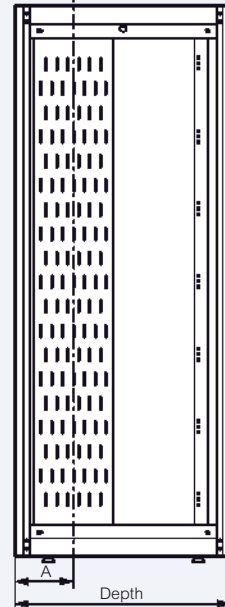

Cabinet depth	A
600	249
800	216
1000	216

Rear mounting in 600 mm width Rear mounting in 800 mm width

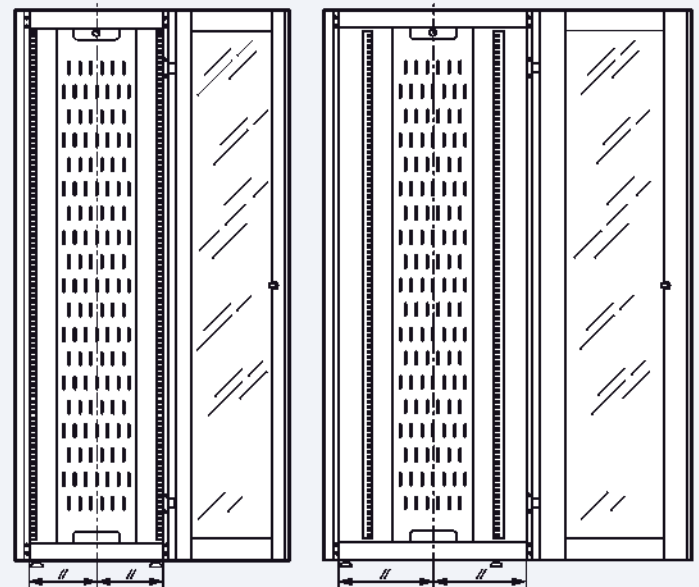

# Linkeo 19" wall-mounting cabinets

## General characteristics

Metal wall-mounting cabinets  
 RAL 7035 textured polyester coating providing excellent resistance to corrosion and scratching  
 Safety glass door  
 Protection index (weatherproof) against solid objects and liquids: IP 20  
 Protection index against mechanical shocks: IK 08  
 Perforations in 19" uprights: 9.5 x 9.5 mm  
 Permissible load: 3 kg/U (or 48 kg for a 16 U, 19" cabinet)

## Compliance with standards

Linkeo cabinets comply with the following standards:

<b>IEC 60529</b> <b>EN 60529</b>	(NF C 20-010) Degrees of protection provided by enclosures (IP code)
<b>IEC 62262</b> <b>EN 62262</b>	(EN 50102, NF C 20-015) Degrees of protection provided by enclosures for electrical equipment against external mechanical impacts (IK code)
<b>IEC 60950-1</b> <b>EN 60950-1</b> <b>C 77-210-1</b>	Safety of data processing equipment
<b>EIA-310-E</b>	Cabinets, racks, panels and associated equipment (ANSI/EIA-310-D-2005)
<b>IEC 60297-3-100</b> <b>DIN 41414-7</b>	(NF C 20-150, NF C 20-151) Dimensions of mechanical structures of the 482.6 mm (19 in) series

Linkeo cabinets can be integrated in installations complying with the following standards:

<b>EN 50173-1</b>	Information technology - Generic cabling systems
<b>EN 50174-1 &amp; 2</b> <b>C 90-480-1 &amp; 2</b>	Information technology - Cabling installation
<b>ISO IEC 11801</b>	Information technology - Generic cabling for customer premises
<b>NF C 15-100</b> <b>Part 4-41</b>	Low voltage electrical installations - Recommendations
<b>UTE C90-483</b>	Residential cabling for communication networks
<b>IEC 60364-4-41</b>	Low voltage electrical installations - Protection for safety - Protection against electric shock

## Dimensions (mm)

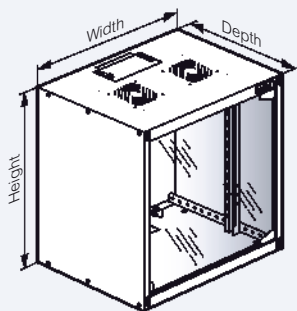

Cat.Nos	Capacity	Height	Width	Depth
<b>0 462 35</b>	6 U	367	600	400
<b>0 462 36</b>	9 U	500		400
<b>0 462 47</b>	12 U	625		400
<b>0 462 48</b>	16 U	810		400

## Door opening (mm)

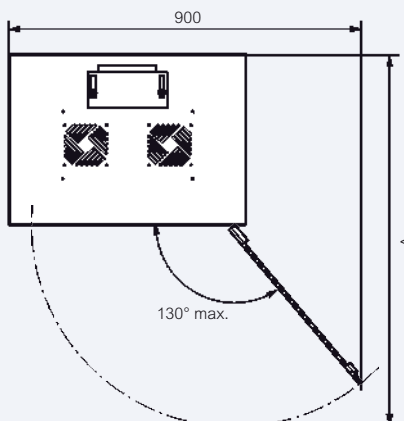

Cat.Nos	Capacity	A
<b>0 462 35</b>	6 U	930
<b>0 462 36</b>	9 U	
<b>0 462 47</b>	12 U	1130
<b>0 462 48</b>	16 U	

## Fixing (mm)

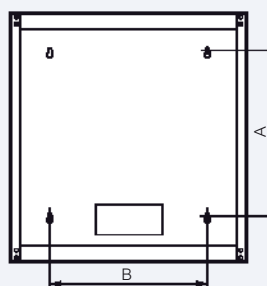

Cat.Nos	Capacity	A	B
<b>0 462 35</b>	6 U	153	400
<b>0 462 36</b>	9 U	286	
<b>0 462 47</b>	12 U	419	
<b>0 462 48</b>	16 U	597	

## Fan kit (mm)

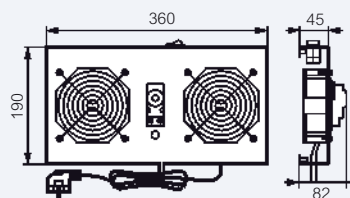

# Bati-rack

# Wall-mounting rack for weatherproof cabinets

## Bati-rack general characteristics

Metal bati-rack. RAL 7035 textured polyester coating providing excellent resistance to corrosion and scratching. Perforations in 19" uprights: 9.5 x 9.5 mm. Permissible load: 300 kg

## Dimensions (mm)

### 2-upright bati-rack Cat.No 0 463 95

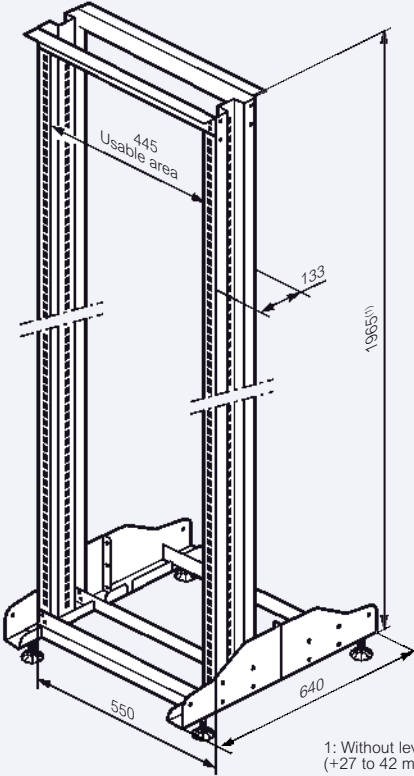

1: Without levelling feet  
(+27 to 42 mm with feet)

### 4-upright bati-rack Cat.No 0 463 96

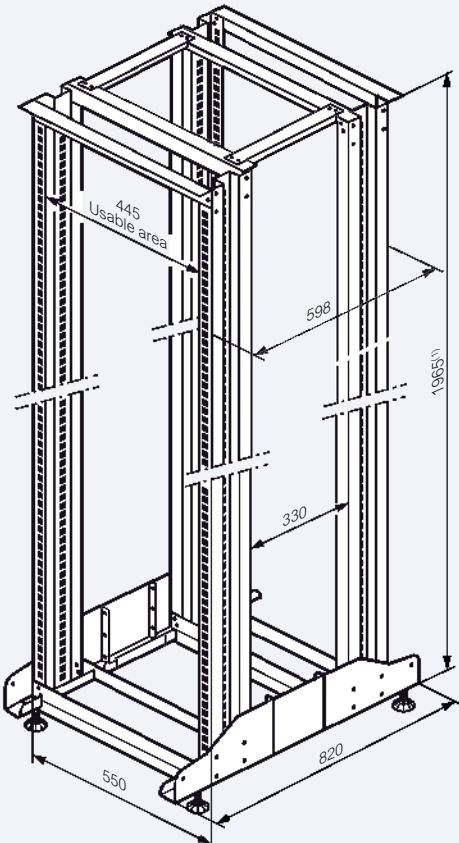

## Rack mounting in weatherproof cabinets

Perforations in uprights: 9.5 x 9.5 mm

Atlantic cabinets					
Rack Cat.Nos	Capacity	Cat.Nos	Dimensions H x W x D (mm)	Usable dim. under door	
				A (mm)	B (mm)
0 462 27	6 U	0 355 06	400 x 600 x 250	145	105
0 462 28	12 U	0 355 08	600 x 400 x 250	145	105
0 462 28	12 U	0 355 10	600 x 600 x 250	145	105
0 462 28	12 U	0 355 20	600 x 600 x 300	145	155
0 462 28	12 U	0 355 36	600 x 600 x 400	145	255
0 462 28	12 U	0 355 21	600 x 800 x 300	145	155
0 462 29	16 U	0 355 14	800 x 600 x 250	145	105
0 462 29	16 U	0 355 23	800 x 600 x 300	145	155
0 462 29	16 U	0 355 28	800 x 600 x 400	145	255
0 462 29	16 U	0 355 15	800 x 800 x 250	145	105
0 462 29	16 U	0 355 24	800 x 800 x 300	145	155
Marina cabinets					
0 462 28	12 U	0 362 55/75	600 x 400 x 250	150	100
0 462 29	16 U	0 362 61/81	800 x 600 x 300	150	150

### Width 400 mm

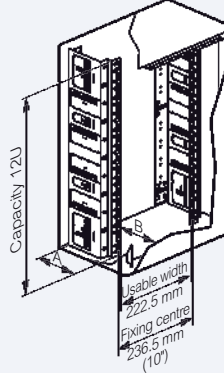

### Width 600 mm

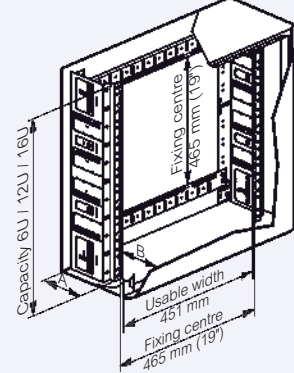

### Width 800 mm

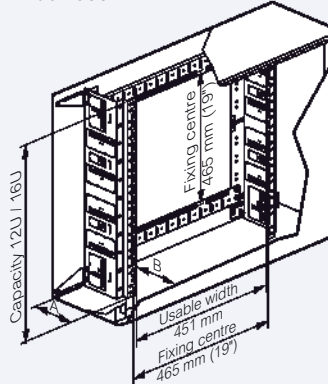

Depth adjusting aid with slides Cat.Nos 0 367 44/45 for Atlantic cabinets depth 300 and 400 mm

## Rack fixing centres (mm)

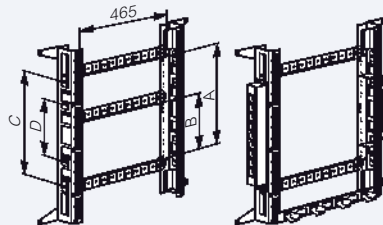

Cat.Nos	Capacity	A	B	C	D
0 462 27	6 U	-	236.5	-	236.5
0 462 28	12 U	465	236.5	465	236.5
0 462 29	16 U	465	236.5	465	236.5

## Wall fixing (mm)

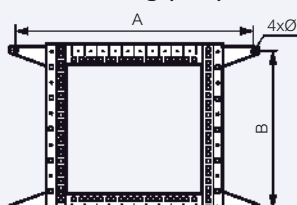

Wall-mounting rack			
Cat.Nos	Capacity	A	B
0 462 27	6 U	725	325
0 462 28	12 U	725	525
0 462 29	16 U	725	725

## DLPlus mini-trunking: profiles and accessories

BODIES	SECTION	FINISHING ACCESSORIES						
		End cap	Internal angle	External angle	Flat angle	Cover joint	Flat T junction	Junction box
Size and shape	Length 2.10 m							
<b>20 x 12.5</b> 	0 300 07 0 300 08	0 312 02	0 302 21	0 302 21	0 302 23	0 336 02	0 302 24	0 303 16 <sup>(1)</sup>
<b>32 x 12.5</b> 	0 300 14 0 300 15	0 312 03	0 302 51	0 302 51	0 302 53	0 336 03	0 302 54	0 303 16
<b>32 x 16</b> 	0 308 04	0 312 07	0 333 25	0 333 25	0 333 27	0 336 04	0 333 30	0 303 16
<b>40 x 20</b> 	0 300 27	0 312 11	0 302 81	0 302 81	0 302 83	0 336 06	0 302 08	0 303 16
<b>60 x 20</b> 	0 301 14	0 302 90	0 302 91	0 302 92	0 302 93	0 336 08	0 302 09	0 303 16
<b>75 x 20</b> 	0 300 33	0 303 00	0 303 01	0 303 02	0 303 03	0 336 09	0 302 18	0 303 16

1: Dimensions: 75 x 75 mm

### Cable-grip

It makes the installation easier and faster by containing all the wires inside the trunking body before the cover is clipped

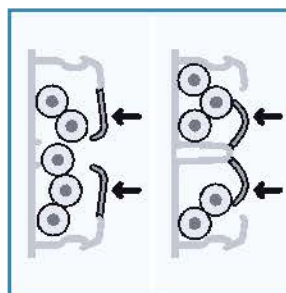

#### Comfortable implementation

- During installation, the conductors stay in place in the 1 or 2 compartment mini-trunking thanks to cable-grip membranes



#### Speed of installation

- Cable holding is integrated with the trunking (no staple to add)
- Easy conductors position
- Quick cover fitting

## DLPlus mini-trunking: wiring accessories frames

BODIES	MOSAIC FRAMES											
	Installation at the end of the mini-trunking <sup>(1)</sup>						Installation alongside the mini-trunking <sup>(1)</sup>					
Size and shape	2 modules <sup>(2)</sup>	3 modules	4 modules <sup>(3)</sup>	6 modules <sup>(4)</sup>	2 x 4 modules <sup>(5)</sup>	3 x 4 modules <sup>(6)</sup>	2 modules <sup>(2)</sup>	3 modules <sup>(3)</sup>	4 modules <sup>(4)</sup>	6 modules <sup>(5)</sup>	2 x 4 modules <sup>(6)</sup>	3 x 4 modules <sup>(7)</sup>
	1 frame + 1 adaptor						1 frame + 1 adaptor					
<b>20 x 12.5</b> 	0 316 11 0 316 40	0 316 40	0 316 13 0 316 40	0 316 14 0 316 40	0 316 21 0 316 40	0 316 22 0 316 40	0 316 11 0 317 01	0 317 01	0 316 13 0 317 02	0 316 14 0 317 03	0 316 21 0 317 02	0 316 22 0 317 03
<b>32 x 12.5</b> 	0 316 11 0 316 41	0 316 41	0 316 13 0 316 41	0 316 14 0 316 41	0 316 21 0 316 41	0 316 22 0 316 41	0 316 11 0 317 01	0 317 01	0 316 13 0 317 02	0 316 14 0 317 03	0 316 21 0 317 02	0 316 22 0 317 03
<b>32 x 16</b> 	0 316 11 0 316 41	0 316 41	0 316 13 0 316 41	0 316 14 0 316 41	0 316 21 0 316 41	0 316 22 0 316 41	0 316 11 0 317 04	0 317 04	0 316 13 0 317 05	0 316 14 0 317 06	0 316 21 0 317 05	0 316 22 0 317 06
<b>40 x 20</b> 	0 316 11 0 316 47	0 316 47	0 316 13 0 316 47	0 316 14 0 316 47	0 316 21 0 316 47	0 316 22 0 316 47	0 316 11 0 317 07	0 317 07	0 316 13 0 317 08	0 316 14 0 317 09	0 316 21 0 317 08	0 316 22 0 317 09
<b>60 x 20</b> 	0 316 11 0 316 45	0 316 45	0 316 13 0 316 45	0 316 14 0 316 45	0 316 21 0 316 45	0 316 22 0 316 45	0 316 11 0 317 07	0 317 07	0 316 13 0 317 08	0 316 14 0 317 09	0 316 21 0 317 08	0 316 22 0 317 09
<b>75 x 20</b> 	-	-	0 316 13 0 316 48	0 316 14 0 316 48	0 316 21 0 316 48	0 316 22 0 316 48	0 316 11 0 317 07	0 317 07	0 316 13 0 317 08	0 316 14 0 317 09	0 316 21 0 317 08	0 316 22 0 317 09

1: Use with Mosaic socket outlets  
2: Frame dimensions: 127 x 74 x 60 mm  
3: Frame dimensions: 149 x 74 x 60 mm

4: Frame dimensions: 172 x 74 x 60 mm  
5: Frame dimensions: 217 x 74 x 60 mm

6: Frame dimensions: 162 x 167 x 60 mm  
7: Frame dimensions: 228 x 167 x 60 mm

BODIES	Special surface mounting frames for wiring accessories (p. 732-734)		Surface mounting frames for 60 mm fixing centres wiring accessories (p. 735)		
	Installation alongside the mini-trunking		Installation alongside the mini-trunking		
Size and shape					
	1 gang for horizontal or vertical	2 gang for horizontal or vertical	1 gang for horizontal or vertical	2 gang for horizontal or vertical	3 gang for horizontal or vertical
<b>20 x 12.5</b> 	0 314 04	0 314 14	0 316 94	0 316 95	0 316 96
<b>32 x 12.5</b> 	0 314 04	0 314 14	0 316 94	0 316 95	0 316 96
<b>32 x 16</b> 	0 314 56	0 314 66	0 316 94	0 316 95	0 316 96
<b>40 x 20</b> 	0 314 08	0 314 18	0 316 94	0 316 95	0 316 96
<b>60 x 20</b> 	0 314 08	0 314 18	0 316 94	0 316 95	0 316 96
<b>75 x 20</b> 	0 314 08	0 314 18	0 316 94	0 316 95	0 316 96

# DLPlus mini-trunking 20 x 12.5 and 32 x 12.5

profiles and finishing accessories

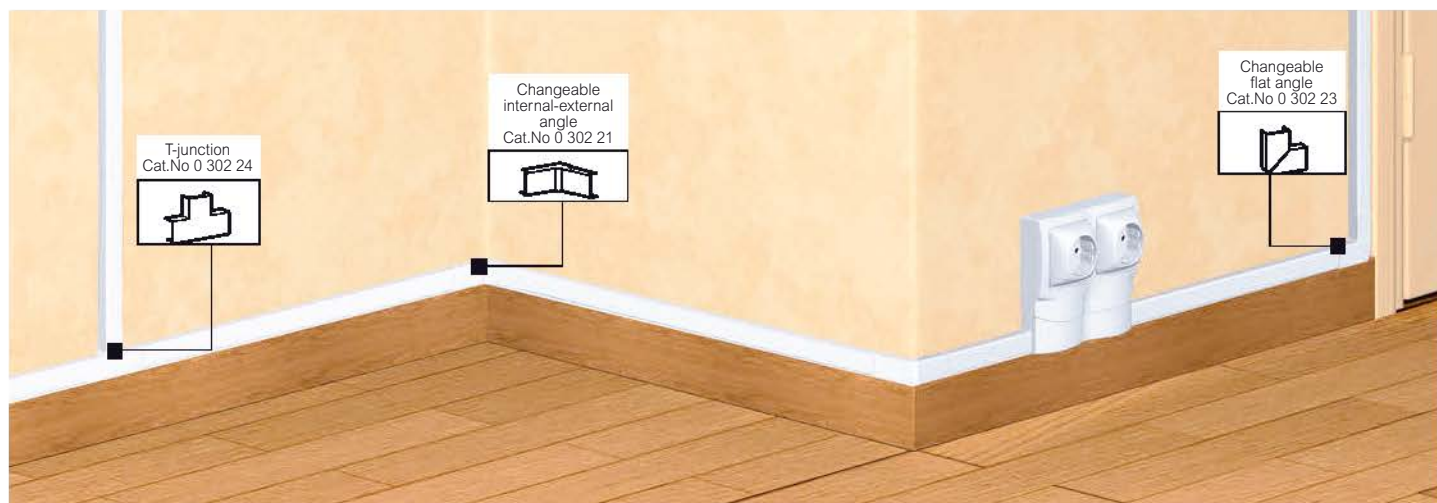

Selection chart **p. 730-731**  
 Wiring capacity chart **see e-catalogue**

Pack	Cat.Nos		Mini-trunking
	20 x 12.5	32 x 12.5	EN 50085-2-1 approved
			<b>Without central partition</b>
			Mini-trunking with cable grip
			Equipped with an integrated device for holding cables in place
120'   180'	0 300 08	0 300 15	Length 2.10 m
			<b>With central partition</b>
120'   180'	0 300 07	0 300 14	Length 2.10 m
Pack	Cat.Nos		Special frames
			Supplied with end cap and divider for separation of currents
			<b>Installation alongside the mini-trunking</b>
			For vertical or horizontal mounting of surface mounting wiring accessories (p. 738)
10	0 314 04		1 gang
5	0 314 14		2 gang
Pack	Cat.Nos		Finishing accessories
20	0 312 02	0 312 03	End cap
10	0 302 21	0 302 51	Changeable internal-external angle
10	0 302 23	0 302 53	Changeable flat angle
20	0 336 02	0 336 03	Cover joint
10	0 302 24	0 302 54	Flat T-junction
1: Number of metres in pack			
Pack	Cat.Nos		Adaptors
			<b>Adaptor for mounting Mosaic frames at end of the mini-trunking</b>
			For 20 x 12.5 mini-trunking
10	0 316 40		
			For 32 x 12.5 mini-trunking
10	0 316 41		
			<b>Adaptor for mounting Mosaic frames alongside the mini-trunking</b>
			For Mosaic frames Cat.Nos 0 316 11
10	0 317 01		
			For Mosaic frames Cat.Nos 0 316 13 and 0 316 21
10	0 317 02		
			For Mosaic frames Cat.Nos 0 316 14 and 0 316 22
5	0 317 03		

Connection of luminaires **p. 735**

Other frames for wiring accessories **p. 735**

Surface-mounting wiring accessories **p. 738**

# DLPlus mini-trunking 32 x 16 and 40 x 20

## profiles and finishing accessories

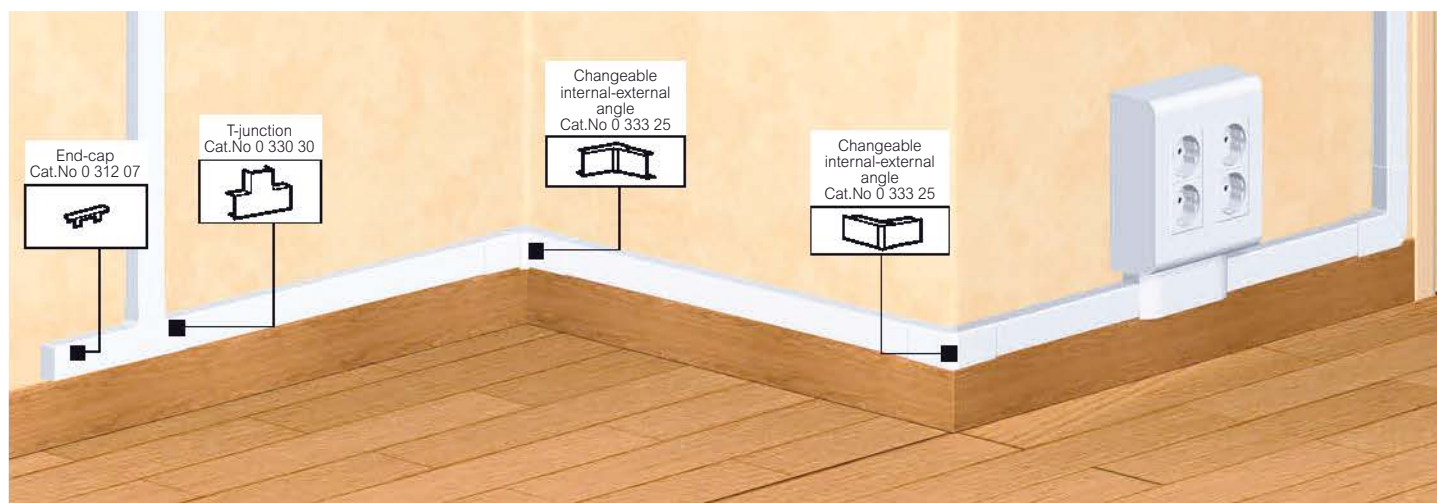

Selection chart **p. 730-731**  
Wiring capacity chart **see e-catalogue**

Pack	Cat.Nos		<b>Mini-trunking with cable grip</b>
60'   48'	32 x 16 0 308 04	40 x 20 0 300 27	EN 50085-2-1 approved Equipped with an integrated device for holding cables in place <b>Without central partition</b> Length 2.10 m

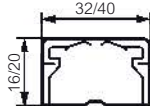

Pack	Cat.Nos		<b>Finishing accessories</b>
10	32 x 16 0 312 07	40 x 20 0 312 11	End cap
10	0 333 25	0 302 81	Changeable internal-external angle
10	0 333 27	0 302 83	Changeable flat angle
20	0 336 04	0 336 06	Cover joint
10	0 333 30	0 302 08	Flat T-junction

Pack	Cat.Nos		<b>Special frames</b>
10	32 x 16 0 314 56	40 x 20 0 314 08	Supplied with end cap and divider for separation of currents <b>Installation alongside the mini-trunking</b> For vertical or horizontal mounting of surface mounting wiring accessories (p. 738)
5	0 314 66	0 314 18	1 gang 2 gang

1: Number of metres in pack

Pack	Cat.Nos		<b>Adaptors</b>
10	32 x 16 0 316 41	40 x 20 0 316 47	<b>Adaptors for mounting Mosaic frames at end of the mini-trunking</b> For 32 x 16 and 40 x 20 mini-trunking
10	32 x 16 0 317 04	40 x 20 0 317 07	<b>Adaptors for mounting Mosaic frames alongside the mini-trunking</b> For Mosaic frames Cat.Nos 0 316 11
5	0 317 05	0 317 08	For Mosaic frames Cat.Nos 0 316 13 and 0 316 21
5	0 317 06	0 317 09	For Mosaic frames Cat.Nos 0 316 14 and 0 316 22

Connection of luminaires **p. 735**

Junction boxes **p. 735**

Other frames for wiring accessories **p. 735**

Surface-mounting wiring accessories **p. 738**

# DLPlus mini-trunking 60 x 20 and 75 x 20

profiles and finishing accessories



Selection chart **p. 730-731**  
Wiring capacity chart **see e-catalogue**

Pack	Cat.Nos	3-compartment mini-trunking
32'   20'	60 x 20 0 301 14   75 x 20 0 300 33	3 compartments for distribution of high and low currents Length 2.10 m White 

Pack	Cat.Nos	Finishing accessories
10	60 x 20 0 302 90   75 x 20 0 303 00	End cap
10	0 302 91   0 303 01	Changeable internal angle
10	0 302 92   0 303 02	Changeable external angle
10	0 302 93   0 303 03	Flat angle
20	0 336 08   0 336 09	Cover joint
10	0 302 09   0 302 18	Flat T-junction
1	0 328 05	Junction to floor duct

Pack	Cat.Nos	Special frames
Supplied with end cap and divider for separation of currents		
<b>Installation alongside the mini-trunking</b> For vertical or horizontal mounting of surface mounting wiring accessories (p. 738)		
10	0 314 08	1 gang
5	0 314 18	2 gang

1: Number of metres in pack

Pack	Cat.Nos	Adaptors
<b>Adaptors for mounting Mosaic frames at the end of the mini-trunking</b>		
10	0 316 45	For 60 x 20 mini-trunking
10	0 316 48	For 75 x 20 mini-trunking (for 4 and 6 modules only)
<b>Adaptors for mounting Mosaic frames alongside the mini-trunking</b>		
10	0 317 07	For Mosaic frames Cat.Nos 0 316 11
5	0 317 08	For Mosaic frames Cat.Nos 0 316 13 and 0 316 21
5	0 317 09	For Mosaic frames Cat.Nos 0 316 14 and 0 316 22

Other frames for wiring accessories  
(see opposite)

Surface-mounting wiring accessories **p. 738**



# DLPlus mini-trunking

## frames and installation accessories



Pack	Cat.Nos	Mosaic frames
10	0 316 11	Supplied with support, plate and divider for separation of currents Vertical or horizontal mounting To be used with 2 module Mosaic sockets 2 modules
5	0 316 13	4 modules (for horizontal mounting only)
5	0 316 14	6 modules (for horizontal mounting only)
10	0 316 21	2 x 4 modules
10	0 316 22	3 x 4 modules

Pack	Cat.Nos	Junction boxes
10	0 303 16	White 75 x 75 x 35 mm
10	0 303 26	110 x 110 x 50 mm
10	0 303 36	150 x 150 x 65 mm

Pack	Cat.Nos	60 mm fixing centres wiring accessories frames
5	0 316 94	Installation alongside the mini-trunking Supplied with divider for separation of currents 1 gang, for vertical or horizontal mounting
5	0 316 95	2 gang, for horizontal mounting
5	0 316 96	3 gang, for horizontal mounting

Pack	Cat.Nos	Connection of luminaires
10	0 306 54	Plug-in ceiling rose unit supplied complete with connector hook and locking nut Maximum suspended weight: 25 kg as long as unit is equipped with a suitable fixing device
135	0 306 67	Linking piece between the above unit and the ring trunking Length 3 m
10	0 302 16	Wall and ceiling tap-off for 40 x 20 mini-trunking
10	0 302 26	Wall and ceiling tap-off for 60/75 x 20 mini-trunking
10	0 333 17	Wall and ceiling tap-off for 32 x 12.5 mini-trunking
10	0 333 29	Wall and ceiling tap-off for 32 x 16 mini-trunking

Pack	Cat.Nos	Cutting accessory for trunking
1	0 306 98	DLPlus cutting unit For cutting all plastic trunking Avoids vibration when cutting bases and covers Aluminium Dim.: 225 x 142 x 76 mm

Pack	Cat.Nos	Insulation accessory
10	0 304 18	Base joint Adjustable wall insulation joint, supplied in 5 m lengths Provides continuity between the trunking and the wall, in particular in internal angles

Pack	Cat.Nos	Fixing accessories for trunkings
100	0 308 98	For fixing all plastic trunkings
100	0 308 99	<b>Wall plugs for immediate fixing</b> No screws or nails required For mini-trunking
12	0 309 49	<b>Cartridge of Neoprene</b> Adhesive for glue gun
200	0 308 97	<b>DLP rapid wall plug</b> For 10 mm min. plasterboard walls at least 20 mm away from the concrete surface For fixing DLP plastic trunking in a single operation Used with a special tool for drill (Ø8 mm), supplied in each pack of 200 wall plugs Tensile resistance: 25 kg

## LED system mini-trunking 40 x 12.5 profiles and finishing accessories

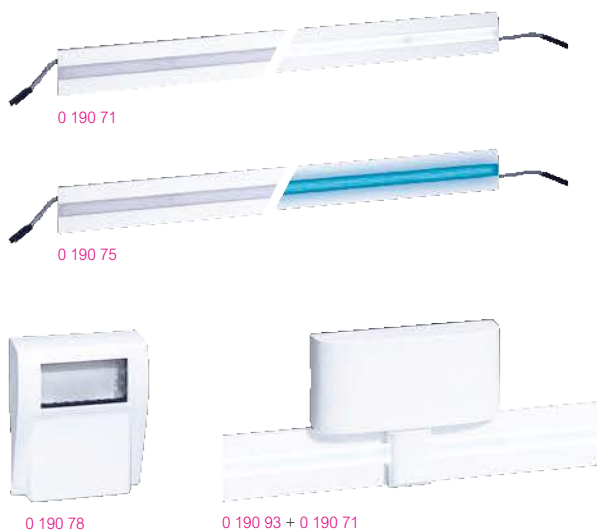

## LED system plinth 82 x 12.5 profiles and finishing accessories

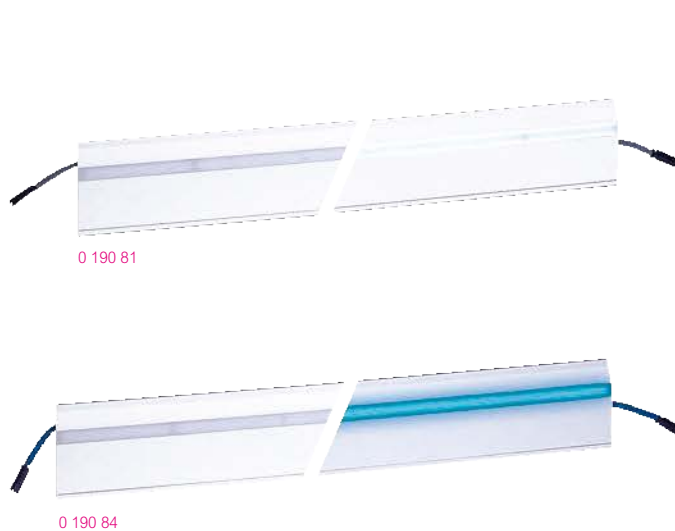

Pack	Cat.Nos	Mini-trunking
		Mini-trunking modules equipped with LED lights covers for contemporary mood lighting To be equipped with drivers Cat.No 0 190 90/91/92 (see opposite) according to required power Can take Mosaic or Arteor wiring accessories via support frame Cat.No 0 190 78
		<b>White colour LED modules</b>
2	0 190 70	Length 0.5 m
2	0 190 71	Length 1 m
2	0 190 72	Length 2 m
1	0 190 73	Door frame kit
		<b>Blue colour LED modules</b>
2	0 190 74	Length 0.5 m
2	0 190 75	Length 1 m
2	0 190 76	Length 2 m
1	0 190 77	Door frame kit
		<b>Mini-trunking without LED</b>
72 <sup>1</sup>	0 190 03	Length 2.1 m Supplied with cover With separation partition
		<b>Finishing accessories</b>
10	0 190 36	End cap
10	0 190 16	Changeable internal angle
10	0 190 12	Changeable external angle
10	0 190 24	Flat angle B
10	0 190 20	Flat angle A
10	0 190 40	Cover joint
		<b>Mosaic / Arteor support frame</b>
1	0 190 78	For LED system mini-trunking and plinth 4 modules (for horizontal mounting only) To be used with 2-module Mosaic or Arteor sockets



Pack	Cat.Nos	Plinth
		Plinth modules equipped with LED lights covers for contemporary mood lighting To be equipped with drivers Cat.No 0 190 90/91/92 (see opposite) according to required power Can take Mosaic or Arteor wiring accessories via support frame Cat.No 0 190 78
		<b>White colour LED modules</b>
1	0 190 80	Length 0.5 m
1	0 190 81	Length 1 m
1	0 190 82	Length 2 m
		<b>Blue colour LED modules</b>
1	0 190 83	Length 0.5 m
1	0 190 84	Length 1 m
1	0 190 85	Length 2 m
		<b>Plinth without LED</b>
30 <sup>1</sup>	0 190 06	Length 2.1 m Supplied with cover With separation partition
		<b>Finishing accessories</b>
10	0 190 49	End cap
5	0 190 45	Changeable internal angle
5	0 190 43	Changeable external angle
10	0 190 53	Right-hand flat junction
10	0 190 54	Left-hand flat junction
10	0 190 51	Cover joint
5	0 190 47	Junction to 30 x 12.5 mm and 40 x 12.5 mm mini-trunking
		<b>Fixing accessories for drivers</b>
		For fixing drivers alongside LED system mini-trunkings and plinths
		<b>Surface mounting</b>
		Supplied with two adaptors (for 40 x 12.5 mm respectively 80 x 12.5 mm profiles)
1	0 190 93	For 10 W driver Cat.No 0 190 90
1	0 190 94	For 35 and 60 W drivers Cat.No 0 190 91/92
5	0 190 96	<b>Flush-mounting</b> For 35 and 60 W drivers Cat.No 0 190 91/92

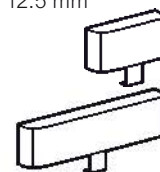
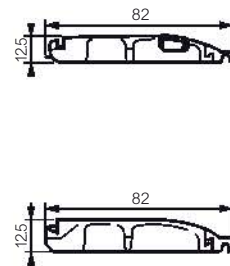

## LED system covers for snap-on DLP trunking and columns



0 190 99 + 6 038 05 (p. 767)

0 190 87 + 0 756 03 (p. 748)

## LED system flush-mounting lighting modules



6 607 80

6 607 81

6 607 85

Pack	Cat.Nos	LED system covers for snap-on DLP trunking and columns
		45 mm width covers with LED lights, to be installed on snap-on DLP trunking (p. 745 to 751) and columns (p. 767) instead of the standard cover supplied with the body To be equipped with drivers Cat.No 0 190 90/91/92 according to required power
		<b>White colour LED modules</b>
1	0 190 86	Length 0.5 m
1	0 190 87	Length 1 m
1	0 190 88	Length 2 m
		<b>Red / green colour LED module</b>
1	0 190 99	Length 0.5 m
		<b>Cover joint</b>
10	6 380 00	Width 45 mm
		<b>Drivers for LED system mini-trunkings, plinths &amp; covers</b>
1	0 190 90	10 W - for a maximum length of 2 m
1	0 190 91	35 W - for a maximum length of 6 m
1	0 190 92	60 W - for a maximum length of 10 m
		<b>Links</b>
1	0 190 97	Length 0.3 m
1	0 190 98	Length 3 m



Pack	Cat.Nos	Flush-mounting LED lighting modules
		IP 44 - IK 07 (IP 40 for the automatic switch version) Aluminium-polycarbonate
		<b>1.2 W - 40 lm - for way guidance</b>
		Total consumption: 1.4 W Color temperature: 3000 K 262 x 87 mm
1	6 607 80	White finish
1	6 607 81	Aluminium finish
1	6 607 82	Black finish
		<b>4 W - 300 lm</b>
		Total consumption: - standard version: 4.2 W - automatic switch version: 4.4 W Color temperature: 4000 K 355 x 87 mm
1	6 607 83	White finish
1	6 607 84	Aluminium finish
1	6 607 85	Black finish
1	6 607 86	White finish with automatic switch (IR detection)
1	6 607 87	Aluminium finish with automatic switch (IR detection)
		<b>7 W - 600 lm</b>
		Total consumption: - standard version: 7.2 W - automatic switch version: 7.4 W Color temperature: 4000 K 355 x 87 mm
1	6 607 88	White finish
1	6 607 89	Aluminium finish
1	6 607 90	Black finish
1	6 607 91	White finish with automatic switch (IR detection)
1	6 607 92	Aluminium finish with automatic switch (IR detection)

## Surface-mounting wiring accessories



Pack	Cat.Nos	Switches
10	0 860 01	Two-way switch 10 AX - 250 V~
10	0 860 06	Push-button - NO - 6 A - 250 V~
<b>Socket outlets</b>		
10	0 860 31	2P+E socket outlet German standard 16 A - 250 V~ shuttered for child safety
10	0 860 29	2P+E socket outlet German standard 16 A - 250 V~
<b>TV socket</b>		
10	0 860 40	TV single socket - 0 - 2400 MHz

## Cable guide with adhesive

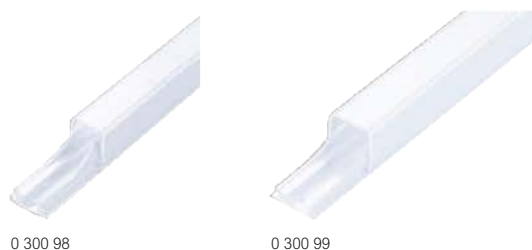

















Pack	Cat.Nos	Cable guide with adhesive
132 <sup>1</sup>	0 300 98	For cable Ø3 to 6 mm
90 <sup>1</sup>	0 300 99	For cable Ø7 and 9 mm

1: Number of metres in pack

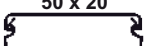

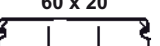
## Distribution mini-trunking: profiles and accessories

BODIES	SECTION		FINISHING ACCESSORIES					
	Length 2 m		End cap	Internal angle	External angle	Flat angle	Cover joint	Flat T-junction
Size and shape	Wall plugs	With adhesive						
15 x 10 	6 381 00	6 381 09	6 381 05	6 381 01	6 381 02	6 381 03	6 381 06	6 381 04
20 x 12 	6 381 20	6 381 29	6 381 25	6 381 21	6 381 22	6 381 23	6 381 26	6 381 24
24 x 14 	6 381 30	6 381 39	6 381 35	6 381 31	6 381 32	6 381 33	6 381 36	6 381 34
16 x 16 	6 381 10	6 381 19	6 381 15	6 381 11	6 381 12	6 381 13	6 381 16	6 381 14
32 x 16 	6 381 40	6 381 49	6 381 45	6 381 41	6 381 42	6 381 43	6 381 46	6 381 44
40 x 16 	6 381 50	6 381 59	6 381 55	6 381 51	6 381 52	6 381 53	6 381 56	6 381 54
50 x 20  	6 381 60	-	6 381 65	6 381 61	6 381 62	6 381 63	6 381 66	6 381 64
	6 381 68	-						
60 x 20 	6 381 70	-	6 381 75	6 381 71	6 381 72	6 381 73	6 381 76	6 381 74
40 x 40 	6 381 80	-	6 381 85	6 381 81	6 381 82	6 381 83	6 381 86	6 381 84

# Distribution mini-trunking 15 x 10 / 20 x 12 / 24 x 14 and 16 x 16

## Distribution 15 x 10 mm

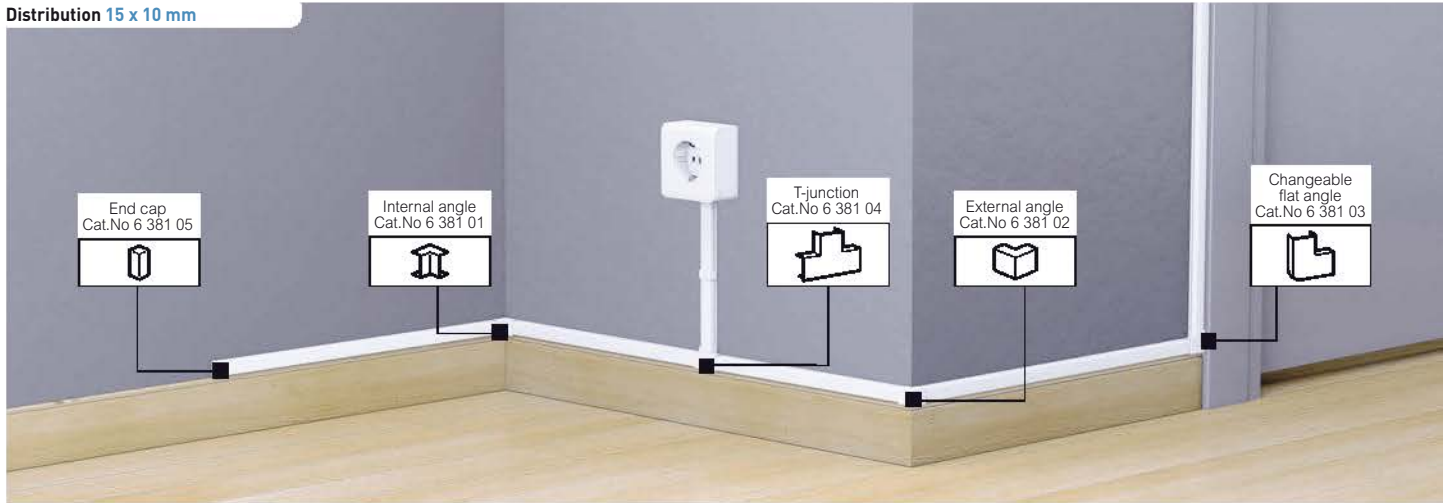

Selection chart **p. 739**  
 Technical characteristics **see e-catalogue**

Pack	Cat.Nos	15 x 10 mm mini-trunking
154 <sup>1</sup>	6 381 00	Without central partition Conform to EN 50085-2-1 To be fixed with wall plugs Supplied in 77 lengths of 2 metres
80 <sup>1</sup>	6 381 09	With adhesive Supplied in 40 lengths of 2 metres

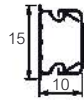

Pack	Cat.Nos	24 x 14 mm mini-trunking
70 <sup>1</sup>	6 381 30	Without central partition Conform to EN 50085-2-1 To be fixed with wall plugs Supplied in 35 lengths of 2 metres
66 <sup>1</sup>	6 381 39	With adhesive Supplied in 33 lengths of 2 metres

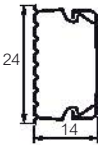

Finishing accessories for 15 x 10 mm mini-trunking		
10	6 381 05	End cap
10	6 381 01	Internal angle
10	6 381 02	External angle
10	6 381 03	Flat angle
10	6 381 06	Cover joint
10	6 381 04	Flat T-junction

Finishing accessories for 24 x 14 mm mini-trunking		
10	6 381 35	End cap
10	6 381 31	Internal angle
10	6 381 32	External angle
5	6 381 33	Flat angle
10	6 381 36	Cover joint
5	6 381 34	Flat T-junction

20 x 12 mm mini-trunking		
96 <sup>1</sup>	6 381 20	Without central partition Conform to EN 50085-2-1 To be fixed with wall plugs Supplied in 48 lengths of 2 metres
42 <sup>1</sup>	6 381 29	With adhesive Supplied in 21 lengths of 2 metres

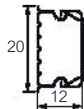

16 x 16 mm mini-trunking		
150 <sup>1</sup>	6 381 10	Without central partition Conform to EN 50085-2-1 To be fixed with wall plugs Supplied in 75 lengths of 2 metres
50 <sup>1</sup>	6 381 19	With adhesive Supplied in 23 lengths of 2 metres

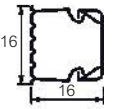

Finishing accessories for 20 x 12 mm mini-trunking		
10	6 381 25	End cap
10	6 381 21	Internal angle
10	6 381 22	External angle
10	6 381 23	Flat angle
10	6 381 26	Cover joint
10	6 381 24	Flat T-junction

Finishing accessories for 16 x 16 mm mini-trunking		
10	6 381 15	End cap
10	6 381 11	Internal angle
10	6 381 12	External angle
10	6 381 13	Flat angle
10	6 381 16	Cover joint
10	6 381 14	Flat T-junction



1: Number of meters in pack

# Distribution mini-trunking 32 x 16 / 40 x 16 / 50 x 20 / 60 x 20 and 40 x 40

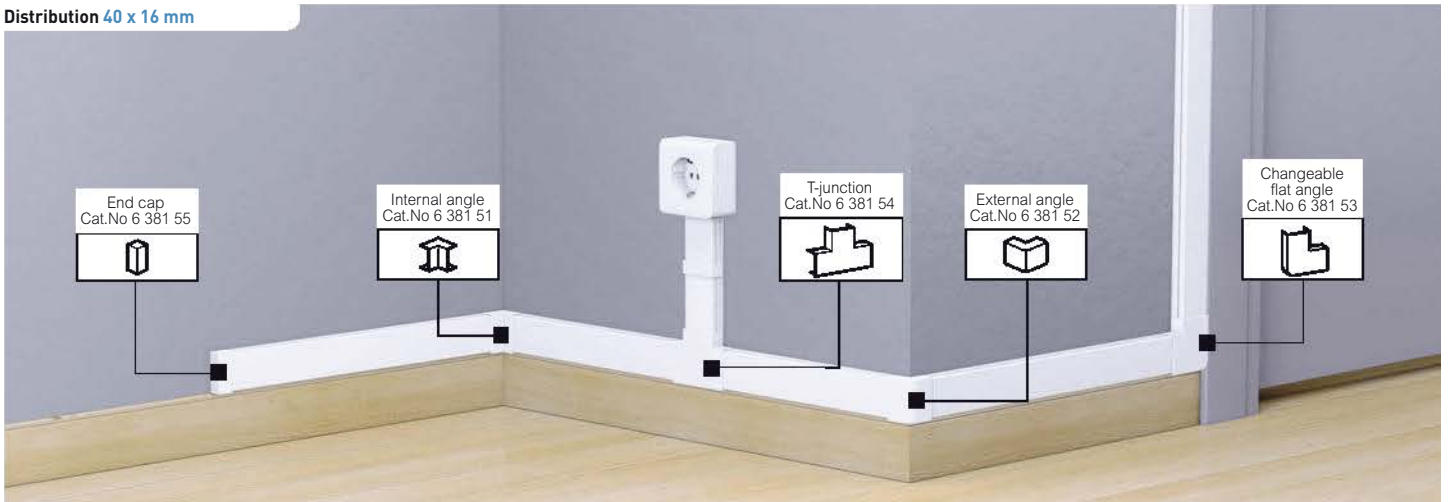
## Distribution 40 x 16 mm

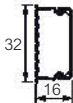
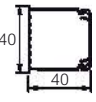

Selection chart **p. 739**  
 Technical characteristics **see e-catalogue**

Pack	Cat.Nos	32 x 16 and 40 x 16 mm mini-trunking	Pack	Cat.Nos	Finishing accessories for 50 x 20 and 60 x 20 mm mini-trunking		
80'	32 x 16 6 381 40	Without central partition Conform to EN 50085-2-1 To be fixed with wall plugs Supplied in 40 lengths of 2 metres With adhesive Supplied in 18 lengths of 2 metres 	5   5	50 x 20 6 381 65	60 x 20 6 381 75	End cap	
36'	6 381 49		5   5	6 381 61	6 381 71	Internal angle	
60'	40 x 16 6 381 50		5   5	6 381 62	6 381 72	External angle	
60'	6 381 59		5   5	6 381 63	6 381 73	Flat angle	
		<b>Finishing accessories for 32 x 16 and 40 x 16 mm mini-trunking</b> End cap Internal angle External angle Flat angle Cover joint Flat T-junction	5   5	6 381 66	6 381 76	Cover joint	
10	32 x 16 6 381 45		40 x 16 6 381 55	5   5	6 381 64	6 381 74	Flat T-junction
10	6 381 41		6 381 51	24	6 381 80	<b>40 x 40 mm mini-trunking</b> Length 2 m Supplied in 12 lengths of 2 metres Conform to EN 50085-2-1 Without central partition 	
5   10	6 381 42		6 381 52			<b>Finishing accessories for 40 x 40 mm mini-trunking</b> End cap Internal angle External angle Flat angle Cover joint Flat T-junction	
10	6 381 43		6 381 53	10	6 381 85		
10	6 381 46		6 381 56	5	6 381 81		
10	6 381 44		6 381 54	5	6 381 82		
		<b>50 x 20 and 60 x 20 mm mini-trunking</b> Conform to EN 50085-2-1 <b>Without central partition</b> Length 2 m Supplied in 20 or 16 length of 2 metres  <b>With central partition</b> Length 2 m Supplied in 20 lengths of 2 metres 	5	6 381 83			
40'   32'	50 x 20 6 381 60		60 x 20 6 381 70	10	6 381 86		
40'	6 381 68			5	6 381 84		

1: Number of meters in pack



# Choose your colour

Three colours of snap-on trunking for a perfect integration in any environment

### Main benefits

- 1 catalogue number = trunking + body + dividers
- Perfect separation of high and low currents and large capacity in each compartment
- Ingenious accessories for simple, intuitive installation



■ Black edition snap-on trunking, p. 745



■ White snap-on trunking, p. 747



■ Grey snap-on trunking, p. 750

## MORE INFORMATION



[www.export.legrand.com](http://www.export.legrand.com)



E-catalogue

TRUNKING			TRUNKING		
Number of compartments	Cover width	Cross-section (mm)	Monobloc: body + cover <sup>(1)</sup>	Divider	Fishplate body joint
<b>SNAP-ON TRUNKING - 45 mm cover</b>					
	45	50 x 80	● 0 757 50	0 756 09	-
			○ 0 756 01	0 756 09	0 756 61
			● 0 758 00	0 756 09	0 758 30
	45	50 x 105	0 756 02	0 756 09	0 756 62
	45 45	50 x 130	● 0 757 52	-	-
			○ 0 756 03	-	0 756 61
			● 0 758 02	-	0 758 30
	45 45	50 x 145	0 756 04	-	0 756 63
	45 45 45	50 x 180	○ 0 756 06	-	0 756 61
			● 0 758 04	-	0 758 30

1: Partition(s) integral to the body

2: Internal and external corner angles supplied with multi-compartment partition joint

## Mechanisms for snap-on DLP trunking

### Mounting functions

The Soluclip accessory is very easy to install with any Mosaic or Arteor function and offers the following features:

- Anti-slip
- Anti-pullout
- IP 4X
- Perfect cover finish



- 0 756 90
- 0 757 86
- 0 758 36

### Sockets for snap-on trunking

Sockets for snap-on trunking have been specially designed to meet the requirements for installation and use in total compliance with the new standard EN 50085-2-1. The sockets are fitted with the Soluclip accessory which has the following features:

- Anti-slip
- Anti-pullout
- IP 4X
- Perfect finish

		Standard	Tamperproof	Red	Black
2 x 2P+E		0 772 02	0 772 22	0 772 42	0 772 32
3 x 2P+E		0 772 03	0 772 23	0 772 43	0 772 33
Tap-off accessory			0 771 06		-
2 x RJ 45 Cat. 6 - FTP			0 765 46		0 794 85
2 x RJ 45 Cat. 5e - FTP			0 765 42		-
1 x RJ 45 Cat. 6 - UTP		-	-	-	0 794 81
2 x RJ 45 Cat. 6 - STP		-	-	-	0 794 86



AND ACCESSORIES			ANGLES			JUNCTIONS				ACCESSORIES	
Stick-on body joint	Cover joint	End cap	Internal angles <sup>(2)</sup>	External angles	Flat angles	Flat junctions with width 80 mm	Flat junctions with width 105 mm	Angled junctions 85/105/130 mm	Junction with floor duct 50 x 12/92 x 20	Extra cover	Adaptor for modular wiring accessories
0 757 80	0 757 85	0 757 55	0 757 60	0 757 65	0 757 70	0 757 75	-	-	-	0 757 79	-
0 756 66	0 756 69	0 756 11	0 756 21	0 756 31	0 756 41	0 756 71	-	0 756 81 + 0 756 21	0 756 88	0 756 08	0 310 69
0 758 33	0 758 35	0 758 05	0 758 10	0 758 15	0 758 20	0 758 25	-	-	-	0 758 29	-
0 756 67	0 756 69	0 756 12	0 756 22	0 756 32	0 756 42	0 756 72	0 756 76	0 756 81 + 0 756 22	0 756 88	0 756 08	0 310 69
0 757 80	2 x 0 757 85	0 757 57	0 757 62	0 757 67	0 757 72	0 757 75	-	-	-	0 757 79	-
0 756 66	2 x 0 756 69	0 756 13	0 756 23	0 756 33	0 756 43	0 756 71	0 756 75	0 756 81 + 0 756 23	0 756 88	0 756 08	0 310 69
0 758 33	0 758 35	0 758 07	0 758 12	0 758 17	0 758 22	0 758 25	-	-	-	0 758 29	-
① 0 756 66 + ② 0 756 67	2 x 0 756 69	0 756 14	0 756 24	0 756 34	0 756 44	① 0 756 71 + ② 0 756 72	① 0 756 75 + ② 0 756 76	0 756 81 + 0 756 24	0 756 88	0 756 08	0 310 69
0 756 66	3 x 0 756 69	0 756 16	0 756 26	0 756 36	0 756 36	0 756 71	0 756 75	0 756 81 + 0 756 26	0 756 88	0 756 08	0 310 69
0 758 33	0 758 35	0 758 09	0 758 14	0 758 19	0 758 24	0 758 25	-	-	-	0 758 29	-

### Installation principle for sockets for snap-on trunking

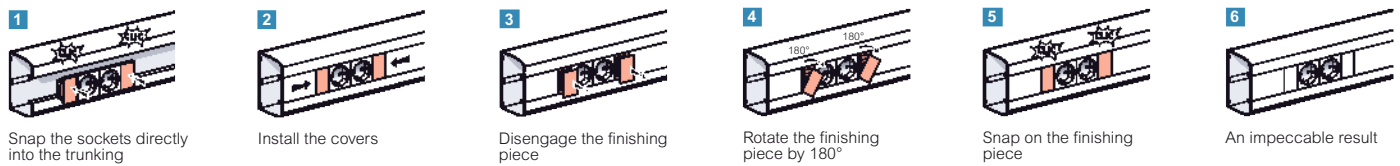

### Installation principle for Mosaic or Arteor functions

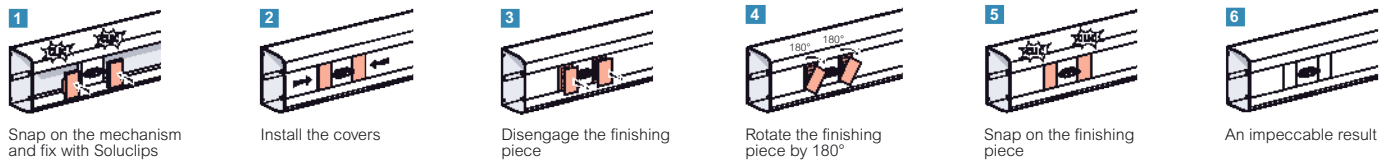

### Operating principle for the tap-off accessory

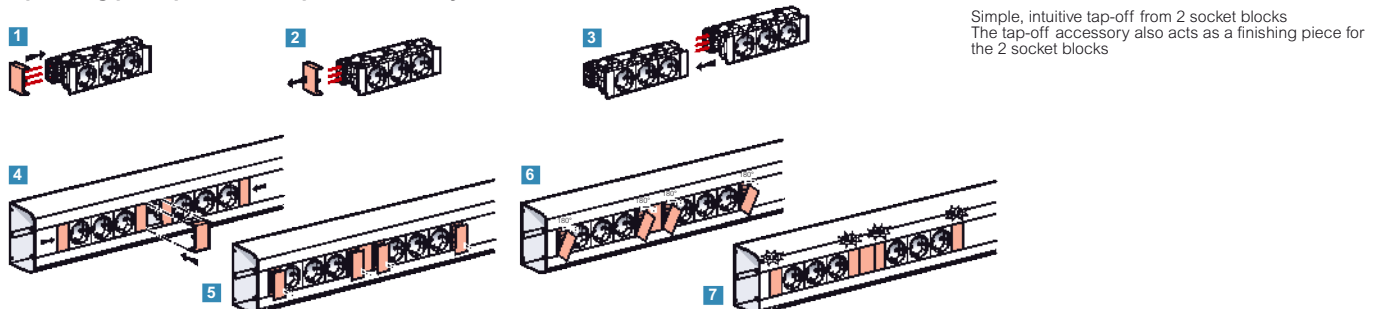



# DLP black edition

Modern design and time saving thanks to the snap-on trunking system

### Main benefits

- Black colour for a modern style
- Quick and easy installation thanks to flexible cover and finishing accessories
- Can be equipped with power and data sockets for snap-on trunking



- Black edition snap-on trunking, p. 745



- 2 sizes supplied complete: body + cover + dividers



- Sockets with Soluclip guaranteed anti-pullout

## LEARN MORE



[www.export.legrand.com](http://www.export.legrand.com)



Workstation solutions guide



0 772 32



0 772 33

Pack	Cat.Nos	Sockets for snap-on trunking
10	0 772 32	Sockets with connection at both sides for snap-on mounting on trunking with 45 mm cover Particularly suitable for installation on snap-on trunking (see opposite) The socket incorporates the Soluclip accessory to hold the socket in place and comply with the standard Connected with automatic terminals <b>German standard</b> 2 x 2 P+E
10	0 772 33	3 x 2 P+E
10	0 794 81	<b>Cat.6 UTP</b> 1 module
10	0 794 85	<b>Cat.6 FTP</b> 2 modules
10	0 794 86	<b>Cat.6 STP</b> 2 modules
10	0 757 86	<b>Soluclip accessory</b> For installation with any Mosaic or Arteor function



Black

10

0 772 32

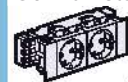

2 x 2 P+E

10

0 772 33



3 x 2 P+E

10

0 794 81



**Cat.6 UTP**  
1 module

10

0 794 85



**Cat.6 FTP**  
2 modules

10

0 794 86



**Cat.6 STP**  
2 modules

10

0 757 86



**Soluclip accessory**

For installation with any Mosaic or Arteor function

# Snap-on DLP trunking black edition – 45 mm cover 50 x 80 and 50 x 130

Cat.Nos for trunking 50 x 80

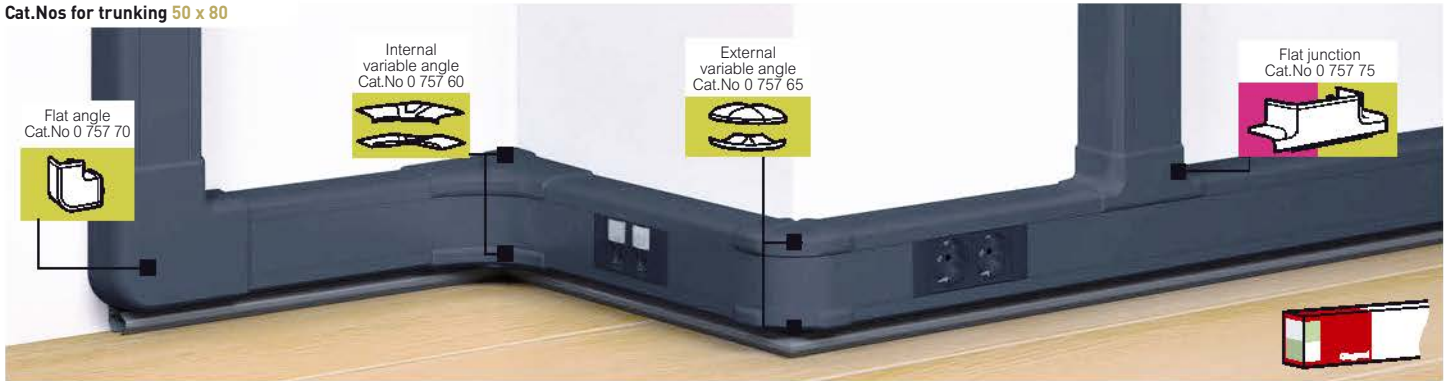

Cat.Nos for trunking 50 x 130



Selection chart p. 742-743

Pack	Cat.Nos	Snap-on trunking "Black edition"
20'	50 x 80 0 757 50	Can take any Mosaic or Arteor wiring accessory Length: 2 m <b>50 x 80 snap-on trunking</b> 1-compartment trunking Includes: 1 body, 1 cover width 45
12'	50 x 130 0 757 52	<b>50 x 130 snap-on trunking</b> 2-compartment trunking Includes: 1 body with 2 compartments, 2 covers width 45
10   5	50 x 80 0 757 60	<b>Angles for snap-on trunking "Black edition"</b>  Internal angle, varies from 80° to 100°  External angle, varies from 85° to 120°  Flat angle at 90°
10   5	0 757 65	
10   5	0 757 70	
10   5	50 x 80 0 757 55	<b>End cap for snap-on trunking "Black edition"</b>  Left or right end cap

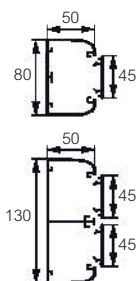

Pack	Cat.Nos	Flat junctions
5	Black 0 757 75	 With 80 and 130 mm wide sections Creates a junction with snap-on trunking 50 x 80 mm
20'	Black 0 757 79	<b>Extra cover</b>  Width 45 mm Length 2 m
26'	White 0 756 09	<b>Extra partition</b>  Divider Length 2 m
20	Black 0 757 80	<b>Joint</b>  Stick-on body joint
10	Black 0 757 85	<b>Cover joint</b>  Width 45 mm

1: Number of meters in pack



# Quick and simplified installation

Save time with the installation thanks to the snap-on trunking system

### Main benefits

- Quick and easy installation thanks to flexible cover and finishing accessories
- Can be equipped with power and data sockets for snap-on trunking
- Tap-off accessories for easy connection of socket units



- 5 sizes supplied complete: body + cover + dividers



- Sockets with Soluclip guaranteed anti-pullout, see opposite



- Up to 3 compartments to be equipped with Mosaic or Arteur wiring accessories

## LEARN MORE



[www.export.legrand.com](http://www.export.legrand.com)



Workstation solutions guide



Pack	Cat.Nos	Sockets for snap-on trunking
		Sockets with connection at both sides for snap-on mounting on trunking with 45 mm cover. Particularly suitable for installation on snap-on trunking (p. 747 to 749). The sockets incorporate the Soluclip accessory to hold the socket in place and comply with the standard. Connected with automatic terminals.
		<b>Standard and tamperproof sockets</b> German Standard
10	0 772 02 (White)   0 772 22 (Tamperproof)	2 x 2P+E
10	0 772 03 (White)   0 772 23 (Tamperproof)	3 x 2P+E
		<b>Red sockets</b> German Standard Sockets with red finish for identification of dedicated circuits
10	0 772 42 (Red)	2 X 2P+E at an angle of 45°
10	0 772 43 (Red)	3 X 2P+E at an angle of 45°
5	0 765 46 (White)	<b>Cat. 6 FTP - RJ 45 sockets</b> FTP - 9-pin, 2 RJ 45, equipped with the Soluclip accessory 3-gang
5	0 765 42 (White)	<b>Cat. 5e FTP - RJ 45 sockets</b> FTP - 9-pin, 2 RJ 45, equipped with the Soluclip accessory 3-gang
		<b>Quick tap-off accessory</b>
10	0 771 06 (White)	For quick, simple tap-off between 2 socket blocks for trunking. Fitted with a cover.
		<b>Soluclip accessory</b>
10	0 756 90 (White)	For installation with any snap-on function. Offers features such as anti-slip, anti-pullout, perfect cover finish, IP 40.

# Snap-on DLP trunking - 45 mm cover 50 x 80 and 50 x 105

## routing sections and accessories

### Cat.Nos for trunking 50 x 80



### Cat.Nos for trunking 50 x 105



Selection chart **p. 742-743**  
 Wiring capacity chart **see e-catalogue**

Pack	Cat.Nos	Snap-on trunking	Angles												
20'   12'	50 x 80 0 756 01   50 x 105 0 756 02	<b>1-compartment trunking</b> Snap-on trunking Can take any Mosaic or Arteor wiring accessory Includes: - 1 body - 1 cover, width 45 mm Length 2 m	<table border="1"> <thead> <tr> <th>Pack</th> <th>Cat.Nos</th> <th>Angles</th> </tr> </thead> <tbody> <tr> <td>10</td> <td>50 x 80 0 756 21   50 x 105 0 756 22</td> <td> Internal angle, varies from 80° to 100°</td> </tr> <tr> <td>10</td> <td>0 756 31   0 756 32</td> <td> External angle, varies from 85° to 120°</td> </tr> <tr> <td>10</td> <td>0 756 41   0 756 42</td> <td> Flat angle at 90°</td> </tr> </tbody> </table>	Pack	Cat.Nos	Angles	10	50 x 80 0 756 21   50 x 105 0 756 22	Internal angle, varies from 80° to 100°	10	0 756 31   0 756 32	External angle, varies from 85° to 120°	10	0 756 41   0 756 42	Flat angle at 90°
Pack	Cat.Nos	Angles													
10	50 x 80 0 756 21   50 x 105 0 756 22	Internal angle, varies from 80° to 100°													
10	0 756 31   0 756 32	External angle, varies from 85° to 120°													
10	0 756 41   0 756 42	Flat angle at 90°													
20'	0 756 08	<b>Extra cover</b> Width 45 mm Length 2 m	<table border="1"> <thead> <tr> <th>Pack</th> <th>Cat.Nos</th> <th>End caps</th> </tr> </thead> <tbody> <tr> <td>10</td> <td>50 x 80 0 756 11   50 x 105 0 756 12</td> <td> Left or right end cap</td> </tr> </tbody> </table>	Pack	Cat.Nos	End caps	10	50 x 80 0 756 11   50 x 105 0 756 12	Left or right end cap						
Pack	Cat.Nos	End caps													
10	50 x 80 0 756 11   50 x 105 0 756 12	Left or right end cap													
26'	0 756 09	<b>Extra partition</b> Divider Length 2 m	<table border="1"> <thead> <tr> <th>Pack</th> <th>Cat.Nos</th> <th>Flat junctions</th> </tr> </thead> <tbody> <tr> <td>5</td> <td>50 x 80 0 756 71   50 x 105 0 756 72</td> <td><b>With 80 mm wide sections</b>  Creates a junction with snap-on trunking 50 x 80 mm</td> </tr> <tr> <td>5</td> <td>50 x 105 0 756 76</td> <td><b>With 105 mm wide sections</b>  Creates a junction with snap-on trunking 50 x 105 mm</td> </tr> </tbody> </table>	Pack	Cat.Nos	Flat junctions	5	50 x 80 0 756 71   50 x 105 0 756 72	<b>With 80 mm wide sections</b> Creates a junction with snap-on trunking 50 x 80 mm	5	50 x 105 0 756 76	<b>With 105 mm wide sections</b> Creates a junction with snap-on trunking 50 x 105 mm			
Pack	Cat.Nos	Flat junctions													
5	50 x 80 0 756 71   50 x 105 0 756 72	<b>With 80 mm wide sections</b> Creates a junction with snap-on trunking 50 x 80 mm													
5	50 x 105 0 756 76	<b>With 105 mm wide sections</b> Creates a junction with snap-on trunking 50 x 105 mm													
10	50 x 80 0 756 61   50 x 105 0 756 62	<b>Fishplate body joint</b> Used to join 2 bodies and simplifies fixing sections to the wall - set of 2	<table border="1"> <thead> <tr> <th>Pack</th> <th>Cat.Nos</th> <th>Angled junction</th> </tr> </thead> <tbody> <tr> <td>5</td> <td>0 756 81</td> <td> Creates a junction in an internal angle with snap-on trunking 50 x 80 mm, 50 x 105 mm, 50 x 130 mm Must be used in conjunction with internal angle</td> </tr> </tbody> </table>	Pack	Cat.Nos	Angled junction	5	0 756 81	Creates a junction in an internal angle with snap-on trunking 50 x 80 mm, 50 x 105 mm, 50 x 130 mm Must be used in conjunction with internal angle						
Pack	Cat.Nos	Angled junction													
5	0 756 81	Creates a junction in an internal angle with snap-on trunking 50 x 80 mm, 50 x 105 mm, 50 x 130 mm Must be used in conjunction with internal angle													
20	0 756 66   0 756 67	<b>Joint</b> Stick-on body joint	<table border="1"> <thead> <tr> <th>Pack</th> <th>Cat.Nos</th> <th>Junction with floor duct</th> </tr> </thead> <tbody> <tr> <td>5</td> <td>0 756 88</td> <td> Creates a junction with a floor duct size 50 x 12 mm or 92 x 20 mm</td> </tr> </tbody> </table>	Pack	Cat.Nos	Junction with floor duct	5	0 756 88	Creates a junction with a floor duct size 50 x 12 mm or 92 x 20 mm						
Pack	Cat.Nos	Junction with floor duct													
5	0 756 88	Creates a junction with a floor duct size 50 x 12 mm or 92 x 20 mm													
10	0 756 69	<b>Cover joint</b> Cover joint, width 45 mm													
24'	0 105 80	<b>Height spacer</b> Length 2 m, colour charcoal grey For fitting 15 mm from the ground													
10	0 756 90	<b>Soluclip accessory</b> For installation with any Mosaic or Arteor function													

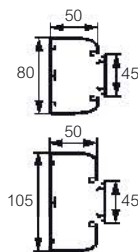

1: Number of metres in pack

# Snap-on DLP trunking - 45 mm cover 50 x 130 and 50 x 145

## routing sections and accessories

Cat.Nos for trunking 50 x 130



Cat.Nos for trunking 50 x 145



Selection chart **p. 742-743**  
Wiring capacity chart **see e-catalogue**

Pack	Cat.Nos	Snap-on trunking
12'   8'	50 x 130 0 756 03   50 x 145 0 756 04	<b>2-compartment trunking</b> Snap-on trunking Can take any Mosaic or Arteor wiring accessory Includes: - 1 body with 2 compartments - 2 covers, width 45 mm Length 2 m
20'	0 756 08	<b>Extra cover</b> Width 45 mm Length 2 m
10	50 x 130 0 756 61   50 x 145 0 756 63	<b>Fishplate body joint</b> Used to join 2 bodies and simplifies fixing sections to the wall - set of 2
20	0 756 66	<b>Stick-on body joint</b> For top part of body
20	50 x 145 0 756 67	For bottom part of body
10	0 756 69	<b>Cover joint</b> Cover joint, width 45 mm
24'	0 105 80	<b>Height spacer</b> Length 2 m, colour charcoal grey For fitting 15 mm from the ground
10	0 756 90	<b>Soluclip accessory</b> For installation with any Mosaic or Arteor function

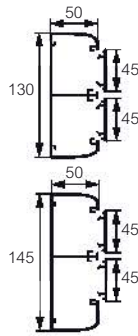

Pack	Cat.Nos	Angles
5	50 x 130 0 756 23   50 x 145 0 756 24	Internal angle, varies from 80° to 100°
5	0 756 33   0 756 34	External angle, varies from 85° to 120°
5	0 756 43   0 756 44	Flat angle at 90°
5	50 x 130 0 756 13   50 x 145 0 756 14	<b>End caps</b> Left or right end cap
5	50 x 130 0 756 71   50 x 145 0 756 72	<b>Flat junctions</b> <b>For 80 mm wide downward trunking</b> Creates a junction with snap-on trunking 50 x 80 mm
5	0 756 71	<b>For 80 mm wide upward trunking</b> Creates a junction with snap-on trunking 50 x 80 mm
5	0 756 75   0 756 76	<b>For 105 mm wide downward trunking</b> Creates a junction with snap-on trunking 50 x 105 mm
5	0 756 75	<b>For 105 mm wide upward trunking</b> Creates a junction with snap-on trunking 50 x 105 mm
5	0 756 81	<b>Angled junction</b> Creates a junction in an internal angle with snap-on trunking 50 x 80 mm, 50 x 105 mm, 50 x 130 mm Must be used in conjunction with internal angle
5	0 756 88	<b>Junction with floor duct</b> Creates a junction with a floor duct size 50 x 12 mm or 92 x 20 mm

1: Number of metres in pack

# Snap-on DLP trunking 45 mm cover 50 x 180

## routing sections and accessories

Cat.Nos for trunking 50 x 180

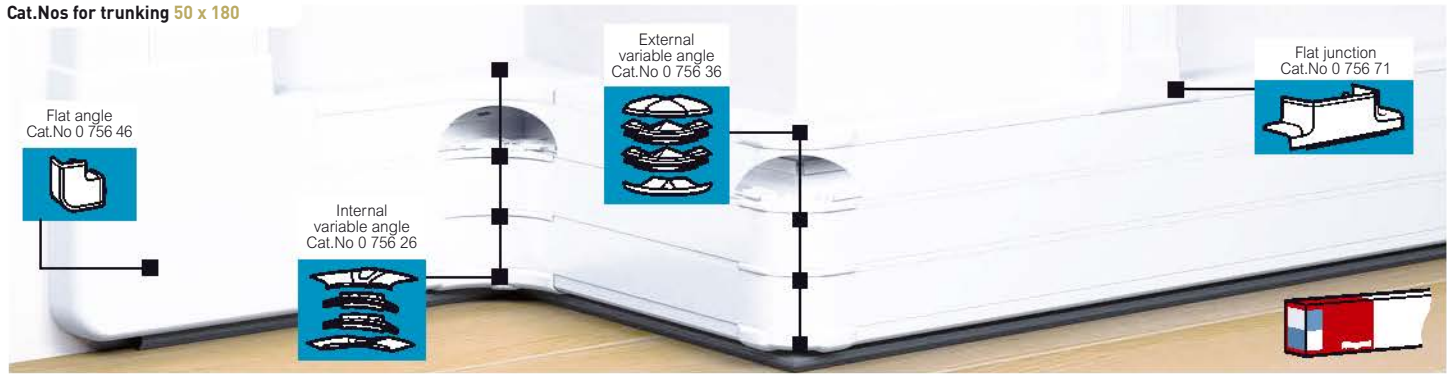

**Example of installation:**  
One current type per compartment



**Example of installation:**  
Wiring accessories in central compartment and distribution in side compartments



Selection chart **p. 742-743**  
Wiring capacity chart **see e-catalogue**

Pack	Cat.Nos	Snap-on trunking
8'	50 x 180 0 756 06	<b>3-compartment trunking</b> Snap-on trunking Can take any Mosaic or Arteor wiring accessory Includes: - 1 body with 3 compartments - 3 flexible covers, width 45 mm Length 2 m
20'	0 756 08	<b>Extra cover</b> Width 45 mm Length 2 m
10	0 756 61	<b>Fishplate body joint</b> Used to join 2 bodies and simplifies fixing sections to the wall - set of 2
20	0 756 66	<b>Stick-on body joints</b> For top part of body
10'	0 756 69	<b>Cover joint</b> Cover joint, width 45 mm
24	0 105 80	<b>Height spacer</b> Length 2 m, colour charcoal grey For fitting 15 mm from the ground
10	0 756 90	<b>Soluclip accessory</b> For installation with any Mosaic or Arteor function

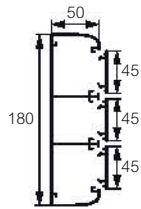

Pack	Cat.Nos	Angles
5	50 x 180 0 756 26	Internal angle, varies from 80° to 100°
5	0 756 36	External angle, varies from 85° to 120°
5	0 756 46	Flat angle at 90°
5	0 756 16	<b>End cap</b> Left or right end cap
5	0 756 71	<b>Flat junctions</b> <b>With 80 mm wide sections</b> Creates a junction with snap-on trunking 50 x 80 mm
5	0 756 75	<b>With 105 mm wide sections</b> Creates a junction with snap-on trunking 50 x 105 mm
5	0 756 81	<b>Angled junction</b> Creates a junction in an internal angle with snap-on trunking 50 x 80 mm, 50 x 105 mm, 50 x 130 mm Must be used in conjunction with internal angle
5	0 756 88	<b>Junction with floor duct</b> Creates a junction with a floor duct size 50 x 12 mm or 92 x 20 mm

1: Number of metres in pack

Cat.Nos for trunking 50 x 80



Cat.Nos for trunking 50 x 130



Technical characteristics [see e-catalogue](#)

Pack	Cat.Nos	<b>Snap-on trunking 50 x 80 and 50 x 130</b>
20 <sup>1</sup>	50 x 80 0 758 00	<b>1-compartment snap-on trunking</b> Can take any Mosaic or Arteor wiring accessory Includes: - 1 body - 1 cover, width 45 mm Length 2 m
12 <sup>1</sup>	50 x 130 0 758 02	<b>2-compartment snap-on trunking</b> Can take any Mosaic or Arteor wiring accessory Includes: - 1 body with 2 compartments - 2 covers, width 45 mm Length 2 m
20 <sup>1</sup>	0 758 29	<b>Extra cover</b> Width 45 mm Length 2 m
26 <sup>1</sup>	50 x 80 0 756 09	<b>Extra partition</b> Divider for 50 x 80 trunking Length 2 m
10	0 758 30	<b>Fishplate body joint</b> Used to join 2 bodies and simplifies fixing sections to the wall - set of 2
20	0 758 33	<b>Joint</b> Stick-on body joint
10	0 758 35	<b>Cover joint</b> Cover joint, width 45 mm

1: Number of metres in pack

Pack	Cat.Nos	<b>Angles</b>
10   5	50 x 80 0 758 10	Internal angle, varies from 80° to 120° External angle, varies from 80° to 120° Flat angle at 90°
10   5	50 x 130 0 758 12	
10   5	0 758 15 0 758 17	
10   5	0 758 20 0 758 22	
10   5	50 x 80 0 758 05	<b>End caps</b> Left or right end cap
10   5	50 x 130 0 758 07	
5	0 758 25	<b>Flat junction</b> Creates a junction with trunking 50 x 80 mm
10	0 758 36	<b>Soluclip accessory</b> For installation with any Mosaic or Arteor function



# Snap-on DLP trunking, grey - 45 mm cover 50 x 180



Cat.Nos for trunking 50 x 180

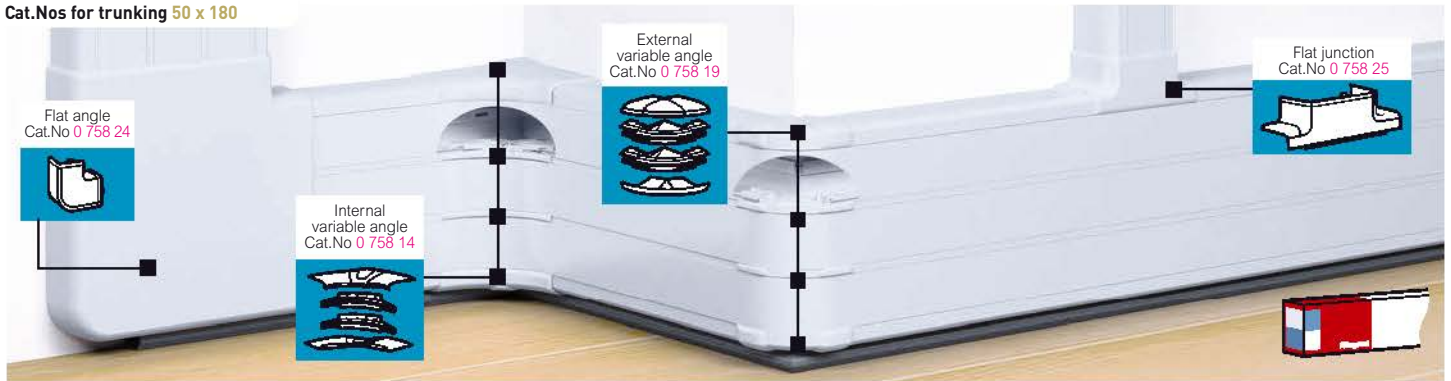

Technical characteristics **see e-catalogue**

Pack	Cat.Nos	<b>Snap-on trunking 50 x 180</b>
8'	<b>50 x 180</b> 0 758 04	<b>3-compartment snap-on trunking</b> Can take any Mosaic or Arteor wiring accessory Includes: - 1 body with 3 compartments - 3 covers, width 45 mm Length 2 m
20'	0 758 29	<b>Extra cover</b> Width 45 mm Length 2 m
10	0 758 30	<b>Fishplate body joint</b> Used to join 2 bodies and simplifies fixing sections to the wall - set of 2
20	0 758 33	<b>Joint</b> Stick-on body joint
10	0 758 35	<b>Cover joint</b> Cover joint, width 45 mm

1: Number of metres in pack

Pack	Cat.Nos	<b>Angles</b>
5	<b>50 x 180</b> 0 758 14	Internal angle, varies from 80° to 120°
5	0 758 19	External angle, varies from 80° to 120°
5	0 758 24	Flat angle at 90°
5	0 758 09	<b>End caps</b> Left or right end cap
5	0 758 25	<b>Flat junction</b> Creates a junction with trunking 50 x 80 mm
10	0 758 36	<b>Soluclip accessory</b> For installation with any Mosaic or Arteor function



Sockets for snap-on DLP trunking, **p. 746**

# Universal DLP trunking

bodies and finishing accessories

White  
length: 2 m

TRUNKING			TRUNKING AND ACCESSORIES						ANGLES		
Number of compartments	Covers width (mm)	Size (mm)	Body and covers complete	Separation	Clips	Base joints <sup>(1)</sup>	Cover joints	End cap	Internal angle <sup>(2)</sup> 85 to 95°	External angle <sup>(2)</sup> 60 to 120°	Flat angle
<b>UNIVERSAL DLP TRUNKING - 65 mm COVER</b>											
1		50 x 80	0 104 62	0 105 82	0 106 81	0 106 92 or 0 106 91	0 108 01	0 107 22	0 106 02	0 106 22	0 107 67
		50 x 105	0 104 24	0 105 82	0 106 81	0 106 96	0 108 01	0 107 00	0 106 05	0 106 19	0 107 86
2		50 x 150	0 104 27	0 105 82	0 106 81	0 106 92 or 0 106 91	2 x 0 108 01	0 107 03	0 106 06	0 106 35	0 107 89
3		50 x 170	0 104 67	0 105 82	0 106 82	0 106 92 or 0 106 91	2 x 0 108 00 + 0 108 01	0 107 10	0 106 50	0 106 38	0 107 98
<b>UNIVERSAL DLP TRUNKING - 85 mm COVER</b>											
1		35 x 105	0 104 63	0 105 82	0 106 82	0 106 92 or 0 106 91	0 108 02	0 107 01	0 106 01	0 106 21	0 107 84
		50 x 105	0 104 64	0 105 82	0 106 82	0 106 92 or 0 106 91	0 108 02	0 107 02	0 106 02	0 106 22	0 107 85
2		50 x 195	0 104 70	0 105 82	0 106 82	0 106 92 or 0 106 91	2 x 0 108 02	0 107 11	0 106 06	0 106 35	0 107 92

1: 0 106 92: base joint for aligning bases, 0 106 91: base joint, attached with adhesive  
2: Internal and external angles include partition junction(s) for installation with multi-compartment trunking

# Universal DLP trunking

wiring accessories supports and back boxes

SUPPORTS FOR ARTEOR AND MOSAIC		Cover width		UNIVERSAL SUPPORTS FOR 60 mm FIXING CENTRES WIRING ACCESSORIES (Galea, Valena, Niloé)		Cover width		BACK BOXES FOR BRITISH STANDARD RANGES (Belanko, Mallia, Synergy)			
		65 mm	85 mm			85 mm				Depth 25 mm	Depth 35 mm
2 modules		0 109 52	0 109 92	1 gang		0 109 13		1 gang		6 208 16	6 208 17
4 modules		0 109 54	0 109 94	2 gang		0 109 23		2 gang		6 208 26	6 208 27
6 modules		0 109 56	0 109 96	3 gang		0 109 33					
8 modules		0 109 58	0 109 98								

## Universal DLP trunking

### junctions

Size (mm)	FLAT JUNCTIONS					ANGLED JUNCTIONS		
	Flat junctions to width 80 mm	Flat junctions to width 105 mm			Flat junctions			
	With 65 mm cover	With 85 mm cover		With 65 mm cover	With same trunking	With 85 mm cover		With 65 mm cover
50 x 80	35 x 105	50 x 105	50 x 105	35 x 105		50 x 105	50 x 105	
50 x 80  Cat.No 0 104 62	0 107 35	-	-	-	0 107 35	-	-	-
50 x 105  Cat.No 0 104 24	0 107 39	0 107 40	-	0 107 40	0 107 40	0 107 65 + 0 106 05	0 107 65 + 0 106 05	0 107 65 + 0 106 05
50 x 150  Cat.No 0 104 27	0 107 35	0 107 36	0 107 36	0 107 37	0 107 32 x 2	0 107 63 + 0 106 06	0 107 63 + 0 106 06	0 107 63 + 0 106 06
50 x 170  Cat.No 0 104 67	0 107 35	0 107 36	0 107 36	0 107 37	0 107 32 x 2	0 107 63 + 0 106 50	0 107 63 + 0 106 50	0 107 63 + 0 106 50
35 x 105  Cat.No 0 104 63	-	-	-	-	0 107 36	-	-	-
50 x 105  Cat.No 0 104 64	0 107 35	0 107 36	0 107 36	0 107 37	0 107 36	0 107 63 + 0 106 02	0 107 63 + 0 106 02	0 107 63 + 0 106 02
50 x 195  Cat.No 0 104 70	0 107 35	0 107 36	0 107 36	0 107 37	0 107 32 x 2	0 107 63 + 0 106 06	0 107 63 + 0 106 06	0 107 63 + 0 106 06

## Universal DLP trunking

### wiring accessories

MOSAIC SOCKET OUTLETS - GERMAN STANDARD					MOSAIC SOCKET OUTLETS - GERMAN STANDARD				
		Standard	Red	Tamperproof			Standard	Red	Tamperproof
<b>AUTOMATIC TERMINALS</b>					<b>SCREW TERMINALS</b>				
2P+E, 2 modules		0 774 01	-	0 774 21	2P+E, 2 modules		0 776 01	-	0 776 21
2 x 2P+E, 4 modules		0 774 02	0 774 12	0 774 22	2 x 2P+E, 4 modules		0 776 02	0 776 12	0 776 22
3 x 2P+E, 6 modules		0 774 03	0 774 13	0 774 23	3 x 2P+E, 6 modules		0 776 03	0 776 13	0 776 23
4 x 2P+E, 8 modules		0 774 04	-	0 774 24	4 x 2P+E, 8 modules		0 776 04	-	0 776 24
<b>AUTOMATIC TERMINALS WIELAND</b>									
2 x 2P+E, 4 modules		4 500 00	4 500 02	-					
3 x 2P+E, 6 modules		4 500 01	4 500 03	-					
<b>AUTOMATIC TERMINALS WAGO WINSTA</b>									
2 x 2P+E, 4 modules		4 500 04	4 500 06	-					
3 x 2P+E, 6 modules		4 500 05	4 500 07	-					

### Cat.Nos for 50 x 80 trunking

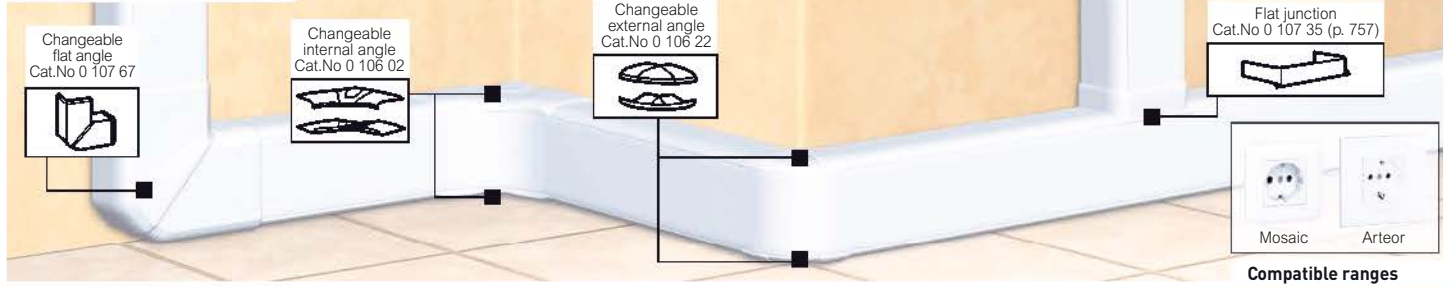

### Cat.Nos for 50 x 105 trunking

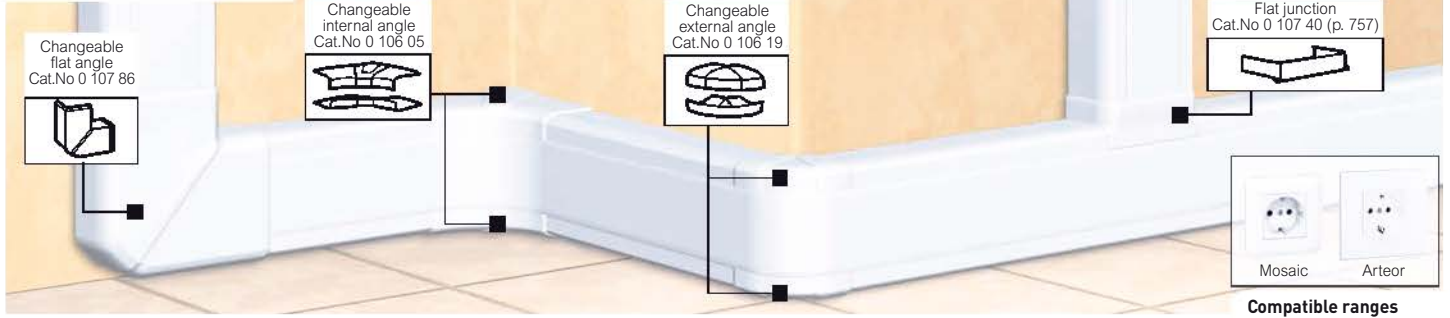

Selection chart **p. 752-753**  
Wiring capacity chart **see e-catalogue**

Pack	Cat.Nos	Universal trunking 50 x 80
20'	0 104 62	<b>Trunking without partition</b> Supplied with: - one 50 x 80 mm body - one flexible 65 mm width cover Fits onto the whole trunking including in internal and external angles Installation: can be used with Mosaic/Arteor ranges or DIN rail equipment Length 2 m
24'	0 105 82	<b>Partition</b> Separation partition Length 2 m
20	0 106 91	<b>Joints</b> Body joint For aligning bases during installation
20	0 106 92	Body joint, attached with adhesive (fit at the end of installation)
10	0 108 01	Cover joint for 65 mm cover

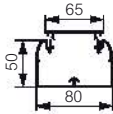

Pack	Cat.Nos	Universal trunking 50 x 105
12'	0 104 24	<b>Trunking without partition</b> Supplied with: - one 50 x 105 mm body - one flexible 65 mm width cover Fits onto the whole trunking including in internal and external angles Installation: can be used with Mosaic/Arteor ranges or DIN rail equipment Length 2 m
24'	0 105 82	<b>Partition</b> Separation partition Length 2 m
20	0 106 96	<b>Joints</b> Body joint For aligning bases during installation
10	0 108 01	Cover joint for 65 mm cover

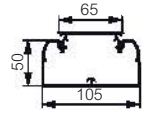

Angles and end cap for universal trunking 50 x 80		
<b>Internal and external bends</b> Include the 2 components for the top and bottom of the trunking on which the flexible cover is fitted		
10	0 106 02	Changeable internal bend, from 85° to 95° for 50 x 80/50 x 105/50 x 150 and 50 x 195 mm trunkings
10	0 106 22	Changeable external bend, from 60° to 120° for 50 x 80/50 x 105/50 x 150 and 50 x 195 mm trunkings
10	0 107 67	<b>Flat angle</b> 90° flat angle
10	0 107 22	<b>End cap</b> Left or right end cap

Angles and end cap for universal trunking 50 x 105		
<b>Internal and external bends</b> Include the 2 components for the top and bottom of the trunking on which the flexible cover is fitted		
10	0 106 05	Changeable internal bend, from 85° to 95° for 50 x 105 mm trunkings
10	0 106 19	Changeable external bend, from 60° to 120° for 50 x 105 mm trunkings
10	0 107 86	<b>Flat angle</b> 90° flat angle
20	0 107 00	<b>End cap</b> Left or right end cap

1: Number of metres in pack

# Universal DLP trunking 50 x 150 and 50 x 170 - 65 mm cover

White  
length: 2 m

## Cat.Nos for 50 x 150 trunking



## Cat.Nos for 50 x 170 trunking

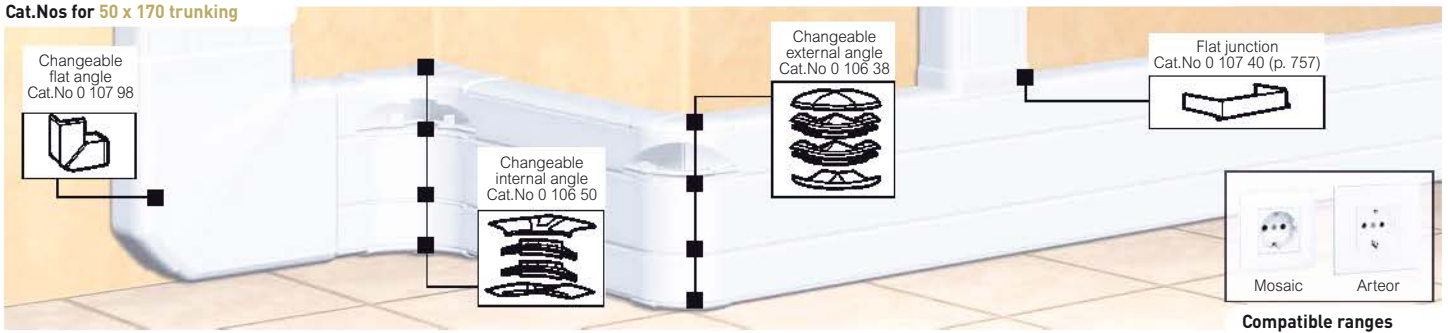

Selection chart **p. 752-753**  
Wiring capacity chart **see e-catalogue**

Pack	Cat.Nos	Universal trunking 50 x 150
12 <sup>1</sup>	0 104 27	<b>Trunking with partition</b> Supplied with: - one 50 x 150 mm body - two flexible 65 mm width covers Fits onto the whole trunking including in internal and external angles Installation: can be used with Mosaic/Arteor ranges or DIN rail equipment Length 2 m
24 <sup>1</sup>	0 105 82	<b>Partition</b> Separation partition Length 2 m
20	0 106 91	<b>Joints</b> Body joint For aligning bases during installation
20	0 106 92	Body joint, attached with adhesive (fit at the end of installation)
10	0 108 01	Cover joint for 65 mm cover

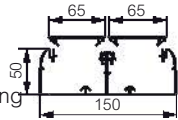

Pack	Cat.Nos	Universal trunking 50 x 170
4 <sup>1</sup>	0 104 67	<b>Trunking with partition</b> Supplied with: - one 50 x 170 mm body - one flexible 65 mm width cover and two flexible 40 mm width covers Fits onto the whole trunking including internal and external angles Installation: can be used with Mosaic/Arteor ranges or DIN rail equipment Length 2 m
24 <sup>1</sup>	0 105 82	<b>Partition</b> Separation partition Length 2 m
20	0 106 91	<b>Joints</b> Body joint For aligning bases during installation
20	0 106 92	Body joint, attached with adhesive (fit at the end of installation)
10	0 108 01	Cover joint for 65 mm cover
10	0 108 00	Cover joint for 40 mm cover

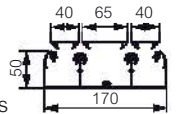

Angles and end cap for universal trunking 50 x 150		
<b>Internal and external bends</b> Include the 3 components making the angle (parts for the top and bottom and the partition junction) on which the flexible cover is fitted		
5	0 106 06	Changeable internal bend, from 85° to 95° for 50 x 150 and 50 x 195 mm trunkings
5	0 106 35	Changeable external bend, from 60° to 120° for 50 x 150 and 50 x 195 mm trunkings
5	0 107 89	<b>Flat angle</b> 90° flat angle
10	0 107 03	<b>End cap</b> Left or right end cap

Angles and end cap for universal trunking 50 x 170		
<b>Internal and external bends</b> Include the 4 components making the angle (parts for the top and bottom and the 2 partition junctions) on which the flexible cover is fitted		
5	0 106 50	Changeable internal bend, from 85° to 95° for 50 x 170 and 50 x 195 mm trunkings
5	0 106 38	Changeable external bend, from 60° to 120° for 50 x 170 and 50 x 195 mm trunkings
2	0 107 98	<b>Flat angle</b> 90° flat angle
5	0 107 10	<b>End cap</b> Left or right end cap

1: Number of metres in pack

### Cat.Nos for 35 x 105 trunking

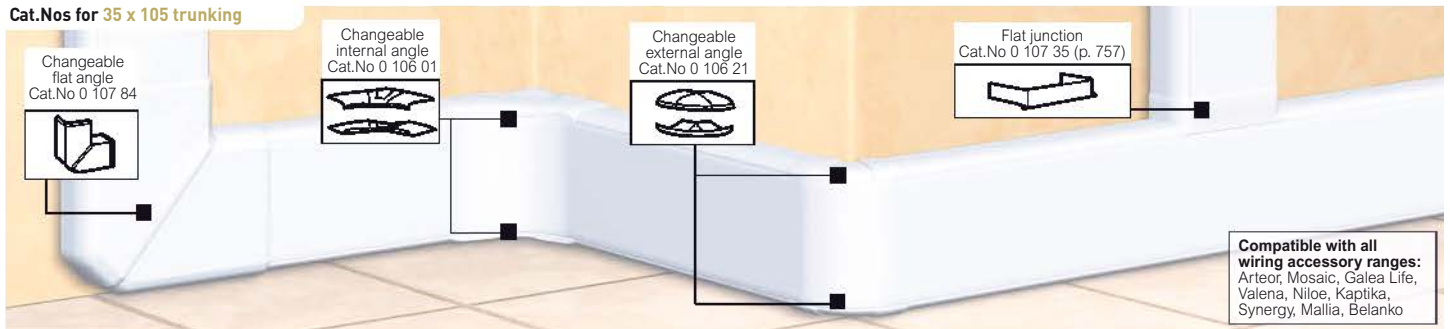

**Compatible with all wiring accessory ranges:**  
Arteor, Mosaic, Galea Life, Valena, Niloe, Kaptika, Synergy, Mallia, Belanko

### Cat.Nos for 50 x 105 trunking

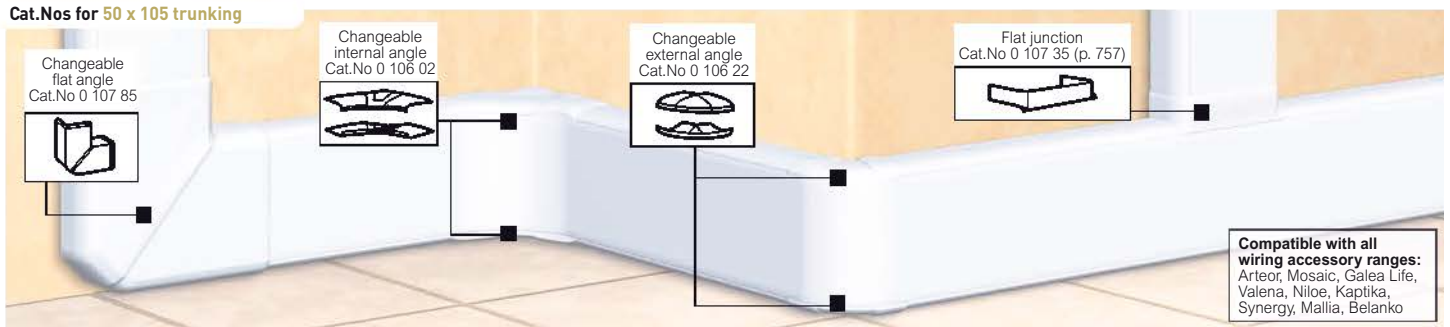

**Compatible with all wiring accessory ranges:**  
Arteor, Mosaic, Galea Life, Valena, Niloe, Kaptika, Synergy, Mallia, Belanko

Selection chart **p. 752-753**  
Wiring capacity chart **see e-catalogue**

Pack	Cat.Nos	Universal trunking 35 x 105
20'	0 104 63	<b>Trunking without partition</b> Supplied with: - one 35 x 105 mm body - one flexible 85 mm width cover Fits onto the whole trunking including in internal and external angles Installation: can be used with Mosaic/Arteor ranges or DIN rail equipment Length 2 m
24'	0 105 82	<b>Partition</b> Separation partition Length 2 m
20	0 106 91	<b>Joints</b> Body joint For aligning bases during installation
20	0 106 92	Body joint, attached with adhesive (fit at the end of installation)
10	0 108 02	Cover joint

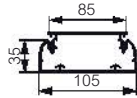

Pack	Cat.Nos	Universal trunking 50 x 105
16'	0 104 64	<b>Trunking without partition</b> Supplied with: - one 50 x 105 mm body - one flexible 85 mm width cover Fits onto the whole trunking including in internal and external angles Installation: can be used with Mosaic/Arteor ranges or DIN rail equipment Length 2 m
24'	0 105 82	<b>Partition</b> Separation partition Length 2 m
20	0 106 91	<b>Joints</b> Body joint For aligning bases during installation
20	0 106 92	Body joint, attached with adhesive (fit at the end of installation)
10	0 108 02	Cover joint

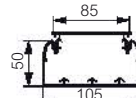

Angles and end cap for universal trunking 35 x 105		
<b>Internal and external bends</b> Include the 2 components for the top and bottom of the trunking on which the flexible cover is fitted		
10	0 106 01	Changeable internal bend, from 85° to 95° for 35 x 80 and 35 x 105 mm trunking
10	0 106 21	Changeable external bend, from 60° to 120° for 35 x 80 and 35 x 105 mm trunking
10	0 107 84	<b>Flat angle</b> 90° flat angle
20	0 107 01	<b>End cap</b> For 35 x 105 mm trunking

Angles and end cap for universal trunking 50 x 105		
<b>Internal and external bends</b> Include the 2 components for the top and bottom of the trunking on which the flexible cover is fitted		
10	0 106 02	Changeable internal bend, from 85° to 95° for 50 x 80/50 x 105/50 x 150 and 50 x 195 mm trunkings
10	0 106 22	Changeable external bend, from 60° to 120° for 50 x 80/50 x 105/50 x 150 and 50 x 195 mm trunkings
10	0 107 85	<b>Flat angle</b> 90° angle For 50 x 105 mm trunking
20	0 107 02	<b>End cap</b> For 50 x 105 mm trunking

1: Number of metres in pack

# Universal DLP trunking 50 x 195 - 85 mm cover

White  
length: 2 m

# Universal DLP trunking junctions and accessories

Cat.Nos for 50 x 195 trunking

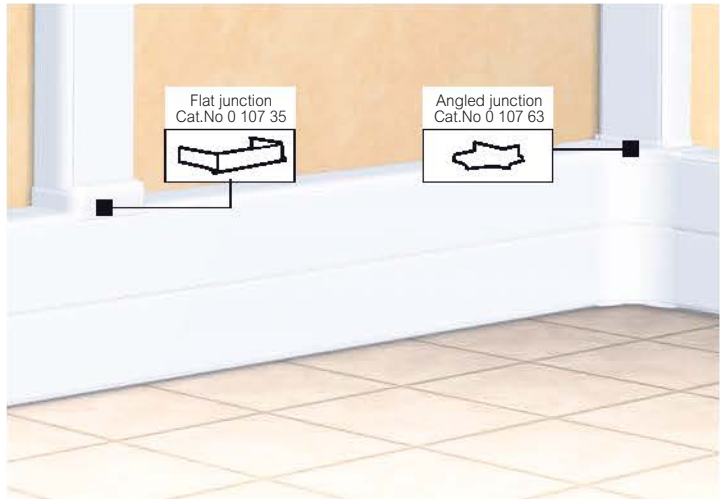
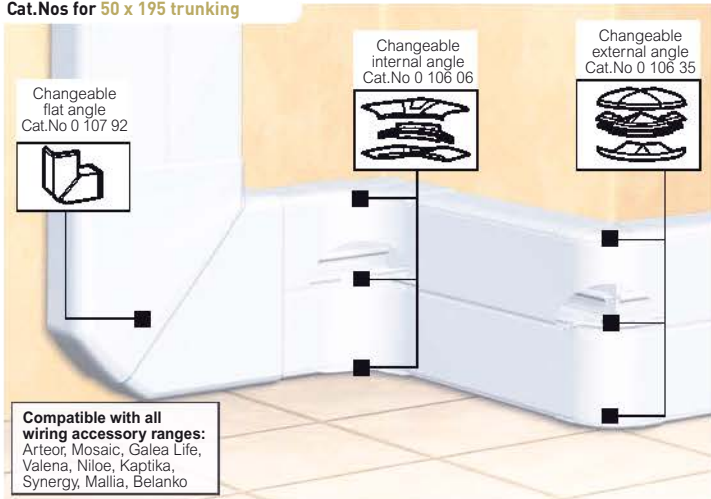

Selection chart p. 752-753  
Wiring capacity chart see e-catalogue

Selection chart p. 752-753

Pack	Cat.Nos	Universal trunking 50 x 195
8'	0 104 70	<b>Trunking with partition</b> Supplied with: - one 50 x 195 mm body - two flexible 85 mm width covers Fits onto the whole trunking including in internal and external angles Installation: can be used with Mosaic/Arteor ranges or DIN rail equipment Length 2 m
24'	0 105 82	<b>Partition</b> Separation partition Length 2 m
20	0 106 91	<b>Joints</b> Body joint For aligning bases during installation
20	0 106 92	Body joint, attached with adhesive (fit at the end of installation)
10	0 108 02	Cover joint
<b>Angles and end cap for universal trunking 50 x 105</b>		
<b>Internal and external bends</b> Include the 3 components making the angle (parts for the top and bottom and the partition junction) on which the flexible cover is fitted		
5	0 106 06	Changeable internal bend, from 85° to 95° for 50 x 150 and 50 x 195 mm trunkings
5	0 106 35	Changeable external bend, from 60° to 120° for 50 x 150 and 50 x 195 mm trunkings
2	0 107 92	<b>Flat angle</b> 90° flat angle
5	0 107 11	<b>End cap</b> Left or right end cap

Pack	Cat.Nos	Junctions
5	0 107 35	<b>Flat junctions</b> For tap-off to a 80 mm wide profile
5	0 107 39	For tap-off to a 80 mm wide profile
5	0 107 37	For tap-off to a 105 mm wide profile equipped with a 65 mm cover
5	0 107 36	For tap-off to a 105 mm wide profile equipped with a 85 mm cover
5	0 107 40	For tap-off to a 150 mm wide profile
<b>Angled junction</b> For tap-off in an internal angle to 35 x 105, 50 x 80, 50 x 105		
5	0 107 63	For use with internal angle Cat.No 0 106 06
5	0 107 65	For use with internal angle Cat.No 0 106 02
<b>Accessories</b>		
50	0 106 82	Clip for 40, 65 and 85 mm covers
50	0 106 81	Clip for 65 mm covers
100	0 308 81	Base for clamp

1: Number of metres in pack

# Mosaic™ Programme socket outlets



Pack	Cat.Nos		Sockets for installation on DLP trunking - German standard	
			Mosaic sockets with shutters with connection at both sides for mounting on 65 and 85 mm cover DLP trunking in conjunction with supports and plates for trunking (see p. 752-753) Direct connection requiring no tools, intuitive disconnection without dismantling the support	
10	White 0 774 01	Tamperproof 0 774 21		2P+E
10	0 774 02	0 774 22		2 x 2P+E
10	0 774 03	0 774 23		3 x 2P+E
5	0 774 04	0 774 24		4 x 2P+E
			<b>Automatic terminals - Wieland</b> Equipped with fast connectors Wieland GST18i3	
10	Red 0 774 11			2P+E
10	0 774 12			2 x 2P+E
10	0 774 13			3 x 2P+E
5	0 774 14			4 x 2P+E
			<b>Automatic terminals - Wago Winsta</b> Equipped with fast connectors Wago Winsta	
2	White 4 500 00	Red 4 500 02		2 x 2P+E
2	4 500 01	4 500 03		3 x 2P+E
2	4 500 04	4 500 06		2 x 2P+E
2	4 500 05	4 500 07		3 x 2P+E

Pack	Cat.Nos		Sockets for installation on DLP trunking - German standard (continued)	
			<b>Screw terminals</b>	
10	White 0 776 01	Tamperproof 0 776 21		2P+E
10	0 776 02	0 776 22		2 x 2P+E
10	0 776 03	0 776 23		3 x 2P+E
5	0 776 04	0 776 24		4 x 2P+E
			<b>Tamperproof insert</b>	
10	Red 0 776 11			2P+E
10	0 776 12			2 x 2P+E
10	0 776 13			3 x 2P+E
5	0 776 14			4 x 2P+E
10	0 502 99			Tamperproof insert for socket Fits directly into the plug



# Wiring accessories supports for DLP trunking



Pack	Cat.Nos	Supports for mounting Mosaic and Arteor wiring accessories
5	0 109 10	Click-on supports which can be fitted side by side Supplied with finishing plate <b>For 40 mm cover</b> 1 module
20	0 109 52	<b>For 65 mm cover</b> 2 modules
20	0 109 54	4 modules
10	0 109 56	6 modules
10	0 109 58	8 modules
20	0 109 92	<b>For 85 mm cover</b> 2 modules
20	0 109 93	3 modules
20	0 109 94	4 modules
10	0 109 96	6 modules
10	0 109 98	8 modules
10	0 109 27	Insulation unit for 2 modules Can be fitted together to create 4, 6 and 8 modules supports

Pack	Cat.Nos	Supports for mounting Mosaic wiring accessories alongside the trunking
10	0 316 21	Use 1 frame plus 1 link accessory plus 1 slide for 35 mm width trunking and add 1 spacer for 50 mm width trunking Mosaic frames For 65, 85 and 130 mm covers 2 x 4 modules
10	0 316 22	3 x 4 modules

Pack	Cat.Nos	Universal supports for 60 mm fixing centres wiring accessories
10	0 109 13	For Galea Life, Valena, Suno, Cariva, Niloe and Kaptika For 85 mm cover 1 gang
5	0 109 23	2 gang
5	0 109 33	3 gang

Pack	Cat.Nos	Mounting of Synergy, Mallia and Belanko wiring accessories
Back boxes for mounting British standard wiring accessories on 85 mm cover		
5	6 208 16	<b>Depth 25 mm</b> 1 gang
5	6 208 26	2 gang
5	6 208 17	<b>Depth 35 mm</b> 1 gang
5	6 208 27	2 gang

Pack	Cat.Nos	Supports for mounting Din-rail equipment wiring accessories
5	0 109 25	<b>For 65 mm cover</b> 2 modules
5	0 109 35	<b>For 85 mm cover</b> 3 modules

# Accessories

## universal DLP trunking



Pack	Cat.Nos	Accessories
1	0 306 98	<b>Cutting accessories for trunking</b> DLPlus cutting unit for PVC DLP For cutting all plastic bodies Avoids vibration when cutting bases and covers. Aluminium Dim.: 225 x 142 x 76 mm
10	0 304 18	<b>Insulation accessory</b> Base joint. Adjustable wall insulation joint, supplied in 5 m lengths Provides continuity between the trunking and the wall, in particular in internal angles
100	0 308 98	<b>Fixing accessories for trunking</b> For fixing all plastic profiles <b>Wall plugs for immediate fixing</b> No screws or nails required For mini-trunking
100	0 308 99	For mini-trunking, skirting trunking and trunking
12	0 309 49	<b>Cartridge of Neoprene</b> Adhesive for glue gun
200	0 308 97	<b>DLP rapid wall plug</b> For 10 mm min. plasterboard walls at least 20 mm away from the concrete surface For fixing DLP plastic trunking in a single operation Used with a special tool for drill (Ø8 mm), supplied in each pack of 200 wall plugs Tensile resistance: 25 kg
100	0 106 95	<b>Spit end cap for DLP trunking</b> For rapid fixing of trunkings with the Spit Pulsa 700 E (use 20 mm Spit nails)
10	0 313 50	<b>Junction boxes for DLP trunking</b> Fitted with current separator Cable entry possible via the bottom of the box <b>White junction boxes</b> Dim.: 163 x 163 x 65 mm (except profile height 80 mm)
5	0 313 51	Dim.: 200 x 200 x 83 mm
5	0 313 52	Dim.: 250 x 250 x 83 mm
5	0 107 80	<b>VDI cable management accessories</b> To be fitted on the standard accessories (angles and junctions). For all trunking sizes except 35 x 80 trunking and in compartments with 40 mm width cover Accessory for internal angle
5	0 107 81	Accessory for external angle
5	0 107 82	Accessory for flat angle
5	0 107 83	Accessory for flat junction

Pack	Cat.Nos	Accessories
10	0 343 98	<b>Junction and routing accessories</b> <b>Base for Nylobloc auto terminals</b> For up to 3 screwless connection terminals Nylobloc auto (Cat.Nos 0 343 22/23/25/28) Direct fixing: - in top of Plexo boxes and industrial plastic cabinets ≥ 130 x 130 mm - on flat bar 12 x 2 mm - in bottom of universal and aluminium DLP trunkings (from 50 x 80 mm) Screw fixing: - in bottom of Plexo boxes ≥ 105 x 105 mm and industrial plastic cabinets - universal Fixing on rail with accessory Cat.No 0 048 11 (p. 180) Accessible test socket Marking zone with felt tip pen Cat.No 0 395 98 (p. 284)
20	0 312 10	<b>Connection strips</b> Connection strips with 4 x 4 mm <sup>2</sup> terminals for junction boxes
100	0 308 81	<b>For high current cables</b> Base for cable ties
10	0 107 32	<b>Flat junctions</b> <b>Base junctions</b> To tap-off to a profile smaller than 50 x 105
5	0 107 33	To tap-off to an 80 mm width trunking
5	0 107 42	<b>Accessories for separation partition</b> Allow bottom compartment cables to pass through the separation partition in case of a flat junction
5	0 107 43	For 50 mm height separation partition
		For 65 mm height separation partition
5	0 107 70	<b>Junctions for change of plane</b> To tap-off from wall to ceiling, for example to supply power to a luminaire
5	0 107 71	For cover 40 mm
5	0 107 72	For cover 65 mm
5	0 107 73	For cover 85 mm For trunking Cat.No 0 104 24
5	0 107 71+ 0 106 90 0 107 72+ 0 106 90	<b>Junctions between floor duct and trunking</b> To tap-off to floor duct Cat.No 0 328 00 (p. 771) For cover 65 mm
5		For cover 85 mm
5	0 106 98	<b>Wall feedthroughs</b> Provides a finish between the trunking and the wall
5	0 106 99	For trunking 80 to 150 mm width For trunking 195 to 220 mm width

## Aluminium adaptable DLP trunking system

			TRUNKINGS AND FITTINGS										
Nber of compart.	Cover width (mm)	Size (mm)	Body	Rigid covers	Separation partitions	Division partition	End cap	Flat angle	External angle	Internal angle	Flat junction	Body joint	Cover joint
1	65 	50 x 105	0 111 14	0 111 10	0 111 08	-	0 111 15	0 112 42	0 112 31	0 112 20	0 112 50	0 111 91	0 111 62
	85 	50 x 105	0 111 00	0 111 11	0 111 08	-	0 111 58	0 112 43	0 112 32	0 112 21	0 112 51	0 111 66 +	0 111 92 0 111 63
	85 	65 x 105	0 111 01	0 111 11	0 111 09	-	0 111 59	0 112 44	0 112 33	0 112 22	0 112 53	0 111 66 +	0 111 92 0 111 63
2	65 65 	50 x 150	0 111 02	2 x 0 111 10	0 111 08	0 111 06	0 111 60	0 112 45	0 112 38	0 112 27	0 112 51	0 111 66 +	0 111 92 0 111 62
	65 65 	65 x 150	0 111 03	2 x 0 111 10	0 111 09	0 111 07	0 111 89	0 112 46	0 112 39	0 112 28	0 112 53	0 111 66 +	0 111 92 0 111 62
	85 85 	50 x 195	0 111 04	2 x 0 111 11	0 111 08	0 111 06	0 111 61	0 112 47	0 112 40	0 112 29	0 112 51	0 111 66 +	0 111 92 0 111 63
	85 85 	65 x 195	0 111 05	2 x 0 111 11	0 111 09	0 111 07	0 111 90	0 112 48	0 112 41	0 112 30	0 112 53	0 111 66 +	0 111 92 0 111 63

## Aluminium adaptable DLP trunking system

### mounting of wiring accessories

MOSAIC AND ARTEOR SUPPORTS - ALUMINIUM				MOSAIC SOCKET OUTLETS - GERMAN STANDARD		
		Cover width		Aluminium	Standard	Tamperproof
		65 mm	85 mm			
2 modules		0 112 02	0 112 12	2 x 2P+E, 4 modules		0 792 82 0 774 22
3 modules		0 112 03	0 112 13	3 x 2P+E, 6 modules		0 792 83 0 774 23
4 modules		0 112 04	0 112 14			
6 modules		0 112 06	0 112 16	<b>MOSAIC RJ 45 SOCKETS</b>		
8 modules		0 112 08	0 112 18	Aluminium		
<b>UNIVERSAL SUPPORTS FOR GALEA LIFE, VALENA, SUNO, etc. ...</b>				UTP		
		Cover width 85 mm		FTP		
1 gang		0 111 67		1 RJ 45 cat. 6		1 mod. 0 794 61 2 mod. 0 794 64
2 gang		0 111 68		1 rear pluggable RJ 45 socket cat. 6 2 modules		0 786 26 0 786 27
3 gang		0 111 69		1 rear pluggable RJ 45 socket cat. 5e 2 modules		0 786 24 0 786 25
4 gangs		0 111 70				

# Aluminium adaptable DLP trunking system 50 x 105 / 65 x 105

Cat.Nos for 50 x 105 trunking

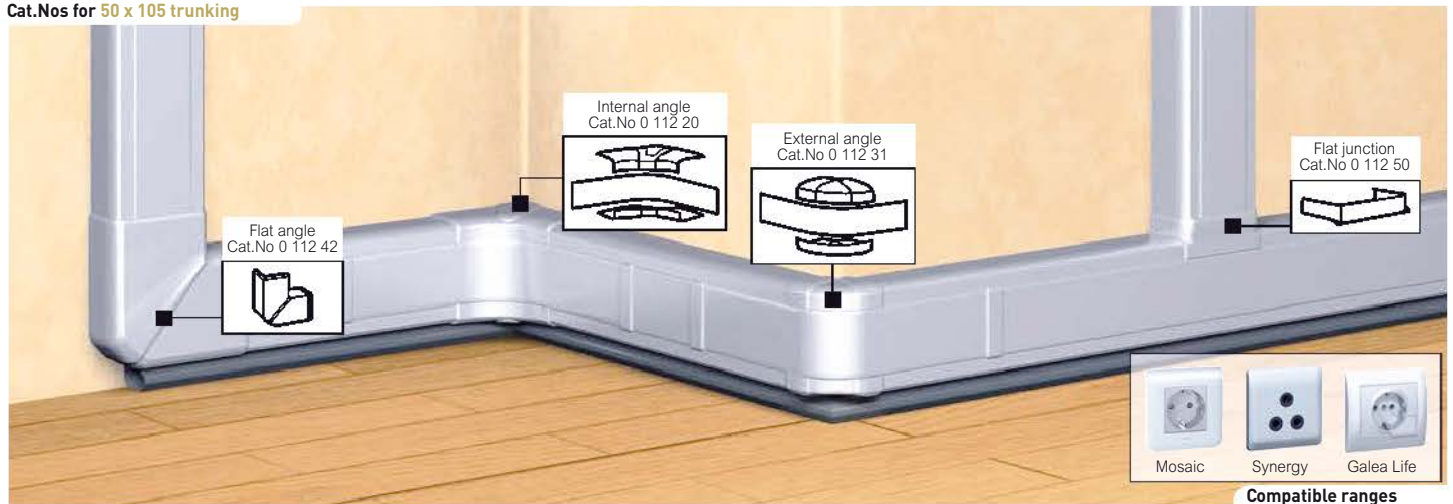

Selection chart **p. 761**  
Technical characteristics **see e-catalogue**

Pack	Cat.Nos	Body
8 <sup>1</sup>	50 x 105 0 111 14	Supplied without cover Length 2 m Cover 65 mm width
<b>Cover and partition</b>		
16 <sup>1</sup>	0 111 10	Full rigid cover 65 mm width
24 <sup>1</sup>	0 111 08	Separation partition
<b>Finishing accessories</b>		
20	50 x 105 0 111 15	End cap
10	0 112 42	Flat angle
1	0 112 31	External angle
1	0 112 20	Internal angle
5	0 112 50	Flat junction
20	0 111 91	Body joint
10	0 111 62	Cover joint for 65 mm cover

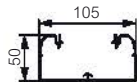

Pack	Cat.Nos	Bodies
8 <sup>1</sup>	50 x 105   65 x 105 0 111 00   0 111 01	Supplied without cover length 2 m Cover 85 mm width
<b>Cover and partition</b>		
16 <sup>1</sup>	0 111 11	Full rigid cover 85 mm width
24 <sup>1</sup>	50 x 105   65 x 105 0 111 08   0 111 09	Separation partition
<b>Finishing accessories</b>		
20   10	50 x 105   65 x 105 0 111 58   0 111 59	End cap
10	0 112 43   0 112 44	Flat angle
1	0 112 32   0 112 33	External angle
1	0 112 21   0 112 22	Internal angle
5	0 112 52   0 112 54	Flat junction For 50 x 105 trunking, cover width 65 mm
5	0 112 51   0 112 53	Flat junction For 50 x 105 trunking, cover width 85 mm
20	0 111 66	Body joint attached with adhesive (fit at the end of installation)
20	0 111 92	For aligning bases during installation
10	0 111 63	Cover joint for 85 mm cover

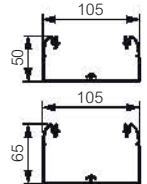

1: Number of metres in pack

# Aluminium adaptable DLP trunking system 50 x 150 / 65 x 150 / 50 x 195 and 65 x 195

Cat.Nos for 50 x 195 trunking

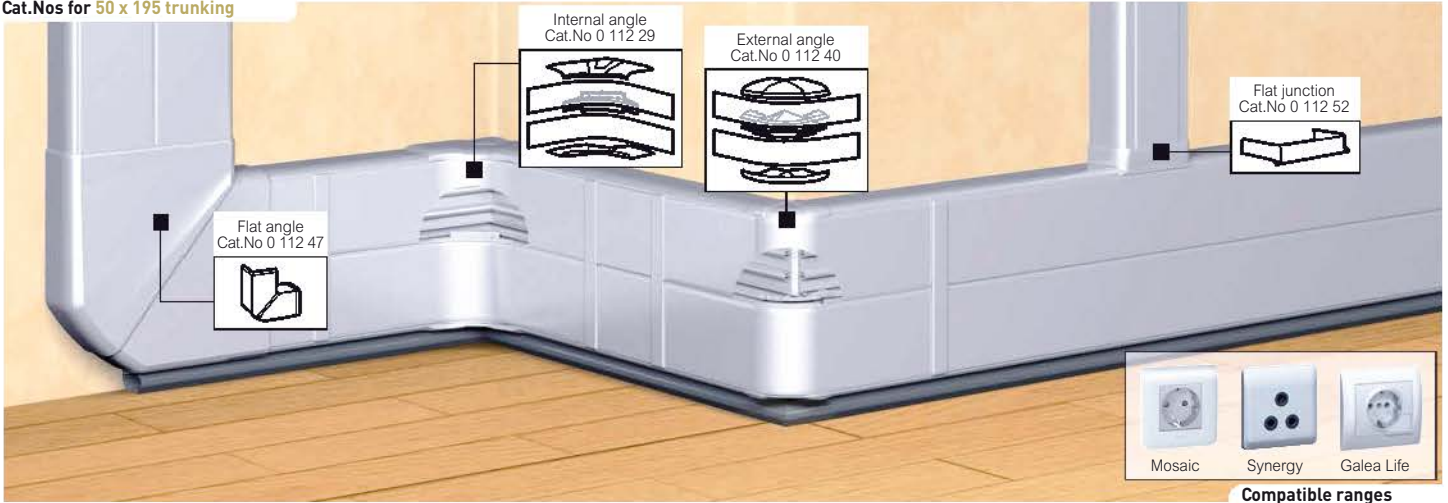

Selection chart **p. 761**  
Technical characteristics **see e-catalogue**

Pack	Cat.Nos	Bodies		Pack	Cat.Nos	Bodies	
4'	50 x 150 0 111 02   65 x 150 0 111 03	Supplied without cover Allow fitting of partial covers length 2 m		4'	50 x 195 0 111 04   65 x 195 0 111 05	Supplied without cover Allow fitting of partial covers length 2 m	
16'	0 111 10	Partial rigid cover 65 mm width Full rigid cover 130 mm width		16'	0 111 11	Partial rigid cover 85 mm width	
8'	0 111 12			24'	0 111 08   65 x 195 0 111 09		
12'	50 x 150 0 111 06   65 x 150 0 111 07	Division partition for cover 65 mm width		12'	0 111 06   65 x 195 0 111 07	Division partition for cover 85 mm width	
24'	0 111 08   0 111 09	Separation partition					
10	50 x 150 0 111 60   65 x 150 0 111 89	<b>Finishing accessories</b>		10   5	50 x 195 0 111 61   65 x 195 0 111 90	<b>Finishing accessories</b>	
		End cap				End cap	
5   2	0 112 45   0 112 46	Flat angle		2	0 112 47   0 112 48	Flat angle	
1	0 112 38   0 112 39	External angle		1	0 112 40   0 112 41	External angle	
1	0 112 27   0 112 28	Internal angle		1	0 112 29   0 112 30	Internal angle	
5	0 112 52   0 112 54	Flat junction 50 x 105 trunking, cover width 65 mm		5	0 112 52   0 112 54	Flat junction 50 x 105 trunking, cover width 65 mm	
5	0 112 51   0 112 53	Flat junction 50 x 105 trunking, cover width 85 mm		5	0 112 51   0 112 53	Flat junction 50 x 105 trunking, cover width 85 mm	
20	0 111 66	Body joint attached with adhesive (fit at the end of installation)		20	0 111 66	Body joint attached with adhesive (fit at the end of installation)	
20	0 111 92	For aligning bases during installation		20	0 111 92	For aligning bases during installation	
10	0 111 62	Cover joint for 65 mm cover		10	0 111 63	Cover joint for 85 mm cover	

1: Number of metres in pack

# Aluminium adaptable DLP trunking system

supports for wiring accessories

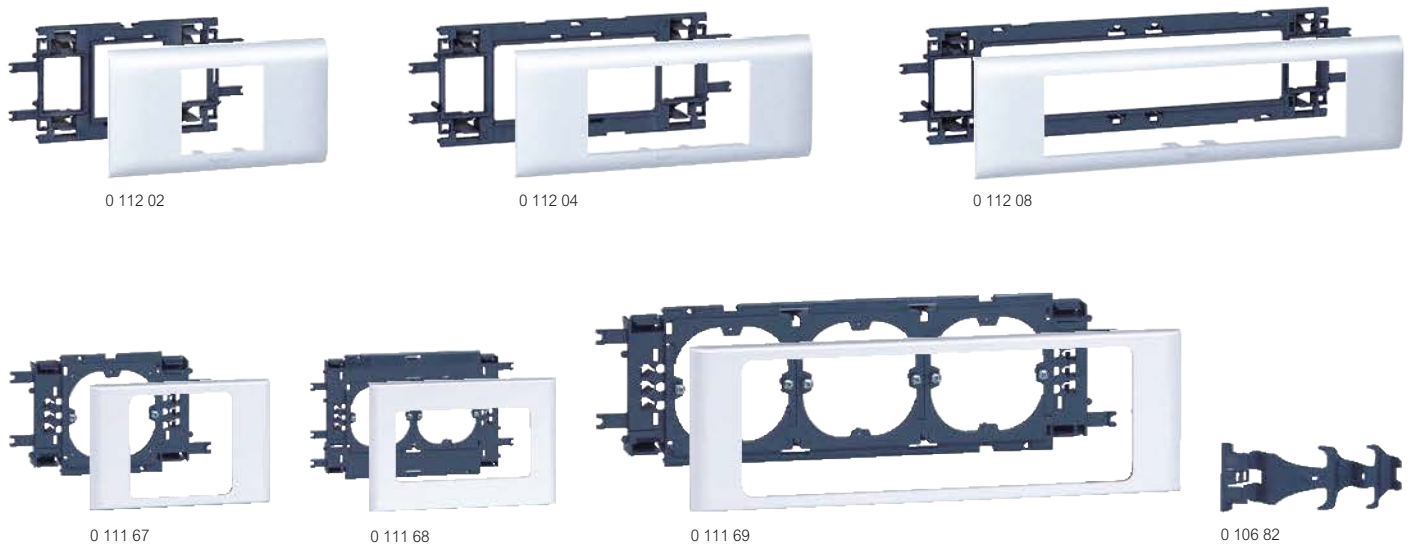

Pack	Cat.Nos	Supports for Mosaic and Arteor wiring accessories
20	0 112 02	<b>For 65 mm width covers</b> 2 modules
20	0 112 03	3 modules
20	0 112 04	4 modules
10	0 112 06	6 modules
10	0 112 08	8 modules
20	0 112 12	<b>For 85 mm width covers</b> 2 modules
20	0 112 13	3 modules
20	0 112 14	4 modules
10	0 112 16	6 modules
10	0 112 18	8 modules

Pack	Cat.Nos	Supports for 60 mm fixing centres wiring accessories
10	0 111 67	<b>For 85 mm width covers</b> 1 gang
5	0 111 68	2 gang
5	0 111 69	3 gang
5	0 111 70	4 gang

Pack	Cat.Nos	Cabling accessories
50	0 106 82	Clip for 40, 65 and 85 mm covers
50	0 106 86	Clip for 130 and 180 mm covers
20	0 111 88	Earth link
100	0 308 81	Base for cable ties

Pack	Cat.Nos	Mounting of Synergy, Mallia and Belanko wiring accessories
<b>Back boxes for mounting British standard wiring accessories on 85 mm cover</b>		
<b>Depth 25 mm</b>		
5	6 208 16	1 gang
5	6 208 26	2 gang
<b>Depth 35 mm</b>		
5	6 208 17	1 gang
5	6 208 27	2 gang

# Snap-on DLP aluminium trunking system



TRUNKING	BODY		ANGLES			ACCESSORIES							
	Body	Cover	Internal angle	External angle	Flat angle	Separation partition		End cap	Cover joint	Fixing clip	Coupling pin	Earth link	
	Aluminium	Aluminium	Plastic (alu finish)			PVC	Aluminium	Plastic (alu finish)	Plastic (alu finish)	Plastic (white)	Plastic (alu finish)	-	-
50 x 85 mm 	6 038 11		6 038 22	6 038 28	6 038 34			6 038 40					
50 x 130 mm 	6 038 13	6 038 17	6 038 24	6 038 30	6 038 36	6 373 58	6 038 47	6 038 42	6 038 19	6 038 57	6 038 58	6 038 59	0 111 88



■ Coupling between two trunking sections



■ Adjustable angles (plastic) between 80° and 120°



■ Example of snap-on DLP aluminium trunking equipped with Mosaic Programme wiring accessories

Cat.Nos for 50 x 130 mm trunking

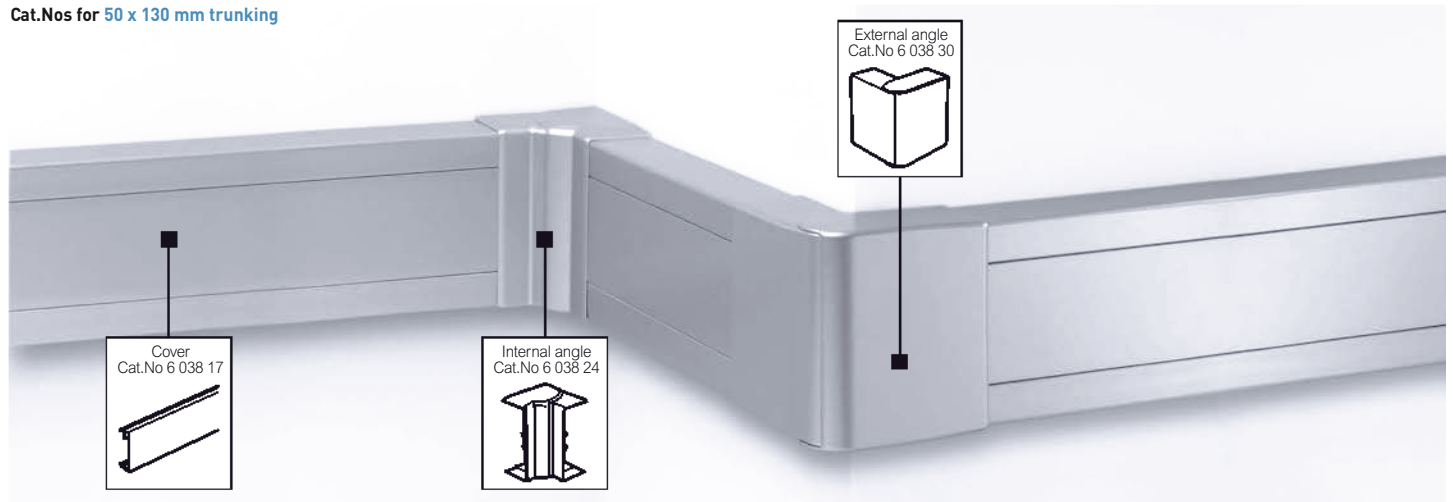

Selection chart p. 765

Pack	Cat.Nos	Snap-on trunking	Angles
24'	50 x 85 6 038 11	<b>1-compartment trunking</b> Snap-on aluminium trunking Can take any Mosaic or Arteor wiring accessory Includes: - 1 body - 1 cover, width 45 mm Length 2 m	10 8 50 x 85 6 038 22
	50 x 130 6 038 13	<b>2-compartment trunking</b> Snap-on aluminium trunking Can take any Mosaic or Arteor wiring accessory Includes: - 1 body with 2 compartments - 2 covers, width 45 mm Length 2 m	10 8 50 x 130 6 038 24
	6 038 17	<b>Extra cover</b> Width 45 mm, Length 2 m	10 8 6 038 28
	6 373 58	<b>Partitions</b> Length 2 m PVC separation partition	10 14 6 038 34
	6 038 47	Aluminium separation partition	10 14 6 038 36
	6 038 19	<b>Cover joint</b> Cover joint PVC Alu finish, width 45 mm	10 50 x 85 6 038 40
	6 038 59	<b>Coupling pin</b> Coupling pin used to join 2 bodies	10 50 x 130 6 038 42
	6 038 57	<b>Fixing clip</b> For Mosaic and Arteor white finish functions	20 0 111 88
	6 038 58	For Mosaic aluminium finish and Arteor magnesium finish functions	

1: Number of metres in pack



## Aluminium snap-on columns



Conform to EN 50085-2-4  
 For distribution of power vertically  
 Power supply via the ceiling and/or the floor  
 To be equipped with Arteor or Mosaic wiring accessories  
 (direct clipping)

Pack	Cat.Nos	Columns
		Consisting of: - Aluminium body and cover - Telescopic pole with height adjustment for installing between false ceiling and ceiling (length 1 m) - Two fixing bases with protective caps - Anodised aluminium cover
		<b>74 x 80 mm - 1 compartment</b>
1	6 038 00	Height 2.70 m Can be adapted to a ceiling height up to 3.70 m
1	6 038 02	Height 3.70 m Can be adapted to a ceiling height up to 4.70 m
		<b>81 x 130 mm - 2 compartments</b>
1	6 038 01	Height 2.70 m Can be adapted to a ceiling height up to 3.70 m
1	6 038 03	Height 3.70 m Can be adapted to a ceiling height up to 4.70 m
		<b>Separation partition for 74 x 80 and 81 x 130 snap-on columns</b>
36	6 038 07	Height 60 mm
		<b>Mini-column</b>
		81 x 130 mm - 2 compartments Can be associated with floor trunking range (p. 771)
1	6 038 05	Height 0.68 m
1	6 038 09	Height 0.30 m

## Aluminium snap-on columns

### Height adjustment

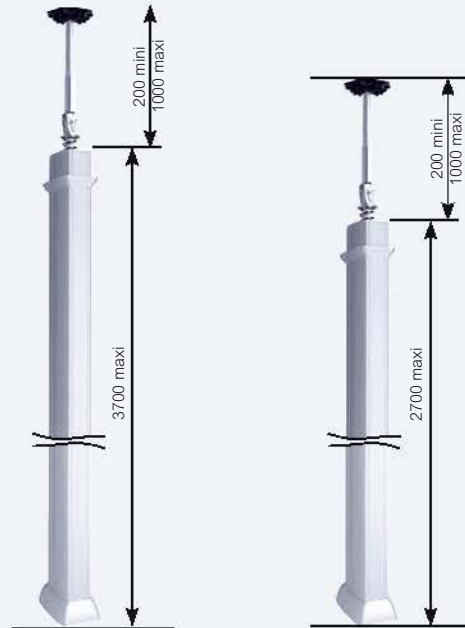

Snap-on column 3.7 m

Snap-on column 2.7 m

### Fixing base

1-compartment columns

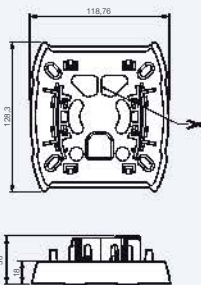

2-compartment columns

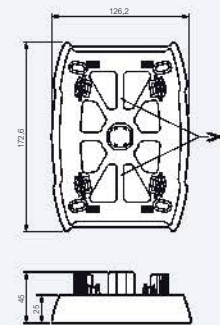

### Wiring capacity

1-compartment columns

Max. capacity of conductors (for each type of conductor)		With 45 mm mechanisms	Without wiring accessories
Cross-section		2916	4150
Wire	1.5 mm <sup>2</sup> Ø3	324	460
	2.5 mm <sup>2</sup> Ø3.5	238	338
Cable	3 x 1.5 mm <sup>2</sup> Ø9	36	51
	3 x 2.5 mm <sup>2</sup> Ø11	24	34
	FTP cat. 6 or coaxial Ø7	59	84

2-compartment columns

Max. capacity of conductors (for each type of conductor)		With 45 mm mechanisms		Without wiring accessories	
Compartment		2	3	2	3
Cross-section		2683	2683	3900	3900
Wire	1.5 mm <sup>2</sup> Ø3	298	298	435	435
	2.5 mm <sup>2</sup> Ø3.5	219	219	319	319
Cable	3 x 1.5 mm <sup>2</sup> Ø9	33	33	48	48
	3 x 2.5 mm <sup>2</sup> Ø11	22	22	32	32
	FTP cat. 6 or coaxial Ø7	54	54	79	79



# Installation freedom and flexibility

Supplied through the false floor or false ceiling, the columns and half-columns guarantee current distribution as closely as possible to the workstation

**Main benefits**

- More practical thanks to the mobile or fixed version of the columns
- Mini-columns with a smaller size for an easier integration in workspaces
- 4 compartments to separate power and data



■ White or Aluminium



■ Mosaic socket outlets



■ Lighting module

**MORE INFORMATION**



[www.export.legrand.com](http://www.export.legrand.com)



E-catalogue



- For distribution of power vertically with the input in separate ducts for high voltage and low voltage cables
- Power supply via the ceiling and/or the floor
- To be equipped with supports for wiring accessories

Pack	Cat.Nos		Columns and half-columns
	Alu	White	Consisting of: - Aluminium body - Telescopic pole with height adjustment for installing between false ceiling and ceiling (length 1.10 m) - Two fixing bases with protective caps - Anodised aluminium or white PVC cover
1	0 307 08	0 307 03	<b>4-compartment columns</b> Height 2.70 m Can be adapted to a ceiling height of 3.80 m
1	0 307 09	0 307 07	Height 3.90 m Can be adapted to a ceiling height of 5 m
1	0 307 27		<b>2-compartment half-columns</b> Height 2.70 m Can be adapted to a ceiling height of 3.80 m
1	0 307 28		Height 3.90 m Can be adapted to a ceiling height of 5 m

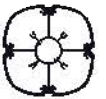

## Lighting modules for columns

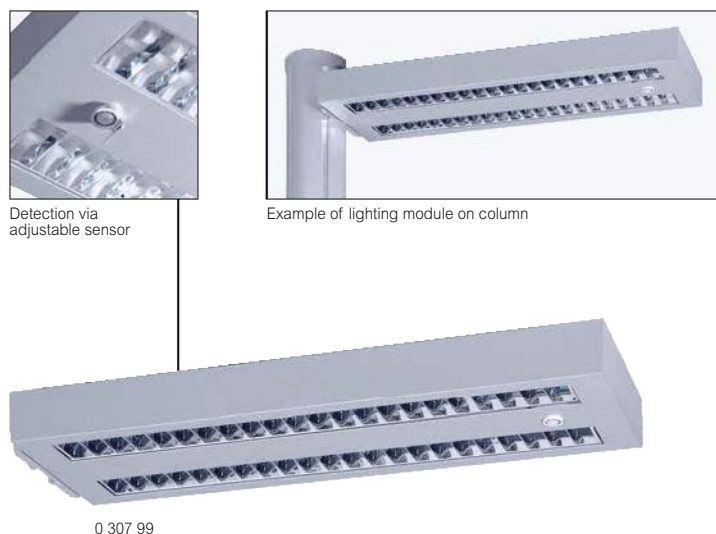

Pack	Cat.Nos	Lighting modules for columns
1	<div style="display: flex; justify-content: space-around;"> <div style="text-align: center;">  Alu 0 307 97                 </div> <div style="text-align: center;">  White 0 307 94                 </div> </div>	<p>For installation on columns Cat.Nos 0 307 03/07/08/09 Conform to EN 60598-1 For two T5 Fluorescent lamps 24 W with 220-240 V electronic ballast, 50-60 Hz Steel frame available in aluminium or white finish Darklight grid: double parabolic, anti-glare, low brightness Equipped with fixing system to adjust the luminaire's tilt angle</p> <p><b>ON/OFF lighting module</b> Enables lighting via one 45 mm auxiliary Mosaic control or presence sensor</p>
1	<div style="display: flex; justify-content: space-around;"> <div style="text-align: center;">  Alu 0 307 98                 </div> <div style="text-align: center;">  White 0 307 95                 </div> </div>	<p><b>Dimmable lighting module</b> Enables the user to set the lighting level on his workstation via a 45 mm Mosaic dimmer</p>
1	<div style="display: flex; justify-content: space-around;"> <div style="text-align: center;">  Alu 0 307 99                 </div> <div style="text-align: center;">  White 0 307 96                 </div> </div>	<p><b>Light and presence sensor lighting module</b> Equipped with a sensor, the module detects the user's presence and automatically adjusts the needed light level depending on natural light level</p>

## Mini columns, movable columns and supports



- For distribution of power vertically with the input in separate ducts for high voltage and low voltage cables
- Power supply via the ceiling and/or the floor
- To be equipped with supports for wiring accessories

Pack	Cat.Nos	Mini-column
1	<div style="display: flex; justify-content: space-around;"> <div style="text-align: center;">  Alu 0 307 29                 </div> <div style="text-align: center;">  White 0 307 42                 </div> </div>	<p>Consisting of:</p> <ul style="list-style-type: none"> <li>- 4-compartment aluminium body</li> <li>- Fixing base with protective cap</li> <li>- 4 anodised aluminium or white PVC covers</li> <li>- Finishing cap</li> </ul> <p>Height 68 cm</p>
1	<div style="text-align: center;">  White 0 307 00                 </div>	<p><b>Movable column</b></p> <p>Comprising:</p> <ul style="list-style-type: none"> <li>- An aluminium base, length 2 m, 4 compartments</li> <li>- A Ø60 mm flexible sheath, capacity 4 x Ø20, length 2 m</li> <li>- 1 foot, 12 kg, size Ø400 mm</li> <li>- 4 white PVC covers</li> </ul> <p>Power supply from ceiling via a flexible sheath Radius of movement of the column in relation to power supply point: 1.5 m Fixing in false ceiling which must not be more than 3 m high Height 2.00 m</p>
1	<div style="display: flex; justify-content: space-around;"> <div style="text-align: center;">  Alu 0 307 78                 </div> <div style="text-align: center;">  White 0 310 65                 </div> </div>	<p><b>Supports for columns</b></p> <p>To be equipped with Mosaic or Arteor sockets</p> <p>4 modules - Length 215 mm 8 modules - Length 325 mm 12 modules - Length 415 mm</p>
1	<div style="display: flex; justify-content: space-around;"> <div style="text-align: center;">  Alu 0 307 79                 </div> <div style="text-align: center;">  White 0 310 66                 </div> </div>	
1	<div style="display: flex; justify-content: space-around;"> <div style="text-align: center;">  Alu 0 307 80                 </div> <div style="text-align: center;">  White 0 310 67                 </div> </div>	



# Columns and half-columns

aluminium and white finishes

## Columns and half-columns Cat.Nos 0 307 03/07/08/09/27/28

The system of full aluminium columns offers:

- The cable management
- The use of various types of mounting boxes
- An internal structure of aluminium with aluminium lids, protection accessories for columns and completion accessories
- Until 4 equipped (mounting boxes)
- Separation of data and energy cables
- Energy supply by the ground or the overhead
- Height 2.70 m/3.90 m (680 mm for mini-columns) can be adapted to a ceiling height 3.80 m/5 m

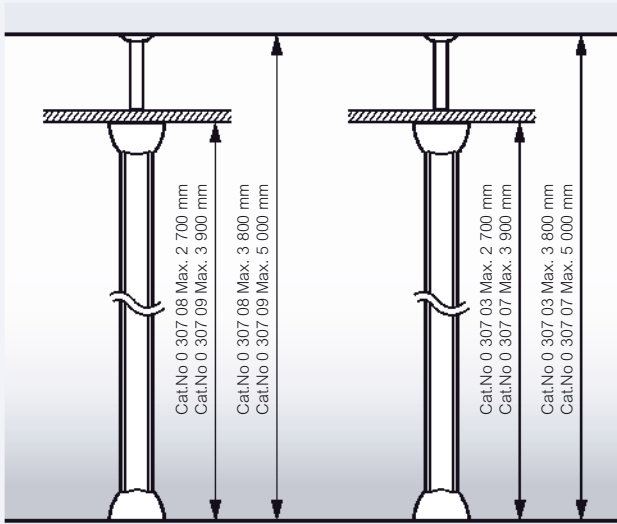
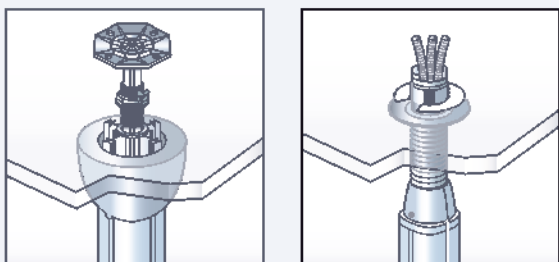

### Space available for cable management

	Body		Body & mounting box	
	Ø Maxi	Section (mm <sup>2</sup> )	Ø Maxi	Section (mm <sup>2</sup> )
<b>Columns</b> 0 307 03/07/08/09 	25	1250	2 x 13	350
<b>Half-columns</b> 0 307 27/28 	28	1200	13	200

### Dimensions

Protection covers for columns:

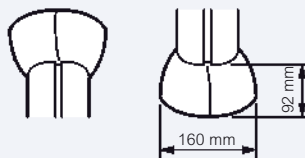

Half-protection covers for half-columns:



Base plate of fixing for columns:

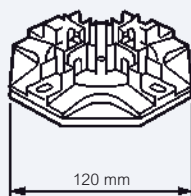

Base plate of fixing for half-columns:

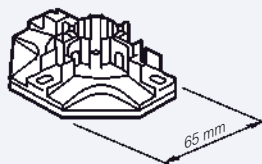

Aluminium body + PVC covers for columns:

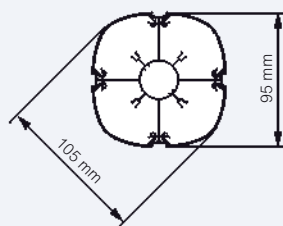

Aluminium body + PVC covers for half-columns:

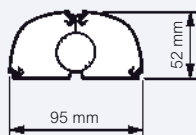

# Over floor trunking



0 300 92



0 300 93



0 328 00



Conform to standard EN 50085-2-2

For creating a link between trunking, column, mini-column, floor units or protecting cables on passageways

Supplied with cover

## Over floor trunking 50 x 12 mm

Pack	Cat.Nos	Description
54 <sup>1</sup>	0 300 92	Length 2 m, supplied with cover 3 compartments Capacity 1: max. Ø9 mm Capacity 2: max. Ø6 mm RAL 7030

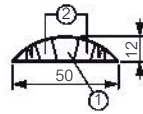

### Accessories

10	0 300 12	Cover joint
10	0 300 11	Flat angle

## Over floor trunking 75 x 18 mm

Pack	Cat.Nos	Description
36 <sup>1</sup>	0 300 93	Length 2 m, supplied with cover 3 compartments Capacity 1: max. Ø14 mm Capacity 2: max. Ø11 mm RAL 7030

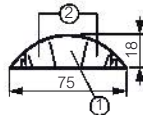

### Accessories

10	0 300 19	Cover joint
10	0 300 18	Flat angle

## Over floor trunking 92 x 20 mm

Pack	Cat.Nos	Description
20 <sup>1</sup>	0 328 00	Length 2 m, supplied with cover 4 compartments Equipped with 2 adhesive strips for better floor fixing Capacity 1: max. Ø14.5 mm Capacity 2: max. Ø9.5 mm RAL 7016

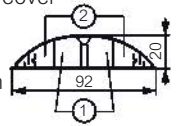

### Accessories

10	0 328 07	End cap
10	0 328 03	Cover joint
5	0 328 02	Flat angle
1	0 328 05	Junction to floor duct

### Junction between floor duct and trunkings

5	0 107 71 + 0 106 90	To be used with Cat.No 0 328 00 For cover 65 mm
5	0 107 72 + 0 106 90	For cover 85 mm



1: Number of metres in pack

## Surface-mounting floor units, floor service outlet boxes, access units



Technical characteristics [see e-catalogue](#)

Pack	Cat.Nos	Surface-mounting floor sockets to be equipped
5	0 317 48	<p>Empty electrical wiring accessories to be equipped with Mosaic screw connection sockets Equipped with pivoting wiring supports for easy installation of sockets Can be combined with over floor trunking Cat.No 0 328 00 Can be illuminated with LED Cat.No 0 899 06</p> <p>2 x 4 modules 3 x 4 modules LED to be wired, 230 V High luminescence orange neon</p>
5	0 317 49	
10	0 899 06	
<p><b>Floor service outlet boxes - 3 modules</b></p> <p>Access units for raised or concrete floor (minimum height 80 mm) To be equipped with: 1 Mosaic socket outlet 2P+E 2 modules and 1 Mosaic RJ 45 - 1 module or 1 Arteor socket outlet 2P+E and 1 Arteor RJ 45 1 module Grey RAL 7031</p>		
1	0 896 44	Floor service outlet box - 3 modules
1	0 896 49	Flush-mounting box for concrete for Cat.No 0 896 44
<p><b>Small aluminium access grommet</b></p> <p>Body - cast aluminium Main jaw - injection moulded plastic Nylon 66 Inner jaws - closed cell Neoprene Recommended hole cut-out size: 127 mm diameter Will fit floor tile thickness range of 25 to 55 mm Can form the base of a cable management products such as power posts and poles Standard depth: 60 mm Access grommet IP 20 - IK 08</p>		
1	0 893 07	
<p><b>Access units</b></p> <p>Access units for raised or concrete floor (minimum height 90 mm) Supplied with stainless steel cover or cover for carpet Grey RAL 7031</p>		
<p><b>Small dimensions</b></p>		
1	0 896 90	With cover for carpet
1	0 896 91	With stainless steel cover
<p><b>Large dimensions</b></p>		
1	0 896 94	With cover for carpet
1	0 896 95	With stainless steel cover

## Metal and plastic backboxes for concrete floor

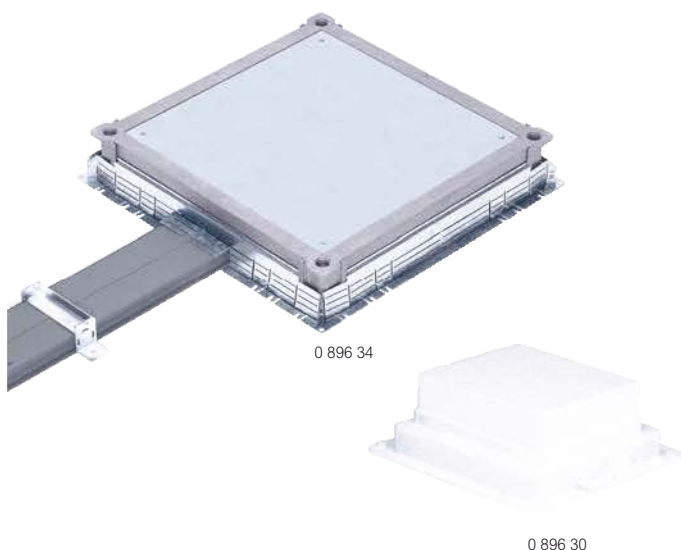

Technical characteristics [see e-catalogue](#)

Pack	Cat.Nos	Adjustable metal backbox for concrete floor
<p><b>Universal backbox</b></p> <p>For junction of LV and ELV cabling and/or installation of floor boxes Height adjustable from 56 mm to 140 mm using 4 screws located in the box corners and a tool adapting to electric drill or screwdriver Bendable side walls for joining with different sizes of floor ducts Supplied with worksite protection cover to be replaced by blanking cover plate or mounting cover plate</p>		
1	0 896 34	Universal metal in-screed backbox
<p><b>Cover plates</b></p> <p>Thickness 3 mm</p>		
5	0 896 35	Blanking cover plates for simple junction
5	0 896 36	Adaptor plate for floor boxes 12 modules, or floor boxes of reduced height 10 modules
5	0 896 37	Adaptor plate for floor boxes 18 modules
5	0 896 38	Adaptor plate for floor boxes 24 modules, or floor boxes of reduced height 16 modules
<p><b>Auto-adjustable plastic backboxes for concrete floor</b></p> <p>For integration of floor boxes in in-screed floor installations Power supply by flexible conduits Ø16, 20 and 25 mm Supplied with polystyrene for easy installation</p>		
1	0 896 30	For 12 modules floor boxes or 10 modules reduced height floor boxes
1	0 896 31	For 18 modules floor boxes
1	0 896 32	For 24 modules floor boxes or 16 modules reduced height floor boxes
<p><b>Backboxes for shallow concrete floor and insulation boxes for raised floor</b></p> <p>For integration of 50 mm "reduced height" floor boxes Cat.No 0 880 70 (see opposite) in raised or screed floor installations Power supply by flexible conduits Ø16, 20 and 25 mm or floor trunking 28 mm height Backbox for shallow concrete floor Insulation box for raised floors</p>		
1	0 880 73	
1	0 880 71	

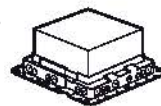

PVC floor duct, please consult us

## Adjustable height floor boxes to be equipped

## Reduced height floor boxes to be equipped



0 896 05



0 896 11 equipped with Mosaic sockets

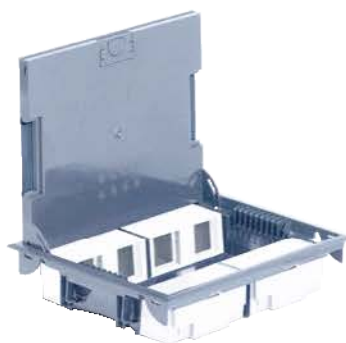

0 896 26



Technical characteristics **see e-catalogue**

Pack	Cat.Nos	75-105 mm adjustable height floor boxes
		For raised or screed floor between 75 and 105 mm Conform to standard EN 60-670 and EN 50085-2-2 Workstation connection for raised or concrete floor, using plastic or metal backbox (see opposite) Supplied with reversible stainless steel cover or cover for carpet Horizontal wiring device positioning: - height adjustable from 75 to 105 mm - ensure perfect cable separation - takes 2 flexible conduits Ø20 mm - shifted from one another for optimal connection for all sockets - take marking labels Easy opening cover with rings and holding in open position during connection To be equipped with Mosaic or Arteor wiring accessories
		<b>12 modules</b>
1	0 896 05	With stainless steel cover Grey RAL 7031
1	0 896 06	With cover for carpet Grey RAL 7031
1	0 896 07	With cover for carpet Beige RAL 1019
		<b>18 modules</b>
1	0 896 10	With stainless steel cover Grey RAL 7031
1	0 896 11	With cover for carpet Grey RAL 7031
1	0 896 12	With cover for carpet Beige RAL 1019
		<b>24 modules</b>
1	0 896 15	With stainless steel cover Grey RAL 7031
1	0 896 16	With cover for carpet Grey RAL 7031
1	0 896 17	With cover for carpet Beige RAL 1019



Pack	Cat.Nos	65 mm "reduced height" floor boxes
		For raised or screed floor $\geq$ 65 mm Conform to standard EN 60-670 and EN 50085-2-2 Workstation connection for raised or concrete floor, using plastic or metal backbox (see opposite) Supplied with reversible stainless steel cover or cover for carpet or parquet Vertical wiring device positioning: - supplied with blanking plates requiring sufficient space between the sockets if angled plugs are used - takes marking labels - ensures perfect cable separation Easy opening cover by rings and holding in open position during connection To be equipped with Mosaic or Arteor wiring accessories
		<b>10 modules</b>
		For installing 4 x 2 modules Mosaic and 2 x 1 module Mosaic
1	0 896 20	With stainless steel cover, grey RAL 7031
1	0 896 21	With cover for carpet, grey RAL 7031
1	0 896 22	With cover for carpet, beige RAL 1019
		<b>16 modules</b>
		For installing 8 x 2 modules Mosaic
1	0 896 25	With stainless steel cover, grey RAL 7031
1	0 896 26	With cover for carpet, grey RAL 7031
1	0 896 27	With cover for carpet, beige RAL 1019
		<b>N 50 mm "reduced height" floor boxes</b>
		<b>16 modules</b>
1	0 880 70	For raised or screed floor between 50 and 70 mm Workstation connection for raised or concrete floors To be used with backbox Cat.No 0 880 73 (in concrete floors) or with insulation box Cat.No 0 880 71 (in raised floors) (p. 772) Supplied with cover for carpet Vertical wiring device positioning Ensures perfect cable separation Easy opening cover by handle To be equipped with Mosaic or Arteor wiring accessories With cover for carpet, grey RAL 7031 Can be equipped with stainless steel finishing plate Cat.No 0 880 72
		<b>Stainless steel finishing plate</b>
1	0 880 72	For 50 mm reduced height floor box Cat.No 0 880 70



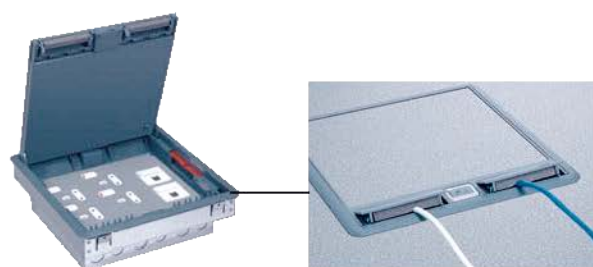

6 896 30 equipped with British Standard sockets and wiring devices (p. 369 to 378)



Rigid cable exits



6 896 31 equipped with British Standard sockets and wiring devices (p. 369 to 378)



Flexible cable exits



6 896 39



6 896 60



6 896 34



6 896 73



6 896 78

Technical characteristics **see e-catalogue**

Conform to IEC 60670-23 and to BS EN 50 085-2.2  
Compatible with either raised access floor trunking system and screed floor system

Pack	Cat.Nos	Lid and trims for carpet
		To be equipped with Arteor wiring accessories Supplied with flexible or rigid cable exits
		<b>3-compartment floor boxes</b> To be filled on either - modular backbox for raised floors Cat.No 6 896 39 - screed floor backbox Cat.No 6 896 34
5	6 896 30	Grey cover RAL 7031 with rigid cable exits
5	6 896 31	Grey cover RAL 7031 with flexible cable exits
		<b>4-compartment floor boxes</b> To be filled on either - modular backbox for raised floors Cat.No 6 896 49 - screed floor backbox Cat.No 6 896 45
5	6 896 40	Grey cover RAL 1019 with rigid cable exits
5	6 896 41	Grey cover RAL 1019 with flexible cable exits
		<b>Modular backbox for raised floors</b> Adjustable height between 86 to 107 mm To be fitted with lid and trims for carpet and support plates for Arteor Wiring accessories (p. 385) Backboxes are connected to the raised floor trunking system with flexible conduits One complete assembly consists of: support frame + modules + lid and trim
		<b>Support frame</b> To be equipped with modules below
1	6 896 39	3 compartments (264 x 264 mm)
1	6 896 49	4 compartments (264 x 341 mm)
		<b>Module</b>
4	6 896 60	Single module for 77 mm plates

Pack	Cat.Nos	Screed floor backboxes
		To be fitted with lid and trim for carpet and support plates for Arteor mechanisms Accept PVC and metal screed floor ducting and conduits Ø20 mm and Ø25 mm Auto-adjustable to screed height 65 up to 90 mm
		<b>For ducting up to 225 mm</b>
1	6 896 34	3 compartments
		<b>For ducting up to 300 mm</b>
1	6 896 45	4 compartments
		<b>Support plates for Arteor mechanism</b> Support plates for integration of Arteor mechanisms in floor boxes 77 mm width plate
		<b>Flat support plates</b>
12	6 896 73	For 4 modules (2 x 2 modules)
12	6 896 74	For 6 modules (3 x 2 modules)
12	6 896 77	For 6 modules (2 x 3 modules)
		<b>Waved support plates</b>
4	6 896 78	For 4 modules (2 x 2 modules)



## Floor boxes for tiles/marble



## Steel & polycarbonate floor box



6 896 56 + 0 896 04

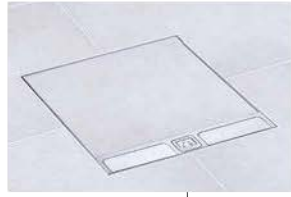

6 896 51 + 0 896 04



6 896 56 equipped with Arteor mechanisms (p. 369 to 378)



6 896 51 equipped with Arteor mechanisms (p. 369 to 378)



CFB3EC

Technical characteristics **see e-catalogue**

Conforms to IEC 60670-23 and to BS EN 50 085-2.2  
Compatible with screed floor system

Pack	Cat.Nos	Lid and trim for tiles/marble
1	6 896 56	To be installed in backbox Cat.No 0 896 04 for screed floor system To be equipped with support plates for Arteor mechanisms (p. 385) <b>Single cable outlet stainless steel lid and trim</b> Edge trim for tile 8 to 15 mm thickness
1	6 896 55	<b>Single cable outlet powder coated lid and trim</b> Edge trim for tile 8 to 15 mm thickness Grey RAL 7031
1	6 896 51	<b>Double cable outlet stainless steel lid and trim</b> Edge trim for tile 8 to 15 mm thickness
1	6 896 52	<b>Double cable outlet powder coated lid and trim</b> Edge trim for tile 15 to 12 mm thickness
1	0 896 04	<b>Specific backbox</b> For installation of floor boxes Cat.Nos 6 896 51/52/55/56 for screed floor system

Pack	Cat.Nos	3-compartment floor box for South Africa
1	CFB3EC	<b>Floor box</b> Recommended hole cut out size: 305 x 225 mm Standard depth: 75 mm Universal knockouts (20/25 mm) to each compartment Manufactured from pre-galvanised steel and polycarbonate/ABS Supplied with back box
1	CFB6MOD	<b>Support plate for Arteor mechanism</b> For 6 modules
1	CFBBLANK	<b>Blank plate</b> For unused space

## Heavy duty in-screed floor box

for concrete floors



0 896 34 + 0 896 83 + 0 896 85



0 896 34 + 0 896 83 + 0 896 86 + 0 896 87



0 896 34 + 0 896 83 + 0 896 88

For highly frequented areas, requiring important mechanical resistance and/or washing down  
Conform to standard EN 60-670 and EN 50 085-2-2

Pack	Cat.Nos	Metal in-screed floor box	
1	0 896 34	Universal metal in-screed backbox Junction or connection point for concrete floor according to type of cover associated For junction of LV and ELV cabling and/or installation of floor boxes Height adjustable from 105 mm to 140 mm using 4 inserts located in the box corners and a tool adapting to electric drill or screwdriver Bendable side walls for assembling with different sizes of floor ducts Supplied with worksite protection cover to be replaced by blanking cover plate or mounting cover plate Allowing floor covering infill between 6 and 24 mm	
1	0 896 83	<b>Accessories for metal in-screed floor box</b> Normal load support Up to 8 KN load with deflection < 6 mm	
1	0 896 84	Heavy load support Up to 20 KN load with deflection < 3 mm	
6	0 896 39	Set of 2 conduit adaptors for metal cavity floor box Cat.No 0 896 34	
<b>Plates for metal in-screed floor boxes</b>			
For metal in-screed floor box Cat.No 0 896 34 Use support Cat.No 0 896 83 or 0 896 84			
1	0 896 85	<b>All types of floors</b> IP 66 plain cover (cover closed) Access trap for junction, no cable exit	
1	0 896 86	<b>Marbled and tiled floors</b> IP 66 plate (cover closed and plugs not connected) with central cable exit To receive 24 mosaic modules Supplied with all necessary wiring accessories supports	
1	0 896 87	<b>Accessory for plate with central cable exit</b> Cable exit accessory for IP 66 cover plate Cat.No 0 896 86	
1	0 896 88	<b>Wooden floors</b> IP 30 plate with 2 lateral cable exits To receive 24 mosaic modules Supplied with all necessary wiring accessories supports	

## Heavy duty in-screed floor box

### Metal in-screed floor box, installation principle

When used as junction box

Junction box with plain cover Cat.No 0 896 85

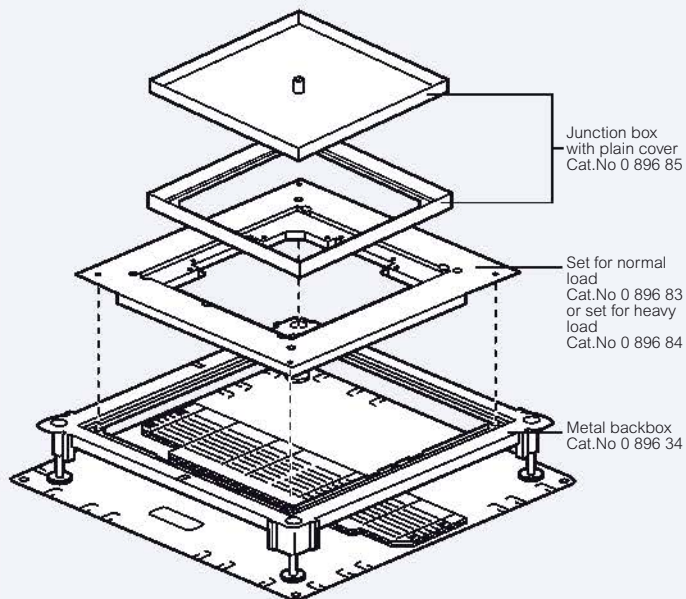

When used as floor box for wiring accessories

Floor box with central cable Cat.No 0 896 86

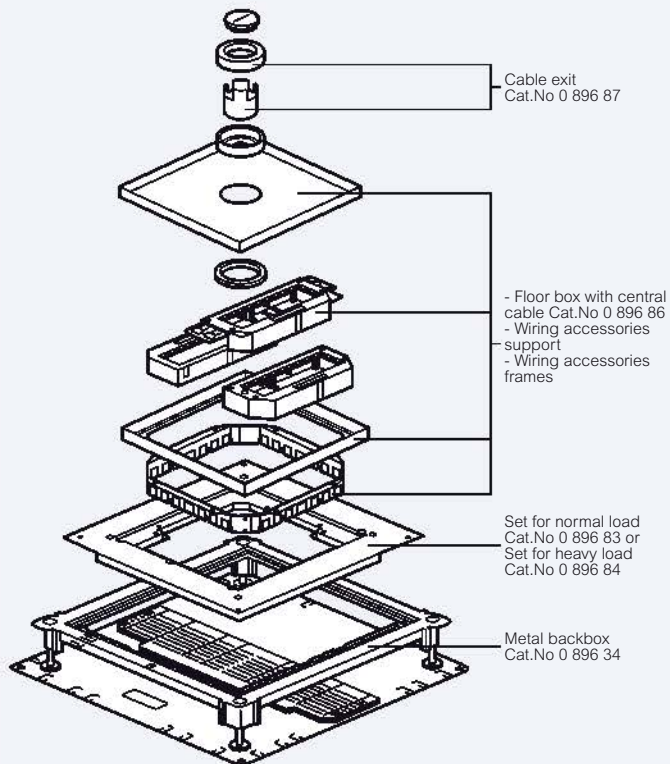

# Pop-up type flush-mounting boxes

for workstation & meeting room table applications

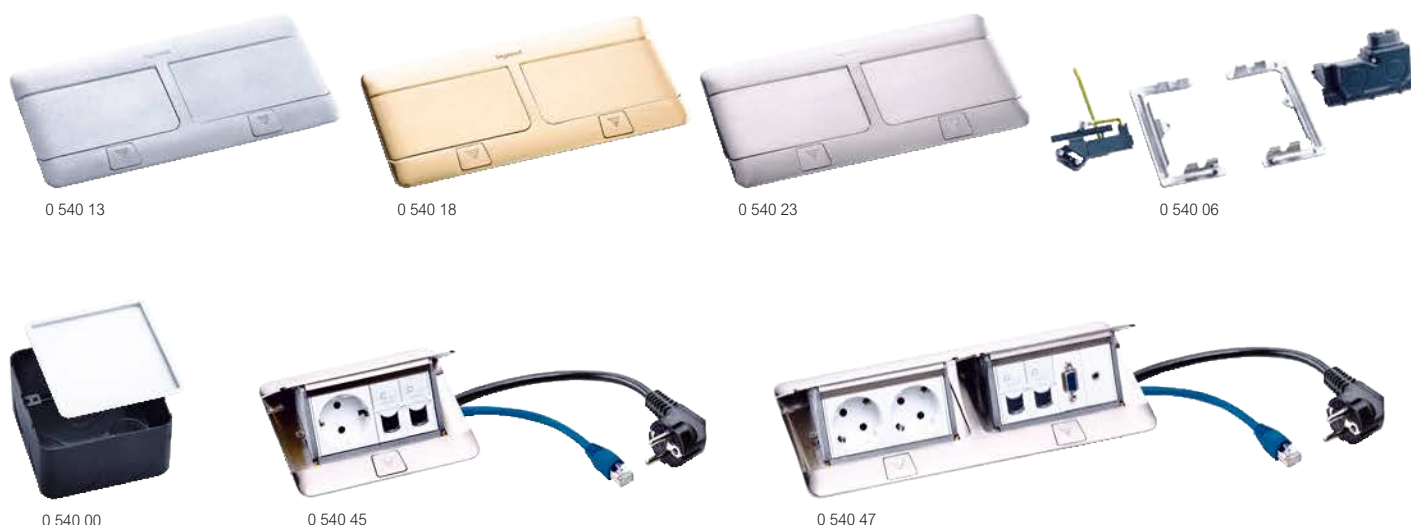

Technical characteristics p. 778

Can be installed in concrete or raised access floors or integrated directly into the furniture (desks, meeting room tables, etc)  
Conform to IEC 60670-1, IEC 60670-23 et IEC 60884-1

Pack	Cat.Nos	Pop-up boxes to be equipped	Pack	Cat.Nos	Flush-mounting boxes for installation in concrete floors
1	0 540 10	<p>Slim design for perfect integration into the floor or office furniture Soft opening for enhanced comfort and safety Equipped with "push and slide" locking system to avoid accidental opening by feet To be equipped with Mosaic or Arteur socket outlets For installation use the flush-mounting boxes for concrete floors or the kits for raised access floors or table top (see below)</p> <p><b>3 modules</b></p> <ul style="list-style-type: none"> <li>● Matt Aluminium finish</li> <li>● Brushed Brass</li> <li>● Brushed Stainless Steel finish</li> </ul> <p><b>6 (2 x 3) modules</b></p> <ul style="list-style-type: none"> <li>● Matt Aluminium finish</li> <li>● Brushed Brass</li> <li>● Brushed Stainless Steel finish</li> </ul> <p><b>4 modules</b></p> <ul style="list-style-type: none"> <li>● Matt Aluminium finish</li> <li>● Brushed Brass</li> <li>● Brushed Stainless Steel finish</li> <li>● Matt Black</li> <li>● Glossy White</li> </ul> <p><b>8 (2 x 4) modules</b></p> <ul style="list-style-type: none"> <li>● Matt Aluminium finish</li> <li>● Brushed Brass</li> <li>● Brushed Stainless Steel finish</li> <li>● Matt Black</li> <li>● Glossy White</li> </ul>	1	0 540 00	<p>For installation of pop-up floor boxes in concrete floors Equipped with knockouts for <math>\Phi</math> 20 and <math>\Phi</math> 25 mm conduits</p> <p><b>Metal flush-mounting boxes</b></p> <ul style="list-style-type: none"> <li>3 modules</li> <li>6 (2 x 3) modules</li> <li>4 modules</li> <li>8 (2 x 4) modules</li> </ul> <p><b>Plastic flush-mounting boxes</b></p> <ul style="list-style-type: none"> <li>3 modules</li> <li>6 modules</li> </ul>
1	0 540 15		1	0 540 02	
1	0 540 20		1	0 540 01	
1	0 540 23	1	0 540 03		
1	0 540 12	<p><b>Retractable kits</b></p> <p>Composition:</p> <ul style="list-style-type: none"> <li>- retractable cord</li> <li>- Mosaic cover plate</li> <li>- fixing accessory</li> </ul>	1	6 503 90	<p>RJ 45 cat. 6 UTP retractable kit. 1 module</p>
1	0 540 17		1	6 503 31	
1	0 540 22		1	0 540 34	<p>Equipped pop-up boxes</p> <p>Slim design for perfect integration into the floor or office furniture Soft opening for enhanced comfort and safety Equipped with "push and slide" locking system to avoid accidental opening by feet Supplied with installation kits for raised access floors or table top</p> <p><b>With power &amp; data sockets - 4 modules</b></p> <p>Pre-wired and equipped with:</p> <ul style="list-style-type: none"> <li>- 1 x 2P+E socket - German standard</li> <li>- 2 x RJ 45 data sockets Cat. 6 UTP</li> <li>- 2 m cord with 2P+E plug</li> <li>- 3 m RJ 45 cord with RJ 45 Cat. 6 UTP plug</li> </ul>
1	0 540 11	<p><b>Installation kits for raised access floors or table top</b></p> <p>Include an empty receptacle and fixing brackets for raised access floor tiles or table tops Equipped with cable retainer for power cables, to ensure increased safety of the installation Compatible with:</p> <ul style="list-style-type: none"> <li>- Cat. 6 data cabling</li> <li>- audio/video cabling</li> </ul>	1	0 540 44	<p>● Glossy White</p>
1	0 540 16		1	0 540 45	
1	0 540 21		1	0 540 46	<p><b>With power, data &amp; audio-video sockets 8 (2 x 4) modules</b></p> <p>Pre-wired and equipped with</p> <ul style="list-style-type: none"> <li>- 2 x 2P+E socket - German standard</li> <li>- 2 x RJ 45 data sockets Cat. 6 UTP</li> <li>- 1 HD 15 connector + 3.5 mm jack</li> <li>- 2 m cord with 2P+E plug</li> <li>- 3 m RJ 45 cord with RJ 45 Cat. 6 UTP plug</li> <li>- 0.1 m female VGA cord</li> <li>- 0.1 m female jack 3.5 mm cord</li> </ul>
1	0 540 26	<p><b>Equipped pop-up boxes</b></p> <p>Slim design for perfect integration into the floor or office furniture Soft opening for enhanced comfort and safety Equipped with "push and slide" locking system to avoid accidental opening by feet Supplied with installation kits for raised access floors or table top</p> <p><b>With power &amp; data sockets - 4 modules</b></p> <p>Pre-wired and equipped with:</p> <ul style="list-style-type: none"> <li>- 1 x 2P+E socket - German standard</li> <li>- 2 x RJ 45 data sockets Cat. 6 UTP</li> <li>- 2 m cord with 2P+E plug</li> <li>- 3 m RJ 45 cord with RJ 45 Cat. 6 UTP plug</li> </ul>	1	0 540 47	<p>● Glossy White</p>
1	0 540 31		1	0 540 47	<p>● Brushed Stainless Steel finish</p>
1	0 540 13		1	0 540 47	<p>● Brushed Stainless Steel finish</p>

# Pop-up type flush-mounting boxes

## technical characteristics

### Technical characteristics

Classification of pop-up flush-mounting boxes according to NFC 61-314 / EN 60670-1 / EN 60670-23

Earthing system:  $R < 0.05 \text{ Ohms}$   
 Protection against mechanical impact: IK 07  
 Degree of protection: IP 30 cover open  
 IP 40 cover closed  
 Resistance to vertical load applied through small surface area:  
 1500 N cover open  
 3000 N cover closed  
 Rated voltage: U 500 V -  $R > 5 \text{ MOhms}$   
 Electric strength: 2000 V  
 Installation on the floor: to be installed on floor subjected to a dry treatment

### Material

Halogen free, fire proofed and no propagator of the flame  
 Corrosion resistant and to temperature changes

Finishes	Material
Brass	Brass material
Aluminium	Aluminium material
Stainless Steel	Zamak nickel coating
Black	Aluminium material with black painting
White	Aluminium material with white painting

### High/low current compatibility

Floor type	High current	Low current
Concrete	Yes	No
Technical floor	Yes	Cat. 6 compatible
Furniture	Yes	Cat. 6 compatible

### Installation

#### Desk or technical floor

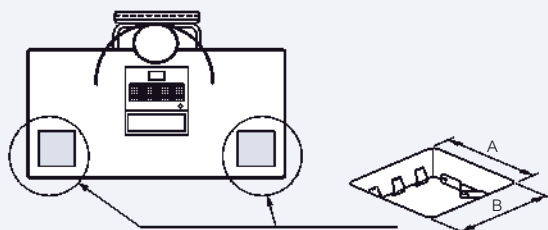

Pop-up size	A <sup>(1)</sup> (mm)	B <sup>(1)</sup> (mm)
3 modules	108	108
4 modules	108	131
6 modules	108	218
8 modules	108	263

1: +/- 1 mm

#### Concrete floors (fixing centres)

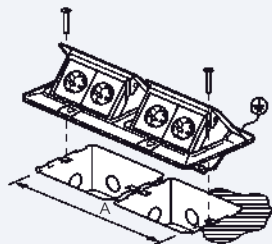

Pop-up size	A (mm)
3 modules	84
4 modules	106.5
6 modules	194
8 modules	239

### Dimensions

#### Cover

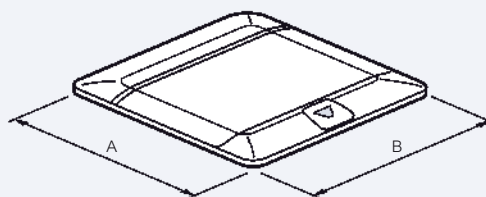

Pop-up size	A (mm)	B (mm)
3 modules	120	120
4 modules	120	142.5
6 modules	120	230
8 modules	120	275

#### Empty pop-up

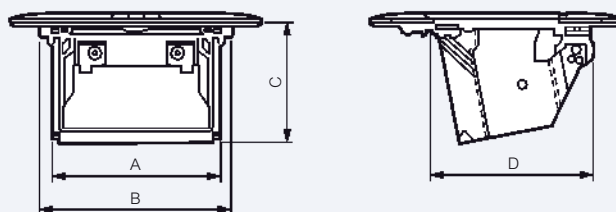

Pop-up size	A (mm)	B (mm)	C (mm)	D (mm)
3 modules	79.8	92	57	77.5
4 modules	102.3	114.5	57	77.5
6 modules	189.8	202	57	77.5
8 modules	231.6	247	57	77.5

#### Pop-up with installation kit for desk or technical floor

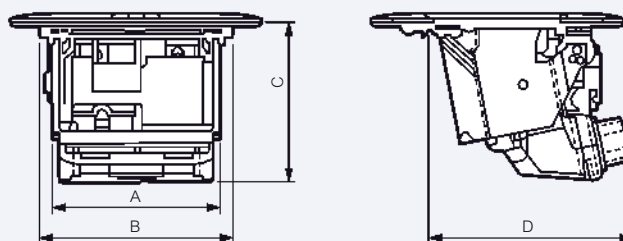

Pop-up size	A (mm)	B (mm)	C (mm)	D (mm)
3 modules	79.8	92	74.8	96.1
4 modules	102.3	114.5	74.8	96.1
6 modules	189.8	202	74.8	96.1
8 modules	231.6	247	74.8	96.1

# Power & data desk grommets

for workstation & meeting room table application



Technical characteristics [see e-catalogue](#)

Particularly suitable for integration of power, mobile phone charger and data connections into desks  
Conform to IEC 60884-1

Pack	Cat.Nos	Equipped power & data desk grommets	Pack	Cat.Nos	Empty power & data desk grommets
1	German standard 0 540 80	British standard 0 540 90	1	0 540 70	<p>To be equipped with Mosaic or Arteor socket outlets, pre-wired modules with retractable cords and finishing plates (see e-catalogue) Easily retro fitted into a 60 to 80 mm diameter hole in current office desks and workspace table tops (by replacing the desk grommet) Cover opens to 180° angle to prevent breaking</p> <p><b>For one 2P+E socket</b> ○ White RAL 9003 ● Black RAL 9017</p> <p><b>For one 2P+E socket and USB phone charger</b> Supplied with one USB phone charger output 5 V<sub>~</sub> 750 mA, to be wired ○ White RAL 9003 ● Black RAL 9017</p> <p><b>Finishing plates for empty power &amp; data desk grommets</b> For fitting on an empty power &amp; data desk grommets ○ White RAL 9003 ● Black RAL 9017 ● Stainless Steel ○ White RAL 9003 for Cat. 6A data networks</p> <p><b>Pre-wired modules with retractable cord</b> For fitting on power &amp; data desktop modules (under the table top) Automatic cable rewind when not connected, for an optimized use of the desk surface</p> <p><b>Cat. 6 FTP</b> Equipped with: - 1.35 m RJ 45 Cat. 6 FTP retractable cord on the user side and - 1 x RJ 45 socket on the installation side Patch cord for connection to data network to be ordered separately (p. 673)</p> <p><b>Cat. 6 UTP</b> Equipped with: - 1.35 m RJ 45 Cat. 6 UTP retractable cord on the user side and - RJ 45 socket on the installation side Patch cord for connection to data network to be ordered separately (p. 673)</p> <p><b>USB / micro USB</b> Equipped with: - 1.35 m retractable cord with micro USB connector, on the user side and - 0.5 m cable with USB connector on the installation side</p>
1	0 540 81	0 540 91	1	0 540 71	
1	0 540 82	0 540 92	1	0 540 72	
1	0 540 85	0 540 95	1	0 540 73	
1	0 540 86	0 540 96	10	0 540 60	
1	0 540 87	0 540 97	10	0 540 62	
1	0 540 88	0 540 98	10	0 540 63	
1	0 540 88	0 540 98	10	0 540 61	
1	0 540 75	Drill	1	0 540 65	
		For cutting holes of 80 mm diameter	1	0 540 66	
			1	0 540 67	

## Desktop multi-outlet extensions



6 535 50



6 535 53



6 535 30

Aluminium extensions with reversible cable guide for grouping cords of connected devices  
 For low current sockets, connection on RJ 45 sockets or area distribution box with specific cord RJ 45/stripped Cat.Nos 0 517 96/97/98 (see p. 676)  
 2P+E sockets with 45° sloping screw recesses for easy insertion of angled plug  
 16 A - 250 V - with shutters  
 3680 W at 230 V per circuit  
 Conform to IEC 60-884-1

Pack	Cat.Nos	With high-current sockets
1	6 535 50	Supplied without cord High current connection on terminal blocks with cable grip - 6 x 2P+E sockets
1	6 535 51	- 1 illuminated switch - 2 x 2P+E sockets - 2 x 2P+E tamperproof sockets
1	6 535 52	<b>With high-current and low-current sockets</b> Supplied without cord High current connection on terminal blocks with cable grip - 4 x 2P+E sockets
1	6 535 53	- 3 x RJ 45 sockets Cat. 6 UTP 1 module - 2 x 2P+E sockets - 2 x 2P+E tamperproof sockets - 2 x RJ 45 sockets Cat. 6 UTP - 2 blanking plates 1 module for VDI
1	6 535 30	<b>With high-current sockets, USB phone charger and data connection</b> - 2 x 2P+E sockets - 1 x USB phone charger - 0.9 m RJ 45 Cat. 6 FTP retractable cord
1	6 535 31	- 3 m power cord with 2P+E plug - 2 x 2P+E sockets - 1 x USB phone charger - 2 x RJ 45 sockets Cat. 6 UTP - 3 m power cord with 2P+E plug

## Desktop multi-outlet extensions to be equipped



0 535 90



0 535 91



0 535 99



0 535 98

Pack	Cat.Nos	Empty aluminium extensions
1	0 535 90	Aluminium extensions with cable guide (reversible) To be equipped with Mosaic sockets
1	0 535 91	8 modules
1	0 535 92	12 modules
1	0 535 92	16 modules
5	0 535 99	<b>Accessories</b> <b>Fixing accessory</b> Fixing accessory to clip on desktop
		<b>Cable worm</b>

## Meeting room multi-outlet extensions with cord



6 535 75



6 535 77



6 535 70



6 535 72

Pack	Cat.Nos	For meeting rooms with central table
1	6 535 74	<p>Equipped with 8 x 2P+E sockets with 45° sloping screw recesses for easy insertion of angled plug On/off switch with light indicator 3680 W at 230 V~ Equipped with 5 m cord (H05VVF 3G 1,5 mm<sup>2</sup>) with 2P+E plug Supplied with carrying case</p> <p><b>High current</b> For connecting up to 8 devices Composition: - 8 x 2P+E with 45° sloping screw recesses</p>
1	6 535 75	<p><b>With non manageable switch</b> For connecting up to 8 devices and networking up to 6 peripherals (computers...) Requires the use of Ethernet 10/100 base T network cards on the peripherals for 10/100 Mbps data exchanges Composition: - 8 x 2P+E sockets - 1 10/100 base T non manageable switch 6 ports Network cable not supplied</p>
1	6 535 77	<p><b>With non manageable switch and HD 15 + jack socket</b> For connecting up to 7 devices and networking up to 6 peripherals (computers...) One connection point with HD 15 connector and a 3.5 mm jack Requires the use of Ethernet 10/100 base T network cards on the peripherals for 10/100 Mbps data exchanges Composition: - 7 x 2P+E sockets - 1 10/100 base T non manageable switch with 6 ports - 1 HD 15 socket + 3.5 mm jack - 1 female VGA cord, length 1 m. To be used with a VGA extension - 1 female jack 3.5 mm cord, length 1 m Network cable not supplied</p>

Pack	Cat.Nos	For meeting rooms with U table
1	6 535 70	<p>Aluminium extensions 2P+E sockets with 45° sloping screw recesses for easy insertion of angled plug 16 A - 250 V~ with shutters 3680 W at 230 V~ per circuit Equipped with 3 m cord (H05VVF, 3G 1,5 mm<sup>2</sup>) with 2P+E plug and 3 m cord with RJ 45 Cat.6 FTP plug, wired</p> <p><b>With switch</b> For connecting up to 6 devices and networking up to 6 peripherals (computers...) Requires the use of Ethernet 10/100 base T network cards on the peripherals for 10/100 Mbps data exchanges Voltage power indicator on front panel Composition: - 6 x 2P+E sockets - 1 non manageable 10/100 base T switch 6 ports</p>
1	6 535 72	<p><b>With non manageable switch and HD 15 + jack socket</b> For connecting up to 5 devices and networking up to 6 peripherals (computers...) One connection point with HD 15 connector and a 3.5 mm jack Requires the use of Ethernet 10/100 base T network cards on the peripherals for 10/100 Mbps data exchanges Composition: - 5 x 2P+E sockets - 1 10/100 base T non manageable switch with 6 ports - 1 HD 15 socket + 3.5 mm jack - 1 female VGA cord, length 1 m. To be used with a VGA extension - 1 female jack 3.5 mm cord, length 1 m</p>



# MOSAIC

## WIRING ACCESSORIES & HEALTHCARE BUILDINGS

### Mosaic™ Programme



**P. 784**  
Switches,  
pushbuttons,  
ventilation control

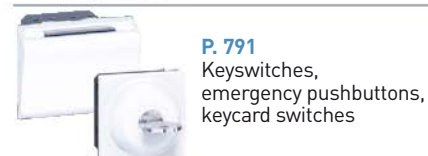

**P. 791**  
Keyswitches,  
emergency pushbuttons,  
keycard switches



**P. 798**  
TV sockets,  
audio/video sockets



**P. 806**  
Plates and supports

### Specific functions for healthcare buildings



**P. 809**  
Antimicrobial call units  
and nurse call units  
for day hospitals...



**P. 818**  
Antimicrobial bedhead  
strips

## NEW PRODUCTS 2014



### Colour lighting management

solutions to create lighting ambiances in up to 4 areas  
(p. 787)



### USB chargers

2 modules  
Mosaic™ Programme  
(p. 793)





**P. 786**  
Sensitive switch,  
touch switches,  
automatic switch  
and switch sensors



**NEW**  
**P. 787**  
Dimming control  
and color lighting  
management



**P. 789**  
Time switches,  
temperature  
regulation



**P. 790**  
Roller blind  
controls



**P. 792**  
International standards  
socket outlets



**P. 793**  
USB chargers



**P. 794**  
Protection  
mechanisms,  
buzzers and bells



**P. 795**  
RJ 45, data and  
telephone sockets



**P. 801**  
Wi-Fi access points,  
rear pluggable  
RJ 45 sockets



**P. 802**  
Illuminated  
signs



**P. 803**  
Surface-mounting  
boxes and adaptors



**P. 805**  
Workstation kits



**P. 810**  
Antimicrobial call  
units for rooms and  
bathrooms



**P. 811**  
Antimicrobial  
control units for  
bedhead strips



**P. 812**  
BUS/SCS  
antimicrobial  
nurse call units



**P. 816**  
Antimicrobial  
snap-on trunking



**P. 822**  
Lighting to assist with  
independent living



**P. 823**  
Isolating transformers  
for hospitals

# Mosaic™ Programme

switches, pull-cord switches and ventilation control



Selection chart for boxes, supports and plates **p. 804-805**

All two-way switches with indicator have a terminal for neutral connection and have to be equipped with an indicator

## One-way switches 10 AX - 250 V~

Pack	Cat.Nos	Description
10	0 770 00	Fast connection via automatic terminals, no tool required <b>1 module</b> ○ White
10	0 770 10	<b>2 modules</b> ○ White

## Two-way switches 10 AX - 250 V~

Pack	Cat.Nos	Description	
10	0 770 01	Fast connection via automatic terminals, no tool required <b>1 module</b> ○ White	
10	0 792 01		● Alu
10	0 787 10		○ White antimicrobial
10	0 770 11	<b>2 modules</b> ○ White	
10	0 792 11		● Alu
10	0 787 11		○ White antimicrobial
10	0 770 02	<b>1 module with LED indicator</b> ○ White	
10	0 792 02		● Alu
10	0 770 12	<b>2 modules with LED indicator</b> ○ White	
10	0 792 12		● Alu
10	0 787 12		○ White antimicrobial
10	0 770 21	<b>2 modules intermediate switch</b> ○ White	
10	0 792 21		● Alu

## Two-way switches 20 AX - 250 V~

Pack	Cat.Nos	Description
10	0 770 60	Screw terminals <b>1 module</b> ○ White
10	0 770 62	<b>1 module with LED indicator</b> ○ White
10	0 770 92	<b>2 modules</b> ○ White
10	0 770 94	<b>2 modules with LED indicator</b> ○ White

## 2-pole one-way switches

Pack	Cat.Nos	Description
10	0 770 50	<b>2 modules</b> ○ White
10	0 770 52	<b>2 modules with LED indicator</b> ○ White

## 2-pole two-way switches

Pack	Cat.Nos	Description
10	0 770 63	<b>2 modules</b> ○ White
10	0 770 64	<b>2 modules with LED indicator</b> ○ White

## Pull-cord switches

Pack	Cat.Nos	Description
1	0 770 14	Fast connection via automatic terminals, no tool required <b>Two-way switch, 10 AX - 2 modules</b> For controlling 230 V~ incandescent and halogen lamps up to 2300 W ○ White
1	0 770 44	<b>Two-way pushbutton - 6 A, with pull cord</b> <b>2 modules</b> ○ White
10	0 898 05	<b>Cord for pull mechanism</b> Length 1.5 m 

## Ventilation control

Pack	Cat.Nos	Description
1	0 770 27	Fast connection via automatic terminals, no tool required <b>Two-way switch</b> For direct control of controlled mechanical ventilation 10 AX - 250 V~ ○ White antimicrobial



# Mosaic™ Programme mechanisms

## pushbuttons and accessories



Selection chart for boxes, supports and plates **p. 804-805**

Pack	Cat.Nos.	Pushbuttons 6 A - 250 V~
10	0 770 30	Fast connection via automatic terminals, no tool required <b>1 module</b> ○ White ● Alu ○ White antimicrobial
10	0 792 30	
10	0 787 14	
10	0 770 40	<b>2 modules</b> ○ White ● Alu ○ White antimicrobial
10	0 792 40	
10	0 787 15	
10	0 770 33	<b>1 module with neon for indicator function</b> ○ White
<b>Two-way pushbuttons 6 A - 250 V~</b>		
10	0 770 31	<b>1 module</b> ○ White
10	0 770 41	<b>2 modules</b> ○ White
10	0 770 32	<b>1 module with LED indicator</b> ○ White ● Alu
10	0 792 32	
10	0 770 42	<b>2 modules with LED indicator</b> ○ White ● Alu ○ White antimicrobial
10	0 792 42	
10	0 787 16	
10	0 770 43	<b>2 modules with label-holder</b> ○ White antimicrobial

Pack	Cat.Nos.	Accessories
10	0 676 66	<b>Indicator lights</b> For illuminated function of Cat.Nos 0 770 02, 0 792 02 and 0 770 32/42. Connected by direct mounting Maintenance-free lamp (LED) 230 V. Consumption 0.15 mA
10	0 676 67	12 V – 24 V – 48 V DC consumption: 12 V : 0.2 mA ; 24 V : 0.9 mA ; 48 V : 2.7 mA AC consumption: 12 V : 0.4 mA ; 24 V : 1.2 mA ; 48 V : 3.7 mA
10	0 676 68	<b>Monitor lights</b> For indicator function of two-way switches Cat.Nos 0 770 02/12, 0 792 02/12 and 0 770 33 Connected by direct mounting Maintenance-free lamp (LED) Distributed phase wiring monitor light 230 V. Consumption 3 mA
10	0 676 65	Existing wiring monitor light 230 V. Consumption 3 mA
10	0 676 64	<b>Indicator for socket outlets and 2-pole switch</b> For indicator or illuminated function of Cat.Nos 0 770 12, 0 770 52, 0 770 62, 0 770 93/94, 0 792 12 and 0 792 32/42 230 V. Consumption 2.4 mA To be wired

Lighting management solutions,  
**p. 590, 592**



Nurse call units,  
**p. 809**



# Mosaic™ Programme mechanisms

sensitive switch, touch switches, automatic switch for time-lag switch and switch sensors



Selection chart for boxes, supports and plates **p. 804-805**

Pack	Cat.Nos	
1	0 766 66	<p><b>Sensitive switch 10 AX</b></p> <p>For controlling light sources by simply passing the hand close to the switch (maximum loads, see p. 788) Particularly suitable for applications in medical environments Up to 5 sensitive switches can be combined to control the same lighting circuit Supplied with LED indicator light ○ White - antimicrobial</p>
1	0 787 09	<p><b>Touch switches</b></p> <p>For controlling light sources and other functions by simply passing the hand close to the switch Particularly suitable for applications in medical environments Marking possible with label (supplied) to be put under the cover plate 2 modules</p> <p><b>Switch with neutral</b> Equipped with indicator light (LED) For controlling lamps (maximum loads, see p. 788): - Up to 1000 W for 230 V~ incandescent or halogen - Up to 500 VA for ELV halogen with ferromagnetic or electronic transformer ○ White antimicrobial</p>
1	0 787 13	<p><b>NO/NC contact pushbutton – not supplied</b> Equipped with LED indicator light and feedback indicator to be wired. Particularly suitable for controlling door releases and locks 12/24 V Supply: 12 V= Consumption: 0.2 W Contact: 12 or 24 V=&lt;, 5 A max. ○ White antimicrobial</p>
1	0 784 57	<p><b>Automatic switch for time-lag switch</b></p> <p>Without neutral, 2-wire To be associated with a time-lag switch (p. 77) Allows automatic turning on/off in a hall, staircase... Replaces a push-button The time delay setting must be the same as that of the time-lag switch White</p>

Pack	Cat.Nos	
1	0 784 52	<p><b>180° switch sensors - Detection field 15 m<sup>2</sup> - for small conference rooms and private offices</b></p> <p>Wall mounting Automatic lighting management for places benefiting from natural light (private offices/open space offices, meeting rooms,...) Functioning: - occupancy mode: automatic on/off switching upon detection - vacancy mode: manual switching on with pushbutton, automatic switching off Factory pre-set: time delay 15 minutes, light level threshold 500 lux for false ceiling sensors, 300 lux for flush-mounting sensors Precise adjustment through mobile configurators</p> <p><b>Vacancy mode with neutral</b>  Dual tech - Maximum range 10 m – IP 41 ○ White ○ Grey</p> <p><b>Vacancy mode without neutral</b>  PIR - Maximum range 10 m – IP 41 ○ White ○ Grey</p>
1	0 792 52	
1	0 784 53	<p><b>180° switch sensors – Detection field 15 m<sup>2</sup> – movement detection</b></p> <p>Wall mounting Automatic lighting management for little frequented passageways (garage, stockroom, corridor,...) Functioning: automatic on/off switching upon detection Manual adjustment of light level threshold and time delay via thumbwheel/screwdriver Factory pre-set to occupancy mode  PIR - Maximum range 10 m – IP 41 Screw terminal connection</p> <p>○ White - With neutral ○ Grey - With neutral ○ White - Without neutral ○ Grey - Without neutral</p>
1	0 792 53	



# Mosaic™ Programme mechanisms

## dimming control



Selection chart for boxes, supports and plates **p. 804-805**

All dimmer switches have separate buttons on the front face for switching on/off and for +/- dimming  
 Can be remotely controlled via non-illuminated pushbuttons (p. 785), with each pushbutton able to perform the dimming function  
 When switched on, lighten at the level set before last switched off  
 For installation in flush-mounting box depth 40 mm min.

Pack	Cat.Nos	Dimmer switches 110-230 V~ - 50 Hz
1	2 modules 0 784 07	<p>All dimmer switches (except for Cat.No 0 784 05) can be used as two-way switches in combination with a switch (p. 784)</p> <p><b>Universal dimmers</b>                      Without neutral, 2 wires                      Push-button dimmer for all types of lamps :                      - dimmable LEDs: 75 W (10 lamps max.)                      - dimmable compact fluorescent lamps: 75 W (10 lamps max.)                      - halogen with transformer: 400 VA                      - fluorescent tube: 200 VA                      - halogen 230 V and incandescent: 400 W                      Can be associated with one or several push-buttons without neon, for ON/OFF or dimming control                      Lights come on again at the same lighting level as before they were last switched off</p> <p> White   Alu</p>
1	0 792 07	
1	0 784 05	<p><b>Dimmer 600 W</b>                      For controlling lamps: see opposite                      Status memory function. Can be controlled (on/off/dimming) via one or more pushbuttons</p> <p> White</p>
1	5 modules 0 784 02	<p><b>With neutral, 3-wire, 1000 W</b>                      For controlling lamps: see opposite                      5 LEDs displaying the current level of the circuit</p> <p> White finish cover plate</p>
1	2 modules 0 784 04	<p><b>Dimmer switch 0-10 V</b>                      For controlling lamps: see opposite</p> <p> White</p>
1	2 modules 0 784 10	<p><b>Auxiliary control unit for DIN dimmer</b>                      Remote control dimming peripheral for local control of a remote control dimmer, with the same easy operation as a conventional dimmer                      A power supply Cat.No 0 036 80 is required for controlling DIN-rail modular remote control dimmers Cat.Nos 0 036 60/71 (p. 78)</p>

# Mosaic™ Programme

## color-lighting management



Pack	Cat.Nos	Color-lighting dimmers
1	0 784 03	<p>Allow the user to create lighting ambiances                      For (LEDs) DALI ballasts and drivers                      For controlling max. 21 RGB (Red/Green/Blue) luminaires                      Configuration via "learn" button                      Ideal for show-rooms, shops, restaurants, hotels, beauty salons...                      Work with power supply Cat.No 0 035 15                      White</p> <p><b>Dimmer - 1 area</b>                      Allows manual change of colors</p>
1	0 488 60	<p><b>Touch dimmer - 1 to 4 areas</b>                      Allows the creation of up to 4 lighting ambiances in up to 4 areas                      Multicolor dimming                      Light adjustments:                      - colors: via touch chromatic circle                      - intensity: via bargraph</p> <p>Supplied with support                      For installation in 2-module flush-mounting box depth 50 mm</p>
1	0 035 15	<p><b>DALI power supply</b>                      For installation in false ceiling                      Works with color-lighting dimmers Cat.Nos 0 784 03 and 0 488 60                      230 V - 250 mA - 16 V=</p>







Lighting management solutions,  
**p. 590-592**

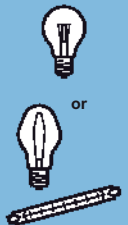

# Mosaic™ Programme mechanisms

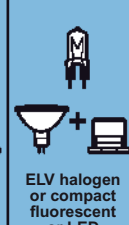
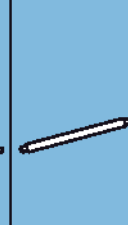
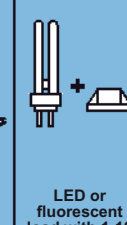

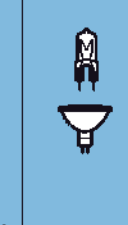
## maximum loads

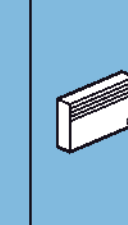
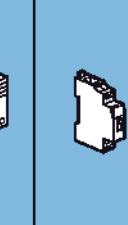
### Switches and dimmers maximum loads at 230 V<sub>~</sub>

Cat.Nos	 Incandescent or halogen lamps	 ELV halogen with ferromagnetic transformer	 ELV halogen or compact fluorescent or LED with electronic transformer	 Fluorescent tube	 LED or fluorescent load with 1-10 V <sub>~</sub> electronic ballast	 Compact fluorescent and dimmable compact fluorescent bulb	 LED bulb	 Motor	 Backup heating system	 Contactor
<b>Sensitive switches</b>										
0 766 66	1000 W	500 VA	500 VA	500 VA	-	500 VA	-	100 VA	1000 W	I max ≤ 2A
<b>Dimmer switches</b>										
0 784 02	100 W 1000 W	100 VA 1000 VA	100 VA 1000 VA	-	-	-	-	-	-	-
0 784 04	-	-	-	-	40 VA 600 VA	-	-	-	-	-
0 784 05	40 W 600 W	40 VA 600 VA	-	-	-	-	-	-	-	-
0 784 07	3 W 400 W	3 VA 400 VA	3 VA 400 VA	3 VA 200 VA	-	3 W 75 W (10 lamps maxi)	3 W 75 W (10 lamps maxi)	-	-	-
<b>Switch sensors</b>										
0 784 53 0 792 53 0 784 55 0 792 59	40 W 400 W	40 VA 400 VA	40 VA 400 VA	-	-	-	20 VA 400 VA <sup>(2)</sup>	-	-	-
0 784 52 0 792 52 0 784 54 0 792 58	2000 W	1000 VA	1000 VA	10 x (2 x 36 W)	-	250 VA	500 VA	-	2000 W	I max ≤ 2 A
<b>Timer switch</b>										
0 784 20	1000 W	400 VA	400 VA	-	-	-	-	250 VA	1840 W	-
<b>Programmable time switch</b>										
0 784 25	1200 W	1800 VA	2300 VA	-	-	100 VA <sup>(1)</sup>	-	1800 VA	-	-
<b>Touch switch</b>										
0 787 09	1000 W	500 VA	500 VA	500 VA	-	500 VA	500 VA	100 VA	1000 W	I max ≤ 2 A

1: Does not work with dimmable compact fluorescent bulb  
2: Works with dimmable LED bulbs

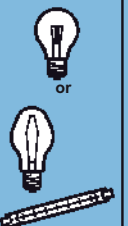
### Compatibility of switches with light indicator (without neutral)

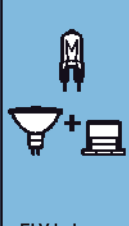
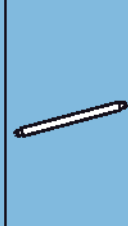
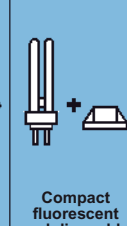
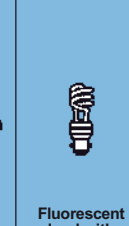
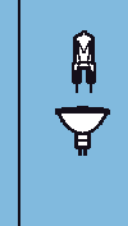
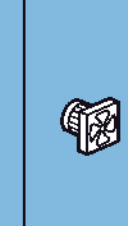
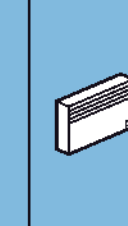
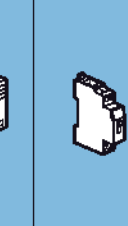
Cat.Nos	 Incandescent or halogen lamps	 ELV halogen with ferromagnetic transformer	 ELV halogen with electronic transformer	 Fluorescent tube	 Compact fluorescent and dimmable compact fluorescent bulb	 Fluorescent load with 1-10 V <sub>~</sub> electronic ballast	 LED bulb	 Motor	 Backup heating system	 Contactor
<b>Indicator light</b>										
0 676 66	YES	YES	YES	NO	NO	NO	NO	YES	YES	NO
<b>Illuminated supports</b>										
0 802 60 0 802 57 0 802 58	YES	YES	YES	NO	NO	NO	NO	YES	YES	NO

## Mosaic™ Programme mechanisms

timer switch, programmable time switch



0 784 20



0 784 25

Selection chart for boxes, supports and plates **p. 804-805**

Pack	Cat.Nos	Timer switch
1	0 784 20	<p>Interference suppression conforming to standard EN 55022</p> <p>For timer control of a circuit with the following loads:</p> <ul style="list-style-type: none"> <li>- 1000 W 230 V~ incandescent and halogen</li> <li>- 1840 W resistive (heating)</li> <li>- 400 VA fluorescent and ELV halogen</li> </ul> <p>It is possible to install a number of timer switches in parallel on the same circuit</p> <p>2-wire installation in 40 mm min. box</p> <p>Has an integrated LED. 2 modules</p> <p>○ White</p>
1	0 784 25	<p><b>Programmable time switch</b></p> <p>20 hours working reserve</p> <p>Capacity: 8 weekly programmes</p> <p>Temporary or permanent override</p> <p>1 output - 6 A - 250 V~ cos <math>\Phi = 1</math></p> <p>1 changeover contact</p> <p>Used to programme the control of a circuit with the following loads:</p> <ul style="list-style-type: none"> <li>- 1200 W 230 V~ incandescent and halogen</li> <li>- 1800 VA fluorescent <math>\varnothing 26</math> or 38 mm and ELV halogen with ferromagnetic or electronic transformer</li> <li>- 1800 W motors (ventilation only)</li> <li>- 3600 W resistive (heating only)</li> </ul> <p>○ White</p>

## Mosaic™ Programme mechanisms

heating, temperature regulation



0 767 20



0 767 21

Selection chart for boxes, supports and plates **p. 804-805**

Fast connection via automatic terminals, no tool required

Pack	Cat.Nos	Room thermostats
1	2 modules 0 767 20	<p>Power supply 230 V~ - 50/60 Hz</p> <p>Suitable for regulation of ceiling panel heating and direct floor heating</p> <p><b>Electronic</b></p> <p>Adjustment range from 5 °C to 30 °C</p> <p>Adjustment accuracy +/- 0.5 °C (category B)</p> <p>One output by non-powered contact</p> <p>Pushbutton on front face for selecting the operating mode (off, switch off when temperature falls or rises)</p> <ul style="list-style-type: none"> <li>• LV use</li> </ul> <p>Breaking capacity:</p> <ul style="list-style-type: none"> <li>- 8 A / 230 V~ - resistive circuit</li> <li>- 2 A / 230 V~ - inductive circuit</li> </ul> <ul style="list-style-type: none"> <li>• ELV use</li> </ul> <p>Breaking capacity from 1 mA min. to 500 mA max.</p> <p>12 to 48 V~ / 12 to 24 V=</p> <p>○ White</p>
1	5 modules 0 767 21	<p><b>Electronic with weekly programming</b></p> <p>Provides temperature regulation for oil, gas and electric heating installations in comfort, reduced and frost-free modes</p> <p>Permanent display of the current programme</p> <p>4 preset programmes, 1 free programme, 4 time periods max. per day, 2 adjustable temperature levels</p> <p>Adjustment range: 7 °C to 30 °C</p> <p>Adjustment accuracy: <math>\pm 0.5</math> °C (category B)</p> <p>Permanent backup of programmes</p> <p>Working reserve 100 h</p> <p>1 output by changeover contact</p> <p>Breaking capacity:</p> <ul style="list-style-type: none"> <li>- 8 A - 250 V~ - resistive circuit</li> <li>- 2 A - 250 V~ - inductive circuit</li> <li>- 1 to 500 mA max. - 12 to 48 V~</li> </ul> <p>○ White</p>
1	2 modules 0 767 23	<p><b>Sensor for DIN-rail modular thermostat</b></p> <p>Measures the temperature for DIN-rail modular thermostat</p> <p>To be installed with a support (p. 808)</p> <p>○ White</p>

# Mosaic™ Programme mechanisms

## roller blind controls



0 787 05



0 792 28



0 784 27

Selection chart for boxes, supports and plates **p. 804-805**

Fast connection via automatic terminals, no tool required

Pack	Cat.Nos	Roller blind switches
10 1 1	0 770 26 0 792 26 0 787 05	<p><b>For direct raise/lower/stop control of 500 W max. blind, awning or canopy motor</b></p> <ul style="list-style-type: none"> <li><input type="radio"/> White</li> <li><input type="radio"/> Alu</li> <li><input type="radio"/> White antimicrobial</li> </ul>
10 1	0 770 25 0 792 25	<p><b>Roller blind pushbuttons</b></p> <p><b>For 1 roller blind</b> For controlling 500 W max. blind, awning or canopy motor by electronic control box</p> <ul style="list-style-type: none"> <li><input type="radio"/> White</li> <li><input type="radio"/> Alu</li> </ul>
10 1	<b>N</b> 0 770 28 0 792 28	<p><b>For 1 or several roller blinds</b> For direct control of motors Can be associated with multiple control relay Cat.No 0 676 22 (2 positions: up/down)</p> <ul style="list-style-type: none"> <li><input type="radio"/> White</li> <li><input type="radio"/> Alu</li> </ul>
1 1	0 784 27 0 791 27	<p><b>Radio/ZigBee® roller blind controls</b></p> <p>Individual or centralized controls, depending on setting Management of the electronic end stop included in the programmable opening setting Functioning via 2.4 GHz Radio waves 2 modules</p> <p><b>230 V~ controls</b> To be flush-mounted in boxes depth 50 mm recommended</p> <ul style="list-style-type: none"> <li><input type="radio"/> White</li> <li><input type="radio"/> Alu</li> </ul>
1 1	0 784 28 0 791 28	<p><b>Wireless wall-mounted controls</b> Equipped with Lithium 3 V CR 2032 batteries Mounting accessories supplied To be installed directly on the wall, without a flush-mounting box</p> <ul style="list-style-type: none"> <li><input type="radio"/> White</li> <li><input type="radio"/> Alu</li> </ul>
1	0 766 90	<p><b>Single pole relay</b></p> <p>Used to bring functions with low breaking capacity close to the application Resistive: 3000 W Incandescent: 1800 W LV halogen: 1800 W Fluorescent: 400 VA Motors (roller blind type): 530 W 2 modules</p>
1	<b>N</b> 0 676 22	<p><b>Multiple control relay</b></p> <p>For controlling several roller blinds simultaneously To be mounted in flush-mounting box depth 40 mm</p>

# MOSAIC™ PROGRAMME

# Mosaic™ Programme

ensures  
**adaptability**

Get power & data delivered just where users need it through innovative functions and ergonomic designs.

## DISCOVER OUR SOLUTIONS

- Flexible and evolving installations : false floor, false ceiling, trunkings,... the Mosaic™ Programme offers numerous different installation modes, adapted for high currents and data networks
- Ergonomic and aesthetic solutions elaborated for a perfect integration in your office environment



■ Pop-up boxes  
See p.777



■ Meeting room multi-outlet extensions  
See p.781

Discover the pop-up type flush-mounting boxes,  
**see e-catalogue**





# Mosaic™ Programme mechanisms

keyswitches, emergency stop pushbuttons, keycard switches, hotel bedroom indicators, shaver socket



0 770 72



0 770 75



0 766 01



0 784 80



0 770 47

Selection chart for boxes, supports and plates **p. 804-805**

Pack	Cat.Nos	Keyswitches
1	0 770 72	<p>2 modules</p> <p><b>2-position switch</b> By changeover contact 6 A - 250 V~ RONIS key no. 601 Key can be removed in both positions  White</p> <p><b>3-position switch</b> Changeover switch with OFF position 6 A - 250 V~ RONIS key no. 601 Key can be removed in all 3 positions  White</p> <p><b>2-position switch - European key barrel</b> 1 contact - 2 poles 6 A - 250 V~ Key can be removed in both positions Must be fitted with standard European key barrel or key barrel Cat.No 0 697 95  White</p> <p><b>3-position pushbutton- European key barrel</b> Changeover switch with OFF position 6 A - 250 V~ Must be fitted with standard European key barrel or key barrel Cat.No 0 697 95  White</p> <p><b>European key barrel</b> European key barrel supplied with one set of 3 keys </p>
1	0 770 73	<p><b>3-position pushbutton- European key barrel</b> Changeover switch with OFF position 6 A - 250 V~ Must be fitted with standard European key barrel or key barrel Cat.No 0 697 95  White</p>
1	0 770 74	<p><b>2-position switch - European key barrel</b> 1 contact - 2 poles 6 A - 250 V~ Key can be removed in both positions Must be fitted with standard European key barrel or key barrel Cat.No 0 697 95  White</p>
1	0 770 75	<p><b>3-position pushbutton- European key barrel</b> Changeover switch with OFF position 6 A - 250 V~ Must be fitted with standard European key barrel or key barrel Cat.No 0 697 95  White</p>
1	0 697 95	<p><b>European key barrel</b> European key barrel supplied with one set of 3 keys </p>
1	0 766 01	<p><b>Emergency stop mushroom head pushbuttons</b></p> <p>2 modules</p> <p><b>With key</b> NO + NC 3 A - 250 V~ Unlock with RONIS key no. 455  Red/yellow</p> <p><b>1/4 turn</b> NO + NC 3 A - 250 V~ 1/4 turn unlocking  Red/yellow</p>
1	0 766 02	<p><b>1/4 turn</b> NO + NC 3 A - 250 V~ 1/4 turn unlocking  Red/yellow</p>

Pack	Cat.Nos	Keycard switches
1	0 784 80	<p>For energizing a circuit by inserting an ISO format card (e.g: Cat.No 0 767 11 or hotel room access card) Time-delay: 30 sec. after card removal Backlight insert badge area 2 modules</p> <p><b>Electronic keycard switches</b>  Operates via contact with ISO card or key fob Cat.No 0 898 06 Communication: BUS/SCS</p>
1	0 767 28	<p> Only operates with MIFARE contactless ISO badge cards (e.g Cat.Nos 0 767 11/12/13) Contact capacity: - 110 V, power 15 VA - 230 V, power 30 VA</p>
1	0 784 45	<p><b>Mechanical keycard switches</b>  Operates via contact with ISO card or key fob Cat.No 089806 Contact capacity: - 110 V, power 15 VA - 230 V, power 30 VA</p>
1	0 898 06	<p> Key fob Supplied complete with a label holder for individual hotel identification</p>
5	0 770 47	<p><b>Hotel bedroom indicators</b></p> <p>Indicator lamp and bell push Enables the resident to inform hotel staff of the room status Two settings are possible: - do not disturb - please clean the room  Installed in the corridor, displays calls Supplied with lamps</p>
5	0 770 48	<p> Allows the user to select the desired setting Supplied with lamp Cat.No 0 676 68 (p. 785)</p>
1	0 775 86	<p><b>Shaver socket IP 24 - IK 04</b></p> <p>Conform to EN 60742 and EN 61558-2 Power supply 230 VA - 50/60 Hz and 1 output 120/220 V~ Connection via automatic terminals Equipped with a circuit separation transformer to isolate the user from the mains supply Protected against overloads and short circuits by built-in thermal relay limiting the available power to 20 VA Insertion of the plug activates the power supply to the transformer  With integrated support For flush mounting 2 gang boxes only, 40 mm deep 5 modules</p>

# Mosaic™ Programme mechanisms

multi-support single and multiple sockets: German standard



Selection chart for boxes, supports and plates **p. 804-805**

Pack	Cat.Nos	Multi-support single sockets - German standard	
		For installation in flush-mounting box, surface-mounting box, floor box, column module, desktop multi-outlet extension, office module and trunking 2 modules	
10	0 772 11	<b>2P+E with shutters for child protection</b> <ul style="list-style-type: none"> <li>○ White - automatic terminals</li> <li>○ White - with special tap-off screw and 4 mm<sup>2</sup> screw terminals</li> <li>● Red - automatic terminals</li> <li>● Alu - screw terminals</li> <li>○ White antimicrobial - screw terminals</li> <li>● Green antimicrobial - automatic terminals</li> <li>● Orange antimicrobial - automatic terminals</li> <li>● Red antimicrobial - screw terminals</li> </ul>	
10	0 772 13		
10	0 772 18		
10	0 792 13		
10	0 787 02		
10	0 772 16		
10	0 772 17		
10	0 772 20		
10	0 772 10		<b>2P+E without child protection</b> <ul style="list-style-type: none"> <li>○ White - screw terminals</li> </ul>
10	0 772 45		<b>2P+E angled 45°</b> <ul style="list-style-type: none"> <li>○ White - automatic terminals</li> </ul>
10	0 772 14	<b>2P+E tamperproof</b> <ul style="list-style-type: none"> <li>● Red - screw terminals</li> </ul> To be used with the tamperproof insert Cat.No 0 502 99	
1	0 772 31	<b>2P+E "Access Design"</b> Special for disabled persons Simple action on the lever allows easy plug-in or unplug <ul style="list-style-type: none"> <li>○ White antimicrobial</li> </ul>	
10	0 772 19	<b>2P+E with cover</b> <ul style="list-style-type: none"> <li>○ White antimicrobial - automatic terminals</li> </ul>	
10	0 772 12	<b>2P+E with indicator</b> <ul style="list-style-type: none"> <li>○ White antimicrobial - automatic terminals</li> </ul> Indicator 230 V - 2.4 mA supplied	

Pack	Cat.Nos	Multi-support multiple sockets - German standard	
		For installation in flush-mounting box, surface-mounting box, floor box, column module, desktop multi-outlet extension and office module Inclined 45° Connection by automatic terminals	
10	0 772 52	<b>2 x 2P+E</b> <ul style="list-style-type: none"> <li>○ White</li> <li>○ White - with indicator 230 V - 2.4 mA (supplied)</li> <li>● Alu</li> <li>● Red</li> <li>● Red - with indicator 230 V - 2.4 mA (supplied)</li> <li>● Red - tamperproof. To be used with tamperproof insert Cat.No 0 502 99</li> <li>● Red - tamperproof, with indicator 230 V - 2.4 mA (supplied). To be used with tamperproof insert Cat.No 0 502 99</li> </ul>	
10	0 772 90		
10	0 792 82		
10	0 772 72		
10	0 772 91		
10	0 772 81		
10	0 772 92		
10	0 772 53		<b>3 x 2P+E</b> <ul style="list-style-type: none"> <li>○ White</li> <li>● Alu</li> <li>● Red</li> <li>● Red - tamperproof. To be used with tamperproof insert Cat.No 0 502 99</li> </ul>
10	0 792 83		
10	0 772 82		
10	0 772 73		
5	0 772 54	<b>4 x 2P+E</b> <ul style="list-style-type: none"> <li>○ White</li> <li>● Red</li> <li>● Red - tamperproof. To be used with tamperproof insert Cat.No 0 502 99</li> </ul>	
5	0 772 83		
5	0 772 74		
10	0 502 99	<b>Tamperproof insert</b> Tamperproof insert for socket Fits directly into the plug	

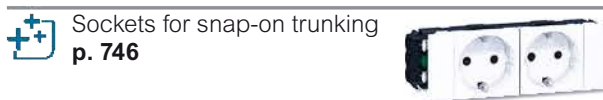

## Mosaic™ Programme mechanisms

### international standards socket outlets

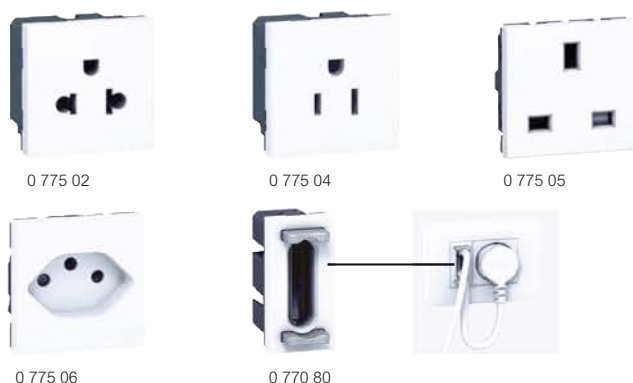

## Mosaic™ Programme mechanisms

### USB chargers



Selection chart for boxes, supports and plates **p. 804-805**

Pack	Cat.Nos	Other standard socket outlets
10	0 775 01	<b>Euro-US standard - white</b> 1 module
10	0 775 02	<b>Euro-US standard - white</b> 2 modules
10	0 775 03	<b>US standard - white</b> 1 module
10	0 775 04	<b>US standard - white</b> 2 modules - 15 A
10	0 775 05	<b>British standard - white</b> 2 modules - 13 A
10	0 775 10	<b>Italian type - white</b> 1 module - 10 A - screw terminals
10	0 775 11	<b>Italian type - white</b> 1 module - 10/16 A - screw terminals
10	0 775 12	<b>German-Italian standard</b> 2 modules - 16 A - screw terminals
10	0 775 06	<b>Swiss type - white</b> 2 modules - type 13
10	0 775 08	<b>Danish standard - white</b> 2 modules - with shutters for child protection
10	0 775 09	<b>Danish standard - white</b> 2 modules - for UPS - with shutters for child protection
10	0 771 50	<b>2P ELV socket outlet</b> With shutters for child protection For installation in flush-mounting box, surface-mounting box, floor box, column module, desktop multi-outlet extension, office module and trunking 1 module - white antimicrobial
1	0 770 80	<b>Anti-extraction module</b> When used with a socket, avoids accidental unplugging of sensitive electrical equipment, by gripping the cord (Ø4 to 8 mm cords) Can withstand an extraction force of 350 N (35 kgs) 1 module - white antimicrobial

Selection chart for supports and plates **p. 804-805**  
Technical characteristics, **see e-catalogue**

Pack	Cat.Nos	USB power supplies
5	0 775 94	<b>Double USB sockets - 5V- 1500 mA</b> For telephones, smartphones, MP3/MP4 players and fast-charging tablet PC 2 modules <ul style="list-style-type: none"> <li>○ White</li> <li>● Alu</li> </ul>
1	0 793 94	
10	0 775 91	<b>Single USB sockets - 5V - 750 mA</b> For telephones and smartphones 1 module <ul style="list-style-type: none"> <li>○ White</li> <li>● Alu</li> </ul>
1	0 793 91	
1	0 775 93	<b>USB power supplies with retractable cord</b> For recharging portable devices such as telephones and smartphones Single socket 5 V - 1000 mA equipped with a retractable cord with micro USB connector Conform to IEC 62684-2011-01 Consumption in passive mode < 0.2 W 2P+E tap-off connection via 2.5 mm² screw terminals Cord length : 30 cm <ul style="list-style-type: none"> <li>○ White</li> <li>● Alu</li> </ul>
1	0 793 93	
10	0 803 99	<b>Support for portable device on charge</b> For 1 portable device Prevents device from any fall risk and allows secure use of device while charging Wall-mounting Supplied with retractable cord: USB/Micro USB 60 cm, resistance > 7500 operations Charging and PC synchronisation possible Fixing tools supplied 



# Mosaic™ Programme mechanisms

voltage surge protector, replacement module, filter, buzzers, bells, blanking plates, cable outlets and proximity MCBs



Selection chart for supports and plates **p. 804-805**

Pack	Cat.Nos	Voltage surge protector
1	0 775 40	<p>16 A - 250 V<math>\sim</math> - 50/60 Hz                      Protection against overvoltages of atmospheric or industrial origin, in an installation already protected by a voltage surge protector in the panel (p. 64)                      For installation downstream of an RCBO, protects all the sockets wired in cascade with the voltage surge protector. Operation displayed by indicator light                      Keeps the socket energised after an overvoltage (mains or lightning strike) until replacement of module                      Cat.No 0 775 41                      Nominal discharge current (In): 1.5 kA                      Maximum permissible current (Imax): 6 kA                      Protection level (Up): L-N: 1 kV; N-PE: 1 kV                      Open circuit voltage (Uoc): 3 kV                      Conform to standards EN 61643-11</p> <p>White 2 modules</p>

1	0 775 41	<p><b>Replacement module for voltage surge protector</b>                      For Cat.No 0 775 40</p>
---	----------	---

1	0 775 42	<p><b>Filter</b>                      6 A - 250 V<math>\sim</math> - 50/60 Hz                      Supplied with fuse 5 x 20 - 6.3 A                      Cat.No 0 102 63                      Measurements conforming to standards CISPR 14 and 17                      Interference capacitors                      Measured attenuation of filter conforming to standards CISPR 14 and 17</p> <p>White</p>
---	----------	---

10	0 766 40	<p><b>Buzzers and bells</b>  <b>Buzzers - 2 modules</b>                      White - 8 V<math>\sim</math> - 50/60 Hz                      Consumption 370 mA                      Sound level 70 dB at 1 m</p>
10	0 766 41	<p>White - 230 V<math>\sim</math> - 50/60 Hz                      Consumption 25 mA                      Sound level 70 dB at 1 m</p>

1	0 766 42	<p><b>Electronic bell - 2 modules</b>                      White                      12-24-48 V<math>\equiv</math>                      Consumption 5-9-17 mA                      Depending on power supply                      Sound level 80 dB at 1 m</p>
---	----------	---

10	0 770 70	<p><b>Blanking plates</b>                      For Mosaic mechanisms</p> <p>White - 1 module</p>
10	0 792 70	<p>Alu - 1 module</p>
10	0 787 20	<p>White antimicrobial - 1 module</p>
10	0 770 71	<p>White - 2 modules</p>
10	0 792 80	<p>Alu - 2 modules</p>
10	0 787 21	<p>White antimicrobial - 2 modules</p>

Pack	Cat.Nos	Cable outlets
10	0 775 51	<p><b>16 A with cable grip - 2 modules</b>                      Equipped with 4 automatic connection terminals on the front and rear faces for easy connection</p> <p>White</p>
10	0 775 50	<p><b>20 A with cable grip - 2 modules</b>                      White</p>
10	0 775 52	<p><b>Ø8 mm wire outlet - 1 module</b>                      White</p>

1	0 775 21	<p><b>Proximity MCBs</b>                      Used for local protection of part of a circuit against overloads and short circuits                      Used in addition to the main protection device                      Due to its proximity to the user and its discrimination with the main protection device, the restart can be immediate</p> <p>2 modules                      Technical characteristics : see e-catalogue</p>
---	----------	--

1	0 775 21	<p><b>Single pole thermal magnetic MCB + Neutral 230 V<math>\sim</math></b>                      Can also be used as a local consumption limiter (depending on its rating)                      Breaking capacity: 3000 A - NF C 61-410 (10/16 A)                      1500 A - NF C 61-410 (6 A)</p> <p>White</p> <p>10 A 16 A</p>
---	----------	---

1	0 775 31	<p><b>Single pole RCBOs + Neutral 230 V<math>\sim</math></b>                      Provides additional protection of people (premises with conductive flooring, presence of water, etc.) against direct contact with live parts or earth leakages</p> <p>White</p> <p>10 A - 30 mA with test button 16 A - 30 mA with test button</p>
1	0 775 32	<p>10 A - 10 mA with test button</p>
1	0 775 33	<p>16 A - 10 mA with test button</p>

Din rail-mounting voltage surge protector, **p. 64**



Alarm, **p. 649**



# Mosaic™ Programme mechanisms

## RJ 45 sockets - cat. 6<sub>A</sub> and 6



Can be integrated in all supports (p. 808)  
 Contacts marked with dual colour code and wiring schemes T 568 A and T 568 B  
 Conform to standards ISO/IEC 11801 Ed. 2.0, amendment 2, EN 50173-1 and TIA/EIA C

Pack	Cat.Nos	Cat. 6 <sub>A</sub> RJ 45 sockets
10	0 765 73	<b>STP - 1 module</b> 360° metal shielding ○ White ○ Alu
10	0 794 73	
10	0 765 76	<b>STP - 2 modules</b> 360° metal shielding ○ White ○ Alu
10	0 794 76	
10	0 765 24	○ White with green shutter
10	0 765 25	○ White with orange shutter
10	0 765 08	○ White - angled 45°
5	0 765 99	<b>STP with controlled access - 2 modules</b> 360° metal shielding Supplied with 2 keys for 5 sockets ○ White with red shutter
10	0 765 71	<b>UTP - 1 module</b> ○ White ○ Alu
10	0 794 71	
10	0 765 26	○ White with green shutter
10	0 765 27	○ White with orange shutter
10	0 765 74	<b>UTP - 2 modules</b> ○ White ○ Alu
10	0 794 74	
5	0 765 90	<b>UTP with controlled access - 2 modules</b> Supplied with 2 keys for 5 sockets ○ White with red shutter
10	0 765 09	○ White

Pack	Cat.Nos	Cat. 6 RJ 45 sockets
10	0 765 61	<b>UTP - 1 module</b> ○ White ○ Alu ○ White antimicrobial
10	0 794 61	
10	0 765 81	
10	0 765 64	<b>UTP - 2 modules</b> ○ White ○ Alu
10	0 794 64	
5	0 765 94	<b>UTP with controlled access - 2 modules</b> Supplied with 2 keys for 5 sockets ○ White with red shutter
10	0 765 91	<b>UTP 90° - 2 modules</b> Vertical snap-on socket for column module ○ White
1	0 765 03	<b>UTP 45° - 2 modules</b> ○ White ○ White, connection with 110 tool
1	0 765 14	
1	0 765 04	<b>UTP 45° - 2 x RJ 45 - 2 modules</b> ○ White
5	0 765 32	<b>UTP retractable RJ 45 socket - 4 modules</b> With integrated retractable cord (0.9 m) Winds up automatically with a pushbutton ○ White
10	0 765 62	<b>FTP - 1 module</b> ○ White ○ Alu ○ White antimicrobial
10	0 794 62	
10	0 765 82	
10	0 765 65	<b>FTP - 2 modules</b> ○ White ○ Alu ○ White with green shutter ○ White with orange shutter
10	0 794 65	
10	0 765 22	
10	0 765 23	



## Mosaic™ Programme mechanisms

### RJ 45 sockets - cat. 6



Can be integrated in all supports (p. 808)  
 Contacts marked with dual colour code and wiring schemes T 568 A and T 568 B  
 Conform to standards ISO/IEC 11801 Ed. 2.0, amendment 2, EN 50173-1 and TIA/EIA 568 C

Pack	Cat.Nos	Cat. 6 RJ 45 sockets (continued)
5	0 765 95	<b>FTP with controlled access - 2 modules</b> Supplied with 2 keys for 5 sockets ○ White with red shutter
10	0 765 05	<b>FTP 45° - 2 modules</b> ○ White
5	0 765 06	<b>FTP 2 x RJ 45 45° - 2 modules</b> ○ White
1	0 765 33	<b>FTP retractable RJ 45 sockets - 4 modules</b> With integrated retractable cord (0.9 m) Winds up automatically with a pushbutton
1	0 794 33	○ White ● Alu
10	0 765 92	<b>FTP 90° - 2 modules</b> Vertical snap-on socket for column module
10	0 794 92	○ White ● Alu
10	0 765 63	<b>Shielded STP - 1 module</b> ○ White
10	0 765 83	○ White antimicrobial
10	0 765 66	<b>Shielded STP - 2 modules</b> ○ White
5	0 765 96	<b>Shielded STP with controlled access - 2 modules</b> Supplied with 2 keys for 5 sockets ○ White with red shutter
10	0 765 07	<b>STP 45° - 2 modules</b> Vertical snap-on socket for column module
10	0 765 93	<b>Shielded STP 90° - 2 modules</b> Vertical snap-on socket for column module
		○ White

## Mosaic™ Programme mechanisms

### RJ 45 sockets - cat. 5e



Can be integrated in all supports (p. 808)  
 Contacts marked with dual colour code and wiring schemes T 568 A and T 568 B  
 Conform to standards ISO/IEC 11801 Ed. 2.0, amendment 2, EN 50173-1 and TIA/EIA 568 C

Pack	Cat.Nos	Cat. 5e RJ 45 sockets
10	0 765 51	<b>UTP - 1 module</b> ○ White
10	0 794 51	● Alu
10	0 765 54	<b>UTP - 2 modules</b> ○ White
10	0 794 54	● Alu
5	0 765 97	<b>UTP with controlled access - 2 modules</b> Supplied with 2 keys for 5 sockets ○ White with red shutter
1	0 765 30	<b>UTP retractable RJ 45 socket - 4 modules</b> With integrated retractable cord (0.9m) Winds up automatically with a pushbutton
10	0 765 01	○ White
5	0 765 02	<b>2 x RJ 45 UTP 45° - 2 modules</b> ○ White
10	0 765 52	<b>FTP - 1 module</b> ○ White
10	0 794 52	● Alu
10	0 765 55	<b>FTP - 2 modules</b> ○ White
10	0 794 55	● Alu
5	0 765 98	<b>FTP with controlled access - 2 modules</b> Supplied with 2 keys for 5 sockets ○ White with red shutter

# Mosaic™ Programme mechanisms

## data and telephone sockets



0 765 35



0 786 17



0 787 66



0 787 61



0 787 32



Selection chart for boxes, supports and plates **p. 804-805**

Pack	Cat.Nos	
		<b>RJ 45 doubler sockets</b>
		1 module
10	0 765 39	<b>Ethernet/Ethernet</b>
10	0 765 38	FTP - 9 contacts UTP - 8 contacts
10	0 765 37	<b>Telephone/Ethernet</b>
10	0 765 36	FTP - 9 contacts UTP - 8 contacts
10	0 765 35	<b>Telephone/telephone</b> 45 contacts
		<b>Adaptors for RJ 45 connector</b>
		Equipped with transparent marker holder White - 2 modules
10	0 786 04	For single Keystone connector
10	0 786 10	For 2 Keystone connectors
10	0 786 02	For single Systemax connector
10	0 786 03	For double Systemax connector
10	0 786 09	For single Infra+ connector
10	0 786 11	For single Ortronics connector
10	0 786 12	For double Ortronics connector
		<b>Optical sockets - 2 modules</b>
		For connecting 2 fibres to the workstation Equipped with 1 duplex adaptor Supplied with protective caps
1	0 786 14	SC/APC single mode fiber optic socket
1	0 786 16	Socket with 2 ST optical adaptors bayonet connection
1	0 786 17	Socket with 2 SC optical adaptors push-pull connection
1	0 786 18	Socket with 2 LC optical adaptors push-pull connection
		<b>SUB D sockets - 2 modules</b>
1	0 787 65	9 contacts - Screw terminals connection to link type RS 232 series
1	0 787 67	9 contacts - Soldering connection to link type RS 232 series
1	0 787 66	15 contacts - Soldering connection For example used for specialized line type X21 between 2 distant devices

Pack	Cat.Nos	
		<b>Female USB data sockets - for data transfer</b>
		Used to bring connections closer to the user For connecting USB devices (scanner-printer, external hard disk) Max. cable length: 5 m. Recommended cable: USB A 1 module
		<b>Preterminated</b> USB 3.0. Equipped with a 15 cm cord
1	0 787 46	<input type="radio"/> White
1	0 787 61	<b>Connection via screw terminals</b> USB 2.0. Cross-section: 1 mm <sup>2</sup>
1	0 792 84	<input type="radio"/> White <input type="radio"/> Alu
		<b>Female USB amplifier - for data transfer</b>
		Used to bring connections closer to the user in case of large distances For connecting USB devices (digital school board / interactive whiteboard...) located more than 5 m away from a source (computer...) The kit includes a transmitter (1 module) and a receiver (1 module). The link between the transmitter and the receiver is made via a RJ 45 / RJ 45 cord
1	0 787 48	<input type="radio"/> White
		<b>Telephone sockets</b>
		<b>RJ 11 and RJ 12 sockets</b> Equipped with a modular Jack connector with 1/4 turn terminal for fast connection. Tap-off possible
10	0 787 30	<input type="radio"/> White - RJ 11, 4 contacts - 1 module
10	0 792 31	<input type="radio"/> Alu - RJ 11, 4 contacts - 1 module
10	0 787 31	<input type="radio"/> White - RJ 11, 4 contacts - 2 modules
10	0 787 32	<input type="radio"/> White - RJ 12, 6 contacts - 2 modules
		<b>ISDN socket</b> Self-stripping 1/4 turn terminals for fast connection Tap-off possible
10	0 787 34	<input type="radio"/> White - 8 contacts, 2.5 mm <sup>2</sup> earth terminal
		<b>Flush-mounting telephone/Ethernet double connectors</b>
		Provide increased security against theft and damage to double connectors Provide a rate of 10/100 Mbps Multidirectional cable entry Can be installed in all supports min. 35 mm deep Telephone and Ethernet applications marked on the protective flap
10	0 765 37	FTP
10	0 765 36	UTP

## Mosaic™ Programme mechanisms

### TV/R/SAT sockets



0 787 86

0 787 84

Selection chart for boxes, supports and plates **p. 804-805**

Pack	Cat.Nos	Television sockets
		For hertzian and satellite installation (with individual demodulator) DTT and HDTV compatible. Shielded sockets TV: male connector (Ø9.5 mm) R: female connector (Ø9.5 mm) SAT: "F" type connector Recommended coaxial cable: 17/19 VATC
		<b>TV-R-SAT sockets</b> TV: 5-68 / 120-862 Mhz R: 87.5-108 Mhz SAT: 950-2400 Mhz Star -1.5 dB. 2 modules
10	0 787 86	○ White
10	0 792 96	● Alu
		<b>TV-R sockets</b> TV: 5-68 / 120-862 Mhz R: 87.5-108 Mhz 2 modules
10	0 787 83	○ White. Star -1.5 dB
10	0 787 87	○ White. Pass-through -14 dB
10	0 787 88	○ White. Terminal -10 dB
		<b>TV-R socket (cable operator design)</b>
10	0 787 84	○ White - 2 modules. Star -1.5 dB
		<b>Single male TV sockets - Ø9.52 mm</b> TV: 0-2400 Mhz
5	<b>N</b> 0 787 93	○ White - 1 module. Star -1.5 dB
10	0 787 82	○ White - 2 modules. Star -1.5 dB
10	0 792 92	● Alu - 2 modules. Star -1.5 dB
10	6 771 37	○ White - 2 modules. Pass-through -14 dB
10	6 771 38	○ White - 2 modules. Terminal -10 dB
		<b>"F" type TV socket – with screws</b> SAT: 0-2400 Mhz
10	0 787 80	○ White - 2 modules. Star - 1.5 dB

## Mosaic™ Programme mechanisms

### audio sockets



0 787 55

0 787 60

0 787 50

0 787 76

Selection chart for boxes, supports and plates **p. 804-805**

Pack	Cat.Nos	Audio sockets
		<b>XLR 3-pin - 2 modules</b> Provide the stereo link for microphone, amplifier, mixing console, etc. Recommended cable: 1 audio pair 0.14 mm <sup>2</sup> to 0.5 mm <sup>2</sup> shielded Max. cable length: 50 m (without amplifier)
1	0 787 55	○ White - fast screw connection female
1	0 792 55	● Alu - fast screw connection female
1	0 787 56	○ White - fast screw connection male
		<b>4-pole Speakon – 2 modules</b> Used to connect power enclosures Recommended cable: 2 audio pairs 4 mm <sup>2</sup> Max. cable length: 50 m (without amplifier)
1	0 787 60	○ White - fast screw connection female
		<b>Loudspeakers sockets</b> Terminal 4 mm <sup>2</sup>
10	0 787 51	○ White - 2 modules
10	0 787 50	○ White - 1 module
10	0 792 50	● Alu - 1 module
		<b>100 V Line Volume Attenuator – 2 modules</b> Allows to adjust power and volume of a 100 V loudspeaker line
1	0 787 76	○ White - 100 V - 25 W



# Mosaic™ Programme mechanisms

## audio and video sockets



Selection chart for boxes, supports and plates **p. 804-805**

Pack	Cat.Nos	Female HD15 sockets	Jack sockets 3.5 mm
		Used to transmit analog video streams (VGA, XGA, UXGA depending on graphic card) between a source (computer) and a compatible receiver (video projector, TV...)	3.5 mm jack connectors can be used to create audio/video links
1	0 787 77	<b>Preterminated sockets - 1 module</b> Equipped with cord, length 15 cm	<b>Preterminated sockets - 1 module</b> Equipped with cord, length 15 cm
1	0 793 77	○ White ● Alu	○ White ● Alu
1	0 787 57	<b>Screw-type sockets - 2 modules</b>	<b>4 screw-type female 3.5 mm jack socket - 1 module</b>
1	0 792 57	○ White ● Alu	○ White ● Alu
1	0 787 74	<b>Screw-type socket + 3.5 mm jack - 2 modules</b>	<b>Solder-type female 3.5 mm jack socket - 1 module</b>
		○ White	○ White
1	0 787 72	<b>Solder-type socket - 1 module</b> 15 pin	<b>HD15 + 3.5 mm Jack amplifier</b>
		○ White	Used to connect audio/video terminals more than 20 m apart up to 100 m The video link is via an HD15 connector (resolution up to UXGA) The stereo audio link is via a 3.5 mm jack The kit includes: - one 4-module Mosaic transmitter equipped with an HD15 connector and a 3.5 mm jack - one 4-module Mosaic receiver equipped with an HD15 connector and a 3.5 mm jack - one 4-module Mosaic power supply to be connected on the mains then linked to the receiver or transmitter The link between the transmitter and receiver is via a network cord RJ 45 / RJ 45
1	0 787 78	<b>HDMI type A sockets</b>	1
1	0 793 78	Used to transmit high-definition digital audio/video streams between a source (computer, HD-DVD drive...) and a compatible receiver (TV, videoprojector...) Can be associated with HDMI cord and cable (see p. 696)	0 787 70
		<b>Preterminated HDMI 1.4 - 1 module</b> Equipped with cord, length 15 cm	○ White
1	0 787 68	○ White ● Alu	
1	0 792 75	<b>Screw-type sockets HDMI 1.3 - 2 modules</b>	
		○ White ● Alu	

Patch panels, cables and cords,  
**p. 696**



# Mosaic™ Programme mechanisms

## audio and video sockets (continued)



0 787 52



0 787 71

Pack	Cat.Nos	Videoprojector switch
1	0 787 99	<p>Universal remote switch allowing to turn ON or place in STANDBY mode a video projector Works with all videoprojectors or TV through IR learning process Installed close to the room's lighting switches, it replaces the constructors remote and fosters the ignition and extinction of the video projector therefore reducing energy consumption and extending the bulb's lifetime</p> <p> White</p>
1	0 787 91	<p><b>Display port sockets</b> Used to transmit high-definition digital audio/video streams between a source (laptop, computer, etc) and a compatible receiver (videoprojector, TV...)</p> <p><b>Preterminated socket - 1 module</b> Equipped with cord, length 15 cm</p> <p> White</p>
1	0 787 52	<p><b>Female 1 RCA socket</b> Provides the composite video link for any peripheral device such as a DVD drive, camera, video recorder, etc</p> <p>1 module</p> <p> White</p>
1	0 787 47	<p><b>Female 2 RCA sockets</b> Provide the stereo audio link for any peripheral device such as a DVD drive, camera, video recorder</p> <p>1 module</p> <p><b>Preterminated</b> Equipped with a 15 cm cord</p> <p> White</p>
1	0 787 53	<p><b>Connection via screw terminals</b></p> <p> White</p>
1	0 787 54	<p><b>Female 3 RCA sockets</b> Provide the composite video and stereo audio links for any peripheral device such as a DVD drive, camera, video recorder, videoconferencing, etc Connection via screw terminals</p> <p>1 module</p> <p> White</p>
1	0 792 54	

Pack	Cat.Nos	Other audio and video sockets
1	0 787 71	<p><b>DVI-I socket - 2 modules</b> Used to transmit high-definition digital video streams between a source (computer) and a compatible receiver (TV, video projector, etc)</p> <p> White</p>
1	0 787 58	<p><b>Female BNC 75 socket - 1 module</b> Provides the composite video link for any peripheral device such as a DVD drive, camera, video recorder, etc</p> <p> White</p>

# Mosaic™ Programme mechanisms

## Wi-Fi access points, LCS<sup>2</sup> rear pluggable RJ 45 sockets and switches



0 779 14



0 779 00



0 786 22



0 786 26

Selection chart for boxes, supports and plates **p. 804-805**  
 Technical characteristics **p. 715**

Pack	Cat.Nos	Wi-Fi access points
1	0 779 14	Standards 802.11a and 802.11b/g dual-band dual radio Data rate: 54 Mbps max. on each frequency (802.11a and 802.11g) Come in addition to a new or existing LCS <sup>2</sup> structured cabling, to meet the requirements for mobility in the building (meeting rooms for example) Identical connection to the LCS <sup>2</sup> RJ45 socket Remote management via a web interface Allow the configuration and the exploitation of the Wi-Fi access point by the network administrator Security via WPA2 encryption (802.11i) and/or authentication (802.11x) New: guest access to offer a free access to guests and keep independent and secure the main Wi-Fi network Supply via Power over Ethernet (standard 802.3 af) 4 modules 22.5 x 45 mm Equipped with an RJ 45 socket on the front panel White
1	0 779 13	Without RJ 45 socklet outlet White

Pack	Cat.Nos	Flush-mounting switches - LCS <sup>2</sup>
1	0 779 00	Non manageable switches For networking computer peripherals without a patch panel: computers, printers, servers, etc. Possibility of extending an existing network by simply replacing an RJ 45 socket Tool-free connection Conform with standards IEEE 802.3 (Ethernet) and EN 500 81/82-2 (EMC requirements) Installation in all supports with minimum 40 mm depth 6 ports at the front + 1 side RJ 45 connector for cabling and carrying out link tests Port status display integrated into the RJ 45 connectors Labelling of each port from 1 to 6 and marker holder for switch identification 6 modules 230 V supply PoE supply (802.3 ag)
1	0 779 01	

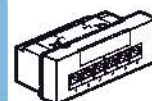

Pack	Cat.Nos	Rear pluggable RJ 45 sockets - LCS <sup>2</sup>
10	0 786 28	For use with area distribution boxes system Connection to boxes via RJ 45-RJ 45 cords Used to create Cat. 6 <sub>A</sub> , 6 and 5e links in accordance with standards ISO 11801 ed.2.0, EN 50173-1 and EIA/TIA 568 B2 Multi-directional cable entry Can be installed in all supports minimum depth 40 mm. 2 modules
10	0 786 29	
		<b>Cat. 6<sub>A</sub> STP</b> <input type="radio"/> White <input type="radio"/> Alu
10	0 786 23	<b>Cat. 6 FTP</b> 9 contacts <input type="radio"/> White <input type="radio"/> Alu
10	0 786 27	
10	0 786 22	<b>Cat. 6 UTP</b> 8 contacts <input type="radio"/> White <input type="radio"/> Alu
10	0 786 26	
10	0 786 21	<b>Cat. 5e FTP</b> 9 contacts <input type="radio"/> White <input type="radio"/> Alu
10	0 786 25	
10	0 786 20	<b>Cat. 5e UTP</b> 8 contacts <input type="radio"/> White <input type="radio"/> Alu
10	0 786 24	

RJ 45 for trunking,  
**p. 746**



# Mosaic™ Programme mechanisms

illuminated signage functions, bulkhead lights, indicator lights and downlighter

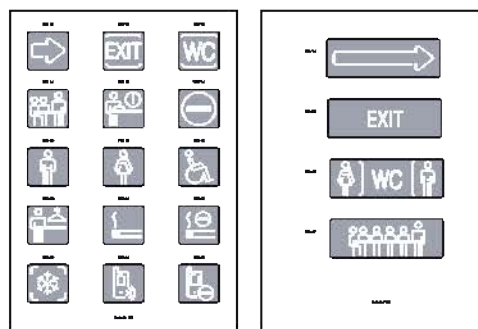
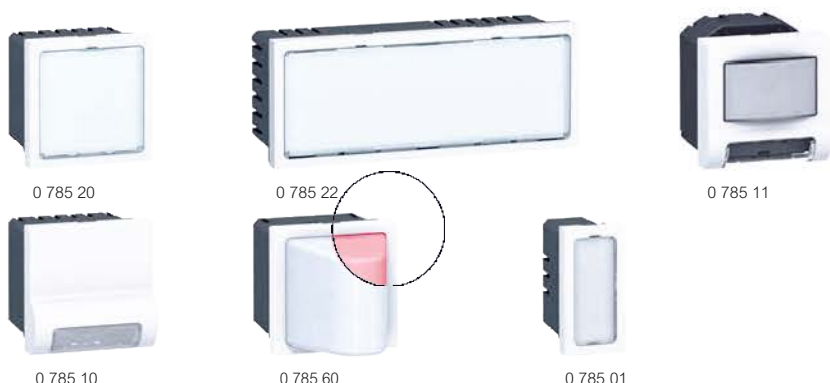

Preprinted labels available in e-catalogue

Selection chart for boxes, supports and plates **p. 804-805**

All the illuminated functions are equipped with very low consumption LEDs with an estimated service life of 100,000 hours

Pack	Cat.Nos	illuminated signs 230 V~	Pack	Cat.Nos	Bulkhead pilot light
		Mechanisms integrating LEDs and a pivoting window that can take preprinted labels (available in the e-catalogue) Customised labels can be printed using a simple text editor Supplied with transparent paper to personalize labels			To be installed in skirting trunking or bedhead strip 230 V - 2 modules White antimicrobial
5	0 785 20	Signs with white LEDs - 2 modules A choice of 2 power levels (0.2 W or 1 W)	1	0 785 10	
5	0 785 21	Signs with blue LEDs - 2 modules A choice of 2 power levels (0.2 W or 1 W)	10	0 785 60	<b>Bulkheads</b> 2 modules <b>12-24 V~ / = - 0.6 W</b>
5	0 785 24	Signs with 2-state LEDs with choice of green or red configurable on the mechanism (1 W) - 2 modules	10	0 785 61	● Red
1	0 785 22	Signs with white LEDs (1 W) 5 modules	10	0 785 62	○ White
1	0 785 23	Signs with blue LEDs (1 W) 5 modules	10	0 785 63	● Green
			10	0 785 70	<b>230 V~ (0.2 or 1 W)</b>
			10	0 785 71	● Red
			10	0 785 72	○ White
			10	0 785 73	● Green
					● Blue
					<b>Indicator lights</b>
					1 module For indicator or illuminated functions. Supplied with 4 coloured labels (red, orange, green and blue)
1	0 785 12	<b>Self-contained pilot light</b> During a power failure, automatically gives light using a high power white LED (stand-alone operation: 1 hour) Circular lighting by blue LED in standby mode - 2 modules Supplements the regulatory safety lighting system to meet high requirements (for child care centres, health, accessibility, retirement homes, etc.) Option of switching off by remote control	10	0 785 01	Single indicator 230 V (1 W) - Antimicrobial
			10	0 785 02	Double indicator 230 V (1 W) Antimicrobial
			10	0 785 51	Single indicator 12-24 V (0.2 W) Antimicrobial
			10	0 785 52	Double indicator 12-24 V (0.2 W) Antimicrobial
					<b>Illuminated obstacle indicator</b>
1	0 785 11	Mechanism equipped with an infrared detection cell and a LED beam For installation near an obstacle such as a step or a change of level 2 modules When a person passes, the mechanism detects his/her presence and lightens the obstacle The function is equipped with an audible signal that can be disengaged			<b>Downlighter</b>
			1	0 785 13	Skirting Light – Centralized supply ○ White

# Mosaic™ Programme surface-mounting boxes and adaptors



Selection chart for boxes, supports and plates **p. 804-805**

Pack	Cat.Nos	Surface-mounting boxes
5	0 802 80	<b>For 2 modules (support Cat.No 0 802 51)</b> Equipped with a 20 x 12.5 mm removable entry Depth 30 mm
5	0 802 81	
2	0 802 89	<b>For 3 modules (support Cat.No 0 802 59)</b> Equipped with a 20 x 12.5 mm removable entry Depth 40 mm
5	0 802 85	<b>For 4, 5 or 2 x 2 horizontal modules (support Cat.No 0 802 52)</b> Equipped with a 32 x 12.5 mm removable entry Depth 40 mm
5	0 802 86	<b>For 6, 8 or 3 x 2 horizontal modules (support Cat.No 0 802 53)</b> Equipped with a 32 x 12.5 mm removable entry Depth 40 mm
2	0 802 84	<b>For 10 or 4 x 2 horizontal modules (support Cat.No 0 802 54)</b> Equipped with a 40 x 20 mm removable entry Depth 40 mm
5	0 802 82	<b>For 5 or 2 x 2 vertical modules (support Cat.No 0 802 52)</b> Equipped with a 20 x 12.5 mm removable entry Depth 40 mm
5	0 802 83	<b>For 3 x 2 vertical modules (support Cat.No 0 802 53)</b> Equipped with a 20 x 12.5 mm removable entry Depth 40 mm
1	0 802 74	<b>For 2 x 5, 2 x 2 x 2 modules (support Cat.No 0 802 64) or lighting environment controller</b> Equipped with a 40 x 20 mm removable entry Depth 46 mm
1	0 802 76	<b>For 2 x 6, 2 x 8 or 2 x 3 x 2 modules (support Cat.No 0 802 66)</b> Equipped with a 40 x 20 mm removable entry Depth 46 mm
1	0 802 78	<b>For 2 x 10 modules (support Cat.No 0 802 68)</b> Equipped with a 40 x 20 mm removable entry Depth 46 mm

Pack	Cat.Nos	Modular support - 2.5 modules
10	0 802 99	For fixing Mosaic mechanisms on rail Width. 46.3 mm
		<b>Plexo 55 modular support frames IP 55 - IK 07</b>
		<b>For 2-module Mosaic mechanisms</b> Can be equipped with any Mosaic function in order to obtain an IP 55 wiring accessory
10	0 695 80	Adaptor with smoked polycarbonate flap
1	0 695 79	Adaptor with smoked polycarbonate flap lockable with special tool below (not supplied)
1	0 919 45	Security tool
		<b>For 3-module Mosaic mechanisms</b> Weatherproof IP 55 plate frames with membrane Allow operations of switches without opening cover maintaining IP 55 rating
1	6 806 32	White
1	6 806 33	Grey
		<b>Adaptors for mounting on Mosaic 50 mm supports</b>
		For replacing Mosaic mechanisms (50 x 50 mm) without having to change the plate or the support frame Enable a Mosaic mechanism to be mounted on Mosaic (50 x 50 mm) screw mounting support frames
10	0 791 54	Adaptor for 1-module mechanism (width 22.5 x 45 mm)
10	0 791 53	Adaptor for 2-module mechanisms (width 45 x 45 mm)

Mosaic™ Programme plates, **p. 806-807**



# Supports, plates and boxes for Mosaic™

		UNIVERSAL SUPPORTS		OTHER SUPPORTS ITALIAN STANDARD	MOSAIC PLATES (IP 44, see p. 806)		SURFACE MOUNTING BOXES		DRY PARTITIONS		
					Standard	Depth: (mm)	Cat. Nos	Depth: (mm)	Cat. Nos		
	1 module		0 802 50			0 788 01 0 790 01			40	0 800 40	
	2 modules		0 802 51 0 802 60 (illuminated) 0 802 62 (indicator) 0 802 61/69 (clip-mounting)			0 788 02 0 790 02	30 40		0 802 80 0 802 81	40 50 60	0 800 41 0 800 51 0 800 61
	3 modules		0 802 59 (with claws)	0 802 13		0 788 03 0 790 03	40		0 802 89	40	0 800 49
	4 modules			0 802 14		0 788 14 0 790 14					
	5 modules		0 802 58 (illuminated)			0 788 15 0 790 15	40		0 802 85		
	2 x 2 modules					0 788 04 0 790 04					
	5 modules	0 802 52				0 788 25 0 790 25	40		0 802 82	40 50	0 800 42 0 800 52
	2 x 2 modules		0 802 57 (illuminated)			0 788 22 0 790 22					
	6 modules			0 802 16		0 788 16 0 790 16					
	8 modules					0 788 18 0 790 18	40		0 802 86		
	3 x 2 modules		0 802 53			0 788 06 0 790 06				40 50	0 800 43 0 800 53
	3 x 2 modules					0 788 23 0 790 23	40		0 802 83		
	10 modules		0 802 54			0 788 10 0 790 10	40		0 802 84	40 50	0 800 44 0 800 54
	4 x 2 modules					0 788 08 0 790 08					
	2 x 5 modules		0 802 64			0 788 30 0 790 30	50		0 802 74		
	2 x 2 x 2 modules					0 788 38 0 790 38					
	2 x 6 modules					0 788 36 0 790 36					
	2 x 8 modules		0 802 66			0 788 37 0 790 37	50		0 802 76		
	3 x 2 x 2 modules					0 788 32 0 790 32					
	2 x 10 modules		0 802 68			0 788 28 0 790 28	46		0 802 78		

# Mosaic™ Programme workstation kits

flush-mounting or surface-mounting

MASONRY						MULTI-MATERIALS	
Batibox		Universal boxes		Italian type			
Depth (mm)	Cat.Nos	Depth (mm)	Cat. Nos	Depth (mm)	Cat. Nos	Depth (mm)	Cat. Nos
40	0 801 40						
40	0 801 41	40	(without screws) 0 313 01				
50	0 801 51			50	0 892 39		
40	without screws 0 801 08						
40	0 801 49						
				50	0 892 49		
40	2 x 0 801 41	40	2 x 0 313 01				
50	2 x 0 801 51						
		40	2 x 0 313 01				
				50	0 892 50		
40	3 x 0 801 41	40	3 x 0 313 01				
50	3 x 0 801 51						
		40	3 x 0 313 01				
40	4 x 0 801 41	40	4 x 0 313 01				
50	4 x 0 801 51						
						50	0 801 24
						50	0 801 26
						50	0 801 28



0 788 73



0 790 83

Ready-to-use kits to be equipped with low current and high current Mosaic™ Programme sockets (p. 792 to 800)  
Halogen free

Pack	Cat.Nos	Flush-mounting workstation kits
		To be installed with flush-mounting conduits Equipped with: - multi-materials flush-mounting box, depth 50 mm, with adjustable cable entries Ø 20 and 25 mm - 4-module independent supports for tool-less installation of Mosaic Programme mechanisms (2 optional screws supplied) - removable spacer for integration of 1-module mechanisms - separation partition for high currents and low currents
1	0 788 72	<b>For 2 x 4 modules</b> White
1	0 790 72	Alu
1	0 788 73	<b>For 3 x 4 modules</b> White
1	0 790 73	Alu
1	0 788 74	<b>For 4 x 4 modules</b> White
1	0 790 74	Alu
		<b>Surface-mounting workstation kits</b>
		To be installed with flush or surface-mounting conduits (mini-trunking or trunking) Equipped with: - surface-mounting frames with removable entries (top/bottom and sides), pre-cut for 40 x 20 mini-trunking - 4-module individual supports for tool-less installation of Mosaic Programme mechanisms (2 optional screws supplied) - removable spacer for integration of 1-gang mechanisms - separation partition for high currents and low currents
1	0 788 82	<b>For 2 x 4 modules</b> White
1	0 790 82	Alu
1	0 788 83	<b>For 3 x 4 modules</b> White
1	0 790 83	Alu
1	0 788 84	<b>For 4 x 4 modules</b> White
1	0 790 84	Alu
		<b>Accessories for installation of modular devices</b>
5	0 801 29	Din-rail type for 2-module modular device 17.5 mm
1	0 788 40	Cover plate for 2-module modular device 17.5 mm With removable transparent protection cap, 4 modules

# Mosaic™ Programme plates



Selection chart for boxes, supports and plates **p. 804-805**

Pack	Cat.Nos	Plates
10 5	0 788 01 0 790 01	<b>For 1 module</b> ○ White - Clips onto support Cat.No 0 802 50 ● Alu - Clips onto support Cat.No 0 802 50
10 5	0 788 11 0 790 11	○ White - 80 x 80 mm. Clips onto supports Cat.Nos 0 802 51/60/61/62/69 ● Alu - 80 x 80 mm. Clips onto supports Cat.Nos 0 802 51/60/61/62/69
10 10 10 5	0 788 02 0 790 02 0 787 22 0 788 80	<b>For 2 modules</b> Clips onto supports Cat.Nos 0 802 51/60/61/62/69 ○ White ● Alu ○ White antimicrobial ○ White antibacterial. IP44 weatherproof Equipped with a membrane which can receive Mosaic™ Programme control and connection functions (cannot be mounted on surface-mounting boxes)
10 5	0 788 03 0 790 03	<b>For 3 modules</b> Clips onto support Cat.No 0 802 59 ○ White ● Alu
10 5 10	0 788 14 0 790 14 0 787 24	<b>For 4 horizontal modules</b> Clips onto supports Cat.Nos 0 802 52/58 ○ White ● Alu ○ White antimicrobial
10 5	0 788 15 0 790 15	<b>For 5 horizontal modules</b> Clips onto supports Cat.Nos 0 802 52/58 ○ White ● Alu
10 5	0 788 25 0 790 25	<b>For 5 vertical modules</b> Clips onto supports Cat.Nos 0 802 52/57 ○ White ● Alu
10 5 10	0 788 04 0 790 04 0 787 25	<b>For 2 x 2 horizontal modules</b> Clips onto supports Cat.Nos 0 802 52/57 or 2 x 802 51 ○ White ● Alu ○ White antimicrobial

Pack	Cat.Nos	Plates (continued)
10 5 10	0 788 22 0 790 22 0 787 23	<b>For 2 x 2 vertical modules</b> Clips onto supports Cat.Nos 0 802 52/57 or 2 x 0 802 51 ○ White ● Alu ○ White antimicrobial
10 5 10	0 788 16 0 790 16 0 787 26	<b>For 6 horizontal modules</b> Clips onto supports Cat.No 0 802 53 ○ White ● Alu ○ White antimicrobial
10 5	0 788 18 0 790 18	<b>For 8 horizontal modules</b> Clips onto support Cat.Nos 0 802 53 or 3 x 0 802 51 ○ White ● Alu
10 5	0 788 06 0 790 06	<b>For 3 x 2 horizontal modules</b> Clips onto support Cat.Nos 0 802 53 or 3 x 0 802 51 ○ White ● Alu
10 5	0 788 23 0 790 23	<b>For 3 x 2 vertical modules</b> Clips onto support Cat.Nos 0 802 53 or 3 x 0 802 51 ○ White ● Alu
2 1	0 788 10 0 790 10	<b>For 10 vertical modules</b> Clips onto supports Cat.No 0 802 54 ○ White ● Alu



# Mosaic™ Programme plates (continued)

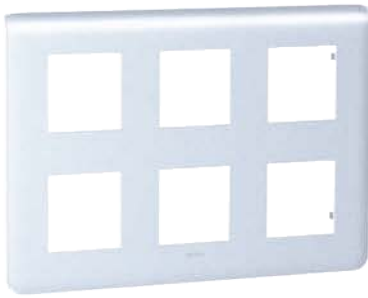

0 790 32











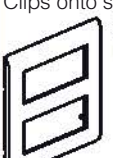

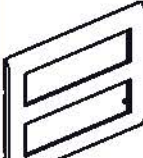
0 788 64

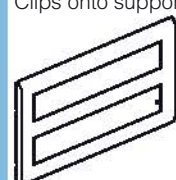

0 788 56

Selection chart for boxes, supports and plates p. 804-805

Pack	Cat.Nos	Plates (continued)
2 1	0 788 08 0 790 08	<b>For 4 x 2 horizontal modules</b> Clips onto supports Cat.Nos 0 802 54 or 3 x 0 802 51  ○ White ● Alu
5 1	0 788 30 0 790 30	<b>For 2 x 5 modules</b> Clips onto support Cat.No 0 802 64  ○ White ● Alu
5 1	0 788 38 0 790 38	<b>For 2 x 2 x 2 modules</b> Clips onto support Cat.No 0 802 64  ○ White ● Alu
5 1	0 788 36 0 790 36	<b>For 2 x 6 modules</b> Clips onto support Cat.No 0 802 66  ○ White ● Alu
5 1	0 788 37 0 790 37	<b>For 2 x 8 modules</b> Clips onto support Cat.No 0 802 64  ○ White ● Alu

Pack	Cat.Nos	Plates (continued)
5 1	0 788 32 0 790 32	<b>For 2 x 3 x 2 modules</b> Clips onto support Cat.No 0 802 66  ○ White ● Alu
1 1	0 788 28 0 790 28	<b>For 2 x 10 modules</b> Clips onto support Cat.No 0 802 66  ○ White ● Alu
10	0 788 64	<b>Special plates for installations with special flush-mounting boxes</b> For installing Mosaic functions in old flush-mounting boxes with 57 mm spacing White  For 2 x 2 horizontal modules
10	0 788 66	 For 3 x 2 horizontal modules
10	0 788 54	 For 2 x 2 vertical modules
10	0 788 56	 For 3 x 2 vertical modules
10 10	0 791 51 0 791 52	<b>Label holders</b> Holders for self-adhesive labels for Mosaic finishing plates or any other Mosaic installation support  Curved transparent label holder  Flat transparent label holder

Workstation kits,  
p. 805



# Mosaic™ Programme supports



Selection chart for boxes, supports and plates **p. 804-805**

Pack	Cat.Nos	Supports with site protection
10	0 802 50	For 1 module
10	0 802 51	For 2 modules
10	0 802 61	For 2 modules with clips or claws (length 27 mm)
10	0 802 69	For 2 modules with long clips (length 37 mm)
5	0 802 59	For 3 modules
10	0 802 52	For 4, 5 or 2 x 2 modules, horizontal or vertical
5	0 802 53	For 6, 8 or 3 x 2 modules horizontal or vertical
5	0 802 54	For 10 or 4 x 2 modules
5	0 802 64	For 2 x 4 or 2 x 2 x 2 modules Without site protection
5	0 802 66	For 2 x 6, 2 x 8 or 2 x 3 x 2 modules Without site protection
5	0 802 68	For 2 x 10 modules Without site protection

Pack	Cat.Nos	Blanking plates for Batibox supports
10	0 791 04	For supports Cat.Nos 0 802 52/58/64 4 modules
10	0 791 06	For supports Cat.Nos 0 802 53/66 6 modules
10	0 791 10	For supports Cat.Nos 0 802 54 10 modules

Pack	Cat.Nos	Other supports for Italian type boxes supplied with screws
10	0 802 13	3 modules
5	0 802 14	4 modules
5	0 802 16	6 modules

Pack	Cat.Nos	Illuminated supports
1	0 802 60	For 2 modules Power: 0.03 W Ideal for illumination function
1	0 802 62	For 2 modules Power: 1.4 W Ideal for indicator function
1	0 802 57	For 5 or 2 x 2 vertical modules Power: 0.03 W Illumination function
1	0 802 58	For 4, 5 or 2 x 2 horizontal modules Power: 0.03 W Illumination function

Pack	Cat.Nos	Thin wall supports
10	0 802 90	<b>Narrow 1 module</b> For mounting on box Cat.No 0 800 10 ○ White ● Alu
10	0 802 94	
10	0 802 91	<b>Narrow 2 modules</b> For mounting on 1 box Cat.No 0 800 11 ○ White ● Alu
10	0 802 95	
10	0 802 92	<b>Narrow 2 x 1 module, vertical</b> ○ White ● Alu For mounting on 2 boxes Cat.No 0 800 10

## Mosaic™ Programme call units

for day hospitals, dialysis centres...



Selection chart for plates **p. 806**  
Supports **see opposite**

Suitable for hotels, schools, non-medical residential homes  
For centralisation of 1 to 6 calls via indicator lights  
Call control via pushbutton  
2 wires per direction  
Registration of calls via numbered indicator lights and brief audible signal  
Several calls can be registered simultaneously  
Individual cancelling for each direction  
Supplied with numbers  
Possibility of using a 12 V protected supply for 12 V SELV units

Pack	Cat.Nos	Equipped call units
1	0 766 63	Supplied with support frame and white finish plate Surface or flush-mounting 2 modules Call unit equipped with : - a 12 mm spacing socket for plugging component or biomedical alarm - a 2-module plate with a blanking plate
1	0 766 64	Bathroom call unit equipped with pull-cord pushbutton and LED indicator
<b>Call units to be equipped</b>		
1	0 766 55	6-direction modules Used to create call panels according to requirements 6 modules With integrated power supply 127/230 V~ - 50/60 Hz
1	0 766 57	For external 12 V SELV power supply (not provided)
<b>6-direction transfer unit</b>		
1	0 766 56	6 directions For remote transfer of calls 6 modules
<b>Component for call unit</b>		
10	0 783 62	NO/NC contact - 2 A Equipped with cord, length 2 m With 12 mm fixed-pitch for 2P socket Cat.No 0 771 50
<b>Socket outlet</b>		
10	0 771 50	2P ELV screw terminals Automatic terminals - Antimicrobial 1 module

Selection guide,  
**see e-catalogue**

Wiring diagram,  
**see e-catalogue**

## Mosaic™ Programme nurse call units

for day hospitals, dialysis centres...



Designed for nurse call equipment in day hospitals, dialysis and transfusion centres, scanners, etc.

Functions:  
• from the room: calls, emergency calls, nurse present indicator and call cancelling  
• from the nurses' station: patient reassurance  
Possibility of adding a paging system

Pack	Cat.Nos	Display units and management
1	0 766 60	<b>6-direction call display unit</b> Registration of calls via numbered indicator lights and audible signal Several calls can be registered simultaneously Display of reassurance indicator and nurse present Possibility of transferring calls to 4 other display units (e.g.: treatment room, rest area, etc.) Installed: - in surface mounting box Cat.No 0 802 86 - on table control unit Cat.No 0 782 14 6 modules
1	0 782 14	<b>Table control unit</b> Takes up to 6 display units Cat.No 0 766 60 Horizontal or vertical mounting Dim.: 310 x 295 x 75 mm 36 modules
1	0 782 89	<b>24 V - 2 A - 48 W power supply</b> Powers the system If necessary, a 24 V protected power supply can be used 8 modules
1	0 782 12	<b>3-direction management module</b> Manages 3 rooms (or directions) Possibility of forwarding via NO volt-free contact for indicator, audible signal, paging, master indicator 4 modules
<b>Corridor and room equipment</b>		
1	0 766 72	Supplied with metal support for screw mounting and white finishing plate 2 modules Can be flush or surface mounting Fitted with long life LEDs <b>Double display corridor overdoor light unit</b> Double indicator (red/white) Displays calls and nurse present in the corridor
1	0 782 04	<b>Door unit</b> Includes 1 red indicator, 1 white indicator and 1 call and nurse presence cancel pushbutton. Antimicrobial

Selection guide for drawing up a list of equipment,  
**see e-catalogue**

# Nurse call units

call devices for rooms and bathrooms

Compatible with all  
Legrand nurse call systems



Technical characteristics **see e-catalogue**

Parts used for calling a nurse  
Information report on door unit and control unit for nurses' station  
Compatible with all Legrand nurse call systems

Pack	Cat.Nos	Call units for rooms	Antimicrobial: hand-held remote control unit and cord	Pack	Cat.Nos	Call units for bathrooms
1	0 782 40	<p>White antimicrobial Magnetic connection between hand-held remote control unit and socket Can be ejected in all directions with pull-out torque designed to avoid any damage to the equipment</p> <p><b>Hand-held remote control unit for call only</b> IP 67 waterproof hand-held remote control unit: - designed ergonomically for ease of handling - 1 call button and red indicator for call confirmation - visible at night via 2 illuminated LEDs Fitted with a 2.5 m cord For use in conjunction with socket Cat.No 0 782 41</p>		1	0 782 48	<p>White antimicrobial Mechanisms supplied with support and finishing plate</p> <p><b>Ejectable call pull cord</b> Bathroom call pull cord, IP 55 waterproof, ejectable With red indicator for call confirmation Fitted with height-adjustable handle Red antimicrobial cord Can be installed in a shower at a height of 2.20 m</p>
6	0 782 42	<p><b>Call and lighting control hand-held remote control unit</b> IP 67 waterproof hand-held remote control unit: - designed ergonomically for ease of handling - 1 call button and red indicator for call confirmation - visible at night via 2 illuminated LEDs - 1 button for reading light control - 1 button for room light control Fitted with a 2.5 m cord For use in conjunction with socket Cat.No 0 782 45</p>		1	0 766 85	<p><b>Call unit</b> Antimicrobial bathroom call pushbutton With red indicator for call confirmation IP 20 IP 44 with plate Cat.No 0 788 80 (p. 806)</p>
6	0 782 44	<p><b>Hand-held control unit for calls and controlling lighting and roller shutters</b> IP 67 waterproof hand-held remote control unit: - designed ergonomically for ease of handling - 1 call button and red indicator for call confirmation - visible at night via 2 illuminated LEDs - 1 button for reading light control - 1 button for room light control - 2 buttons for controlling roller shutters - 1 free function button (example: switched socket) Fitted with a 2.5 m cord For use in conjunction with socket Cat.No 0 782 45</p>		1	0 782 49	<p><b>Call units for specific environments</b></p> <p><b>Waterproof call unit - Plexo 55 finish</b> IP 55 Mechanism supplied with support and finishing plate in white With red indicator for call confirmation Suitable for damp environments (e.g.: rehabilitation and recovery centres with swimming pool, steam room, sauna, etc.)</p>
4	0 782 46	<p><b>Sockets for hand-held remote control units</b> Supplied pre-assembled with finishing plate in white, antimicrobial and 2-module support</p> <p>Non-indexed magnetic connection socket for hand-held remote control unit Cat.No 782 40</p>		1	0 782 51	<p><b>High-resistance call unit - Soliroc finish</b> Call unit with high resistance to impacts IK 10 and to humidity IP X5 Grey metallic alloy With red indicator for call confirmation Suitable for psychiatric and penal institutions, etc. Supplied pre-assembled with plate and support</p>
4	0 782 47	<p>Magnetic connection socket for hand-held remote control units Cat.Nos 0 782 42/44</p>		1	0 771 50	<p><b>Biomedical call units for bedrooms or special rooms</b> 1 module</p> <p><b>Socket mechanism for biomedical calls</b> Signals the end of a cycle via an alarm on the nurse call unit system For connecting portable electrical medical appliances such as syringe pumps, respirators, etc.</p> <p>12 mm fixing centres ○ White antimicrobial</p>
5	0 782 43	<p><b>Accessory for hand-held remote control units</b> Clamp for holding the hand-held remote control unit within reach: on beds, clothes, armchairs, edge of beds, etc.</p>		1	0 782 07	<p><b>Shunt plug</b> Shunt plug for biomedical alarm standby 12 mm fixing centre Used with socket Cat.No 0 771 50</p>

## Control units for bedhead strips



0 783 75 / 0 766 77

Magnetic connection between  
0 782 40 and 0 782 41

0 782 45

Pack	Cat.Nos	Lighting control units
1	0 783 75	1 module 230 V - 2 A White antimicrobial Grey antimicrobial cord Two-way switch with ejectable pull cord
1	0 766 77	Pull-cord switch with ejectable pull cord
1	0 783 76	Pushbutton with ejectable pull cord
<b>230 V ~ remote control modules</b>		
Boxes for controlling lighting or other SELV functions via hand-held remote control units For mounting in the bedhead strips Connected via screw terminals		
1	0 783 77	Used to control 4 lighting circuits (for example: room, reading, nursing, standby, etc.) Compatible with hand-held remote control unit Cat.No 0 782 42 (p. 810) Dimensions: 230 x 71 x 44 mm
1	0 783 78	Used for controlling 2 lighting outputs (room and reading) as well as the roller shutters (up, down) and 1 x 16 A all-function outlet Compatible with hand-held remote control unit Cat.No 0 782 44 (p. 810) Dimensions: 230 x 71 x 44 mm
1	0 783 79	Used for controlling 2 lighting outputs (room with dimming light and reading) with level storage, roller shutters (up, down) and 1 x 16 A all-function outlet Compatible with hand-held remote control unit Cat.No 0 782 44 (p. 810) Dimensions: 230 x 71 x 44 mm
<b>2-module socket mechanisms for hand-held remote control unit</b>		
1	0 782 41	Socket for hand-held remote control unit for call only Magnetic connection without locating device for hand-held remote control unit Cat.No 0 782 40 (p. 810) White antimicrobial
1	0 782 45	Socket for hand-held remote control units Magnetic connection for hand-held remote control units Cat.Nos 0 782 42/44 (p. 810) White antimicrobial

## THE MOSAIC™ ECOCOMFORT ROOM



# Comfort, safety and **energy** performance

The Legrand ecomcomfort room fulfils three important criteria for retirement homes and healthcare buildings: resident/patient safety, healthcare staff efficiency and energy performance.



### ■ LED bedhead strips

Antimicrobial treatment.  
Room and reading lighting, dynamic lighting.

### ■ Easy to use, innovative controls

Antimicrobial magnetic hand-held remote control unit: ejectable without extraction.  
Lighting for assistance with independent living.  
Nurse call device.

### ■ Actimetry devices

Wristband, software, etc. for residents' safety and efficiency of the healthcare staff.

## BUS/SCS nurse call unit

signalling and acknowledgement units for rooms Antimicrobial



0 766 06



0 766 07



0 766 08



0 782 00

Technical characteristics [see e-catalogue](#)

BUS/SCS system with star wiring around the door unit:

- call centralisation
- acknowledgement
- communication with nursing control unit and all elements of the system via BUS/SCS
- signalling forwarded to all indicators (e.g.: corridor overhead light unit, door unit, hand-held remote control unit)

Pack	Cat.Nos	Antimicrobial door units for rooms
1	0 766 06	For installation at the entrance to the room, can be seen from the bed Connect directly to the BUS/SCS cable Cat.Nos 0 492 32/33 With indicator and pushbutton for calls, nurse presence and 2nd nurse presence Comply with standards VDE 0834-1 and 0834-2 Fault display 4-module wiring mechanisms supplied complete Flush mounting in 50 mm deep box or surface mounting with frame Cat.No 0 766 14 (p. 813) <b>Door unit with indicators</b> Door unit with illuminated call indicators Nurse presence and acknowledgement via pushbutton. Audible and illuminated signal of a call coming from another room. Suitable for shared bathrooms and for secure wandering
1	0 766 07	<b>Door unit with display</b> Door unit with alphanumerical display. Nurse presence and acknowledgement via pushbutton. Call display from another room. Used in conjunction with the interphone unit Cat.No 0 766 09 for communicating with rooms issuing calls and with a nurse present. User is able to acknowledge at the end of the communication
1	0 782 19	<b>Bed extension</b> To be associated with Cat.No 0 766 06 or 0 766 07 Allows the connection of 4 components to 1 call unit DIN, 6 modules. Programming via virtual configuration

1	0 766 08	<b>Antimicrobial interphone unit for room and nurses' station</b> <b>Interphone door unit</b> For installation: - at the entrance to the room connected to the door unit with display Cat.No 0 766 07 - in the nurses' room linked to the control unit Cat.No 0 766 11 (p. 813) Allows the user to: - communicate from one room to another room issuing a call or with a nurse present - broadcast a general call Must be connected to a microphone Cat.No 0 782 00 for communication between the patient and the nursing staff 4-module wiring mechanism supplied complete Flush mounting for Mosaic in 50 mm deep box or surface mounting with frame Cat.No 0 766 14 (p. 813)
1	0 782 00	<b>Room microphone</b> Remote microphone for connection to the interphone unit Cat.No 0 766 08 For installation next to the bed. For communication between the patient and the nursing staff. 2-module mechanism. Supplied pre-assembled with finishing plate in white and 2-module support

## BUS/SCS nurse call unit

corridor signalling units



0 766 70



0 766 04

Technical characteristics [p. 818](#)

Ensures that information is transferred into the corridor

Pack	Cat.Nos	Corridor signalling devices
1	0 766 71	For installation in the corridor above the doors Supplied with support and white finishing plate Flush-mounting or surface-mounting. <b>Call only overdoor light unit for corridors</b> LED triangular overdoor light unit for call signalling 1 red indicator For call signalling 2 modules
1	0 766 70	<b>Call and nurse presence overdoor light units for corridors</b> LED triangular overdoor light units for call signalling, bathroom calls and nurse presence Monobloc indicator in red, white, green 2 modules Recommended for compliance with standards VDE 0834-1 and 0834-2
1	0 766 04	<b>Corridor display unit</b> For installation in the corridor 10-character alphanumeric display Indication of calls and nurse presence by level of priority For fixing in false ceiling or on the wall Supplied with connection interface to the BUS/SCS
1	0 766 05	Double sided display unit
1	0 766 03	<b>Fixing accessory for corridor display unit</b> For fixing a corridor display unit projecting

Wiring diagram example, [see e-catalogue](#)



# BUS/SCS nurse call unit

signalling units for nurses' station

Antimicrobial



0 766 18 Traceability software



0 035 44

Technical characteristics **see e-catalogue**

Pack	Cat.Nos	Antimicrobial control units
1	0 766 11	<p>Call and presence display for all bedrooms and rooms in order of priority (max. 150) 4-module wiring mechanism supplied with support Installation in 50 mm deep flush-mounting box or on inclined plane Cat.No 0 766 12/13 with alphanumeric display and adjustable audible signal Scrolled display of the calls and nurse visits in progress Fitted with a malfunction indicator Used in conjunction with the interphone unit Cat.No 0 766 08 allows:</p> <ul style="list-style-type: none"> <li>- communication with the bedrooms issuing calls and with a nurse present</li> <li>- call acknowledgement at communication end</li> <li>- calls to be made to all rooms with a nurse present</li> </ul> <p>Connects directly to the BUS/SCS cable Cat. Nos 0 492 32/33</p> <p><b>Main control unit</b> For installation in the nurses' station</p> <p><b>Secondary control unit</b> Can be used in addition to the main control unit in another room (break room, dining room, etc.) or in a corridor</p> <p><b>N</b> <b>Main control unit IP/SCS</b> Installation in flush-mounting box (17.5 mm) or on inclined plane Dimensions : - when flush-mounted: 217 x 138 x 46 mm - on inclined plane: 217 x 125 x 90 mm To be used as main control unit, secondary control unit or centralised control unit, depending on setting Possibility to centralise all traceability and DECT events for a whole building on one control unit To be connected to Ethernet network or 27 V external power supply. Connection to BUS SCS cable for communication with door units Cat.Nos 0 766 06 and 0 766 07</p>
1	0 492 32	<b>BUS/SCS cables</b> Supplied on a reel Length 500 m
1	0 492 33	Length 200 m Non-halogen cable
1	0 766 12	<b>Fixing accessories</b> <b>For control units</b> Inclined plane for fixing control unit only onto table
1	0 766 13	Inclined plane for fixing control unit + interphone unit onto table
1	0 766 14	<b>For control units, door units and interphone units</b> Surface mounting frame for refurbishment
1	0 766 19	<b>Call transfer interface to DECT</b> Interface for forwarding information as ESPA 444 protocol to the DECT system (text messages only) 2 x 17.5 mm DIN modules

Pack	Cat.Nos	Traceability on PC
1	0 766 18	<p><b>Traceability software</b> Memorises and categorises events by information type (calls, nurse presence, acknowledgement, etc.) Time stamping of events Export of the elements as .csv files which can be used on a PC Works with traceability interface Cat.No 0 766 17 to be ordered separately</p>
1	0 766 17	<p><b>Traceability interface</b> Works with call traceability software Cat.No 0 766 18 2 x 17.5 mm DIN modules</p>
1	0 035 44	<p><b>Building manager</b> Ensures communication of the Modbus-Bacnet protocols, storing and information history Can be used to centralise the following software packages: - lighting actimetry Cat.No 0 783 80 - traceability Cat.No 0 766 18</p>

Wiring diagram example, **see e-catalogue**



More information in our "Solutions for retirement homes & healthcare establishments" brochure available on [www.docexport.legrand.com](http://www.docexport.legrand.com)



# BUS/SCS nurse call unit

system products



0 035 60



0 782 90



0 766 10



0 261 45

Pack	Cat.Nos	<b>SELV power supplies</b>
1	0 035 60	<b>For BUS/SCS</b> Secure power supply 230 V~ - 27 V= - 1.2 A 17.5 mm 8 modules DIN
1	0 634 35	<b>For sound system</b> Power supply unit Input voltage: 230 V~ Output voltage: 27 V= Maximum consumption: 1 A 8 DIN modules
1	0 782 90	<b>For indicators</b> For overdoor light units with bulb or LED 230 V/24 V - 2.5 A power supply For mounting in modular cabinets 6 modules
1	0 766 10	<b>BUS/SCS extension</b> For communicating information between 2 BUS/SCS nurse call systems Used where departments are grouped together or for departments with more than 80 rooms (e.g.: nursing homes, residential homes for the elderly, etc.)

Pack	Cat.Nos	<b>Physical configuration of the installation</b>
		Suitable for establishments with fewer than 80 rooms
		<b>Configuration using a configurator</b> Used to associate an address with the different system components Kit with configurators 0 to 9 (10 configurators for each digit) ↑↓ - symbol
1	0 261 45	
5	0 492 20	
		<b>Virtual configuration of the installation</b> Recommended for installations above 80 rooms
		<b>Configuration via PC</b> Virtual configuration software For installations of 0 to 150 departments For use with interface Cat.No 0 766 16 (to be ordered separately) for connecting a PC
1	0 766 15	
		<b>Configuration kit</b> Interface for connecting a PC and the installation Works with software Cat.No 0 766 15
1	0 766 16	





# BUS/SCS nurse call unit

## secure wandering device



Pack	Cat.Nos	Secure wandering device
		Indicates that a door has been crossed by the resident wearing the device Works with door unit Cat.No 0 766 06 configured for secure wandering and allowing acknowledgement Simultaneous alarm transmission over DECT
1	0 766 20	<b>Ring</b> Fitted with 869 MHz radio transmitter Anti-allergy White Permanent fixing
1	0 766 21	<b>Aerial</b> Receives the ring signal and transmits it to the controller
1	0 766 22	<b>Door controller</b> Coded keypad for capturing the ring's signal when a certain door has been crossed Works with aerial Cat.No 0 766 21
1	0 766 06	<b>Door unit</b> With illuminated escape indicator Acknowledgement via pushbutton
10	0 431 00	<b>Magnetic opening detector</b> Surface-mounted magnetic detector 1 spring blade switch to be fixed on the door frame 1 moving magnet to be fixed on the door leaf
		<b>Electric door release</b>
1	0 408 98	Shunt trip door release 12 V~/ = 6 W - 158 x 26 x 32 mm - 500 mA
1	0 408 96	Very short shunt trip door release (2-stage) 12 V= - 200 mA For operation in double-entrance security doors Dimensions: 158 x 26 x 32 mm
1	0 408 95	Undervoltage door release 12 V= - 600 mA For operation in emergency exits Dimensions: 158 x 26 x 32 mm
		<b>Motorised bolt</b>
1	0 767 09	Motorised bolt with manual internal unlocking Built-in position contact 12 V= - 410 mA For surface-mounting installation

Pack	Cat.Nos	Electromagnetic locks												
1	0 767 07	<b>Electromagnetic lock 300 kg</b> Signalling of the leaf position via 2-colour LED and forwarding possible by changeover switch Control of the door position by Hall effect (not compatible with operation of the local emergency exit management unit Cat.No 0 380 57) Consumption: 24 V 300 mA 7.2 W, 12 V 600 mA 7.2 W												
1	0 767 08	<b>Electromagnetic lock 500 kg</b> Signalling of the leaf position via 2-colour LED and forwarding possible by changeover switch Control of the door position by Hall effect (not compatible with operation of the local emergency exit management unit Cat.No 0 380 57) Consumption: 24 V 250 mA 7.2 W, 12 V 500 mA 7.2 W												
		<b>Protected power supply</b>												
1	0 767 18	12 V power supply = - 4 A. Backed up by 12 V - 7 Ah battery Cat.No 0 407 49 (not supplied)												
		<b>Filtered rectified power supply</b>												
		Comprising: - a safety transformer with interference filtering - a filter capacitor - protection by PTC integrated in the primary - double operating terminals PTC: Positive temperature coefficient. In the event of an automatic cut-off due to an overload or short circuit, switches off the power supply and allows it to cool down before switching on again.												
1	4 131 05	<b>12 V=</b>												
		<table border="1"> <thead> <tr> <th rowspan="2">Power (W)</th> <th rowspan="2">Current (A)</th> <th colspan="2">Terminal capacity flexible cables (mm<sup>2</sup>)</th> <th rowspan="2">No. of modules</th> </tr> <tr> <th>input</th> <th>output</th> </tr> </thead> <tbody> <tr> <td>15</td> <td>1.3</td> <td>6</td> <td>6</td> <td>5</td> </tr> </tbody> </table>	Power (W)	Current (A)	Terminal capacity flexible cables (mm <sup>2</sup> )		No. of modules	input	output	15	1.3	6	6	5
Power (W)	Current (A)	Terminal capacity flexible cables (mm <sup>2</sup> )			No. of modules									
		input	output											
15	1.3	6	6	5										

# Mosaic™ Programme antimicrobial snap-on trunking 50 x 80 and 50 x 130

## Cat.Nos for trunking 50 x 80



## Cat.Nos for trunking 50 x 130



Conform to ISO 22196

### Pack Cat.Nos 50 x 80 snap-on trunking

20'	<b>50 x 80</b> 0 757 00	<b>1-compartment trunking</b> Can take any Mosaic or Arteor wiring accessory Includes: - 1 body - 1 cover, width 45 mm Length: 2 m
-----	----------------------------	---

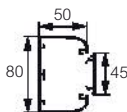

### Angles for 50 x 80 trunking

10	0 757 10	Internal angle, varies from 80° to 100°
10	0 757 15	External angle, varies from 85° to 120°
10	0 757 20	Flat angle at 90°

### End cap for 50 x 80 trunking

10	0 757 05	Left or right end cap
----	----------	-----------------------

### Pack Cat.Nos 50 x 130 snap-on trunking

12'	<b>50 x 130</b> 0 757 02	<b>2-compartment trunking</b> Can take any Mosaic or Arteor wiring accessory Includes: - 1 body with 2 compartments - 2 covers, width 45 mm Length: 2 m
-----	-----------------------------	--

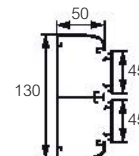

### Angles for 50 x 130 trunking

5	0 757 12	Internal angle, varies from 80° to 100°
5	0 757 17	External angle, varies from 85° to 120°
5	0 757 22	Flat angle at 90°

### End cap for 50 x 130 trunking

5	0 757 07	Left or right end cap
---	----------	-----------------------

1: Number of metres in pack

## Mosaic™ Programme antimicrobial snap-on trunking 50 x 180

## Mosaic™ Programme accessories for antimicrobial snap-on trunking

Cat.Nos for trunking 50 x 180



Cat.Nos for trunking 50 x 180

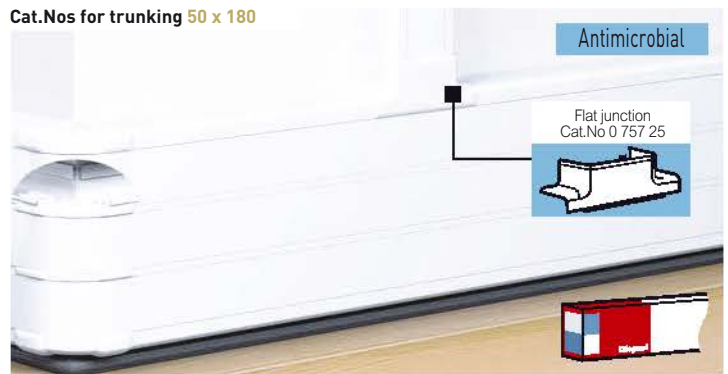

Conform to ISO 22196

Pack	Cat.Nos	50 x 180 snap-on trunking
8'	50 x 180 0 757 04	<b>3-compartment trunking</b> Can take any Mosaic or Arteor wiring accessory Includes: - 1 body with 3 compartments - 3 cover, width 45 mm Length: 2 m
5	0 757 14	<b>Angles for 50 x 180 trunking</b> Internal angle, varies from 80° to 100°
5	0 757 19	External angle, varies from 85° to 120°
5	0 757 24	Flat angle at 90°
5	0 757 09	<b>End cap for 50 x 180 trunking</b> Left or right end cap

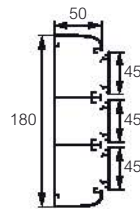

Pack	Cat.Nos	Flat junction
5	0 757 25	With 80, 130 and 180 mm wide sections Creates a junction with snap-on trunking 50 x 80 mm
20'	0 757 29	<b>Extra cover</b> Width 45 mm Length 2 m
26'	0 756 09	<b>Extra partition</b> Divider Length 2 m
20	0 757 30	<b>Joint</b> Stick-on body joint
10	0 757 35	<b>Cover joint</b> Width 45 mm
10	0 757 36	<b>Soluclip accessory</b> For installation of maximum two 45 x 45 mm Mosaic antimicrobial mechanisms

1: Number of metres in pack





## Bedhead strips:

### Self-extinguishing test

The test report related to compliance with the fire safety regulations is completed by an independent organisation

It involves a self-extinguishing test following application of an incandescent wire to the luminaire

The luminaire is qualified in accordance with the temperature of the wire applied and the time taken for the flame to extinguish: 850° and 30 seconds maximum are the qualification criteria for public buildings

### CE marking

CE marking is a mandatory marking for luminaires

It is a declaration from the manufacturer itself which commits its signatory alone. There is no verification by external organisations

It is based on specific directives and standards which govern the manufacture of luminaires from the point of view of safety and electromagnetic compatibility

For electrical safety it involves standard EN 60 598 known as the Luminaire Standard

It ensures that the assemblies are electrically compliant and in a broader sense ensures all electrical safety aspects for the user

Standard EN 60 598-2-25 is specific to luminaires in hospitals and health establishments

In terms of electromagnetic compatibility several standards provide a reference for luminaires

The aim is to ensure that the luminaire in operation is not going to disrupt other electrical and/or electronic devices such as televisions, alarms and indeed pacemakers

Conversely it must be ensured that these electrical or electronic devices do not disrupt the operation of the luminaires (for example their switching on):

- EN 12464-1 and NFX 90-003-1 standards on luminaires and the lighting of indoor workplaces
- EN 61547 CE standard on luminaire immunity
- EN 55015 CE standard on luminaire radiation
- EN 61000-3-2 CE standard on luminaire harmonics

### Trunking for medical gases

Extract of standard FD S 90\_155 on distribution systems for medical gases: where so-called "bedhead" medical gases are installed (see EN ISO 11197 on service ducts) or fixed mast arms (or ceiling columns) fitted in particular with sockets for medical gases, it is recommended that the same manufacturer is used for the distribution system and for the busbar systems inside the trunking, including the medical gas sockets integrated into the supplies provided

## BUS/SCS nurse call unit

Complies with the VDE standard on call systems for hospitals, nursing homes and similar establishments:

- DIN VDE 0834-1 instructions for equipment, its installation and operation
- DIN VDE 0834-2 environmental conditions and electromagnetic compatibility

The indicators associated with the hospital signalling conform with the general standard EN 60 073 which provides the colour coding principles



Perfectly suitable for retirement homes, establishments providing a low level of medical care and homes

Pack	Cat.Nos	LED bedhead strips
		Very low consumption LED lighting with an estimated lifetime of 100,000 hours IP 20 - IK 04 Alu material, grey, antimicrobial Resistance to incandescent wire: 850 °C Class I Ra or TCl: 80 Colour T°: 6,500 °K Comply with standards EN 60598-1, EN 60598-2-25, EN 12464-1
		<b>LED reading lighting</b>
1	0 783 30	Bedhead strip with remote control for reading Strip length: 0.97m
1	0 783 31	Bedhead strip fitted with an antimicrobial pull cord switch Modular: 3 modules on one side and 4 antimicrobial Mosaic modules on the other side of the strip Compatible with BUS/SCS nurse call unit (p. 812): Can be fitted with a remote control socket Strip length: 1.40 m
		<b>Reading and room lighting</b>
		Compatible with BUS/SCS nurse call unit (p. 812): Can be fitted with a socket for hand-held remote control unit
1	0 783 29	Bedhead strip with remote control for reading and room lighting Strip length: 0.97m
1	0 783 32	Extendable bedhead strip: 4 antimicrobial Mosaic modules on each side of the strip Strip length: 1.40 m
1	0 783 87	Bedhead strip fitted with antimicrobial Mosaic mechanisms: - 1 blanking plate 2 modules - 1 two-way switch for room lighting - 1 pull cord switch for reading - 2 x 2P+E sockets - German standard Strip length: 1.40 m

# Bedhead strips

for non-medical establishments (continued)

Antimicrobial



0 783 36



0 783 42  
Room lighting  
with dimming

Technical characteristics **see opposite**

Perfectly suitable for retirement homes, establishments providing a low level of medical care and homes

Pack	Cat.Nos	LED bedhead strip with dynamic lighting
1	0 783 36	<p>Very low consumption LED lighting with an estimated lifetime of 100,000 hours IP 20 - IK 04 Aluminium material, grey, antimicrobial Resistance to incandescent wire: 850 °C Class I Ra or CRI: 80 Colour T° = 2,500 to 6,500 °K Complies with standards EN 60598-1, EN 60598-2-25, EN 12464-1</p> <p><b>LED dynamic reading and room lighting</b> For automatic management of the lighting colour depending on the time of day so as to reduce cognitive deficiencies Fitted with light level cell for automatic adjustment of the light intensity in accordance with the natural light level</p> <p>Bedhead strip fitted with antimicrobial Mosaic mechanisms: - 1 blanking plate 2 modules and 1 blanking plate 1 module - 1 pull cord switch for reading - 2 x 2P+E sockets - German standard Compatible with BUS/SCS nurse call unit (p. 812) Can be fitted with a socket for hand-held remote control units Strip length: 1.40m</p>

White to amber lighting

Pack	Cat.Nos	LED fluorescent bedhead strips
1	0 783 42	<p>IP 20 - IK 04 Alu material, grey, antimicrobial Resistance to incandescent wire: 850 °C Class I Complies with standards EN 60598-1, EN 60598-2-25, EN 12464-1 LED reading lighting Fluorescent T5 tube room lighting with electronic ballast Can be fitted with a socket for hand-held remote control units</p> <p><b>Reading and room lighting with dimming</b> Bedhead strip fitted with antimicrobial Mosaic mechanisms: - 1 blanking plate 2 modules and 1 blanking plate 1 module - 1 pull cord switch for reading - 2 x 2P+E sockets - German standard Room lighting dimming possible via pushbutton, pull cord pushbutton and/or hand-held remote control unit Strip length: 1.47 m</p>

## Bedhead strips

for medical establishments, clinics, hospitals, etc.

Antimicrobial



0 783 45



0 783 85



Example of trunking 0 783 50 with supports for assembling 2 ALS sockets 0 783 51



Magnetic connection socket for hand-held remote control unit



Example of Cat.No 0 785 10 integrated into the bedhead strip

Technical characteristics p. 818

Perfectly suitable for medical environments. Comply with current lighting standards: EN 60598-1, EN 60598-2-25, EN 12464-1  
Separate lighting and gas devices to allow electricians and gas engineers to carry out product maintenance in total safety

Pack	Cat.Nos	Fluorescent T5 bedhead strips	Pack	Cat.Nos	Fluorescent T5 bedhead strips (continued)
		<p>IP 20 - IK 04 Alu material, grey, antimicrobial Lighting via T5 tube with electronic ballast: - 300 lux over the reading area - 100 lux for room lighting Option of adding the standby module Cat. No. 785 10 To be fitted with a remote control module for controlling lighting or roller shutters (p. 821) via hand-held remote control units (p. 810) Allow annual savings to be made for an installation of 80 bedhead strips (equivalent to 2 hospital wards for example), calculation in comparison with use of T8 tube ferromagnetic bedhead strips Resistance to incandescent wire: 850°C Class I Ra or TCl: 80 Colour T°: 4,000 °K Comply with standards EN 60598-1, EN 60598-2-25, EN 12464-1</p>			
1	0 783 45	<p><b>1.20 m bedhead strips</b> Non equipped - extendable Room lighting: 1 x 39 W Reading light: 1 x 24 W Extendable strip: 8 modules</p>	1	0 783 88	<p>Equipped - 2 x 2P+E (x 2) German standard sockets Room lighting: 2 x 28 W Reading light: 1 x 24 W Examination lighting: room + reading + 1 x 24 W 16-module bedhead strip fitted with antimicrobial Mosaic mechanisms: - 1 magnetic socket Cat. No 0 782 45 for call and lighting control hand-held remote control units 2 modules - 1 blanking plate 1 module (x 2) - 1 switch for examination lighting - 1 RJ 45 socket, Cat. 6 FTP to be wired - 1 blanking plate 2 modules</p>
1	0 783 86	<p>Equipped - 2 x 2P+E German standard sockets Room lighting: 2 x 24 W Reading light: 1 x 24 W 8-module bedhead strip fitted with antimicrobial Mosaic mechanisms: - 1 blanking plate 2 modules - 1 two-way switch for room lighting - 1 ejectable pull cord switch for reading</p>	1	0 785 10	<p><b>Standby module for bedhead strip</b> To be installed in skirting trunking or bedhead strip 230 V - 2 modules White antimicrobial</p>
1	0 783 85	<p><b>1.60 m bedhead strips</b> Non equipped - extendable Room lighting: 2 x 39 W Reading light: 1 x 24 W Examination lighting: room + reading + 1 x 24 W Conform to NFX 90-003-1 For examination lighting: 300 lux on the bed Extendable strip: 16 modules</p>	1	0 783 50	<p><b>Trunking for gas sockets</b> Supplied in 3m lengths, adjustable Takes medical gas sockets with supports Cat.Nos 0 783 51/52/53 IP 40 Alu material, grey, antimicrobial Complies with the standards on medical gases FDS-90-155</p>
1	0 783 97	<p>Equipped - 2 x 2P+E German standard sockets Room lighting: 2 x 39 W Reading light: 1 x 24 W Examination lighting: room + reading + 1 x 24 W Complies with standard NFX 90-003-1 for examination lighting: 300 lux on the bed 16-module bedhead strip fitted with antimicrobial Mosaic mechanisms: - 2 blanking plates 2 modules - 1 switch for examination lighting - 1 RJ 45 socket, Cat. 6 FTP to be wired - 1 two-way switch for room lighting - 1 ejectable pull cord switch for reading - 2 blanking plates 2 modules</p>			<p><b>Supports for gas sockets</b> For assembling the gas sockets on trunking Cat.No 0 783 50 Alu material, grey, antimicrobial For assembling ALS socket For assembling DKD socket For assembling Caouet socket</p>

## Made-to-measure bedhead trunking unit

### ■ Separated fluids configuration

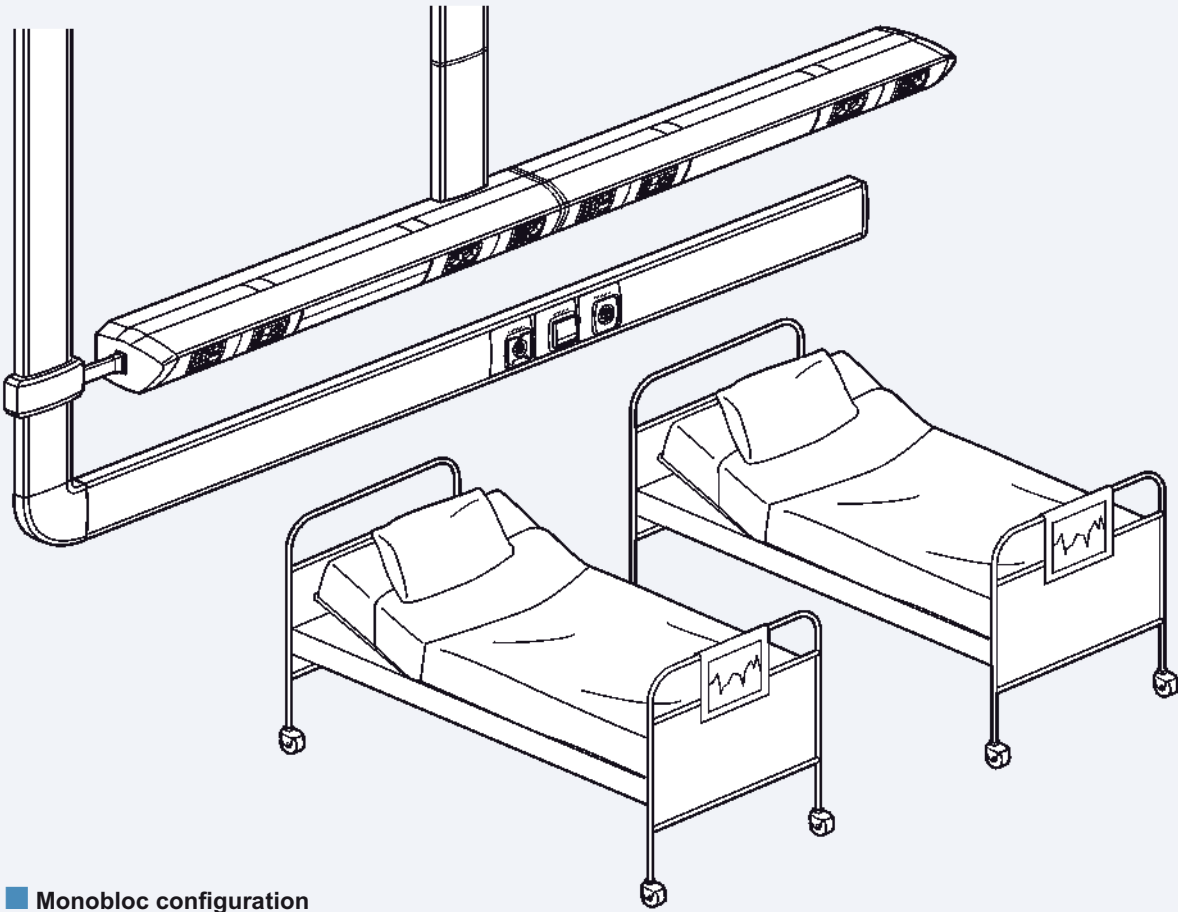

### ■ Monobloc configuration

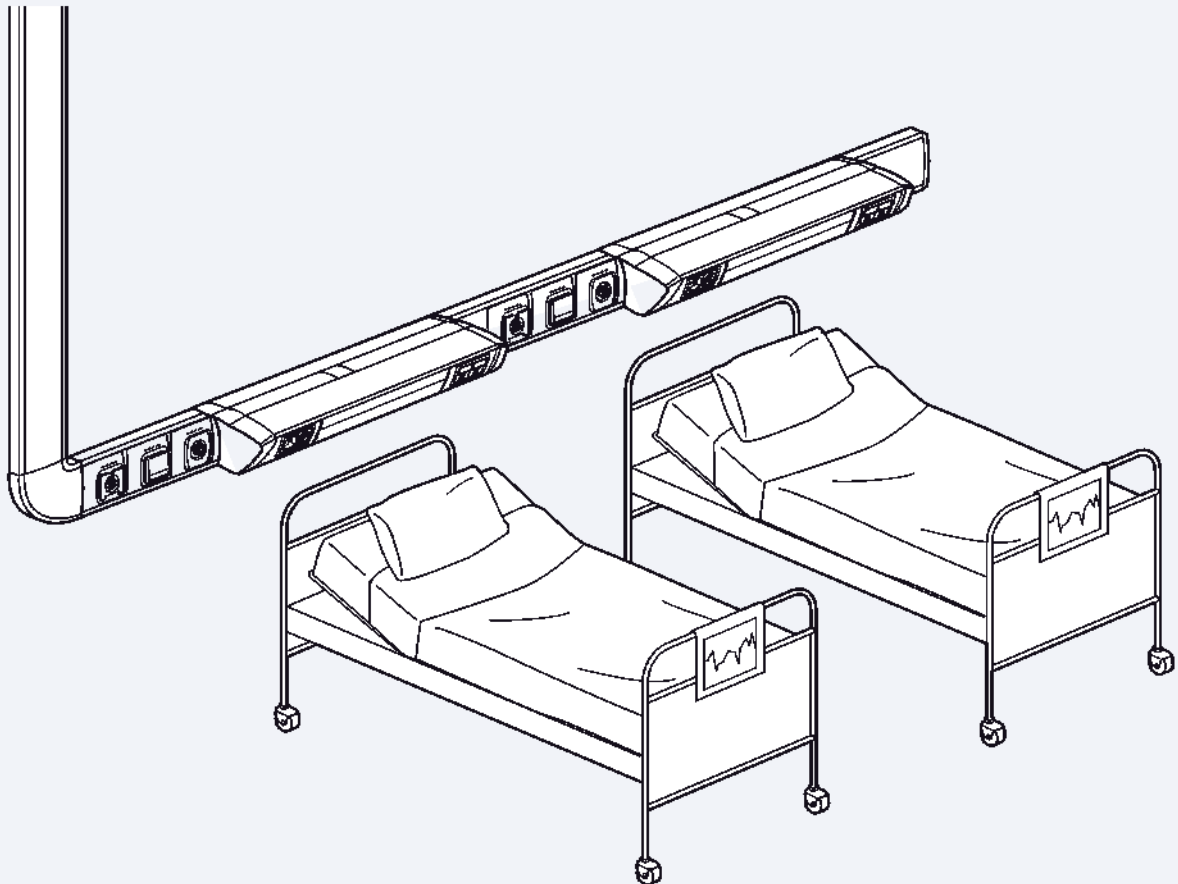





# Lighting to assist with independent living

## stand-alone solutions

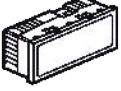

Stand-alone automatic lighting devices which allow the patient to get their bearings and make their way to the bathrooms

Pack	Cat.Nos	For installation in the room	Pack	Cat.Nos	For installation in bathrooms
1	0 784 54	 <p><b>Automatic switch with neutral, 3 wire</b> 2 modules - white For installation at a maximum of 30 cm from the ground in order to pick up the patient's movements once out of bed Allows triggering of the lighting and the illuminated signalling Installing 2 or 3 detectors per room is advisable for optimum movement detection Infrared detection Detection range adjustable from 3m to 10m Horizontal detection angle: 180° Light level threshold adjustable from 3 to 1,000 lux Time delay adjustable from 1s to 16 mins with repetition of cycle as long as movement is detected For installation in box depth 40 mm min. For flush-mounted installation use plate Cat.No 0 788 22 and support Cat.No 0 802 51</p>	1	0 488 06	 <p><b>False ceiling detector switch</b> Connection via automatic terminals • Operating mode: - Vacancy sensing: switched on manually via push-button, switched off automatically via detector or by pressing push-button - Occupancy sensing: switched on and off automatically - Factory pre-set to occupancy sensing mode. Vacancy sensing mode activated by mobile configurators • Light level threshold factory pre-set to 500 lux • Factory pre-set time delay 15 minutes. Walkthrough function activated (short time delay of 3 minutes for 1 walkthrough) • Site adjustment with mobile configurators Cat.Nos 0 882 30/35 • Serial wiring Phase + Neutral + Source With terminals to connect the push-button(s) including push-buttons with LED indicator Cat.Nos 0 770 40/33 • For controlling light sources: - 2,000 W max 230 V halogen - 1,000 VA max ELV halogen, fluorescent bulb with ballast - 500 W max with compact fluorescent light and LED Recommended fixing height: 2.50 m Fixed directly to a false ceiling with mounting claws (provided) or installed in Batibox flush-mounting box with depth of 50mm Surface mounted with accessory Cat.No 0 488 75 Infrared and ultrasonic detector 360° This dual technology allows presence to be detected precisely as soon as the wave issued by the detector is modified Consumption 0.8 W on standby</p>
5	0 785 20	 <p><b>Illuminated signalling</b> For flush-mounted installation use plate Cat.No 0 788 22 and support Cat.No 0 802 51 2 choices of power rating (0.2 W or 1 W) Signalling with white LEDs 2 modules</p>	10	0 787 15	 <p><b>Push-button</b> For controlling the false ceiling detector switch in vacancy sensing For installation next to the bathroom door Fast connection via automatic terminals, no tool required For flush-mounted installation use plate Cat.No 0 787 22 and support Cat.No 0 802 51 White antimicrobial</p>
1	0 785 10	 <p>For 230 V - 0.2 or 1 W illuminated standby To be installed in skirting trunking or bedhead strip 230 V - 2 modules White antimicrobial</p>			
1	0 785 22	 <p><b>Illuminated signalling for top of door</b> Signalling with white LEDs (1 W) Mechanism incorporating LEDs and a pivoting window which can take pre-printed labels Option of downloading labels from e-catalogue for printing 5 modules For flush-mounted installation use plate Cat.No 0 788 15 and support Cat.No 0 802 52</p>			



# Isolating transformers for hospitals

protected



Conform to standard IEC EN 61558-2-15

IP 21

The main requirements of this standard, additionally to IEC 61558-2-4, concern:

- secondary/earth leakage current, limited to 0.5 mA off-load
- inrush current, limited to 12 times the peak value of primary current
- Electrostatic shield linked to dedicated terminal
- Equipped with a temperature monitoring system (bi-metal strips), and outputs on dedicated terminals, for connection to a control system (optical, acoustic, etc.)

Pack	Cat.Nos	Single-phase		
		<b>Primary: 230 V</b>		
		<b>Secondary: 230 V with centre tap</b>		
		Output (kVA)	Terminal primary flexible cable (mm <sup>2</sup> )	secondary flexible cable (mm <sup>2</sup> )
1	0 425 71	2.5	16	16
1	0 425 72	4	16	16
1	0 425 73	5	35	35
1	0 425 74	6.3	35	35
1	0 425 75	8	35	35
1	0 425 76	10	35	35



Pack	Cat.Nos	3-phase		
		<b>Primary: 400 V <math>\Upsilon</math> + N</b>		
		<b>Secondary: 230 V <math>\Upsilon</math> + N</b>		
		Output (kVA)	Terminal primary flexible cable (mm <sup>2</sup> )	secondary flexible cable (mm <sup>2</sup> )
1	0 425 81	4	10	10
1	0 425 83	6.3	10	16
1	0 425 84	8	16	35
1	0 425 85	10	16	35



# Isolating transformers for hospitals

protected

## Characteristics

### Single-phase

Insulation voltages:

- Between windings: 3550 V
- Between primary and earth: 1770 V
- Between secondary and earth: 1770 V

Class I

Insulation: class B for 2500 VA model, ambient temperature 25 °C  
class H from 4 kVA upwards, ambient temperature 25 °C  
IP 21 - IK 08 (enclosed)

### 3-phase

Insulation voltages:

- Between windings: 4450 V
- Between primary and earth: 2250 V
- Between secondary and earth: 1770 V

Class I

Insulation: class H from 4 kVA upwards, ambient temperature 25 °C  
IP 21 - IK 08 (enclosed)

Cat.Nos 0 425 71 to 76 and 0 425 81 to 85

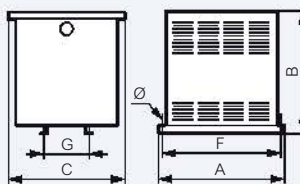

### 230 V/230 V with centre tap (single-phase)

Cat. Nos	No-load loss (W)	Drop voltage (%)		Terminals		Efficiency		Usc (%)	Dimensions (mm)			Fixing (mm)		Weight (kg)	
		cos $\phi$ 1	cos $\phi$ 0.45	Prim. mm <sup>2</sup>	Sec. mm <sup>2</sup>	cos $\phi$ 1	cos $\phi$ 0.45		A	B	C	F	G		$\emptyset$
0 425 71	22.3	3.6	1.7	16	16	0.96	0.91	3.1	320	330	253	300	111	9	36
0 425 72	46	4.4	2	16	16	0.95	0.89	3.2	340	410	370	320	120	9	52
0 425 73	54.5	3.0	1.4	35	35	0.96	0.91	2.8	340	410	370	320	150	9	67
0 425 74	67.7	3.2	1.5	35	35	0.96	0.91	2.8	340	410	370	320	150	9	68
0 425 75	85.7	2.8	1.3	35	35	0.96	0.92	2.9	340	410	370	320	180	9	77
0 425 76	87	4.2	1.9	35	35	0.95	0.90	3.5	340	410	370	320	180	9	78

### 400 V $\Upsilon$ + N / 230 V $\Upsilon$ + N (3-phase)

Cat. Nos	No-load loss (W)	Drop voltage (%)		Terminals		Efficiency		Usc (%)	Dimensions (mm)			Fixing (mm)		Weight (kg)	
		cos $\phi$ 1	cos $\phi$ 0.45	Prim. mm <sup>2</sup>	Sec. mm <sup>2</sup>	cos $\phi$ 1	cos $\phi$ 0.45		A	B	C	F	G		$\emptyset$
0 425 81	50.2	3.2	1.5	10	10	0.94	0.88	3.2	420	270	190	400	126	9	55
0 425 83	76.2	3.7	1.7	10	16	0.95	0.90	2.8	470	410	340	450	126	9	79
0 425 84	96.1	3.5	1.6	16	35	0.95	0.90	2.8	470	410	340	450	176	9	106
0 425 85	124	3.7	1.7	16	35	0.95	0.90	2.9	470	410	340	450	176	9	107

IEC EN 61558-2-15 transformer with 400 V single-phase primary,  
**Please, consult us**

Protection equipment for IEC EN 61558-2-15 power supply lines,  
**see e-catalogue**

# Discover & download our documents:

[www.docexport.legrand.com](http://www.docexport.legrand.com)



## > Power, protection devices and energy quality

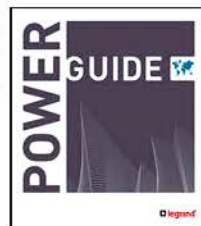

Power Guide



DPX<sup>3</sup> brochure



DX<sup>3</sup> Din-rail equipment



TX<sup>3</sup> Din-rail equipment



UPS general catalogue



Green transformers

## > Energy distribution and enclosures



Distribution systems guide



XL<sup>3</sup>-N cabinets



Zucchini busbars



Tempra Pro industrial sockets



DCX-M



Energy compensation

> Digital building infrastructures



Digital building infrastructures



CCTV brochure



Switch sensors design and application guide



Integrated workstation solutions



Workstations solutions

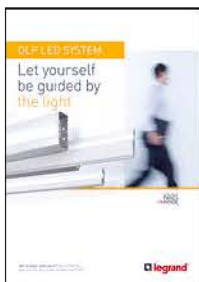

DLP LED system

> International wiring devices and Home systems



Arteor



Mallia



Belanko



Valena



Forix



Kaptika

> Integrated solutions for global projects



Healthcare facilities



Hospitality buildings



Office buildings



Data Centers



Food industry



Sfera



D45 system

 <b>NF</b> (France)  <b>voltage surge protectors</b> 0 039 40 41 43 21 23 25 27 <b>transformer DX</b> 0 042 25 <b>push-button DX</b> 0 044 53 54 55 58 63 64 68 <b>fuse carriers</b> 0 058 10 11 12 13 14 20 21 22 23 24 <b>cartridge fuses</b> 0 103 06 0 113 10 0 114 10 0 116 16 0 117 16 0 123 20 0 124 20 0 126 25 0 127 25 0 133 32 0 134 32 <b>DLP trunking</b> 0 104 24 27 62 63 64 67 70 0 105 80 82 83 84 0 106 01 02 05 06 19 21 22 35 38 50 81 82 86 91 96 0 107 00 01 02 03 10 11 22 32 35 36 37 39 40 67 84 08 85 09 10 86 92 98 0 108 00 01 02 13 23 27 33 47 54 55 56 58 60 92 93 94 96 98 <b>DL Plus mini-trunking</b> 0 300 07 08 14 15	0 300 27 33 34 0 301 14 0 308 04 <b>terminal strips</b> 0 342 11 13 15 0 039 40 41 19 43 21 23 25 27 <b>connection terminals</b> 0 343 22 23 25 28 <b>Lina 25 cable ducting</b> 0 362 00 01 02 03 05 06 07 08 09 20 21 27 31 51 52 55 67 70 0 105 80 82 83 84 0 106 01 02 05 06 19 21 22 35 38 50 81 82 86 91 96 0 107 00 01 02 03 10 11 22 32 35 36 37 39 40 67 84 08 85 09 10 86 92 98 0 108 00 01 02 13 23 27 33 47 54 55 56 58 60 92 93 94 96 98 <b>DL Plus mini-trunking</b> 0 300 07 08 14 15	0 372 79 80 81 82 83 84 85 86 <b>power supplies</b> 0 405 09 0 634 35 <b>detector</b> 0 405 27 28 <b>sounders</b> 0 405 80 86 87 94 96 98 0 415 07 <b>latching relays</b> 0 491 20 21 <b>16 A plugs and extensions</b> 0 501 62 63 64 65 10 11 12 13 16 17 25 <b>terminal blocks Viking 3</b> 0 371 00 01 02 04 05 09 38 40 51 52 55 67 70 71 77 <b>20 A socket outlets</b> 0 557 03 06 <b>32 A socket outlets</b> 0 558 72 75 77 <b>bulkhead lights</b> 0 604 50 51 58 59 77 83 84 0 624 00 02 10 12 15 20 25 49 <b>shaverlights</b> 0 606 20 21 25 28 <b>Mosaic</b> 0 676 64 65 66 68 0 766 66 0 770 00 01 02 10 11 12 21 25 26 28 30 32 40 41 42 43 47 48	0 770 50 52 60 62 63 64 70 71 92 94 95 99 0 782 04 61 68 72 05 07 30 51 89 90 91 92 94 95 99 0 892 46 <b>surface-mounting wiring</b> 0 860 01 06 <b>Plexo 66</b> 0 904 71 <b>Plexo 55</b> 0 916 55 56 <b>switches DX<sup>3</sup></b> 4 064 00 01 03 04 17 20 21 22 23 24 25 26 0 788 01 02 03 04 06 08 10 11 14 15 16 18 22 23 25 28 30 32 36 37 38 40 54 56 64 66 72 73 74 80 82 83 84 0 790 01 02 03 04 08 10 11 14 15 16 18 22 23 25 28 30 32 36 37 38 41 42 44 49 51 52 53 54 57 61 68 74 75 77 80 83 84 0 801 08 24 26 28 29 41 49 51 52 53 54 57 58 59 60 61 62 64 66 68 69 74 76 78 80 81 82 83 84	0 695 55 79 80 82 91 92 94 95 99 0 892 46 <b>surface-mounting wiring</b> 0 860 01 06 <b>Plexo 66</b> 0 904 71 <b>Plexo 55</b> 0 916 55 56 <b>switches DX<sup>3</sup></b> 4 064 00 01 03 04 17 20 21 22 23 24 25 26 0 788 01 02 03 04 06 08 10 11 14 15 16 18 22 23 25 28 30 32 36 37 38 40 54 56 64 66 72 73 74 80 82 83 84 0 801 08 24 26 28 29 41 49 51 52 53 54 57 61 68 74 75 77 80 83 84	0 802 85 86 89 90 91 92 94 95 96 97 98 4 111 49 50 51 57 58 59 60 61 62 63 64 71 72 73 74 75 76 77 78 85 86 87 88 89 90 91 92 95 06 07 08 09 10 11 12 13 14 15 16 4 112 04 05 06 07 08 09 10 11 12 13 14 15 16 17 18 19 20 21 22 23 24 25 26 27 28 29 30 31 32 33 34 35 36 37 38 39 40 41 42 43 44 45 46 47 <b>MCBs DX<sup>3</sup></b> 4 077 34 35 36 38 40 42 43 44 45 46 <b>RCBO DX<sup>3</sup></b> 4 104 01 02 03 04 14 15 16 17 18 19 20 21 22 23 24 25 26 27 28 29 30 31 32 35 37 38 40 41 42 44 48 49 51 52 53 54 55 56 57 59 60 61 62 63 64 65 66 67 68 69 70 71 72 73 74 75 76 77 78 79 80 81 82 83 84	4 110 48 50 51 52 53 54 55 59 95 96 97 98 4 111 49 50 51 57 58 59 60 61 62 63 64 71 72 73 74 75 76 77 78 85 86 87 88 89 90 91 92 95 06 07 08 09 10 11 12 13 14 15 16 4 112 04 05 06 07 08 09 10 11 12 13 14 15 16 17 18 19 20 21 22 23 24 25 26 27 28 29 30 31 32 33 34 35 36 37 38 39 40 41 42 43 44 45 46 47 <b>RCCB DX<sup>3</sup></b> 4 115 00 01 04 05 06 07 08 09 10 11 12 13 14 15 16 17 18 19 20 21 22 23 24 25 26 27 28 29 30 31 32 33 34 35 36 37 38 39 40 41 42 43 44 45 46 47 <b>transcab cable ducting</b> 6 360 95 96 6 361 00 01 02 03 04 05 06 07 08 09 10 11 12 13 14 15 16 17 18 19 20 21 22 23 24 25 26 27 28 29 30 31 32 33 34 35 36 37 38 39 40 41 42 43 44 45 46 47 <b>conduits</b> 6 510 16 20 25 32 40 45 50 55 60 61 62 63 64 65 66 67 68 69 70 71 72 73 79 80 81 82 83 84	4 117 82 83 89 90 91 92 93 99 01 <b>latching relays CX<sup>3</sup></b> 4 124 00 01 04 05 08 10 11 12 14 16 <b>contactors CX<sup>3</sup></b> 4 125 03 05 09 10 14 15 16 17 18 19 20 21 22 23 24 27 28 29 30 31 32 33 34 <b>Niléo</b> 6 643 01 35 6 645 00 03 07 09 10 11 12 14 16 6 647 01 02 04 05 08 09 10 11 12 13 14 15 16 17 18 19 20 21 22 23 24 25 26 27 28 29 30 31 32 33 34 35 36 37 38 39 40 41 42 43 44 45 46 47 48 49 50 51 52 53 54 55 56 57 58 59 60 61 62 63 64 65 66 67 68 69 70 71 72 73 74 75 76 77 78 79 80 81 82 83 84 85 86 87 88 89 90 91 92 93 94 95 96 97 98 99 00 <b>transformers</b> 4 130 91 92 93 96 98 <b>transcab cable ducting</b> 6 360 95 96 6 361 00 01 02 03 04 05 06 07 08 09 10 11 12 13 14 15 16 17 18 19 20 21 22 23 24 25 26 27 28 29 30 31 32 33 34 35 36 37 38 39 40 41 42 43 44 45 46 47 48 49 50 51 52 53 54 55 56 57 58 59 60 61 62 63 <b>transcab cable ducting</b> 6 360 95 96 6 361 00 01 02 03 04 05 06 07 08 09 10 11 12 13 14 15 16 17 18 19 20 21 22 23 24 25 26 27 28 29 30 31 32 33 34 35 36 37 38 39 40 41 42 43 44 45 46 47 48 49 50 51 52 53 54 55 56 57 58 59 60 61 62 63 <b>transcab cable ducting</b> 6 360 95 96 6 361 00 01 02 03 04 05 06 07 08 09 10 11 12 13 14 15 16 17 18 19 20 21 22 23 24 25 26 27 28 29 30 31 32 33 34 35 36 37 38 39 40 41 42 43 44 45 46 47 48 49 50 51 52 53 54 55 56 57 58 59 60 61 62 63 <b>transcab cable ducting</b> 6 360 95 96 6 361 00 01 02 03 04 05 06 07 08 09 10 11 12 13 14 15 16 17 18 19 20 21 22 23 24 25 26 27 28 29 30 31 32 33 34 35 36 37 38 39 40 41 42 43 44 45 46 47 48 49 50 51 52 53 54 55 56 57 58 59 60 61 62 63 <b>transcab cable ducting</b> 6 360 95 96 6 361 00 01 02 03 04 05 06 07 08 09 10 11 12 13 14 15 16 17 18 19 20 21 22 23 24 25 26 27 28 29 30 31 32 33 34 35 36 37 38 39 40 41 42 43 44 45 46 47 48 49 50 51 52 53 54 55 56 57 58 59 60 61 62 63 <b>transcab cable ducting</b> 6 360 95 96 6 361 00 01 02 03 04 05 06 07 08 09 10 11 12 13 14 15 16 17 18 19 20 21 22 23 24 25 26 27 28 29 30 31 32 33 34 35 36 37 38 39 40 41 42 43 44 45 46 47 48 49 50 51 52 53 54 55 56 57 58 59 60 61 62 63 <b>transcab cable ducting</b> 6 360 95 96 6 361 00 01 02 03 04 05 06 07 08 09 10 11 12 13 14 15 16 17 18 19 20 21 22 23 24 25 26 27 28 29 30 31 32 33 34 35 36 37 38 39 40 41 42 43 44 45 46 47 48 49 50 51 52 53 54 55 56 57 58 59 60 61 62 63 <b>transcab cable ducting</b> 6 360 95 96 6 361 00 01 02 03 04 05 06 07 08 09 10 11 12 13 14 15 16 17 18 19 20 21 22 23 24 25 26 27 28 29 30 31 
---	---	--	--	--	--	--	--

These products obtained on January 1<sup>st</sup> 2014, the following approvals

0 166 50	0 239 26	0 277 58	0 371 77	4 110 97	0 696 39	7 743 48	7 719 19	<b>Plexo</b>	<b>CSA</b> (Canada)	6 362 01	<b>VDE</b> (Germany)
55	27	60	78	98	40	49	21	0 695 51		02	
0 168 35	28	62	79	4 111 57	51	7 744 01	22	0 696 21	<b>cam switches</b>	06	
40	29	64	80	58	56	02	23	51		07	
45	30	66	81	59	61	04	24	61		08	
50	31	67	82	60	68	05	25	66		12	
55	32	68	83	61	72	06	26	78		13	
0 171 50	34	69	84	62	78	07	27	78		17	<b>MCBs DX</b>
55	40	70	85	63	81	08	28	0 275 34		25	0 032 66
60	43	71	86	64	83	10	29	35			68
65	50	72	98	71	85	11	31	81			69
0 173 50	51	73	99	72	89	12	32	83			70
55	52	75	0 372 00	73	90	13	33	85			71
60	53	76	01	74	91	14	34	89			72
65	54	77	02	75	92	15	35	90			73
0 176 60	60	78	03	76	94	25	36	91			74
65	61	79	04	77	96	26	37	92			75
70	63	80	07	78	0 697 11	28	38	94			76
75	80	81	08	85	12	45	39	96			0 033 08
0 178 60	82	82	09	86	13	48	41	0 707 21			10
65	83	83	10	87	15	49	42	41			11
70	84	84	11	88	20		43	42			12
75	85	85	12	89	22		44	43			13
0 199 02	03	20	20	90	33	<b>Galea Life</b>	44	44			14
42	04	21	21	91	0 698 11	7 710 01	45	45			15
43	11	40	40	92	21	02	46	46			16
44	12	0 355 00	41	93	22	03	47	47			17
45	31	01	42	94	23	04	48	48			18
46	32	02	43	05	24	05	49	49			19
47	33	03	44	06	25	06	50	50			20
48	35	04	45	07	26	07	51	51			21
49	36	05	46	08	27	08	52	52			22
50	37	06	47	09	28	09	53	53			23
51	41	07	48	10	29	10	54	54			24
0 214 04	42	08	49	11	30	30	55	55			25
05	43	09	50	12	31	31	56	56			26
0 215 04	51	10	51	13	32	32	57	57			27
05	52	12	52	14	33	33	58	58			28
0 216 04	53	14	53	15	34	34	59	59			29
05	54	15	54	16	35	35	60	60			30
<b>Vistop</b>	55	17	55	17	36	36	61	61			31
0 224 98	56	18	56	18	37	37	62	62			32
0 225 00	57	20	57	19	38	38	63	63			33
02	58	21	58	20	39	39	64	64			34
03	59	22	59	21	40	40	65	65			35
05	60	23	60	22	41	41	66	66			36
07	61	24	61	23	42	42	67	67			37
12	62	26	62	24	43	43	68	68			38
15	63	27	63	25	44	44	69	69			39
16	64	28	64	26	45	45	70	70			40
18	65	29	65	27	46	46	71	71			41
20	66	30	66	28	47	47	72	72			42
22	67	31	67	29	48	48	73	73			43
25	68	32	68	30	49	49	74	74			44
27	69	33	69	31	50	50	75	75			45
34	70	34	70	32	51	51	76	76			46
39	71	35	71	33	52	52	77	77			47
44	72	36	72	34	53	53	78	78			48
46	73	37	73	35	54	54	79	79			49
51	74	38	74	36	55	55	80	80			50
53	75	39	75	37	56	56	81	81			51
54	76	40	76	38	57	57	82	82			52
56	77	41	77	39	58	58	83	83			53
<b>Osmoz</b>	78	42	78	40	59	59	84	84			54
0 229 01	79	43	79	41	60	60	85	85			55
02	80	44	80	42	61	61	86	86			56
03	81	45	81	43	62	62	87	87			57
10	82	46	82	44	63	63	88	88			58
11	83	47	83	45	64	64	89	89			59
12	84	48	84	46	65	65	90	90			60
13	85	49	85	47	66	66	91	91			61
14	86	50	86	48	67	67	92	92			62
20	87	51	87	49	68	68	93	93			63
21	88	52	88	50	69	69	94	94			64
22	89	53	89	51	70	70	95	95			65
23	90	54	90	52	71	71	96	96			66
24	91	55	91	53	72	72	97	97			67
40	92	56	92	54	73	73	98	98			68
41	93	57	93	55	74	74	99	99			69
42	94	58	94	56	75	75	0 372 00	01			70
43	95	59	95	57	76	76	02	02			71
44	96	60	96	58	77	77	03	03			72
0 238 00	70	61	97	59	78	78	04	04			73
01	71	62	98	60	79	79	05	05			74
02	72	63	99	61	80	80	06	06			75
03	73	64	0 362 50	62	81	81	07	07			76
04	74	65	51	63	82	82	08	08			77
06	75	66	52	64	83	83	09	09			78
08	76	67	53	65	84	84	10	10			79
09	77	68	54	66	85	85	11	11			80
11	78	69	55	67	86	86	12	12			81
12	79	70	56	68	87	87	13	13			82
13	80	71	57	69	88	88	14	14			83
21	81	72	58	70	89	89	15	15			84
22	82	73	59	71	90	90	16	16			85
24	83	74	60	72	91	91	17	17			86
85	84	75	61	73	92	92	18	18			87
91	85	76	62	74	93	93	19	19			88
92	86	77	63	75	94	94	20	20			89
94	87	78	64	76	95	95	21	21			90
95	88	79	65	77	96	96	22	22			91
0 239 01	89	80	66	78	97	97	23	23			92
02	90	81	67	79	98	98	24	24			93
03	91	82	68	80	99	99	25	25			94
04	92	83	69	81	0 503 15	16	26	26			95
09	93	84	70	82	17	17	27	27			96
15	94	85	71	83	18	18	28	28			97
21	95	86	72	84	19	19	29	29			98
22	96	87	73	85	20	20	30	30			99
23	97	88	74	86	21	21	31	31			
24	98	89	75	87	22	22	32	32			
	99	90	76	88	23	23	33	33			
	0 275 34	91	77	89	24	24	34	34			
	0 277 10	92	78	90	25	25	35	35			
	0 371 00	93	79	91	26	26	36	36			
	0 372 00	94	80	92	27	27	37	37			
	0 860 01	95	81	93	28	28	38	38			
	6 643 01	96	82	94	29	29	39	39			
	6 645 00	97	83	95	30	30	40	40			
	6 646 00	98	84	96	31	31	41	41			
	6 647 01	99	85	97	32	32	42	42			
	6 648 01	0 355 00	86	98	33	33	43	43			
	6 649 01	01	87	99	34	34	44	44			
	6 650 00										

0 044 54	4 020 29	4 079 30	4 092 05	6 648 25	7 715 01	7 756 95	6 946 24	0 107 36	0 372 83	0 342 21	0 302 24
55	30	31	06	31	02	7 758 01	26	67	84	23	26
58	32	32	07	32	03	02	27	85	85	25	51
63	33	33	08	46	04	03	29	89	86	27	53
64	34	34	47	47	05	05	34	0 108 00			54
66	36	63	48	91	06	06	36	01	<b>power supply</b>	<b>connection terminals</b>	81
37	64	64	49	98	07	07	37	02	0 634 35	0 343 22	83
terminal strips	65	65	51	99	08	08	39	0 109 10			90
0 342 11	62	67	52	6 650 00	09	10	41	27	<b>Vela</b>		91
15	63	69	53	01	40	11	43	0 300 27	0 728 42	23	92
17	64	71	54	02	62	13	46	33	43	25	93
19	66	72	55	03	63	15	47	0 301 14	44	28	0 303 00
21	67	73	56	04	64	16	48	0 308 04	46		01
23	68	74	57	05	01	17	51	0 313 50	6 805 30		02
25	70	75	58	11	02	18	56	51	31		03
27	71	76	59	12	03	22	64	52	41		16
	72	77	60	13	04	25	66	6 373 58	42		26
terminal blocks	74	4 080 23	4 093 29	14	05	27			43		36
Viking 3	75	24	30	15	06	45		<b>Galea Life</b>	<b>terminal strips</b>		0 306 67
0 372 10	RCCB TX <sup>3</sup>	25	31	21	07	46	7 701 00	7 701 00	0 342 11	6 826 01	0 307 03
11	4 030 00	27	33	22	08	58	27	27	16		07
12	31	31	34	23	09	67	7 710 30	7 710 30	13		42
70	32	32	35	24	11		31	31	15		94
71	33	33	36	25	12		31	31	17		95
72	34	34	37	26	13		33	33	19		96
73	35	35	38	27	14		44	44	21		97
74	36	36	39	28	15		45	45	23		0 312 02
79	37	37	40	29	16		46	46	25		03
	38	38	41	30	17		47	47	27		07
latching relays	81	83	42	91	18		48	48	44		10
0 491 20		85		92	19		7 712 24	7 712 24	46		43
21		87		98	21		30	30	46		0 314 04
		89		99	22		31	31	60		08
		90		6 651 95	23		33	33	61		14
		91		6 652 95	24		34	34	62		18
		92			25		7 713 24	7 713 24	28		56
		93			26		30	30	30		66
		94			27		31	31	31		0 316 94
		95			28		33	33	69		95
		96			29		7 714 24	7 714 24	70		96
		97			31		30	30	74		0 333 17
		98			32		31	31	01		25
		99			33		31	31	02		27
		0 576 69			34		33	33	03		29
		72			35		7 715 24	7 715 24	04		30
		75			36		30	30	05		
		76			37		31	31	07		
					38		7 770 24	7 770 24	08		
					39		Suno	Suno	09		
					41		7 742 02	7 742 02	20		
					42		48	48	21		
					43				30		
					44				31		
					45				51		
					46				52		
					47				55		
					48				56		
					49				60		
					51				61		
					52				62		
					53				63		
					54				64		
					55				65		
					56				66		
					57				67		
					58				68		
					59				69		
					61				70		
					62				71		
					63				72		
					64				73		
					65				74		
					66				75		
					67				76		
					68				77		
					69				78		
					70				79		
					71				80		
					72				81		
					73				82		
					74				83		
					75				84		
					76				85		
					77				86		
					78				87		
					79				88		
					80				89		
					81				90		
					82				91		
					83				92		
					84				93		
					85				94		
					86				95		
					87				96		
					88				97		
					89				98		
					90				99		
					91				0 576 69		
					92				72		
					93				75		
					94				76		
					95				79		
					96				83		
					97				85		
					98				86		
					99				87		
					0 491 20				88		
					21				89		
					22				90		
					23				91		
					24				92		
					25				93		
					26				94		
					27				95		
					28				96		
					29				97		
					30				98		
					31				99		
					32				0 491 20		
					33				05		
					34				06		
					35				11		
					36				12		
					37				13		
					38				14		
					39				15		
					40				16		
					41				17		
					42				18		
					43				19		
					44				20		
					45				21		
					46				22		
					47				23		
					48				24		
					49				25		
					50				26		
					51				27		
					52				28		
					53				29		
					54				30		
					55				31		
					56				32		
					57				33		
					58				34		
					59				35		
					60				36		
					61				37		







These products benefit on January 1<sup>st</sup> 2014, from PEP (Product Environmental Profile)

0 379 42	0 383 09	0 405 87	0 696 72	0 775 09	0 801 28	4 020 24	4 078 00	4 090 67	4 101 48	4 110 97	4 117 79	6 037 78
43	10	90	78	11	40	25	01	68	49	98	80	79
44	11	91	81	0 778 11	41	26	02	69	50	4 111 85	81	6 038 00
54	12	0 407 47	83	12	49	27	03	70	51	86	82	01
55	13	49	85	13	51	28	04	71	52	87	83	02
56	14	0 415 07	89	14	55	29	05	08	53	88	84	03
57	15	0 416 47	90	22	82	30	06	07	54	89	85	04
58	16	0 442 01	91	31	85	32	51	09	60	4 112 04	86	6 170 00
59	17	02	92	32	0 802 50	33	52	11	61	05	87	01
60	18	03	94	33	51	34	53	12	62	06	89	02
0 380 09	19	04	96	35	52	36	55	13	63	07	90	03
0 381 00	20	05	0 697 11	36	53	37	57	14	64	08	91	04
01	21	06	12	37	54	38	59	15	65	33	92	05
02	22	11	13	41	59	62	60	16	66	34	93	06
03	23	12	22	42	61	63	61	17	67	35	4 118 00	07
04	24	13	31	43	64	64	62	18	73	36	01	41
05	25	14	40	44	66	66	63	19	74	37	4 124 04	42
06	30	15	80	51	68	67	64	20	75	38	05	43
07	31	16	0 698 21	52	69	68	65	95	76	39	08	46
08	32	17	31	53	74	70	4 079 20	96	77	40	10	47
09	33	18	61	90	76	71	21	97	78	41	11	49
10	34	31	70	92	78	72	22	99	79	42	12	6 373 58
11	35	32	0 756 01	97	80	74	24	4 092 00	80	4 115 00	14	6 463 50
12	36	33	02	0 784 07	81	75	26	01	86	02	16	54
13	37	34	03	0 787 02	82	76	28	02	87	04	4 125 03	62
14	38	35	04	10	83	4 030 00	29	03	88	05	09	66
15	39	36	06	11	84	01	30	04	89	06	10	68
16	40	37	08	12	85	02	31	05	90	07	10	69
17	41	38	09	14	86	04	32	06	91	08	14	70
18	42	39	11	15	89	05	33	07	92	09	17	71
19	43	40	12	16	0 896 05	06	34	08	93	10	21	72
20	44	41	13	20	06	08	63	47	99	11	23	73
21	45	42	14	21	10	09	64	48	4 102 00	12	24	80
22	46	43	16	22	11	10	65	49	01	14	33	83
23	47	44	21	23	15	35	66	51	02	15	35	6 643 01
24	48	45	22	24	16	36	67	52	03	16	36	35
25	49	46	23	25	20	38	69	53	04	17	44	6 645 00
26	50	47	24	26	21	39	71	54	12	19	51	07
27	51	48	26	80	25	40	72	55	13	20	58	20
28	52	49	31	82	26	42	73	56	14	21	61	22
29	53	50	32	0 788 01	30	43	74	57	15	22	4 126 02	40
30	54	51	33	02	31	44	75	58	16	24	30	6 646 00
31	55	52	34	03	32	4 062 58	76	59	17	25	31	07
32	60	53	36	04	0 904 71	60	77	60	18	26	33	20
33	61	54	41	06	78	62	4 080 23	4 093 29	19	27	41	6 647 01
34	62	55	42	08	0 919 10	66	24	30	25	28	4 130 91	02
35	63	56	43	10	11	76	25	31	26	29	92	40
40	64	57	44	11	14	78	27	33	27	30	93	02
41	65	0 462 00	46	14	15	80	29	34	28	31	5 720 05	05
42	66	02	41	15	16	82	31	35	29	32	13	08
43	67	03	62	16	17	87	32	36	30	37	5 721 11	09
44	68	06	63	18	0 920 32	88	33	37	31	43	17	10
45	69	07	66	22	42	89	34	38	32	50	18	13
46	70	09	67	23	52	91	35	39	33	52	30	14
50	71	11	69	25	62	4 065 27	36	40	02	54	45	35
51	72	12	71	28	82	28	37	41	14	55	5 722 30	6 648 01
52	73	13	72	30	92	35	81	42	14	56	5 725 05	02
53	74	14	75	32	0 921 26	36	82	43	24	57	13	05
54	75	0 463 00	76	36	36	44	83	59	26	59	5 726 11	08
55	76	06	81	37	38	43	85	60	28	60	17	09
60	77	12	88	38	0 955 01	4 074 25	87	61	29	61	30	10
61	78	18	90	54	03	26	89	62	31	62	30	13
62	79	19	0 765 41	56	05	27	90	63	32	64	45	14
63	80	21	42	64	06	29	91	64	35	65	49	14
64	81	22	44	66	07	30	92	72	71	66	72	35
65	82	23	46	80	08	32	93	73	72	67	5 727 30	6 650 01
0 382 10	83	28	51	0 790 01	09	33	94	74	74	69	30	02
11	84	29	55	02	10	34	95	75	75	70	15	03
12	85	0 470 21	61	03	11	35	4 081 43	76	77	71	30	11
13	0 384 00	22	62	04	12	36	45	77	80	72	31	12
14	01	23	64	06	13	37	47	84	83	74	31	13
16	02	24	65	08	14	38	48	85	86	75	15	21
17	03	25	73	10	15	49	4 075 02	86	99	76	30	22
18	04	0 473 62	76	14	16	50	03	87	4 105 00	77	31	23
19	05	63	81	15	17	04	51	88	11	90	70	31
20	06	91	82	16	18	06	52	89	12	91	71	32
21	07	92	83	18	19	07	53	90	21	92	72	33
22	08	0 488 00	0 766 40	22	0 968 00	09	4 088 65	97	23	4 117 02	5 751 00	33
23	09	03	41	23	01	10	66	98	25	03	01	7 741 15
24	10	06	42	25	03	11	67	99	26	04	02	7 742 15
25	11	07	0 767 20	28	05	12	68	0 098 00	28	05	03	7 743 01
26	12	08	0 770 00	30	06	13	69	01	29	07	04	06
27	13	09	01	32	07	14	70	02	31	08	05	07
28	14	17	02	36	08	15	71	03	34	09	06	13
29	15	20	11	37	09	54	72	07	55	10	5 752 00	21
30	16	21	12	38	20	55	73	08	76	12	01	22
31	17	22	21	72	21	56	74	09	83	13	02	23
32	18	23	25	73	22	58	75	10	4 106 05	14	10	51
33	19	24	26	74	23	59	76	11	08	15	11	52
34	20	25	30	0 792 01	24	61	77	12	11	17	12	53
35	21	30	31	02	25	62	78	13	36	18	13	54
36	22	41	32	07	26	63	4 089 35	14	40	19	14	55
37	23	42	40	11	27	64	36	15	43	20	15	56
38	24	44	41	12	28	65	37	16	57	22	16	57
39	25	50	42	25	29	66	39	23	58	23	5 756 10	57
70	26	0 503 40	43	26	0 980 00	67	40	24	59	24	11	72
71	27	41	44	30	01	01	4 076 17	41	33	4 109 93	25	73
72	28	42	50	32	03	18	42	34	97	27	5 760 01	7 744 01
73	29	43	52	42	05	19	43	35	99	28	02	06
74	30	0 512 21	60	70	06	21	44	36	4 110 00	29	03	07
75	31	0 522 04	62	07	22	45	45	37	02	30	5 761 00	13
76	32	0 676 64	70	0 794 51	08	24	46	38	03	32	08	21
80	33	66	72	52	09	25	47	39	04	33	18	22
81	34	67	73	54	20	26	48	40	05	34	20	23
82	35	68	74	55	21	27	84	41	06	35	21	23
83	40	0 695 11	75	61	22	28	85	42	21	37	22	51
84	41	12	92	62	23	29	86	46	22	45	23	52
85	42	13	0 772 11	64	24	30	88	47	24	46	24	53
86	43	24	12	65	25	62	89	48	25	59	25	54
90	45	25	13	73	26	63	90	49	26	60	27	55
91	46	30	14	76	27	64	91	50	27	61	28	56
92	50	40	16	0 800 40	28	66	92	51	28	62	5 762 00	57
93	52	42	17	41	29	68	93	52	41	64	01	61
94	54	51	18	42	4 016 76	70	94	53	47	65	02	62
95	55	79	19	43	77	71	95	54	48	66	03	63
96	56	80	20	44	78	72	96	55	50	67	04	64
0 383 00	60	82	31	49	79	73	97	56	51	69	05	65
01	62	0 696 11	45	51	4 018 61	74	4 090 58	57	52	70	06	66
02	64	12	0 775 01	52	62	75	59	36	53	71	07	67
03	65	13	03	53	63	76	60	37	54	72	08	7 821 00
04	66	21	0									



# Legrand

worldwide



## KLINKMANN

### Helsinki

tel. +358 9 540 4940  
automation@klinkmann.fi

### St. Petersburg

tel. +7 812 327 3752  
klinkmann@klinkmann.spb.ru

### Moscow

tel. +7 495 641 1616  
moscow@klinkmann.spb.ru

### Yekaterinburg

tel. +7 343 376 5393  
yekaterinburg@klinkmann.spb.ru

### Mineralnye Vody

tel. +7 87922 6 19 34  
pyatigorsk@klinkmann.spb.ru

### Samara

tel. +7 846 342 6655  
samara@klinkmann.spb.ru

### Kiev

tel. +38 044 495 3340  
klinkmann@klinkmann.kiev.ua

### Riga

tel. +371 6738 1617  
klinkmann@klinkmann.lv

### Vilnius

tel. +370 5 215 1646  
post@klinkmann.lt

### Tallinn

tel. +372 668 4500  
klinkmann.est@klinkmann.ee

### Minsk

tel. +375 17 200 0876  
minsk@klinkmann.com